

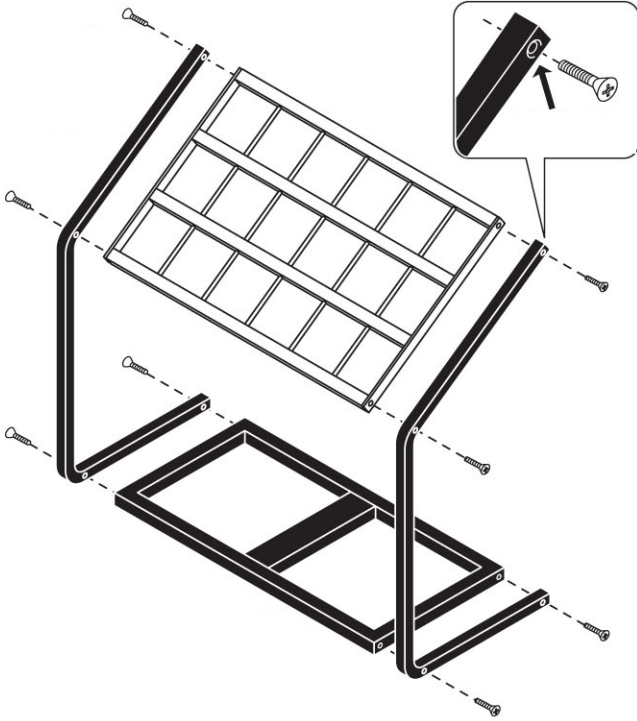

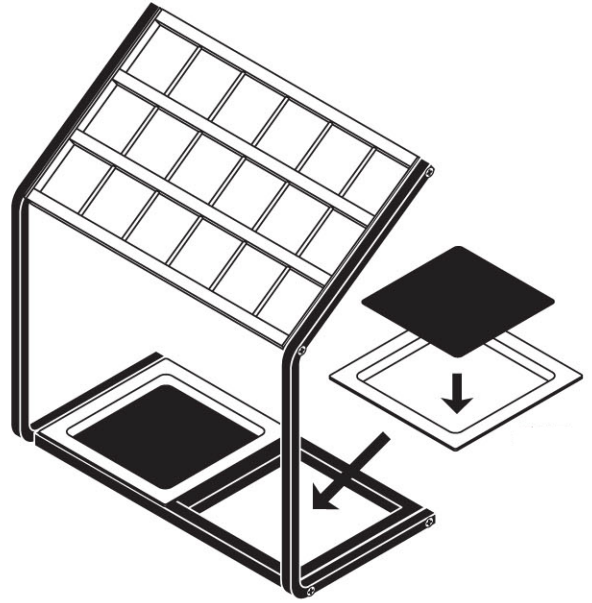
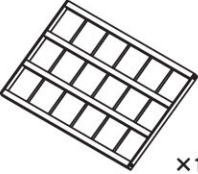
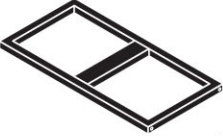
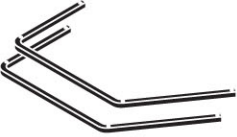
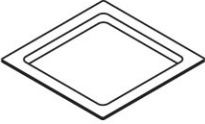

1**2**

Top Panel	Bottom Panel	Frame (Left & Right)	Screw	Base Plate	Mat
 ×1	 ×1	 ×1	 ×8	 ×2	 ×2