

FINAL DRAWING

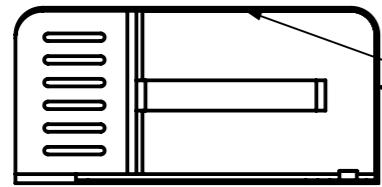

Smooth laser welded (grinded) 2x20mm

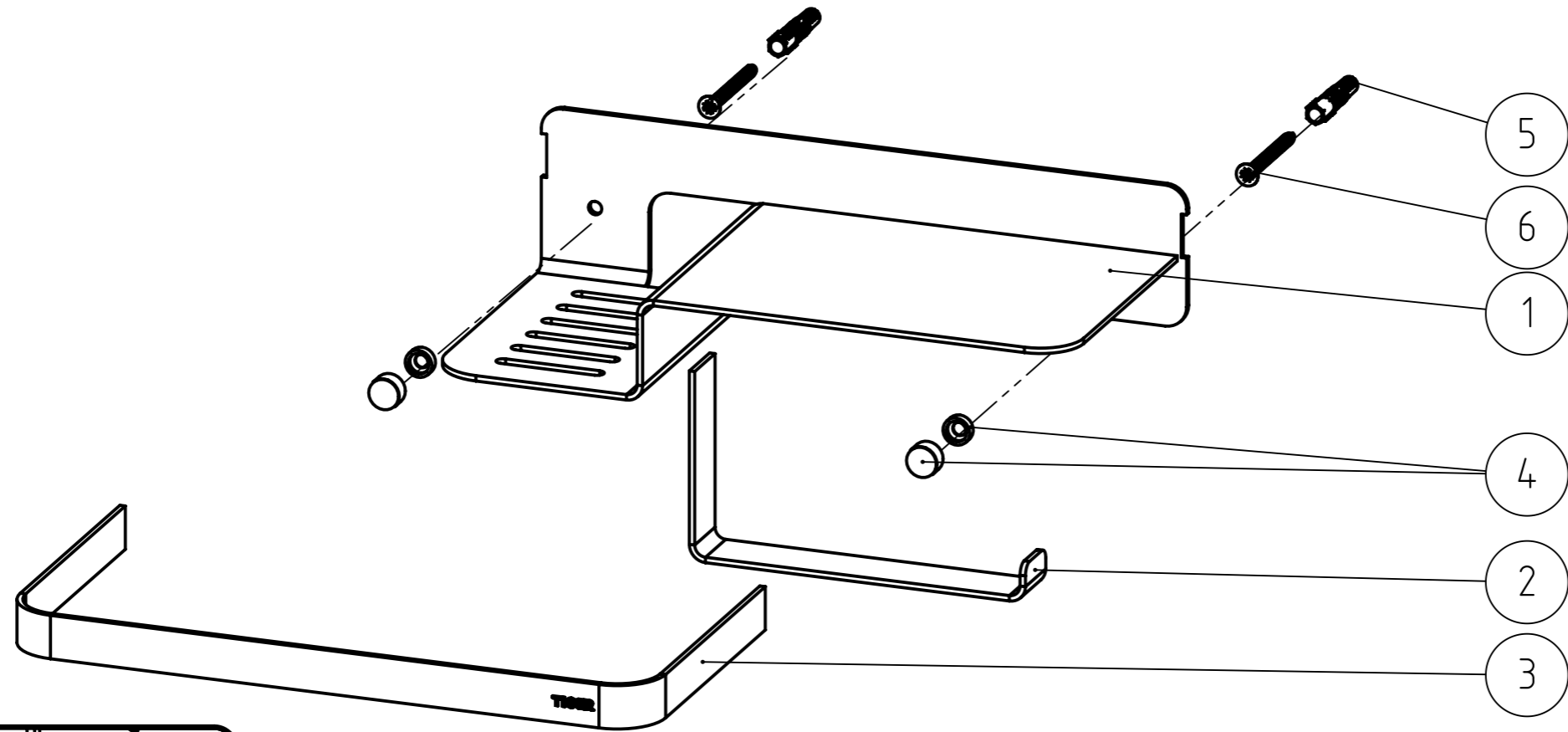
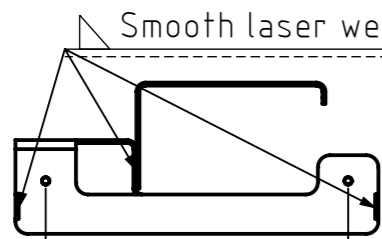

Smooth laser welding (grinded)

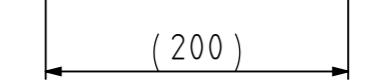

(200)

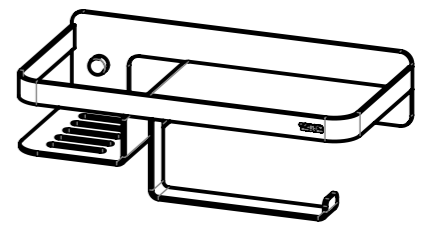
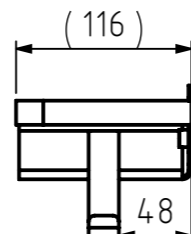
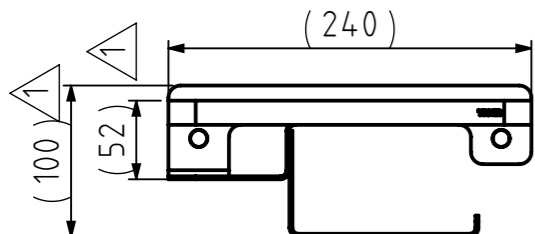
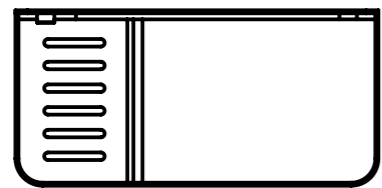

Remarks:
- Avoid welding marks

NR.	DESCRIPTION	QTY.	DRAW.NR.	MATERIAL	TREATMENT
6	Cross recessed countersunk head tapping screw	2	DIN.7982 CZ	Stainless steel A2	-
5	Fischer UX6 plug	2	FIX.0028	Nylon	-
4	Screw cap assembly (11,5x6,2mm)	2	BUY.15.00	-	Powder coated, texture VDI 3400 ref.30 - RAL 9005 (Jet black)
3	Strip	1	207.07.03	Stainless steel AISI 430	Powder coated, texture VDI 3400 ref.30 - RAL 9005 (Jet black)
2	Arm	1	207.07.02	Stainless steel AISI 430	Powder coated, texture VDI 3400 ref.30 - RAL 9005 (Jet black)
1	Toilet roll holder	1	207.07.01	Stainless steel AISI 430	Powder coated, texture VDI 3400 ref.30 - RAL 9005 (Jet black)

GENERAL DIMENSION UNLESS OTHERWISE STATED ACCORDING TO DIN 7168		DESCRIPTION:																										
<table border="1"> <thead> <tr> <th rowspan="2">CLASS</th> <th colspan="7">NOMINAL MEASUREMENTS (mm)</th> </tr> <tr> <th>0.5 UNTIL 3</th> <th>3 UNTIL 6</th> <th>6 UNTIL 30</th> <th>30 UNTIL 120</th> <th>120 UNTIL 400</th> <th>400 UNTIL 1000</th> <th>1000 UNTIL 2000</th> <th>2000 UNTIL 4000</th> </tr> </thead> <tbody> <tr> <td>M (MIDDLE)</td> <td>±0.1</td> <td>±0.1</td> <td>±0.2</td> <td>±0.3</td> <td>±0.5</td> <td>±0.8</td> <td>±1.2</td> <td>±2</td> </tr> </tbody> </table>		CLASS	NOMINAL MEASUREMENTS (mm)							0.5 UNTIL 3	3 UNTIL 6	6 UNTIL 30	30 UNTIL 120	120 UNTIL 400	400 UNTIL 1000	1000 UNTIL 2000	2000 UNTIL 4000	M (MIDDLE)	±0.1	±0.1	±0.2	±0.3	±0.5	±0.8	±1.2	±2	<p>DESCRIPTION: Toilet roll holder</p>	
CLASS	NOMINAL MEASUREMENTS (mm)																											
	0.5 UNTIL 3	3 UNTIL 6	6 UNTIL 30	30 UNTIL 120	120 UNTIL 400	400 UNTIL 1000	1000 UNTIL 2000	2000 UNTIL 4000																				
M (MIDDLE)	±0.1	±0.1	±0.2	±0.3	±0.5	±0.8	±1.2	±2																				
<p>PROJECTION: </p>		<p>VERSION NAME: black</p>																										
<p>GENERAL ANGLE: ±0,5°</p>		<p>ARTICLE NR.: 1401430746</p>																										
<p>EAN: 4008911401424</p>		<p>PROJECT: 207-Caddy</p>																										
<p>DRAWN BY: FVP</p>		<p>DRAWING NR.: 207.07.00.TB</p>																										
<p>CHECKED BY: MS</p>		<p>Tiger Nederland b.v. Winde 3, PO box 11 5660 AA Geldrop The Netherlands</p>																										
<p>DATE: 30-1-2020</p>		<p>GENERAL ROUGHNESS: 0,8</p>																										
<p>STATUS: Production</p>		<p>UNITS: mm</p>																										
<p>PRINT DATE: 8-4-2025</p>		<p>SCALE: 1:5</p>																										
<p>INT.REV.NR.: 00</p>		<p>FORMAT: A3</p>																										
		<p>SHEET: 3/3</p>																										

The reproduction, distribution and utilization of this document as well as the communication of its contents to others without express authorization is prohibited. Offenders will be held liable for the payment of damages. All rights reserved in the event of the grant of a patent, utility model or design. Copyright reserved.