

Suction cup VL40FC, 3/8"NPT-1/4"NPSF

Article number: 0202717



- Suitable for flat or slightly corrugated or curved surfaces
- Good stability and little inherent movement
- Recommended when the lifting force is parallel to the surface of the object
- Cleats prevent thin, sensitive objects from being deformed and gives extra friction when the lifting force is parallel
- Volume discounts available for big packs from 30-99 pieces with an even larger discount for big packs of 100 pieces and above
- PVC-free recyclable material

Technical data

Description	Unit	Value
Suction cup shape	-	Flat Concave
Suction cup design	-	Round
Material	-	TPE
Suction cup model	-	FC
Height (B)	mm	27
Height 2 (D)	mm	15
Inner diameter (C)	mm	10
Outer diameter, min. (A)	mm	40
Fitting size	-	3/8", 1/4"
Fitting option	-	None
Fitting style	-	Female/Male
Fitting type	-	NPT-thread, NPSF-thread
Suction cup model	-	VL40FC TPE-U

Performance - Lifting forces

VL40FC TPE-U	Vertical (N)	Parallel (N)
50 -kPa	38 N	

Material

Name	TPE-U
Colour	Purple
Temperature, min. °C	0
Temperature max. °C	60
Hardness °Shore A	65

Material resistance

Alcohol	n/a
Concentrated acids	n/a
Ethanol	n/a
Hydrolysis	n/a
Methanol	n/a
Oil	n/a
Oxidation	n/a
Petrol	n/a
Wear resistance	n/a
Weather and ozone	n/a

Dimensional drawings

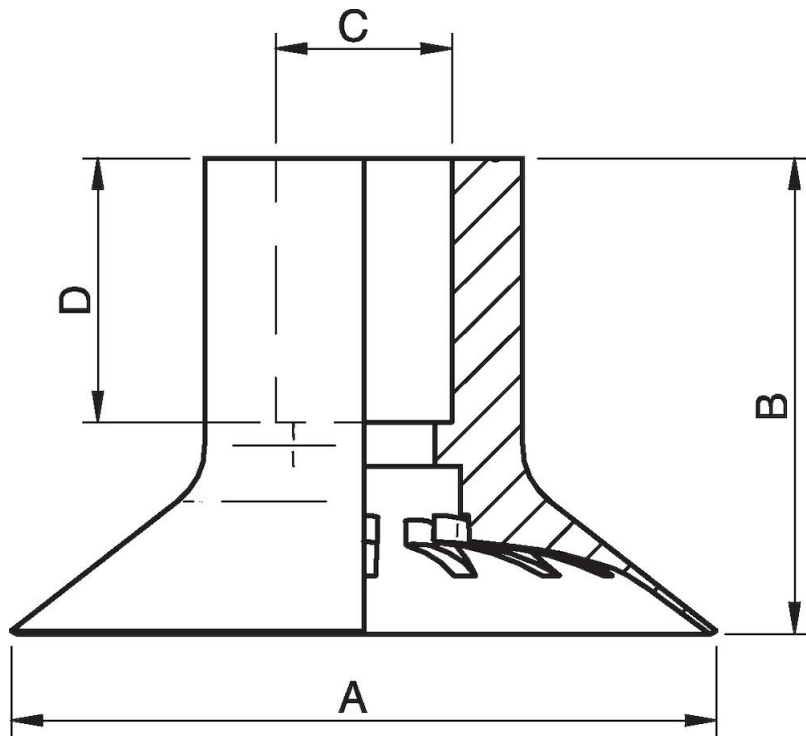

Values specified in this data sheet are tested at (unless otherwise stated):

- Room temperature (20°C [68°F] ± 3°C [5.5°F]).
- Standard atmosphere (101.3 [29.9 inHg] ± 1.0 kPa [0.3 inHg]).
- Relative humidity 20-70%.
- Compressed air quality, DIN ISO 8573-1 class 4.

Accessories

0202158 | Fitting VL D=Ø10, G1/4" - G1/8"

0202164 | Fitting VL D=Ø10, G3/8" - G1/4"

0202162 | Fitting VL D=Ø10, 1/4" NPT - 1/8" NPSF

Spare parts

0202100 | Suction cup VL40FC

0202166 | Fitting VL D=Ø10, 3/8" NPT - 1/4" NPSF