

Suction cup BXF60P Polyurethane 60, G3/8" female plastic thread

Article number: 0207530



- Special designed friction cup with multi bellows for oily metal sheets. Suitable for application where great level compensation is needed such as de-stacking sheets from magazines (press-line) and picking car body parts from racks.
- Very low vacuum level needed to fully compress the extra-long bellows causes the cup not to push away parts from position.
- The "BXF" design is suitable for flat as well as uneven/curved surfaces.
- Internal friction pattern on the lip can withstand high shear forces, typically 3–5 times more than corresponding conventional suction cups.
- Best choice if > 0.1g/m2 press oil is used on the sheet but also a great choice for dry metal sheets.
- DURAFLEX® is a material that features the elasticity of rubber and wear resistance of polyurethane. The material has a fantastic elastic memory, even after hundreds of thousand cycles.

Technical data

Description	Unit	Value
Suction cup shape	-	Bellows
Application	-	Oily sheet metal
Suction cup design	-	Round
Characteristics	-	Oily sheet metal
Material	-	Polyurethane (PU)
Weight, min.	g	35.2
Suction cup model	-	BXF
Volume	cm ³	80
Height	mm	62.9
Outer diameter, min.	mm	60
Outer diameter, actuated	mm	61.7
Fitting size	-	3/8"
Fitting option	-	None
Fitting style	-	Female
Fitting type	-	G-thread
Material	-	PA
Suction cup model	-	BXF60P Dry metal sheet
Movement, vertical max.	mm	31.8
Curve radius, min.	mm	70
Suction cup model	-	BXF60P Oily metal sheet
Movement, vertical max.	mm	31.8
Curve radius, min.	mm	70

Performance - Lifting forces

	Vertical (N)	Parallel (N)
BXF60P Dry metal sheet		
60 -kPa	88	47
90 -kPa	122	50
BXF60P Oily metal sheet		
60 -kPa	82	43
90 -kPa	115	46

Material

Name	Polyurethane (PU60)
Colour	Orange
Temperature, min. °C	10
Temperature max. °C	50
Hardness °Shore A	60

Material resistance

Alcohol	n/a
Concentrated acids	Fair
Ethanol	Fair
Hydrolysis	Fair
Methanol	Poor
Oil	Excellent
Oxidation	Poor
Petrol	Fair
Wear resistance	Excellent
Weather and ozone	Excellent

Dimensional drawings

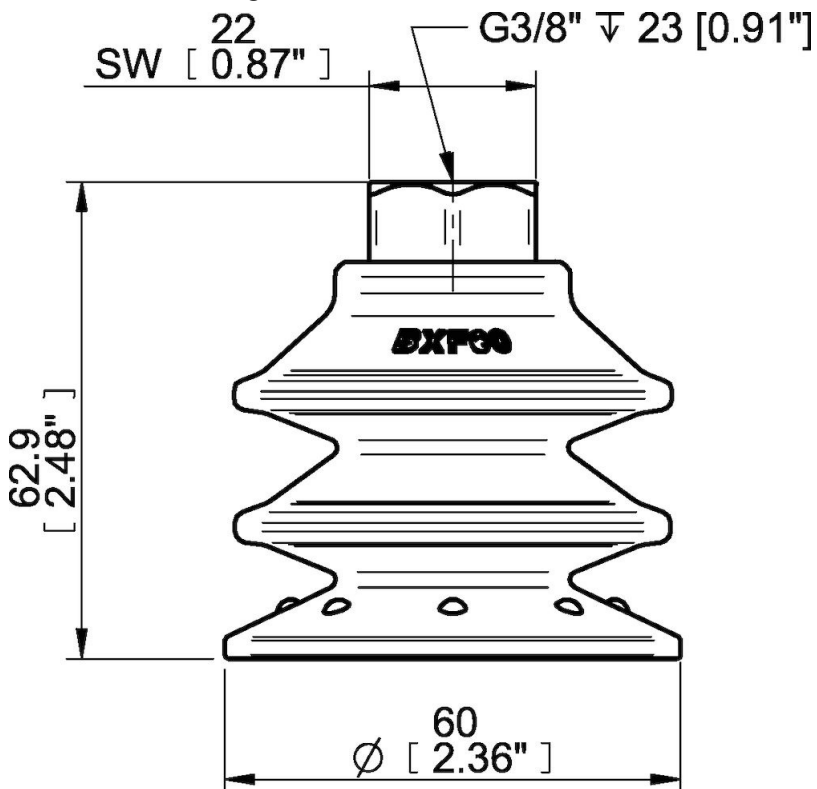

Values specified in this data sheet are tested at (unless otherwise stated):

- Room temperature (20°C [68°F] ± 3°C [5.5°F]).
- Standard atmosphere (101.3 [29.9 inHg] ± 1.0 kPa [0.3 inHg]).
- Relative humidity 20-70%.
- Compressed air quality, DIN ISO 8573-1 class 4.