

Suction cup F-BX25 Silicone 3/8" NPT male SS, detectable, FCM

Article number: 0207074



- The silicone material complies with FDA 21 CFR 177.2600 and EU 1935/2004.
- Long lasting high-end silicone material
- A low percentage metal additive (Fe) is mixed with the rubber material to make it detectable.
- Suitable for frozen and raw food.
- Excellent grip on food with irregular surfaces and different heights, even at fast speeds and accelerations
- Available with male threaded food grade, detectable plastic fittings or acid proof stainless steel fittings.
- Easy to clean with hygienic design. No dust/dirt pockets.
- Low vacuum level needed to collapse bellows. Reduces risk for damaging the handled food product

Technical data

Description	Unit	Value
Suction cup shape	-	Multibellows
Application	-	Food contact materials (FDA & EU), detectable
Suction cup design	-	Round
Characteristics	-	Food contact materials (FDA & EU), detectable
Material	-	Silicone (SIL)
Load, torque, max.	Nm	13
Weight, min.	g	27.9
Suction cup model	-	F-BX
Volume	cm ³	5.1
Height	mm	42
Outer diameter, min.	mm	26
Outer diameter, actuated	mm	26
Fitting size	-	3/8"
Fitting option	-	None
Fitting style	-	Male
Fitting type	-	NPT-thread
Tightening torque, max.	Nm	13
Material	-	ASTM 316L
Suction cup model	-	F-BX25
Movement, vertical max.	mm	15.5
Curve radius, min.	mm	9

Performance - Lifting forces

F-BX25	Vertical (N)	Parallel (N)
10 -kPa	3.9	2.9
20 -kPa	6.9	4.6
40 -kPa	8	7.3

Material

Name	Silicone (SIL detectable FCM)
Colour	Blue
Temperature, min. °C	-40
Temperature max. °C	200
Hardness °Shore A	40

Material resistance

Alcohol	Good
Concentrated acids	Poor
Ethanol	n/a
Hydrolysis	Fair
Methanol	n/a
Oil	Poor
Oxidation	Excellent
Petrol	Poor
Wear resistance	Good
Weather and ozone	Excellent

Dimensional drawings

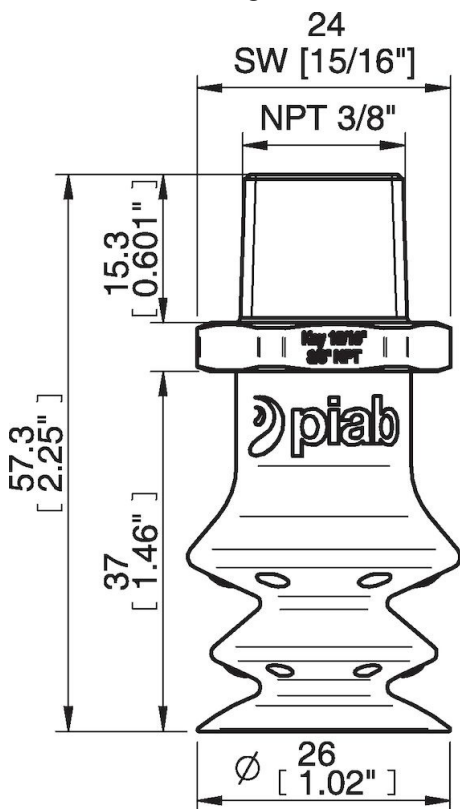

Values specified in this data sheet are tested at (unless otherwise stated):

- Room temperature (20°C [68°F] ± 3°C [5.5°F]).
- Standard atmosphere (101.3 [29.9 inHg] ± 1.0 kPa [0.3 inHg]).
- Relative humidity 20-70%.
- Compressed air quality, DIN ISO 8573-1 class 4.

Accessories

- 0207147 | Fitting G1/4" Male, SS, F-BX25-50 P-D36
- 0207148 | Fitting 1/4"NPT Male, SS, F-BX25-50 P-D36
- 0207149 | Fitting G3/8" Male, SS, F-BX25-50 P-D36
- 0207150 | Fitting 3/8"NPT Male, SS, F-BX25-50 P-D36
- 0207151 | Fitting G1/4" Male, composite, F-BX25-50 P-D36
- 0207152 | Fitting 1/4"NPT Male, composite, F-BX25-50 P-D36
- 0207153 | Fitting G3/8" Male, composite, F-BX25-50 P-D36
- 0207154 | Fitting 3/8"NPT Male, composite, F-BX25-50 P-D36

Spare parts

- 0206205 | Suction cup F-BX25 Silicone detectable, FCM
- 0207150 | Fitting 3/8"NPT Male, SS, F-BX25-50 P-D36