

Vacuum filter G1/8" (10 µm)

Article number: 3116670



- To filter dust and other small particles from the vacuum flow.
- Reduces the risk of operation breakdown or stoppage in the pump.
- Replaceable filter element.
- Available with special filter element with increased filter area

Technical data

Description	Unit	Value
Material	-	PA, PE, PP
Temperature, max.	°C	80
Temperature, min.	°C	-20
Weight, min.	g	53
Flow (nominal)	l/s	1.4
Pressure, max.	MPa	0
Filter area	cm ²	30
Pressure, min.	MPa	-0.1
Removal efficiency	µm	10
Volume, internal	cm ³	35

Dimensional drawings

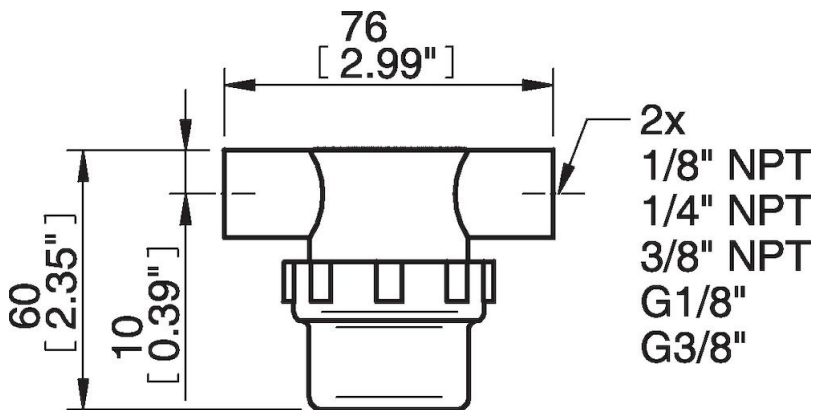

Spare parts

- 0202951 | Filter element 1/8" - 3/8" (120µm), 3pcs
- 0128421 | Filter element 1/8" & 1/4" & 3/8" (10 µm), 3 pcs