

Suction cup DCF65P Polyurethane 60 G1/4" male with mesh filter

Article number: 0207678



- Special designed friction cups for domed or flat oily surfaces, such as sheets in metal forming processes.
- Long lasting material, normal wear on friction cup will not affect the long term shear force performance.
- Best choice if > 0.1g/m² press oil is used on the sheet but also a great choice for dry metal sheets.
- Refined internal friction pattern provides additional grip performance, the suction cups can withstand high shear forces, typically 3–5 times more than corresponding conventional suction cups.
- Thin design that easily will follow convex or concave surfaces. The thin and pliable design in combination with a special inner friction pattern will maximize grip performance.
- DURAFLEX® suction cups manufactured in a specially developed material that features the elasticity of rubber and wear resistance of polyurethane. The material does not leave any marks on the objects handled and has a fantastic elastic memory, even after hundreds of thousands of cycles.

Technical data

Description	Unit	Value
Suction cup shape	-	Deep Concave
Application	-	Oily sheet metal
Suction cup design	-	Round
Characteristics	-	Oily sheet metal
Material	-	Polyurethane (PU)
Weight, min.	g	54.1
Suction cup model	-	DCF
Volume	cm ³	23.9
Height	mm	30.2
Outer diameter, min.	mm	67.5
Outer diameter, actuated	mm	72.3
Fitting size	-	1/4"
Fitting option	-	Filter mesh
Fitting style	-	Male
Fitting type	-	G-thread
Material	-	Al
Suction cup model	-	DCF65P Oily metal sheet
Movement, vertical max.	mm	9.9
Curve radius, min.	mm	95
Suction cup model	-	DCF65P Dry metal sheet
Movement, vertical max.	mm	9.9
Curve radius, min.	mm	95

Performance - Lifting forces

DCF65P Oily metal sheet	Vertical (N)	Parallel (N)
60 -kPa	141	100
90 -kPa	191	134

DCF65P Dry metal sheet

60 -kPa	143	146
90 -kPa	193	196

Material

Name	Polyurethane (PU60)
Colour	Orange
Temperature, min. °C	10
Temperature max. °C	50
Hardness °Shore A	60

Material resistance

Alcohol	n/a
Concentrated acids	Fair
Ethanol	Fair
Hydrolysis	Fair
Methanol	Poor
Oil	Excellent
Oxidation	Poor
Petrol	Fair
Wear resistance	Excellent
Weather and ozone	Excellent

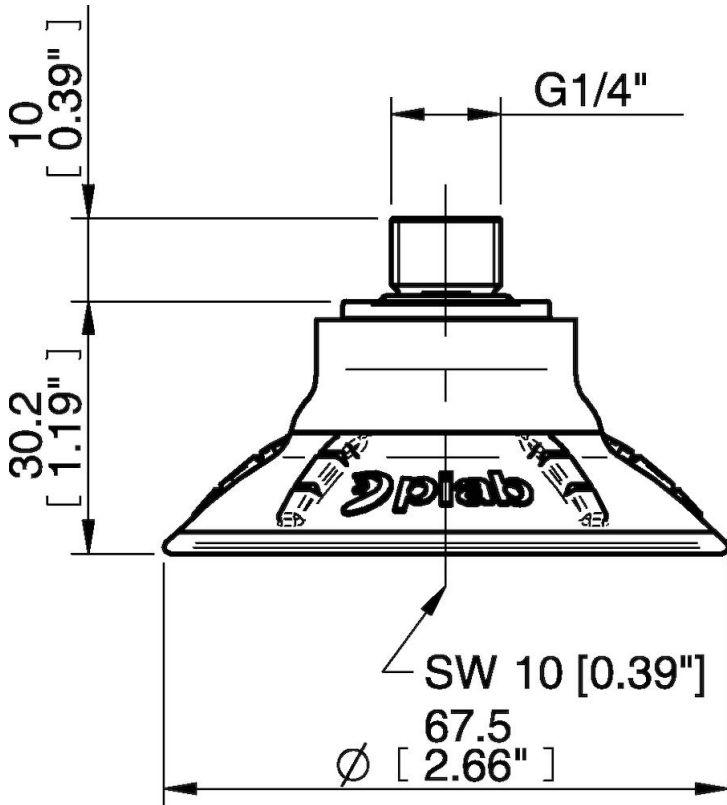
Dimensional drawings**Values specified in this data sheet are tested at (unless otherwise stated):**

- Room temperature (20°C [68°F] ± 3°C [5.5°F]).
- Standard atmosphere (101.3 [29.9 inHg] ± 1.0 kPa [0.3 inHg]).
- Relative humidity 20-70%.
- Compressed air quality, DIN ISO 8573-1 class 4.