

Suction cup BL40-3P Polyurethane 30/70, 3/8" NPT male

Article number: 0112693



- High-flow fitting allowing high initial vacuum flow needed for plastic bag handling.
- Suitable for level adjustment and uneven surfaces.
- Dual hardness allowing strength and stability in conjunction with softness and flexibility.
- DURAFLEX® material features the elasticity of rubber in combination with the wear resistance of polyurethane.
- The DURAFLEX® material is mark-free.

Technical data

Description	Unit	Value
Suction cup shape	-	Multibellows
Application	-	Bag handling
Suction cup design	-	Round
Characteristics	-	Bag handling
Material	-	Polyurethane (PU)
Weight, min.	g	12
Suction cup model	-	BL-3-P
Volume	cm ³	27
Height	mm	59.9
Outer diameter, min.	mm	40
Fitting size	-	3/8"
Fitting option	-	None
Fitting style	-	Male
Fitting type	-	NPT-thread
Suction cup model	-	BL40-3P
Movement, vertical max.	mm	21
Curve radius, min.	mm	13

Performance - Lifting forces

BL40-3P	Vertical (N)	Parallel (N)
20 -kPa	20	13
60 -kPa	43	24
90 -kPa	55	36

Material		
Name	Polyurethane (PU30)	Polyurethane (PU70)
Colour	Yellow	Black
Temperature, min. °C	10	10
Temperature max. °C	50	50
Hardness °Shore A	30	70
Material resistance		
Alcohol	n/a	n/a
Concentrated acids	Fair	Fair
Ethanol	Fair	Fair
Hydrolysis	Fair	Fair
Methanol	Poor	Poor
Oil	Excellent	Excellent
Oxidation	Poor	Poor
Petrol	Fair	Fair
Wear resistance	Excellent	Excellent
Weather and ozone	Excellent	Excellent

Dimensional drawings

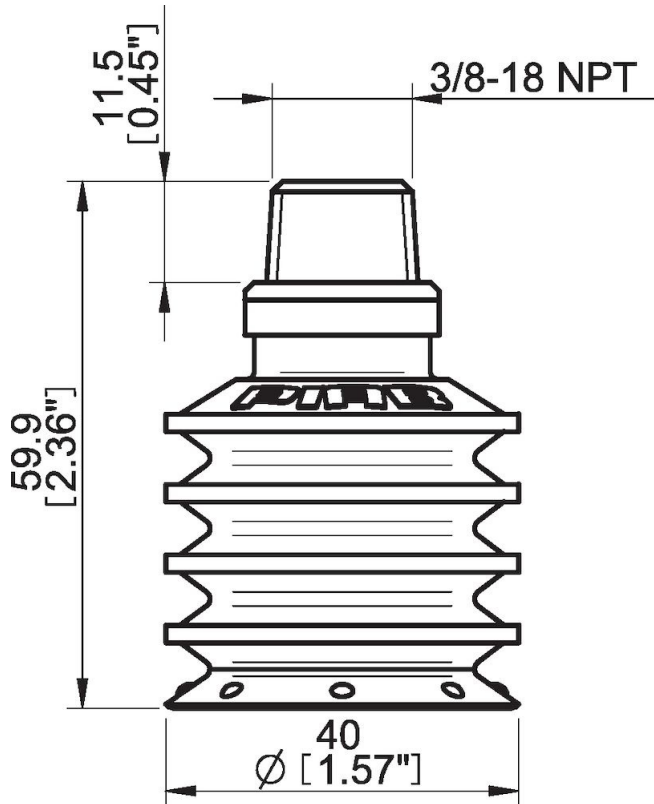

Values specified in this data sheet are tested at (unless otherwise stated):

- Room temperature (20°C [68°F] ± 3°C [5.5°F]).
- Standard atmosphere (101.3 [29.9 inHg] ± 1.0 kPa [0.3 inHg]).
- Relative humidity 20-70%.
- Compressed air quality, DIN ISO 8573-1 class 4.

Accessories

0112662 | Fitting G3/8" male, bag

Spare parts

0112667 | Suction cup BL40-3P Polyurethane 30/70

0112692 | Fitting 3/8" NPT male, bag