

Vacuum switch, pneumatic, preset (NC 30 -kPa)

Article number: 3116087

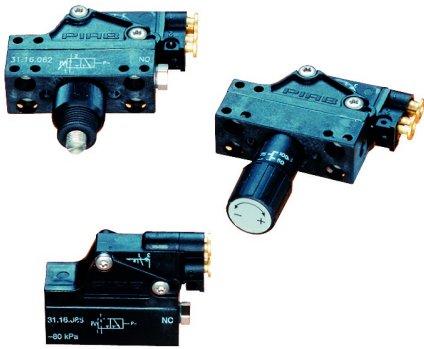

- Converts a vacuum level to a pneumatic signal.
- Vacuum-actuated membrane linked to a pneumatic switch.
- Available preset or with adjustable vacuum level.

Technical data

Description	Unit	Value
Material	-	Al, CuZn, Nitrile (NBR), PA, POM, SS
Temperature, max.	°C	60
Temperature, min.	°C	-10
Weight, min.	g	39
Feed pressure, max. (@ vacuum connection)	MPa	0.6
Valve function	-	NC
Feed pressure, optimum, max.	MPa	0.8
Feed pressure, optimum, min.	MPa	0.15
Hysteresis	kPa	12
Signal range, max.	-kPa	35
Signal range, min.	-kPa	25
Vacuum setting options	-	Preset

Dimensional drawings

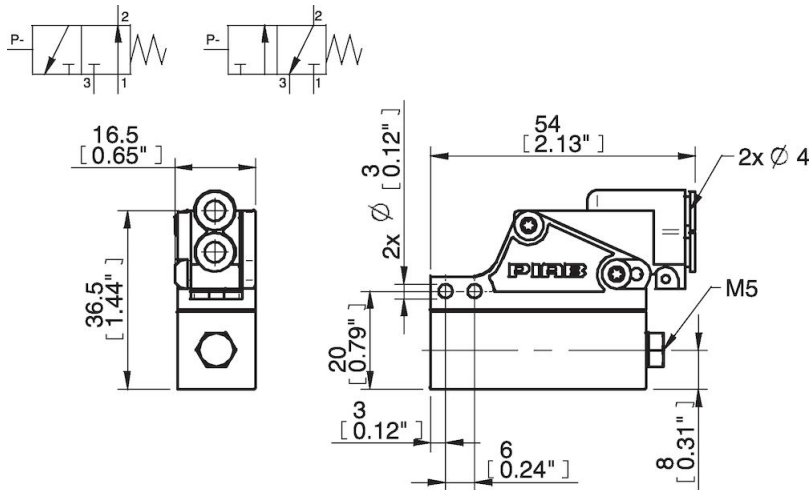

Accessories

0100488 | Connection set for vacuum switch