

# Suction cup FCF35P Polyurethane 55/60, G1/4" female

Article number: 0206921

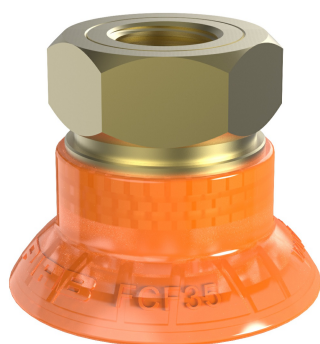

- Special designed friction cups for oily surfaces, such as sheets in metal forming processes.
- Normal wear on friction cup will not affect the long term shear force performance.
- Best choice if > 0.1g/m2 press oil is used on the sheet.
- Thanks to the strong grip on oily surfaces, the suction cups can withstand high shear forces, typically 2–4 times more than corresponding conventional suction cups.
- The "FCF" design is suitable for slightly domed and flat surfaces, e.g., such as those encountered when handling metal sheets in press lines.
- The suction cups have support cleats that prevent thin objects from being disfigured.
- DURAFLEX® suction cups manufactured in a specially developed material that features the elasticity of rubber and wear resistance of polyurethane. The material does not leave any marks on the objects handled.

## Technical data

Description	Unit	Value
Suction cup shape	-	Flat Concave
Application	-	Oily sheet metal
Suction cup design	-	Round
Characteristics	-	Oily sheet metal
Material	-	Polyurethane (PU)
Weight, min.	g	50.3
Suction cup model	-	FCF
Volume	cm <sup>3</sup>	5
Height	mm	28.5
Outer diameter, min.	mm	35
Outer diameter, actuated	mm	38.5
Fitting size	-	1/4"
Fitting style	-	Female
Fitting type	-	G-thread
Suction cup model	-	FCF35P Dry metal sheet
Movement, vertical max.	mm	2.5
Curve radius, min.	mm	40
Suction cup model	-	FCF35P Oily steel plate
Movement, vertical max.	mm	2.5
Curve radius, min.	mm	40

## Performance - Lifting forces

	Vertical (N)	Parallel (N)
FCF35P Dry metal sheet		
60 -kPa	42	30
90 -kPa	58	42
FCF35P Oily steel plate		
60 -kPa	34	26
90 -kPa	50	32

## Material

Name	Polyurethane (PU55)	Polyurethane (PU60)
Colour	Orange	Green transparent
Temperature, min.   °C	10	10
Temperature max.   °C	50	50
Hardness   °Shore A	55	60

## Material resistance

Alcohol	n/a	n/a
Concentrated acids	Fair	Fair
Ethanol	Fair	Fair
Hydrolysis	Fair	Fair
Methanol	Poor	Poor
Oil	Excellent	Excellent
Oxidation	Poor	Poor
Petrol	Fair	Fair
Wear resistance	Excellent	Excellent
Weather and ozone	Excellent	Excellent

## Dimensional drawings

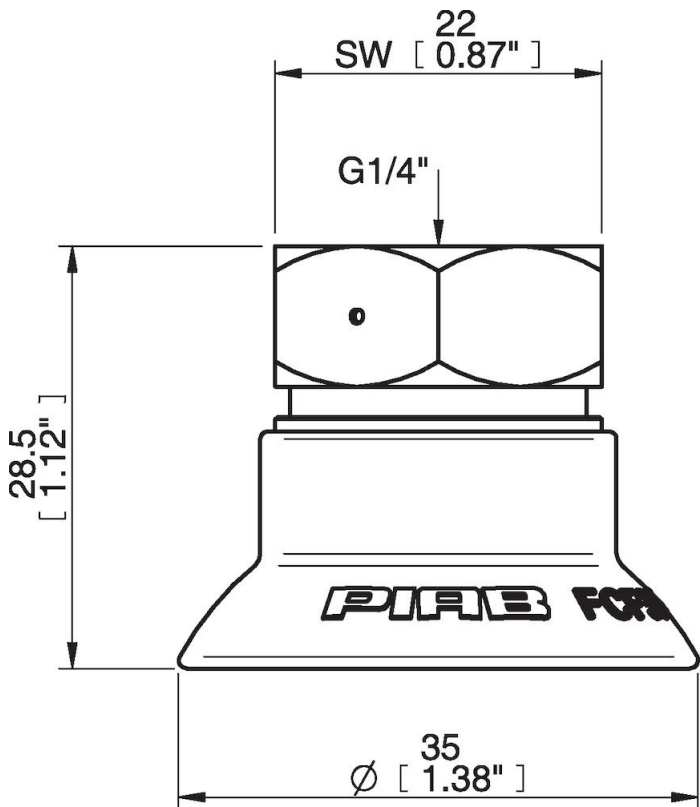

## Values specified in this data sheet are tested at (unless otherwise stated):

- Room temperature (20°C [68°F] ± 3°C [5.5°F]).
- Standard atmosphere (101.3 [29.9 inHg] ± 1.0 kPa [0.3 inHg]).
- Relative humidity 20-70%.
- Compressed air quality, DIN ISO 8573-1 class 4.