

Suction cup DCF40P Polyurethane 60, 3/8" NPT female

Article number: 0210599



- Special designed friction cups for domed or flat oily surfaces, such as sheets in metal forming processes.
- Long lasting material, normal wear on friction cup will not affect the long term shear force performance.
- Best choice if > 0.1g/m² press oil is used on the sheet but also a great choice for dry metal sheets.
- Refined internal friction pattern provides additional grip performance, the suction cups can withstand high shear forces, typically 3–5 times more than corresponding conventional suction cups.
- Thin design that easily will follow convex or concave surfaces. The thin and pliable design in combination with a special inner friction pattern will maximize grip performance.
- DURAFLEX® is a material that features the elasticity of rubber and wear resistance of polyurethane. The material has a fantastic elastic memory, even after hundreds of thousand cycles.

Technical data

Description	Unit	Value
Suction cup shape	-	Deep Concave
Application	-	Oily sheet metal
Suction cup design	-	Round
Characteristics	-	Oily sheet metal
Material	-	Polyurethane (PU)
Weight, min.	g	35.1
Suction cup model	-	DCF
Volume	cm ³	3.7049
Height	mm	31.4
Height 2 (Actuated)	mm	25.3
Outer diameter, min.	mm	40
Outer diameter, actuated	mm	42
Fitting size	-	3/8"
Fitting style	-	Female
Fitting type	-	NPT-thread
Material	-	Brass
Suction cup model	-	DCF40 Dry metal sheet
Movement, vertical max.	mm	6.1
Curve radius, min.	mm	20
Suction cup model	-	DCF40 Oily metal sheet
Movement, vertical max.	mm	6.1
Curve radius, min.	mm	20

Performance - Lifting forces

	Vertical (N)	Parallel (N)
DCF40 Dry metal sheet		
60 -kPa	43	27
90 -kPa	56	44
DCF40 Oily metal sheet		
60 -kPa	40	19
90 -kPa	55	28

Material

Name	Polyurethane (PU60)
Colour	Orange
Temperature, min. °C	10
Temperature max. °C	50
Hardness °Shore A	60

Material resistance

Alcohol	n/a
Concentrated acids	Fair
Ethanol	Fair
Hydrolysis	Fair
Methanol	Poor
Oil	Excellent
Oxidation	Poor
Petrol	Fair
Wear resistance	Excellent
Weather and ozone	Excellent

Dimensional drawings

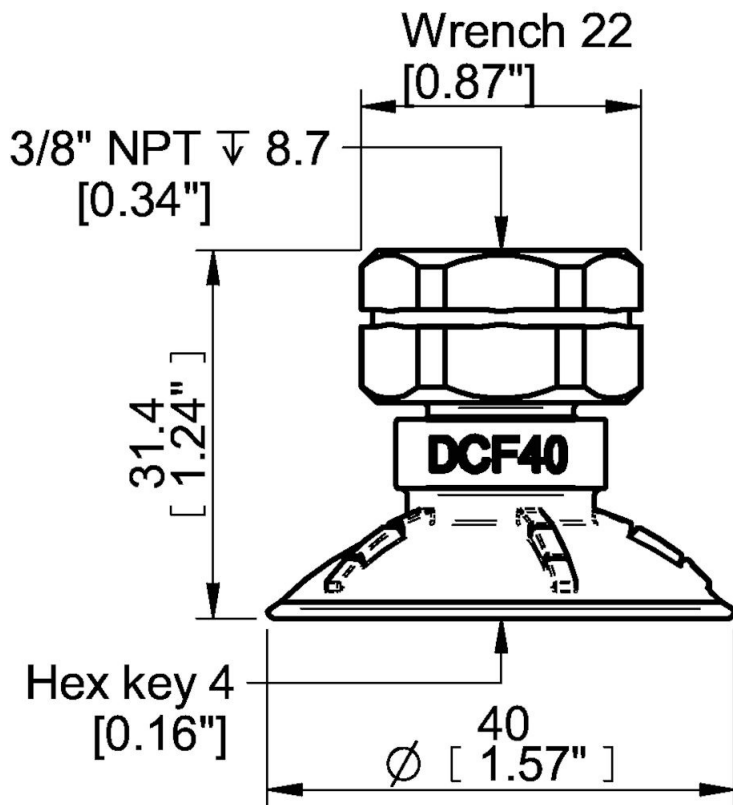

Values specified in this data sheet are tested at (unless otherwise stated):

- Room temperature (20°C [68°F] \pm 3°C [5.5°F]).
- Standard atmosphere (101.3 [29.9 inHg] \pm 1.0 kPa [0.3 inHg]).
- Relative humidity 20-70%.
- Compressed air quality, DIN ISO 8573-1 class 4.