

Suction cup F-BX20 Silicone G1/4" male composite, detectable, FCM

Article number: 0207068



- The silicone material complies with FDA 21 CFR 177.2600 and EU 1935/2004.
- Long lasting high-end silicone material
- A low percentage metal additive (Fe) is mixed with the rubber material to make it detectable.
- Suitable for frozen and raw food.
- Excellent grip on food with irregular surfaces and different heights, even at fast speeds and accelerations
- Available with male threaded food grade, detectable plastic fittings or acid proof stainless steel fittings.
- Easy to clean with hygienic design. No dust/dirt pockets.
- Low vacuum level needed to collapse bellows. Reduces risk for damaging the handled food product

Technical data

Description	Unit	Value
Suction cup shape	-	Multibellows
Application	-	Food contact materials (FDA & EU), detectable
Suction cup design	-	Round
Characteristics	-	Food contact materials (FDA & EU), detectable
Material	-	Silicone (SIL)
Load, torque, max.	Nm	13
Weight, min.	g	5.1
Suction cup model	-	F-BX
Volume	cm ³	2.9
Height	mm	35
Outer diameter, min.	mm	21
Outer diameter, actuated	mm	21
Fitting size	-	1/4"
Fitting option	-	None
Fitting style	-	Male
Fitting type	-	G-thread
Tightening torque, max.	Nm	13
Material	-	Composite
Suction cup model	-	F-BX20
Movement, vertical max.	mm	12.2
Curve radius, min.	mm	7.5

Performance - Lifting forces

F-BX20	Vertical (N)	Parallel (N)
10 -kPa	2.4	2.2
20 -kPa	4.4	2.8
40 -kPa	6.2	3.8

Material

Name	Silicone (SIL detectable FCM)
Colour	Blue
Temperature, min. °C	-40
Temperature max. °C	200
Hardness °Shore A	40

Material resistance

Alcohol	Good
Concentrated acids	Poor
Ethanol	n/a
Hydrolysis	Fair
Methanol	n/a
Oil	Poor
Oxidation	Excellent
Petrol	Poor
Wear resistance	Good
Weather and ozone	Excellent

Dimensional drawings

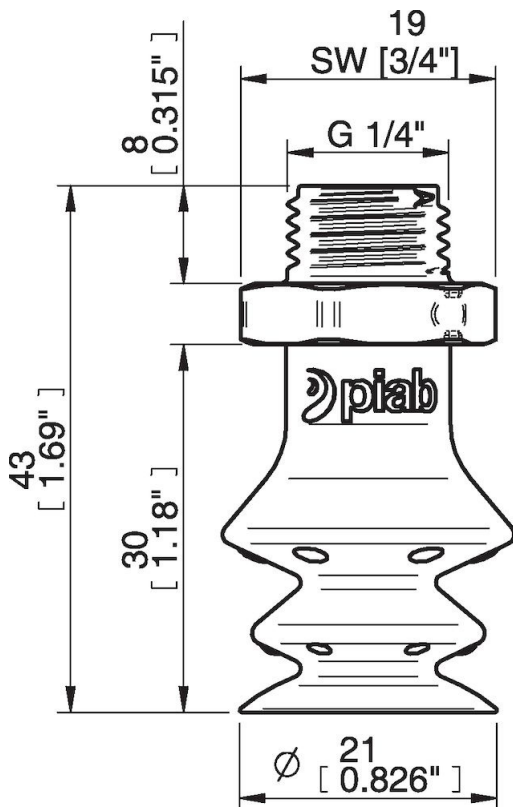

Values specified in this data sheet are tested at (unless otherwise stated):

- Room temperature (20°C [68°F] ± 3°C [5.5°F]).
- Standard atmosphere (101.3 [29.9 inHg] ± 1.0 kPa [0.3 inHg]).
- Relative humidity 20-70%.
- Compressed air quality, DIN ISO 8573-1 class 4.

Accessories

- 0207139 | Fitting G1/8" Male, SS, F-BX15-20 P-D27
- 0207140 | Fitting 1/8"NPT Male, SS, F-BX15-20 P-D27
- 0207141 | Fitting G1/4" Male, SS, F-BX15-20 P-D27
- 0207142 | Fitting 1/4"NPT Male, SS, F-BX15-20 P-D27
- 0207143 | Fitting G1/8" Male, composite, F-BX15-20 P-D27
- 0207144 | Fitting 1/8"NPT Male, composite, F-BX15-20 P-D27
- 0207145 | Fitting G1/4" Male, composite, F-BX15-20 P-D27
- 0207146 | Fitting 1/4"NPT Male, composite, F-BX15-20 P-D27

Spare parts

- 0206204 | Suction cup F-BX20 Silicone detectable, FCM
- 0207145 | Fitting G1/4" Male, composite, F-BX15-20 P-D27