

# Suction cup DCF110P Polyurethane 60, G1/4" female, with mesh filter

Article number: 0206796



- Special designed friction cups for domed or flat oily surfaces, such as sheets in metal forming processes.
- Long lasting material, normal wear on friction cup will not affect the long term shear force performance.
- Best choice if > 0.1g/m<sup>2</sup> press oil is used on the sheet but also a great choice for dry metal sheets.
- Refined internal friction pattern provides additional grip performance, the suction cups can withstand high shear forces, typically 3–5 times more than corresponding conventional suction cups.
- Thin design that easily will follow convex or concave surfaces. The thin and pliable design in combination with a special inner friction pattern will maximize grip performance.
- DURAFLEX® suction cups manufactured in a specially developed material that features the elasticity of rubber and wear resistance of polyurethane. The material does not leave any marks on the objects handled and has a fantastic elastic memory, even after hundreds of thousands of cycles.

## Technical data

Description	Unit	Value
Suction cup shape	-	Deep Concave
Application	-	Oily sheet metal
Suction cup design	-	Round
Characteristics	-	Oily sheet metal
Material	-	Polyurethane (PU)
Weight, min.	g	112.1
Suction cup model	-	DCF
Volume	cm <sup>3</sup>	110.2
Height	mm	50.6
Outer diameter, min.	mm	112.5
Outer diameter, actuated	mm	121.2
Fitting size	-	1/4"
Fitting option	-	Filter mesh
Fitting style	-	Female
Fitting type	-	G-thread
Suction cup model	-	DCF110P Oily metal sheet
Movement, vertical max.	mm	17.2
Curve radius, min.	mm	153
Suction cup model	-	DCF110P Dry metal sheet
Movement, vertical max.	mm	17.2
Curve radius, min.	mm	153

## Performance - Lifting forces

	Vertical (N)	Parallel (N)
DCF110P Oily metal sheet		
60 -kPa	313	286
90 -kPa	433	358
DCF110P Dry metal sheet		

60 -kPa	315	377
90 -kPa	436	573

**Material**

Name	Polyurethane (PU60)
Colour	Orange
Temperature, min.   °C	10
Temperature max.   °C	50
Hardness   °Shore A	60

**Material resistance**

Alcohol	n/a
Concentrated acids	Fair
Ethanol	Fair
Hydrolysis	Fair
Methanol	Poor
Oil	Excellent
Oxidation	Poor
Petrol	Fair
Wear resistance	Excellent
Weather and ozone	Excellent

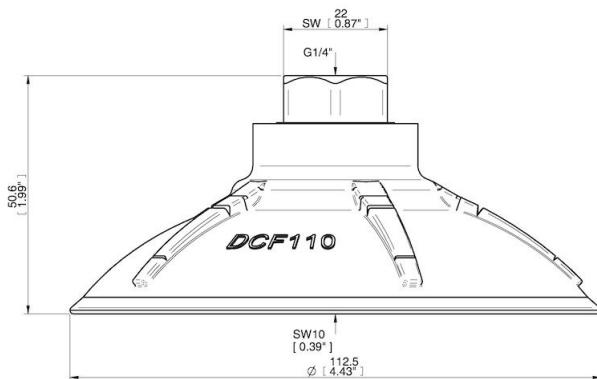
**Dimensional drawings****Values specified in this data sheet are tested at (unless otherwise stated):**

- Room temperature (20°C [68°F] ± 3°C [5.5°F]).
- Standard atmosphere (101.3 [29.9 inHg] ± 1.0 kPa [0.3 inHg]).
- Relative humidity 20-70%.
- Compressed air quality, DIN ISO 8573-1 class 4.