

Vacuum filter G3/4" (5 µm)

Article number: 0110522



- To filter dust and other small particles from the vacuum flow.
- Reduces the risk of operation breakdown or stoppage in the pump.
- Replaceable filter element.
- Available with special filter element with increased filter area

Technical data

Description	Unit	Value
Material	-	PA, Polyester, PP, SS
Temperature, max.	°C	80
Temperature, min.	°C	-20
Weight, min.	g	246
Flow (nominal)	l/s	5.8
Pressure, max.	MPa	0
Filter area	cm ²	320
Pressure, min.	MPa	-0.1
Removal efficiency	µm	5
Volume, internal	cm ³	205

Dimensional drawings

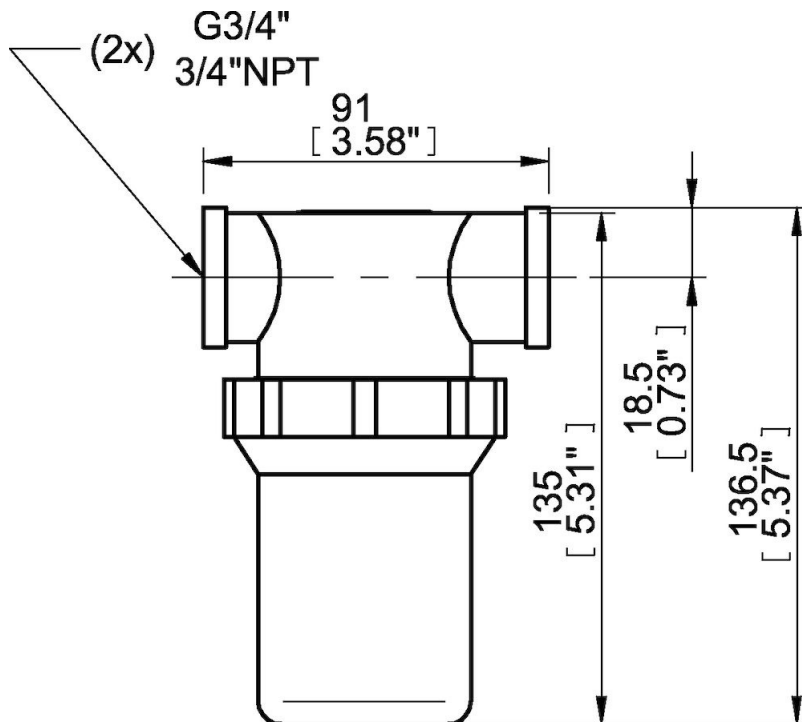

Spare parts

3116223 | Filter element 1/2" & 3/4" (5 µm)