

# Suction cup VL25BL, 1/4"NPT-1/8"NPSF

Article number: 0202701



- Suitable for level adjustment
- Lifting movement to separate small and thin objects
- Less suitable when the lifting force is parallel to the surface of the object
- Volume discounts available for big packs from 30-99 pieces with an even larger discount for big packs of 100 pieces and above
- PVC-free recycable material

## Technical data

Description	Unit	Value
Suction cup shape	-	Multibellows
Suction cup design	-	Round
Material	-	TPE
Suction cup model	-	BL
Height (B)	mm	33.5
Height 2 (D)	mm	9
Inner diameter (C)	mm	6
Outer diameter, min. (A)	mm	25
Fitting size	-	1/4", 1/8"
Fitting option	-	None
Fitting style	-	Female/Male
Fitting type	-	NPT-thread, NPSF-thread
Suction cup model	-	VL25BL TPE-U

## Performance - Lifting forces

VL25BL TPE-U	Vertical (N)	Parallel (N)
50 -kPa	11 N	

## Material

Name	TPE-U
Colour	Purple
Temperature, min.   °C	0
Temperature max.   °C	60
Hardness   °Shore A	65

## Material resistance

Alcohol	n/a
Concentrated acids	n/a
Ethanol	n/a
Hydrolysis	n/a
Methanol	n/a
Oil	n/a
Oxidation	n/a
Petrol	n/a
Wear resistance	n/a
Weather and ozone	n/a

## Dimensional drawings

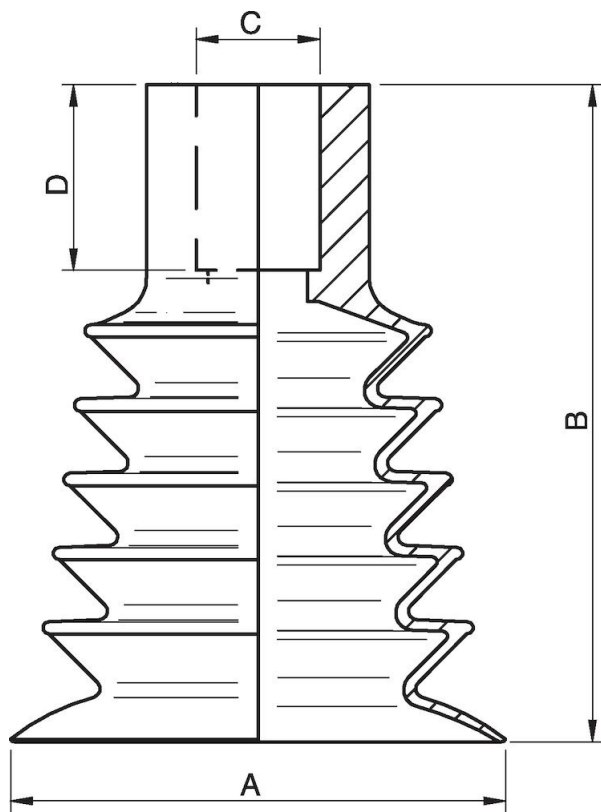

**Values specified in this data sheet are tested at (unless otherwise stated):**

- Room temperature (20°C [68°F] ± 3°C [5.5°F]).
- Standard atmosphere (101.3 [29.9 inHg] ± 1.0 kPa [0.3 inHg]).
- Relative humidity 20-70%.
- Compressed air quality, DIN ISO 8573-1 class 4.

### Accessories

- 0202156 | Fitting VL D=Ø6, G1/8" - M5
- 0202157 | Fitting VL D=Ø6, G1/4" - G1/8"
- 0202160 | Fitting VL D=Ø6, 1/8" NPT - M5

### Spare parts

- 0202161 | Fitting VL D=Ø6, 1/4" NPT - 1/8" NPSF
- 0202118 | Suction cup VL25BL