

Suction cup BFFT60P-2 Polyurethane 60/60/30, G1/4" female, with mesh filter

Article number: 0222774



- The BFFT60P-2 is an enhanced version with a slightly steadier bellows giving better performance related to BAF values, better capability to cope with shear forces and high-speed applications.
- Special designed friction cups for thin (0.6-0.8 mm) oily metal sheets, such as outer body car parts in a press-to press forming process.
- Refined internal friction pattern provides additional grip performance, the suction cups can withstand high shear forces, typically 3–5 times more than corresponding conventional suction cups.
- The "BFFT" design is suitable for thin flat or uneven/curved surfaces and if level compensation is needed, for example in de-stacking applications.
- The flat inner support, made of dual hardness, gives stability and good grip during movement in any orientation.
- DURAFLEX® suction cups manufactured in a specially developed material that features the elasticity of rubber and wear resistance of polyurethane. The material does not leave any marks on the objects handled and has a fantastic elastic memory, even after hundreds of thousands of cycles.

Technical data

Description	Unit	Value
Suction cup shape	-	Bellows
Application	-	Oily sheet metal, Dry sheet metal
Suction cup design	-	Round
Characteristics	-	Oily sheet metal, Dry sheet metal
Material	-	Polyurethane (PU)
Weight, min.	g	71.9
Suction cup model	-	BFFT
Volume	cm ³	34
Height	mm	39.8
Height 2 (Actuated)	mm	26.3
Outer diameter, min.	mm	62
Outer diameter, actuated	mm	65
Fitting size	-	1/4"
Fitting option	-	Filter mesh
Fitting style	-	Female
Fitting type	-	G-thread
Suction cup model	-	BFFT60P-2 Oily metal sheet
Movement, vertical max.	mm	13
Curve radius, min.	mm	30
Suction cup model	-	BFFT60P-2 Dry metal sheet
Movement, vertical max.	mm	13
Curve radius, min.	mm	30

Performance - Lifting forces

BFFT60P-2 Oily metal sheet	Vertical (N)	Parallel (N)
60 -kPa	129	63.4
90 -kPa	141	87.6
BFFT60P-2 Dry metal sheet		
20 -kPa	50	44.6
60 -kPa	130	82.5
90 -kPa	142.9	92.6

Material

Name	Polyurethane (PU30)	Polyurethane (PU60)	Polyurethane (PU60)
Colour	Yellow	Green transparent	Orange
Temperature, min. °C	10	10	10
Temperature max. °C	50	50	50
Hardness °Shore A	30	60	60

Material resistance

	Polyurethane (PU30)	Polyurethane (PU60)	Polyurethane (PU60)
Alcohol	n/a	n/a	n/a
Concentrated acids	Fair	Fair	Fair
Ethanol	Fair	Fair	Fair
Hydrolysis	Fair	Fair	Fair
Methanol	Poor	Poor	Poor
Oil	Excellent	Excellent	Excellent
Oxidation	Poor	Poor	Poor
Petrol	Fair	Fair	Fair
Wear resistance	Excellent	Excellent	Excellent
Weather and ozone	Excellent	Excellent	Excellent

Dimensional drawings

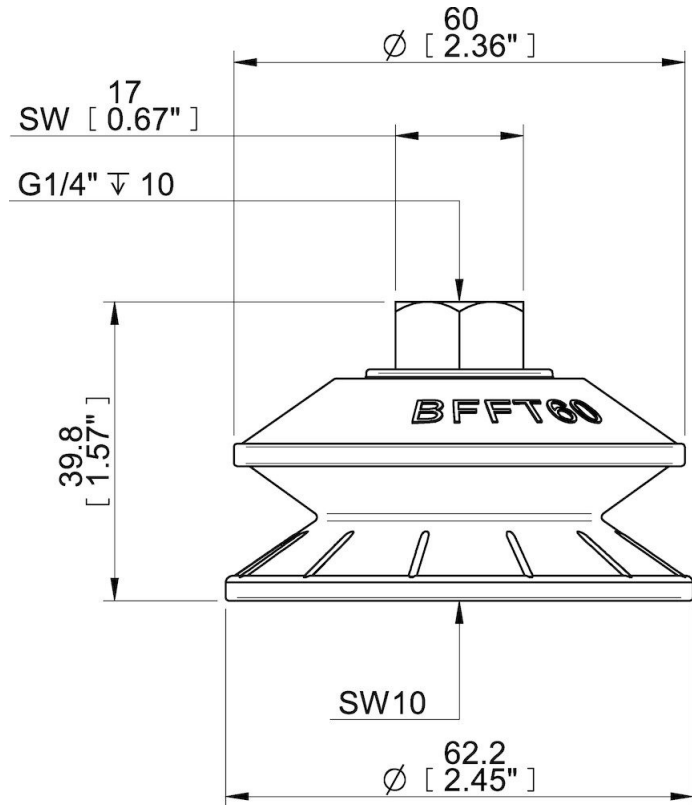

Values specified in this data sheet are tested at (unless otherwise stated):

- Room temperature (20°C [68°F] \pm 3°C [5.5°F]).
- Standard atmosphere (101.3 [29.9 inHg] \pm 1.0 kPa [0.3 inHg]).
- Relative humidity 20-70%.
- Compressed air quality, DIN ISO 8573-1 class 4.