

Vacuum switch VS4016, G1/8" male, 70 -kPa

Article number: 0110250



- Pre-set vacuum switch with digital output.
- Very low weight and small format, push-in or thread connections.
- PNP NO/NC or NPN NO/NC output functions.

Technical data

Description	Unit	Value
Material	-	CuZn (Au), PA, SS, Steel, Thermoplastic Polyurethane (TPE-U)
Temperature, max.	°C	85
Temperature, min.	°C	-25
Weight, min.	g	6
Display	-	LED indicator
Feed pressure, max. (@ vacuum connection)	MPa	0.2
Safety classification	-	IP40
Voltage	VDC	24 (12-30)
Valve function	-	NO, NC
Hysteresis	kPa	5-9
Signal range, max.	-kPa	75
Signal range, min.	-kPa	67
Height	mm	23.9
Length	mm	16.25
Width	mm	16.25
Voltage drop, max (100mA/24V inductive load)	VDC	0.055
Current, inductive, max.	A	0.1
Current, resistive, max.	A	0.4

Dimensional drawings

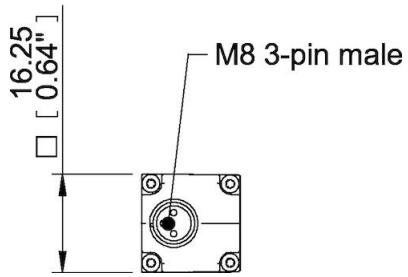
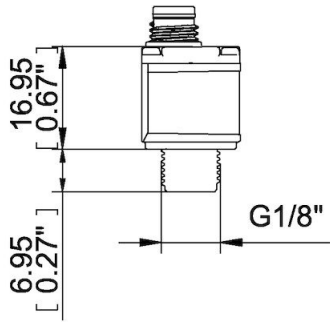
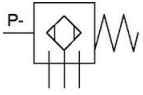

Accessories

0108141 | Cable M8 3-pin female L=2m