

# Fitting 75, G1/2" female, with cone valve

Article number: 0100556



- Suits suction cups: B75, B75P, B75-2, F75, F75P, FC100P
- With cone valve only for: F75

## Technical data

Description	Unit	Value
Material	-	Al, Nitrile (NBR), SS
Temperature, max.	°C	90
Temperature, min.	°C	-20
Weight, min.	g	75
Fitting size	-	1/2"
Fitting style	-	Female
Fitting type	-	G-thread

## Dimensional drawings

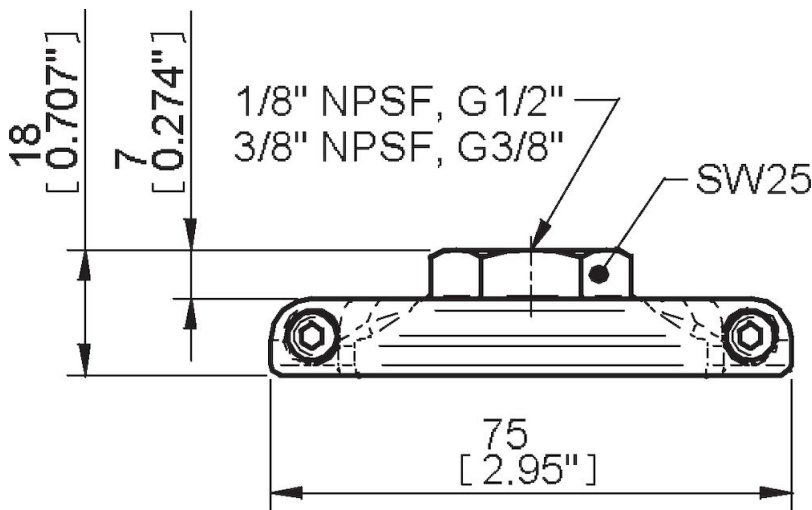

## Spare parts

0100729 | Cone Valve for Fitting 75