

Suction cup BFFT120P Polyurethane 60/60/30, G3/8" female with mesh filter

Article number: 0210580



- Special designed friction cups for thin (0.6-0.8 mm) oily metal sheets, such as outer body car parts in a press-to press forming process.
- Long lasting material, normal wear on friction cup will not affect the long term grip performance.
- Refined internal friction pattern provides additional grip performance, the suction cups can withstand high shear forces, typically 3–5 times more than corresponding conventional suction cups.
- Best choice if > 0.1g/m² press oil is used on the sheet but also a great choice for dry metal sheets.
- The "BFFT" design is suitable for thin flat or uneven/curved surfaces and if level compensation is needed, for example in de-stacking applications.
- The flat inner support, made of dual hardness, gives stability and good grip during movement in any orientation.
- DURAFLEX® suction cups manufactured in a specially developed material that features the elasticity of rubber and wear resistance of polyurethane. The material does not leave any marks on the objects handled and has a fantastic elastic memory, even after hundreds of thousands of cycles.

Technical data

Description	Unit	Value
Suction cup shape	-	Bellows
Application	-	Oily sheet metal
Suction cup design	-	Round
Characteristics	-	Oily sheet metal
Material	-	Polyurethane (PU)
Weight, min.	g	168.1
Suction cup model	-	BFFT
Volume	cm ³	165.6
Height	mm	61.1
Height 2 (Actuated)	mm	35
Outer diameter, min.	mm	120
Outer diameter, actuated	mm	124
Fitting size	-	3/8"
Fitting option	-	Filter mesh
Fitting style	-	Female
Fitting type	-	G-thread
Material	-	Al
Suction cup model	-	BFFT120 Dry metal sheet
Movement, vertical max.	mm	26
Curve radius, min.	mm	75
Suction cup model	-	BFFT120 Oily metal sheet
Movement, vertical max.	mm	26
Curve radius, min.	mm	75

Performance - Lifting forces

BFFT120 Dry metal sheet	Vertical (N)	Parallel (N)
60 -kPa	338	414
90 -kPa	346	585
BFFT120 Oily metal sheet		
60 -kPa	335	212
90 -kPa	340	291

Material

Name	Polyurethane (PU30)	Polyurethane (PU60)	Polyurethane (PU60)
Colour	Yellow	Green transparent	Orange
Temperature, min. °C	10	10	10
Temperature max. °C	50	50	50
Hardness °Shore A	30	60	60

Material resistance

Alcohol	n/a	n/a	n/a
Concentrated acids	Fair	Fair	Fair
Ethanol	Fair	Fair	Fair
Hydrolysis	Fair	Fair	Fair
Methanol	Poor	Poor	Poor
Oil	Excellent	Excellent	Excellent
Oxidation	Poor	Poor	Poor
Petrol	Fair	Fair	Fair
Wear resistance	Excellent	Excellent	Excellent
Weather and ozone	Excellent	Excellent	Excellent

Dimensional drawings

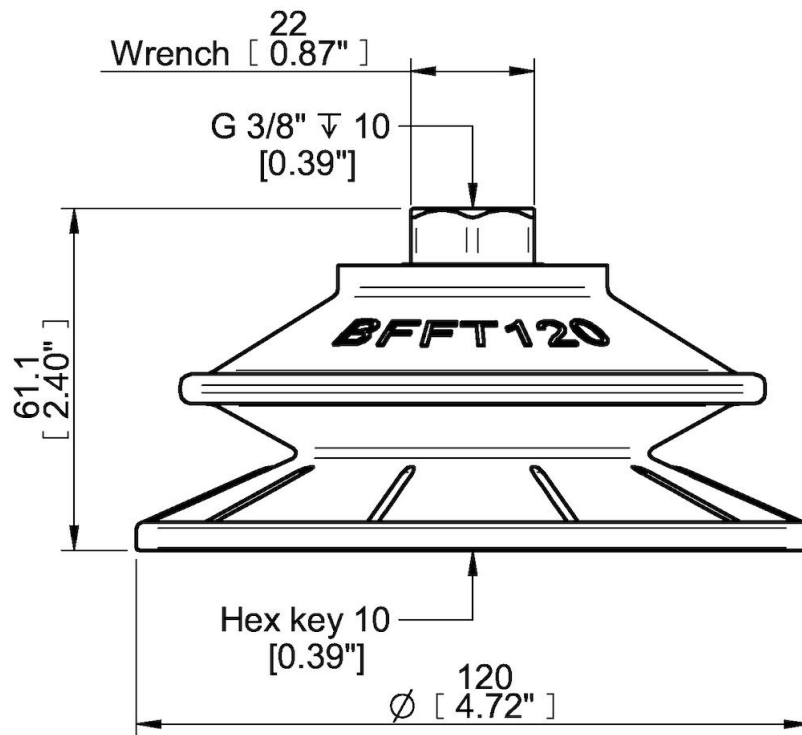

Values specified in this data sheet are tested at (unless otherwise stated):

- Room temperature (20°C [68°F] ± 3°C [5.5°F]).
- Standard atmosphere (101.3 [29.9 inHg] ± 1.0 kPa [0.3 inHg]).
- Relative humidity 20-70%.
- Compressed air quality, DIN ISO 8573-1 class 4.