



AXON LED High-intensity Elevated Lights

User Manual

UM-5078, Rev. 1.2.0, 2026-Jun-03

**ADB
SAFEGATE**

A.0 Disclaimer / Standard Warranty

CE certification

The equipment listed as CE certified means that the product complies with the essential requirements concerning safety and hygiene. The European directives that have been taken into consideration in the design are available on written request to ADB SAFEGATE.

ETL certification

The equipment listed as ETL certified means that the product complies with the essential requirements concerning safety and C22.2 No.180:13 (R2018) regulations. The CSA directives that have been taken into consideration in the design are available on written request to ADB SAFEGATE.

All Products Guarantee

ADB SAFEGATE will correct by repair or replacement per the applicable guarantee below, at its option, equipment or parts which fail because of mechanical, electrical or physical defects, provided that the goods have been properly handled and stored prior to installation, properly installed and properly operated after installation, and provided further that Buyer gives ADB SAFEGATE written notice of such defects after delivery of the goods to Buyer. Refer to the Safety section for more information on Material Handling Precautions and Storage precautions that must be followed.

ADB SAFEGATE reserves the right to examine goods upon which a claim is made. Said goods must be presented in the same condition as when the defect therein was discovered. ADB SAFEGATE further reserves the right to require the return of such goods to establish any claim.

ADB SAFEGATE's obligation under this guarantee is limited to making repair or replacement within a reasonable time after receipt of such written notice and does not include any other costs such as the cost of removal of defective part, installation of repaired product, labor or consequential damages of any kind, the exclusive remedy being to require such new parts to be furnished.

ADB SAFEGATE's liability under no circumstances will exceed the contract price of goods claimed to be defective. Any returns under this guarantee are to be on a transportation charges prepaid basis. For products not manufactured by, but sold by ADB SAFEGATE, warranty is limited to that extended by the original manufacturer. This is ADB SAFEGATE's sole guarantee and warranty with respect to the goods; there are no express warranties or warranties of fitness for any particular purpose or any implied warranties of fitness for any particular purpose or any implied warranties other than those made expressly herein. All such warranties being expressly disclaimed.

Standard Products Guarantee

Products manufactured by ADB SAFEGATE are guaranteed against mechanical, electrical, and physical defects (excluding lamps) which may occur during proper and normal use for a period of two years from the date of ex-works delivery, and are guaranteed to be merchantable and fit for the ordinary purposes for which such products are made.



Note

See your applicable sales agreement for a complete warranty description.

Replaced or repaired equipment under warranty falls into the warranty of the original delivery. No new warranty period is started for these replaced or repaired products.

FAA Certified products manufactured by ADB SAFEGATE

ADB SAFEGATE L858 Airfield Guidance Signs are warranted against mechanical and physical defects in design or manufacture for a period of 2 years from date of installation, per FAA AC 150/5345-44 (applicable edition).

ADB SAFEGATE LED products (with the exception of obstruction lighting) are warranted against electrical defects in design or manufacture of the LED or LED specific circuitry for a period of 4 years from date of installation, per FAA EB67 (applicable edition). These FAA certified constant current (series) powered LED products must be installed, interfaced and powered with and through products certified under the FAA Airfield Lighting Equipment Program (ALECP) to be included in this 4 (four) year warranty. This includes, but is not limited to, interface with products such as Base Cans, Isolation Transformers, Connectors, Wiring, and Constant Current Regulators.



Note

See your sales order contract for a complete warranty description.

Replaced or repaired equipment under warranty falls into the warranty of the original delivery. No new warranty period is started for these replaced or repaired products.

Liability



WARNING

Use of the equipment in ways other than described in the catalog leaflet and the manual may result in personal injury, death, or property and equipment damage. Use this equipment only as described in the manual.

ADB SAFEGATE cannot be held responsible for injuries or damages resulting from non-standard, unintended uses of its equipment. The equipment is designed and intended only for the purpose described in the manual. Uses not described in the manual are considered unintended uses and may result in serious personal injury, death or property damage.

Unintended uses, includes the following actions:

- Making changes to equipment that have not been recommended or described in this manual or using parts that are not genuine ADB SAFEGATE replacement parts or accessories.
- Failing to make sure that auxiliary equipment complies with approval agency requirements, local codes, and all applicable safety standards if not in contradiction with the general rules.
- Using materials or auxiliary equipment that are inappropriate or incompatible with your ADB SAFEGATE equipment.
- Allowing unskilled personnel to perform any task on or with the equipment.

Copyright Statement

This manual or parts thereof may not be reproduced, stored in a retrieval system, or transmitted, in any form or by any means, electronic, mechanical, photocopying, recording, nor otherwise, without the author's prior written consent.

This manual could contain technical inaccuracies or typographical errors. The author reserves the right to revise this manual from time to time in the contents thereof without obligation of the author to notify any person of such revision or change. Details and values given in this manual are average values and have been compiled with care. They are not binding, however, and the author disclaims any liability for damages or detriments suffered as a result of reliance on the information given herein or the use of products, processes or equipment to which this manual refers. No warranty is made that the use of the information or of the products, processes or equipment to which this manual refers will not infringe any third party's patents or rights. The information given does not release the buyer from making their own experiments and tests.

Table of Contents

1.0 Safety	1
1.1 Safety Messages.....	1
1.1.1 Introduction to Safety.....	2
1.1.2 Intended Use.....	2
1.1.3 Material Handling Precautions: Storage.....	3
1.1.4 Arc Flash and Electric Shock Hazard.....	3
1.1.5 Operation Safety.....	4
1.1.6 Maintenance Safety.....	4
1.1.7 Material Handling Precautions, ESD.....	5
2.0 About this Manual	7
2.1 How to Work with the Manual.....	7
2.2 Abbreviations and Terms.....	7
3.0 Introduction	9
3.1 Overview.....	10
3.2 Product Information.....	11
3.3 Dimensions and Weight.....	13
4.0 Installation	15
4.1 Unpacking the Unit.....	15
4.2 Required Tools.....	15
4.3 Installation Overview.....	15
4.4 Mounting Types & Options.....	16
4.5 Illuminated LEDs.....	17
4.6 Fixture Installation.....	19
5.0 Maintenance	29
5.1 Basic Maintenance Program.....	29
5.2 Workshop Maintenance - Spare Part Replacement.....	31
6.0 Ordering Codes	41
6.1 ICAO Approach Centerline and Siderow.....	41
6.2 ICAO Stop Bar.....	42
6.3 ICAO Runway Threshold, Threshold/End, End and Threshold Wingbar.....	43
6.4 Stopway.....	44
6.5 L-862S(L) FAA Stop Bar.....	45
6.6 L-862(L) Runway Edge.....	46
6.7 L-862E(L) FAA Runway Threshold, Threshold/End and End.....	47
7.0 Spare Parts	49
7.1 AXON Elevated.....	49
7.2 Optical Module.....	52
7.3 Power Supply Board.....	59
7.4 Tools and Accessories.....	61
A.0 Power Tables	63
B.0 Alignment Guidance	67
C.0 Cable Loss	73
D.0 Support	75
D.1 ADB SAFEGATE Website.....	76
E.0 Recycling	77
E.1 Local Authority Recycling.....	77
E.2 ADB SAFEGATE Recycling.....	77

List of Figures

Figure 1: Figure 1	26
Figure 2: Figure 2	26
Figure 3: Figure 3	26
Figure 4: Figure 4	27

1.0 Safety

Introduction to Safety







This section contains general safety instructions for installing and using ADB SAFEGATE equipment. Some safety instructions may not apply to the equipment in this manual. Task- and equipment-specific warnings are included in other sections of this manual where appropriate.

1.1 Safety Messages

HAZARD Icons used in this manual

For all HAZARD symbols in use, see the Safety section. All symbols must comply with ISO and ANSI standards.

Carefully read and observe all safety instructions in this manual, which alert you to safety hazards and conditions that may result in personal injury, death or property and equipment damage and are accompanied by the symbols shown below.

	<p>WARNING</p> <p>Failure to observe a warning may result in personal injury, death or equipment damage.</p>
	<p>DANGER – Risk of electrical shock or ARC FLASH</p> <p>Disconnect equipment from line voltage. Failure to observe this warning may result in personal injury, death, or equipment damage. ARC Flash may cause blindness, severe burns or death.</p>
	<p>WARNING – Wear personal protective equipment</p> <p>Failure to observe may result in serious injury.</p>
	<p>WARNING – Do not touch</p> <p>Failure to observe this warning may result in personal injury, death, or equipment damage.</p>
	<p>CAUTION</p> <p>Failure to observe a caution may result in equipment damage.</p>
	<p>ELECTROSTATIC SENSITIVE DEVICES</p> <p>This equipment may contain electrostatic devices.</p>

Qualified Personnel

	<p>Important Information</p> <p>The term qualified personnel is defined here as individuals who thoroughly understand the equipment and its safe operation, maintenance and repair. Qualified personnel are physically capable of performing the required tasks, familiar with all relevant safety rules and regulations and have been trained to safely install, operate, maintain and repair the equipment. It is the responsibility of the company operating this equipment to ensure that its personnel meet these requirements.</p> <p>Always use required personal protective equipment (PPE) and follow safe electrical work practice.</p>
---	---

1.1.1 Introduction to Safety



CAUTION

Unsafe Equipment Use

This equipment may contain electrostatic devices, hazardous voltages and sharp edges on components

- Read installation instructions in their entirety before starting installation.
- Become familiar with the general safety instructions in this section of the manual before installing, operating, maintaining or repairing this equipment.
- Read and carefully follow the instructions throughout this manual for performing specific tasks and working with specific equipment.
- Make this manual available to personnel installing, operating, maintaining or repairing this equipment.
- Follow all applicable safety procedures required by your company, industry standards and government or other regulatory agencies.
- Install all electrical connections to local code.
- Use only electrical wire of sufficient gauge and insulation to handle the rated current demand. All wiring must meet local codes.
- Route electrical wiring along a protected path. Make sure they will not be damaged by moving equipment.
- Protect components from damage, wear, and harsh environment conditions.
- Allow ample room for maintenance, panel accessibility, and cover removal.
- Protect equipment with safety devices as specified by applicable safety regulations
- If safety devices must be removed for installation, install them immediately after the work is completed and check them for proper functioning prior to returning power to the circuit.

Failure to follow these instructions can result in serious injury, death or equipment damage

Additional Reference Materials



Important Information

- IEC – International Standards and Conformity Assessment for all electrical, electronic and related technologies.
- IEC 60364 – Electrical Installations in Buildings.
- CSA – C22.2 No.180:13 (R2018), series isolating transformers for airport lighting.
- FAA Advisory: AC 150/5340-26 (current edition), Maintenance of Airport Visual Aid Facilities.
- Maintenance personnel must refer to the maintenance procedure described in the ICAO Airport Services Manual, Part 9.
- ANSI/NFPA 79, Electrical Standards for Metalworking Machine Tools.
- National and local electrical codes and standards.

1.1.2 Intended Use



CAUTION

Use this equipment as intended by the manufacturer.

This equipment is designed to perform a specific function. Do not use this equipment for other purposes.

Failure to follow this instruction can result in serious injury, death or equipment damage.

1.1.3 Material Handling Precautions: Storage



CAUTION

Improper Storage

Store this equipment properly

- If equipment is to be stored prior to installation, it must be protected from the weather elements and kept free of condensation and dust.

Failure to follow this instruction can result in equipment damage

1.1.4 Arc Flash and Electric Shock Hazard



DANGER

SERIES CIRCUITS HAVE HAZARDOUS VOLTAGES

THIS EQUIPMENT PRODUCES HIGH VOLTAGES TO MAINTAIN THE SPECIFIED CURRENT - DO NOT DISCONNECT WHILE ENERGIZED.

- ALLOW ONLY QUALIFIED PERSONNEL TO PERFORM MAINTENANCE, TROUBLESHOOTING, AND REPAIR TASKS.
- ONLY PERSONS WHO ARE PROPERLY TRAINED AND FAMILIAR WITH ADB SAFEGATE EQUIPMENT ARE PERMITTED TO SERVICE THIS EQUIPMENT.
- AN OPEN AIRFIELD CURRENT CIRCUIT IS CAPABLE OF GENERATING >5000 VAC AND MAY APPEAR OFF TO A METER.
- NEVER UNPLUG A DEVICE FROM A CONSTANT CURRENT CIRCUIT WHILE IT IS OPERATING; ARC FLASH MAY RESULT.
- DISCONNECT AND LOCK OUT ELECTRICAL POWER.
- ALWAYS USE SAFETY DEVICES WHEN WORKING ON THIS EQUIPMENT.
- FOLLOW THE RECOMMENDED MAINTENANCE PROCEDURES IN THE PRODUCT MANUALS.
- DO NOT SERVICE OR ADJUST ANY EQUIPMENT UNLESS ANOTHER PERSON TRAINED IN FIRST AID AND CPR IS PRESENT.
- CONNECT ALL DISCONNECTED EQUIPMENT GROUND CABLES AND WIRES AFTER SERVICING EQUIPMENT. GROUND ALL CONDUCTIVE EQUIPMENT.
- USE ONLY APPROVED ADB SAFEGATE REPLACEMENT PARTS. USING UNAPPROVED PARTS OR MAKING UNAPPROVED MODIFICATIONS TO EQUIPMENT MAY VOID AGENCY APPROVALS AND CREATE SAFETY HAZARDS.
- CHECK THE INTERLOCK SYSTEMS PERIODICALLY TO ENSURE THEIR EFFECTIVENESS.
- DO NOT ATTEMPT TO SERVICE ELECTRICAL EQUIPMENT IF STANDING WATER IS PRESENT. USE CAUTION WHEN SERVICING ELECTRICAL EQUIPMENT IN A HIGH-HUMIDITY ENVIRONMENT.
- USE TOOLS WITH INSULATED HANDLES WHEN WORKING WITH AIRFIELD ELECTRICAL EQUIPMENT.

FAILURE TO FOLLOW THESE INSTRUCTIONS CAN RESULT IN DEATH OR EQUIPMENT DAMAGE

1.1.5 Operation Safety



CAUTION

Improper Operation

Do Not Operate this equipment other than as specified by the manufacturer

- Only qualified personnel, physically capable of operating the equipment and with no impairments in their judgment or reaction times, should operate this equipment.
- Read all system component manuals before operating this equipment. A thorough understanding of system components and their operation will help you operate the system safely and efficiently.
- Before starting this equipment, check all safety interlocks, fire-detection systems, and protective devices such as panels and covers. Make sure all devices are fully functional. Do not operate the system if these devices are not working properly. Do not deactivate or bypass automatic safety interlocks or locked-out electrical disconnects or pneumatic valves.
- Protect equipment with safety devices as specified by applicable safety regulations.
- If safety devices must be removed for installation, install them immediately after the work is completed and check them for proper functioning.
- Route electrical wiring along a protected path. Make sure they will not be damaged by moving equipment.
- Never operate equipment with a known malfunction.
- Do not attempt to operate or service electrical equipment if standing water is present.
- Use this equipment only in the environments for which it is rated. Do not operate this equipment in humid, flammable, or explosive environments unless it has been rated for safe operation in these environments.
- Never touch exposed electrical connections on equipment while the power is ON.

Failure to follow these instructions can result in serious injury, death or equipment damage.

1.1.6 Maintenance Safety



DANGER

ELECTRIC SHOCK HAZARD

THIS EQUIPMENT MAY CONTAIN ELECTROSTATIC DEVICES

- DO NOT OPERATE A SYSTEM THAT CONTAINS MALFUNCTIONING COMPONENTS. IF A COMPONENT MALFUNCTIONS, TURN THE SYSTEM OFF IMMEDIATELY.
- DISCONNECT AND LOCK OUT ELECTRICAL POWER.
- ALLOW ONLY QUALIFIED PERSONNEL TO MAKE REPAIRS OR REPLACE MALFUNCTIONING COMPONENTS ACCORDING TO INSTRUCTIONS PROVIDED IN MANUAL.

FAILURE TO FOLLOW THESE INSTRUCTIONS CAN RESULT IN DEATH OR EQUIPMENT DAMAGE

1.1.7 Material Handling Precautions, ESD



CAUTION

Electrostatic Sensitive Devices

This equipment may contain electrostatic devices

- Protect from electrostatic discharge.
- Electronic modules and components should be touched only when this is unavoidable e.g. soldering, replacement.
- Before touching any component of the cabinet you shall bring your body to the same potential as the cabinet by touching a conductive earthed part of the cabinet.
- Electronic modules or components must not be brought in contact with highly insulating materials such as plastic sheets, synthetic fiber clothing. They must be laid down on conductive surfaces.
- The tip of the soldering iron must be grounded.
- Electronic modules and components must be stored and transported in conductive packing.

Failure to follow this instruction can result in equipment damage

2.0 About this Manual

This document includes Axon I elevated light fixture information with a focus on safety, installation and maintenance procedures.

For more information, see www.adbsafegate.com.



Note

It is very important to read this document before any work is started.

This manual covers the following elevated fixtures:

- Approach Centerline
- Approach Crossbar
- Approach Side Row
- Runway Threshold (L862E-L)
- ICAO & FAA L862E-(L) - Runway Threshold/End
- Runway Threshold Wingbar
- ICAO & FAA L862E-(L) - Runway End
- ICAO & FAA L862-(L) - Runway Edge
- Runway Stopway
- ICAO & FAA L862S-(L) - Stopbar

2.1 How to Work with the Manual

1. Familiarize yourself with the structure and content.
2. Carry out the actions completely and in the given sequence.

2.2 Abbreviations and Terms

Abbreviations and Terms	Description
CAA	Civil Aviation Authority
CCR	Constant Current Regulator
FAA	Federal Aviation Administration
FOD	Foreign Object Debris
ICAO	International Civil Aviation Organization
IEC	International Electrical Committee
ILCMS	Individual Light Control and Monitoring System
ICAO	International Civil Aviation Organization
LED	Light Emitting Diode
NATO	North Atlantic Treaty Organisation
STAC	Service Technique de l'Aviation Civile (France)
STANAG	Standardization Agreement (NATO)

3.0 Introduction

The all-in-one solution

The Axon high intensity elevated light fixture, is a modular LED light fixture, available in multiple applications, and a range of functional options:

Power Converter Options

Non-MON — Basic Operation, providing power only.

MON — A LED light fixture with integrated fail open technology for CCR or ILCMs monitoring capability

Functional Options

Low Intensity Approach — Integrated omnidirectional, low intensity approach light

Circling Guidance — Integrated omnidirectional circling guidance, which dims in proportion to intensity step

Constant Circling Guidance — Integrated omnidirectional circling guidance, which remains at 100% intensity, irrespective of input current.

Near Infra Red (NIR) — Near Infra Red LED to support EFVS or NVG operations, both Overt and Covert.

SMART Arctic Kit — Arctic kit module, that retains full heating power, even at lower intensity steps.

Advanced Connectivity — For EQ only the ability to add future advanced connectivity modules, such as cellular monitoring.

3.1 Overview



Note

Refer to Spare Parts chapter for a complete overview of the fixture in all available versions.



3.2 Product Information

Compliance with Standards (Current Versions)

Compliance with Standards (current Versions)	
FAA	L862(L), L862E(L), L862S(L) AC 150/5345-46 and the FAA Engineering Brief No. 67
ICAO	Annex 14 Volume I and ADM part
EASA	CS-ADR-DSN
Australia	MOS 139
Canada	TP 312
IEC	61827
NATO	STANAG 3316
STAC	SPE/STAC/SE/E/VIS/6008
UK	CAP 168
IP	IP68 & IP69K
CE	

Uses

ADE AC

ICAO & Regional

- Approach Centerline and Crossbar

ADE AS

ICAO & Regional

- Approach Centerline and Crossbar

ADE RT

ICAO & Regional

- Runway Threshold / Threshold End

FAA

- L-862E(L) Runway Threshold / Threshold End

ADE RN

ICAO & Regional

- Runway End

FAA

- L-862E(L) Runway End

ADE RW

ICAO & Regional

- Runway Threshold Wingbar

ADE RE

ICAO & Regional

- Runway Edge

FAA

- L-862(L) Runway Edge

ADE SW

ICAO & Regional

- Runway Stopway

ADE SB

ICAO & Regional

- Stopbar

FAA

- L-862S(L) Stopbar

Features and Benefits

Efficiency

- Infra Red for EFVS / NVG compatibility. Highly configurable to suit operational requirement
- LED is PWM-modulated at 400 Hz to optimize performance and eliminate human flicker perception, regardless of brightness levels
- Lights are fully dimmable and conform to FAA EB 67D and ICAO Annex 14 dimming curve
- Dedicated aiming device allows easy leveling and azimuth aiming of the light
- Three screws allow for 4° leveling adjustment of the fixture after installation or central barrel screw with two opposing locking screws ensure easy and stable leveling.
- AXON EQ features ILCMS remote and onboard environmental sensors for the LINC 360 system, enabling high data capacity and radio degradation resistance. This results in top-notch communication platform for control, status, and health/usage monitoring
- AXON EQ can be upgraded with plug-in modules and configured via LINC 360 or CORTEX CLOUD for additional features
- AXON EQ version available with optional Cellular monitoring module

Sustainability

- Independent Product Carbon Footprint calculation to support in product lifecycle analysis
- Modular housing maximizes parts commonality and enables midlife upgrades for enhanced functionality instead of requiring a new product when quartz-incandescent fixtures are replaced with LED fixtures, airport staff can add more lights without increasing CCR size.
- A single fixture family covers all elevated approach, runway and stop bar applications
- IP68 & IP69K rated enclosure designed for harsh environments; all fastenings are stainless steel IP67 design prevents water, dust and insect entry.
- This product is a direct replacement for ADB Safegate LED elevated fixtures, thanks to its mechanical and photometric backwards compatibility
- Finishing: Stainless steel hardware, aluminum body, phosphated aviation yellow electrostatic polyester powder coating
- Based on the LED manufacturer's ratings & calculations, we guarantee a LED life expectancy L70 higher than 50,000 operation hours
- Aerodynamic and lightweight weight designed to withstand heaviest jet blast

Safety

- Identifiable daytime recognition, with large surface area colored optical module surround
- Modular mechanical design consolidates and strengthens product components for faster, easier maintenance and reconfiguration
- SMART Arctic kit with option of heater output down to 4.1A
- Failed-LED Detection as required by Engineering Brief 67D
- The product meets the lightning protection criteria of ANSI/ IEEE C62.41-1991 and FAA Eng. Brief 67's Location Category C2 requirements, which outlines a 1.2/50 - 8/20 μ s combination wave, peaking at 10,000 V and 5,000 A

Power Supply

Lights have been designed to work with any IEC- or FAA-compliant transformer up to 150 W. See the manual for calculation of actual circuit VA loads.



Note

Refer to the appendix of user manual for the Axon elevated lights for a complete power table and the cable loss formula.

Maintenance and Installation

The light fixture can be ground mounted or mast mounted (dependent on application), utilizing a range of recommended mounting accessories.

It is designed to be a retrofit into existing installations that utilize ADB Safegate LEAP and EREL fixtures, to allow smooth transition to this generation of fixture.

Operating Conditions

Operating temperature	-55 °C to +55 °C / -67 °F to +131 °F
Storage temperature	-60 °C to +80 °C / -76 °F to +176 °F
Humidity	Up to 100%

3.3 Dimensions and Weight

The weight and measurement depends on version of the light fixture.

Version	Weight	Dimension
AC / AS / SF / RW / SB	2.6kg	
RT / RN / SW	2.6kg	
SB / SC	2.6kg	

4.0 Installation

This section describes how to install the complete fixture.



Note

Refer to the Maintenance chapter for information on how to replace parts of the fixture.

4.1 Unpacking the Unit

To reduce the risk of damaging the light assembly, unpack the Axon light fixtures at the installation site. If damage to any equipment is noted, file a claim form with the carrier immediately.



WARNING

Do not damage the cable insulation.

To reduce the possibility of damaging the light assembly, unpack the light fixtures at the installation site. If damage to any equipment is noted, file a claim form with the carrier immediately. When receiving the light fixture, open the box and verify that the characteristics of the light fixture correspond to the design requirements, such as type, color etc.

When installing a light fixture where the control and monitoring function is to be activated at a later stage, make sure to register product information, such as PID/SN and position of the light fixture in, for example, a site documentation table. The information is required for remote activation and administration of control and monitoring functionality from a substation.

4.2 Required Tools

The following tools are recommended for installation:

- Torque wrench with 13mm socket
- Allen wrench
- Open or adjustable spanner 52 - 62mm
- Standard alignment tool, if applicable
- Electronic alignment tool, if applicable

Tip

You can use the standard alignment tool for ground mounted fixtures up to a height of 2 m. Use electronic alignment tool for fixtures on high masts, when it is not possible to reach the top of the mast in it upright position. Typically, the electronic alignment tool is used for fixtures on tiltable masts.

4.3 Installation Overview



DANGER

ONLY INSTALL THE FIXTURE ON MOUNTING SUPPORTS:

- THAT ADB SAFEGATE HAS APPROVED
- THAT ARE INSTALLED ACCORDING TO THE INSTRUCTION MANUAL OF THE MOUNTING SUPPORT
- FAILURE TO DO SO CAN RESULT IN A HIGHLY DANGEROUS SITUATION OF FOD, WITH POTENTIALLY LETHAL CONSEQUENCES
- DO NOT DAMAGE THE CABLE INSULATION
- MAKE SURE THE POWER TO THE SERIES CIRCUIT IS OFF WHEN YOU INSTALL OR REMOVE ANY FIXTURE. MAKE SURE THAT THE INSTALLATION, ALIGNMENT AND THE POSITION OF THE FIXTURE COMPLIES WITH FAA ADVISORY CIRCULAR AC 150/5340-30 (LATEST REVISION) AND ICAO ANNEX 14, VOLUME I, PARA 5.3.9 FOR RUNWAY EDGE LIGHTS.



WARNING

- Use protective gloves and face protection.
 - The female threads for the fixation and adjustment screws are treated with a corrosion inhibitor. This product, when in contact with your the eyes or your skin, can cause serious irritations. It can be harmful to inhale or ingest this product!
 - If your eyes or skin come into contact with this product, rinse abundantly. If you inhale or ingest this product, contact a physician immediately.
-



Note

Make sure that:

- The fixture is powered from a 6.6 A series circuit.
 - The series circuit is powered by a Constant Current Regulator that complies with IEC 61820-3-2, IEC 61822 or FAA AC 5345-10 (latest revision).
 - The transformer is series isolation transformer that complies with IEC 61823 or FAA AC 5345-47 (latest revision); the power of the series transformer shall not exceed 150 W.
 - The mounting support is correctly earthed. Failure to do so will void the warranty for all damages that occur as a result of voltage surges.
-

4.4 Mounting Types & Options

Column Mount



Use – To fit ADB Safegate 1" column and frangible couplings.

Applications – Runway Edge, Stopway, Threshold, Threshold/End & Runway End

Adjustment – +/- 4° of vertical & 360° horizontal alignment, via 3 screw 'tripod' adjustment and locking nuts.

Overall Height Options:-

- ICAO, <350mm, 14", 20", 24" & 30"
- FAA, 14", 20", 24" & 30"

Coupling Thread Options:

- ICAO, 2" 11 TPI (BSP), 2" 11.5 TPI (NPS)
- FAA, 2" 11.5 TPI (NPS) & 1.5" x 12TPI

60mm Mount



Use – Fit 60mm ADB Safegate frangible couplings, poles or masts.

Applications – Approach, Approach Side Row, Threshold Wingbar & Stopbar

Adjustment – -5° to + 30° of vertical & 360° horizontal alignment, via 'central barrel screw' and locking screw and nuts.

Overall Height Options:-

- ICAO, <350mm, 14", 20", 24" & 30"
- FAA, 14", 20", 24" & 30"

Coupling Thread Options:

- ICAO, 2" 11 TPI (BSP), 2" 11.5 TPI (NPS)
- FAA, 2" 11.5 TPI (NPS)

4.5 Illuminated LEDs

The Axon Elevated Light features a modular design, allowing us to reuse optical blocks and LED PCBs across different applications. As a result, not all LED positions are illuminated in every configuration. This is intentional and designed to optimize photometric performance and power consumption for each specific application.

If you notice certain LEDs are not lit, this is not necessarily a fault. Refer to the overview below, which details the specific LEDs that are illuminated for each application. This will help ensure correct visual inspection and avoid misinterpretation.



Approach Centreline & Crossbar

- 12 White LEDs
- Top center LED is only illuminated if combined low intensity omni directional is selected.
- Bottom center LED is for Infra Red enabled applications only and is non visible



Approach Side Row

- 12 Red LEDs
- Top center LED is only illuminated if combined low intensity omni directional is selected.
- Bottom center LED is for Infra Red enabled applications only and is non visible



ICAO Threshold

- 6 Green LEDs
- Bottom center LED is for Infra Red enabled applications only and is non visible



FAA Threshold L862 E - L

- 4 Green LEDs
- Bottom center LED is for Infra Red enabled applications only and is non visible



ICAO Runway End

- 6 Red LEDs
- Bottom center LED is for Infra Red enabled applications only and is non visible



FAA Runway End L862 E - L

- 6 Red LEDs
- Bottom center LED is for Infra Red enabled applications only and is non visible



ICAO Threshold Wingbar

- 12 Green LEDs
- Bottom center LED is for Infra Red enabled applications only and is non visible



Runway Edge White L862 - L

- 6 White LEDs
- Top center LED is only illuminated if circling guidance is enabled (always for L862 – L).
- Bottom center LED is for Infra Red enabled applications only and is non visible



Runway Edge Yellow L862 - L

- 6 Yellow LEDs
- Top center LED is only illuminated if circling guidance is enabled (always for L862 – L).
- Bottom center LED is for Infra Red enabled applications only and is non visible



Runway Edge Red L862 – L & ICAO Stopway

- 6 Red LEDs
- Top center LED is only illuminated if circling guidance is enabled (always for L862 – L).
- Bottom center LED is for Infra Red enabled applications only and is non visible



FAA Displaced Threshold L862 E

- 4 Green LEDs
- Bottom center LED is for Infra Red enabled applications only and is non visible



ICAO Stopway

- 6 Red LEDs
- Bottom center LED is for Infra Red enabled applications only and is non visible



ICAO Stopbar

- 6 Red LEDs
- Bottom center LED is for Infra Red enabled applications only and is non visible



FAA Stopbar L862 S - L

- 12 Red LEDs
- Bottom center LED is for Infra Red enabled applications only and is non visible

4.6 Fixture Installation

Column Mount

1. Connect the plug (A) to the receptacle of the transformer.
2. Connect the supplied ground wire to the lower body with screw and washer and tighten to 2.5 Nm (22 in-lbs). Crimp the ground wire (B) to the circuit ground.
3. Loosen the screws (C).
4. Place the fixture on the base plate.
5. Turn the frangible coupling (D) into the receptacle of the base plate.

i Note Do not turn the fixture. This prevents the cable from twisting.

6. Tighten the coupling (D) into the base plate.
Use an open or adjustable spanner that fits the hexagon of the frangible coupling.
7. Make sure the arrow (E) on the top of the light points to the center line of the runway (with the exception of approach centerline, runway end or straight threshold, where it is ignored)
8. Proceed to Alignment.

60mm Mount

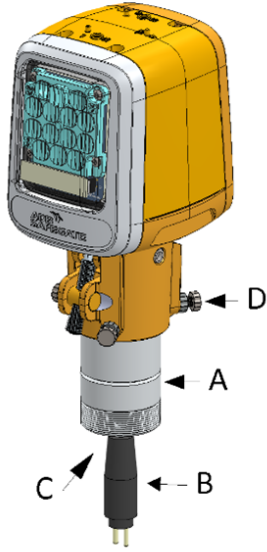

1. If using a frangible coupling, turn the frangible coupling (A) into the receptacle of the base plate and pass the transformer secondary cable through the center. If mounting on a pole or mast, proceed to next step.
2. Connect the plug to the receptacle of the transformer (B)

Note
Do not turn the fixture. This prevents the cable from twisting.

3. Connect the supplied ground wire to the lower body with screw and washer and tighten to 2.5 Nm (22 in-lbs). Crimp the ground wire (C) to the circuit ground.
4. Loosen the screws (D)
5. Place the fixture onto the coupling, pole or mast.
6. Proceed to Alignment.

Alignment Tool Overview

Full details of the tool can be found in the Light Alignment Device Operation Manual

It consists of 3 main parts:

Mount Device – This is the mounting interface between the tool and the light fixture. Such modularity allows this alignment tool to be used with different fixture, via alternative mounting interfaces and avoids the need for fixture specific tools.

Gimbal Device – This is secured to the mount device and is equipped with an elevation and vernier toe-in scale, for setting the correct alignment angles. It is further equipped with a standard NATO rail interface, to allow the mounting of 'off the shelf' tools, such as magnifying or laser sights, to aid in light fixture alignment.

Open Sight Device – This is the standard open sighting device, which allows for precise visual sighting towards a reference mark. It is further equipped with leveling bubbles to ensure correct elevation adjustment.

Optional Self Calibration Tools – These allow for rapid self verification of the alignment tool.

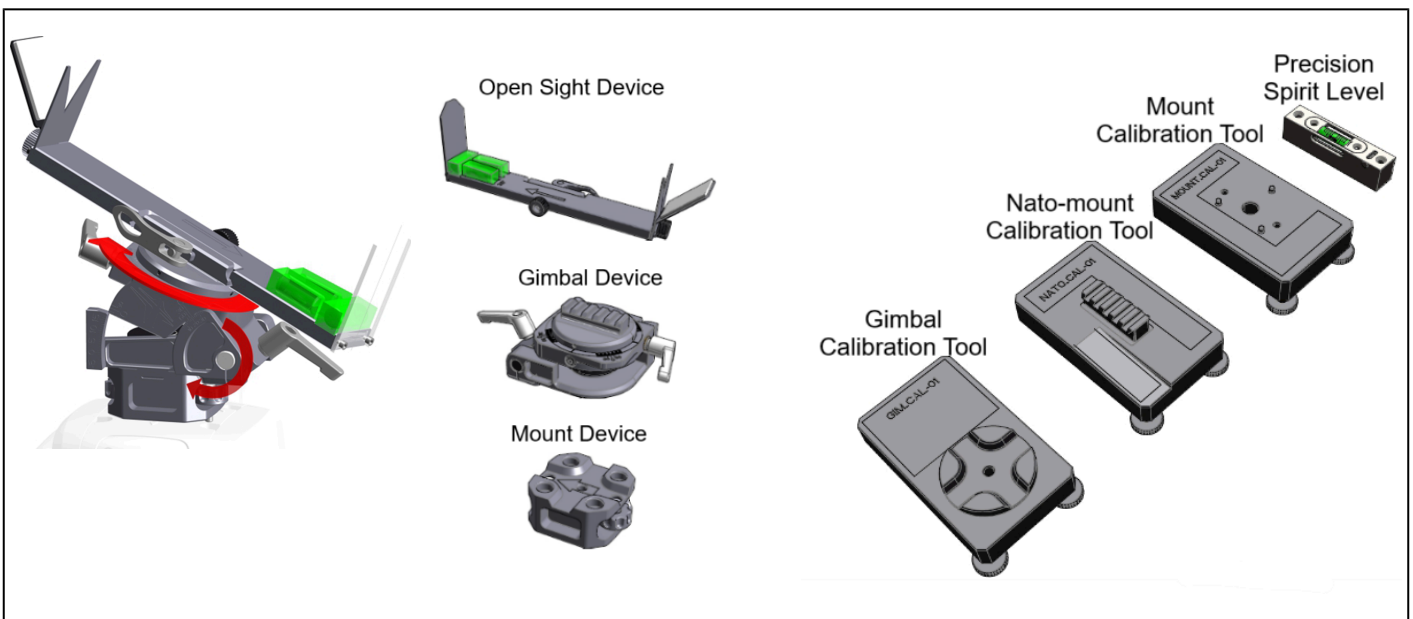

Alignment Guidelines & Principle

This fixture is aligned in azimuth (toe-in) by looking at a reference mark through the open sight device of the alignment tool, and used in conjunction with the toe-in vernier scale. Elevation is adjusted in conjunction with the elevation vernier scale and bubble levels A & B.

Depending on the position of the fixture, the reference mark may be another light in the same row or a stick installed for this purpose. Usually, for runway edge lights, another light of the same row is used. For threshold and runway end lights, a stick can be installed parallel to the runway center line at equal distance to the light or sighted perpendicular to the runway.

In some instances there is a built in elevation to the optical module of 3.5°. It is therefore important to reference the correct bubble level (A or B), to compensate for this where required. Full details can be found in Appendix C of this user manual.



Note

The alignment tool can be installed in two directions. The device should be positioned so that that arrow on the gimbal device is pointing towards the intended direction of sighting reference.

For a detailed overview of the alignment and calibration tools, please see light alignment device operation manual.

Refer to the Appendix C of user manual for the Axon elevated lights for complete application guidance with regard to reference sighting and angle setting of the tool.

Install the Alignment Tool on the Fixture

<p>Thumb Screws</p>	<p>1</p> <p>Install the mount device onto the threaded holes on the top of the light fixture, and secure with the two thumb screws. The arrow should be pointing in the intended direction of alignment sighting.</p> <p>It will be necessary to remove and replace the two torx screws in the top of the fixture to prevent debris build up in the mounting holes. Torque to 2.5Nm (22 in-lbs)</p>
<p>Thumb Screw</p>	<p>2</p> <p>Install the Gimbal device onto the mount device and secure using the thumb screw. Note this can be mounting for parallel or perpendicular sighting.</p>
<p>NATO Rail</p> <p>Lever Clamp</p> <p>Thumb Screw</p>	<p>3</p> <p>Secure the open sight to the NATO rail of the Gimbal device. Use the thumb screw to position the locking block and level clamp close enough for the level to lock open sign. Close lever clamp to secure open sight. The locking block is keyed to keep the level handle in line with the open sight device.</p> <p>4</p> <p>Once assembled, it is not necessary to disassembly when transferring between lights. The two thumb screws of the mount device can be undone and the whole assembly carefully transferred to the next fixture.</p>

Light Fixture Leveling & Alignment

Reading the Vernier Scales

The gimball device consists of two principle alignments for correct adjustment of elevation (vertical angle) and azimuth (toe-in). In both cases a vernier scale is used, and it's important to understand and read the scales correctly:

Elevation Scale

The elevation consists of two vernier scales. The main scale allows for adjustment from -5° to $+17^{\circ}$, this is suitable for most installations. The secondary scale is for adjustments between $+8^{\circ}$ to 32°

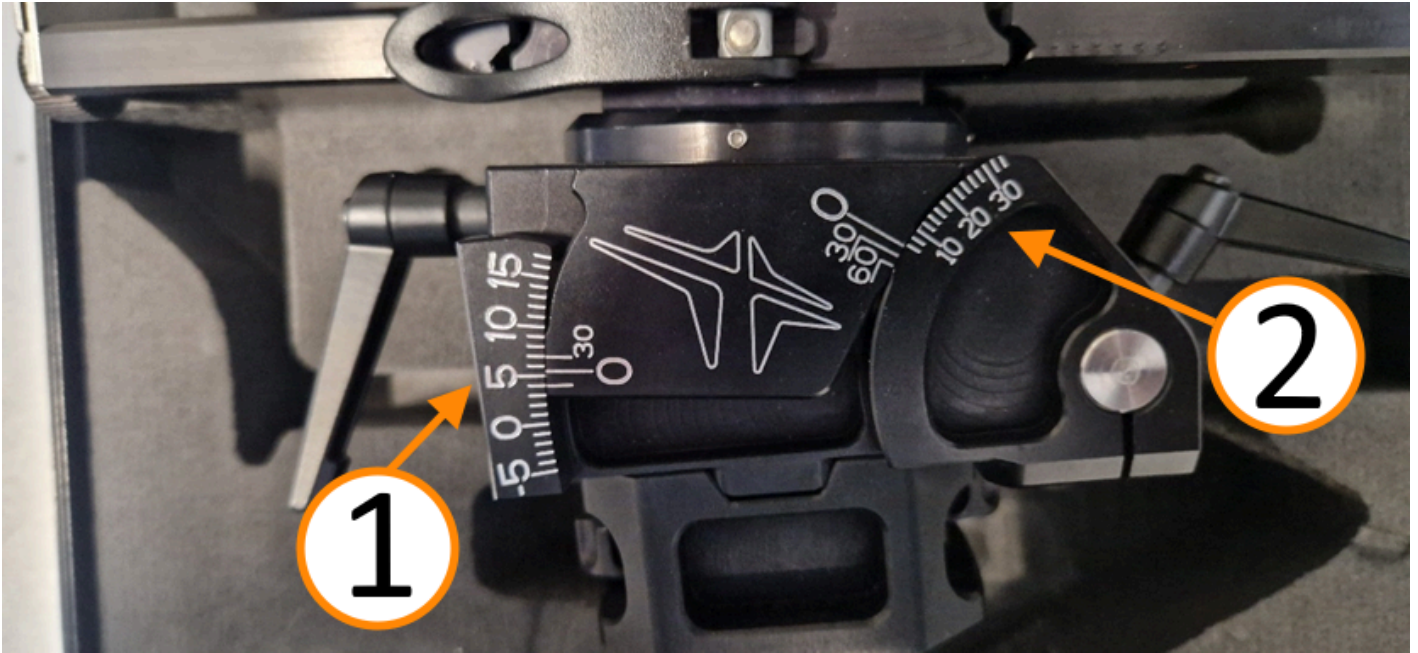

1. Main Scale
2. Secondary Scale

Main Scale

The main scale is in increments of 1°, the vernier scale has two increments in minutes of arc – marked at 0' and 30'. 0' is set for the angle as a whole number, 30' of arc, is equivalent to 0.5° and for 0.5° adjustment.

Therefore when the vernier scale 0' is perfectly aligned to a main scale increments of 1°, the adjustment is set at that exact degree, To set at increments of 0.5°, the vernier scale 30' must align to the next increment after the desired full degree.

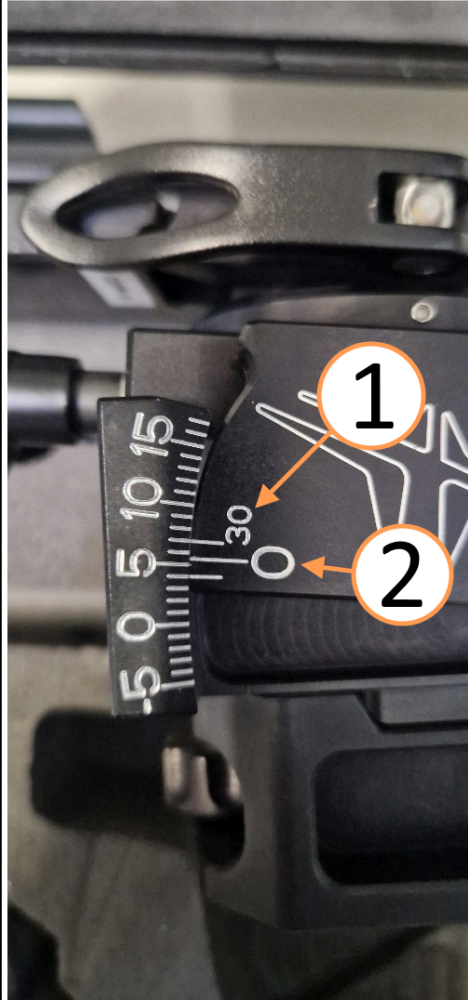

In this example the elevation alignment is set at 5.5° or 5° and 30' of arc:

1. The next possible alignment of the 30' of arc is made, without exceeding 6°. This achieves the additional 0.5° to give a total of 5.5°
2. 0 is greater than 5°, but less than 6°

Secondary Scale

The secondary scale uses the same principle, however the main increments are 2° and the vernier scale has three increments in minutes of arc – marked at 0', 30' and 60'. 0' is set for the angle as a whole number according to the scale. 60' is equivalent to 1° and is for the whole angle between increments of the main scale. 30' of arc, is equivalent to 0.5° and for 0.5° adjustment. Therefore when the vernier scale 0' is perfectly aligned to a main scale increments of 2° , the adjustment is set at that exact degree, To set at increments of 1° , between the main scale increments, the 60' must align to the next increment after the desired 2° increment. To set at increments of 0.5° , the vernier scale 30' must align to the next increment after the desired full degree.

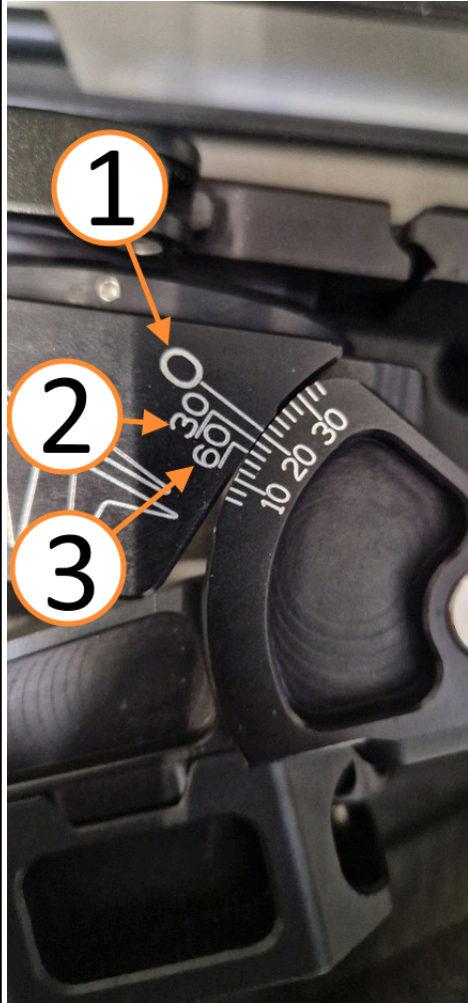

In this example the elevation alignment is set at 20.5° :

1. 0 is greater than 20° , but less than 22°
2. The next possible alignment of the 30' of arc is made, without exceeding 22° . This achieves the additional 0.5° to give a total of 20.5°
3. Note that the 60' is has not aligned to anything.

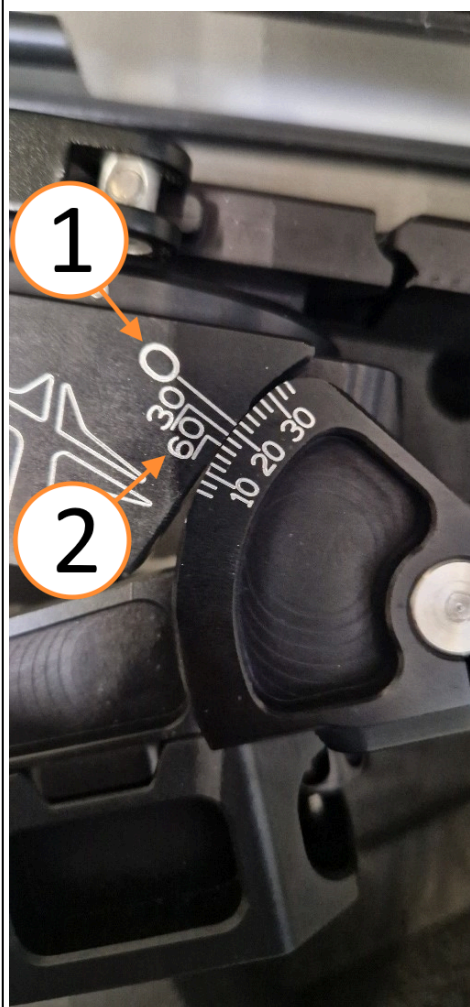

In this example the elevation alignment is set at 21°:

1. 0 is greater than 20°, but less than 22°
2. The next possible alignment of the 60' of arc is made, without exceeding 22°. This achieves the additional 1° to give a total of 21°
3. Note that there are two points of alignment for the 30' in the above scenarios. These will be at 20.5° and 21.5°.

Care must be taken in monitoring the sequence of alignments to ensure correct setting is made.

Azimuth (toe-in) Scale

The azimuth scale works identically to the main elevation scale, and is in 1° increments, with vernier markings for +/- 30' of arc (+/- 0.5°)

Set the Alignment Tool

Set the elevation and toe in vernier scale on the alignment tool, according to the application angle in Appendix C" Alignment Guidance'. **Take note of the correct reference bubble level 'A' or 'B'.**

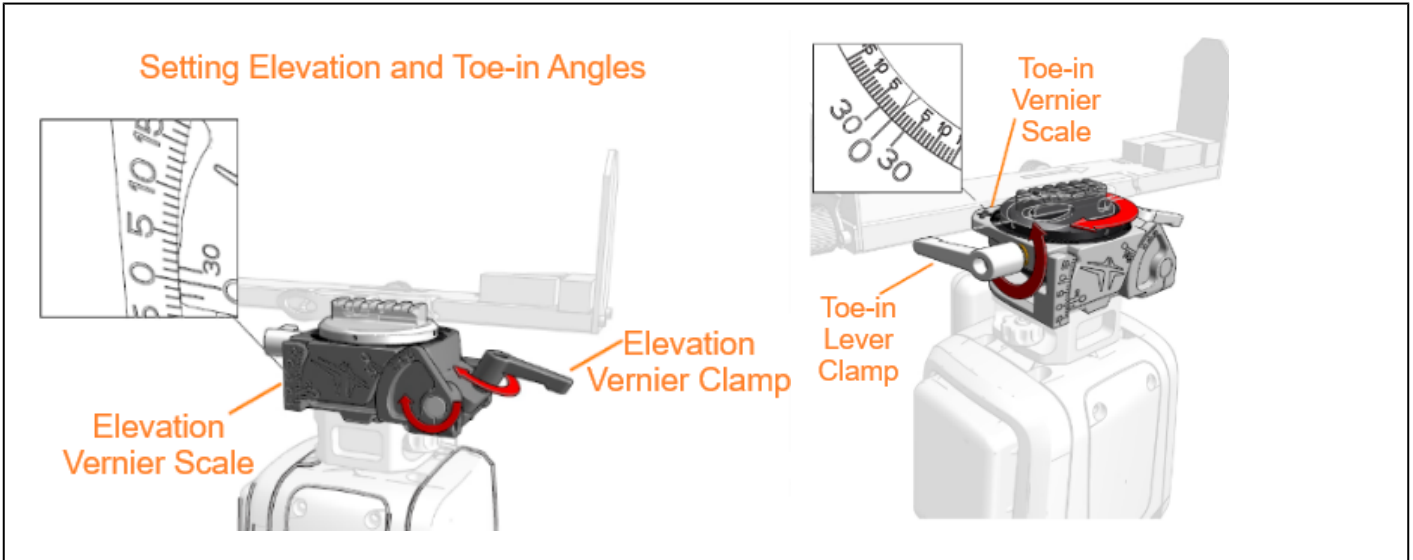

60mm Mount Elevation and Toe-In Setting

Toe-In adjustment is via the 3 fixing screws, securing the light fixture to the frangible coupling or mast (fig 1). Loosen the screws and sight through the mirror of the open sighting device to obtain correct toe-in. When correctly aligned, secure the alignment by progressively tightening the screws to 8Nm (70 in-lbs). Secure the locking nuts to prevent loosening.

Vertical adjustment is via the central barrel screw (fig 2). Adjust until the correct bubble level is centered. Secure the elevation by tightening the locking screw to 8Nm (70 in-lbs). Secure the locking nut to prevent loosening.



IMPORTANT

Excessive torque of adjustment screws or adjustment of barrel screw while locking screw is fixed, may cause damage to the fixture.

Figure 1: Figure 1

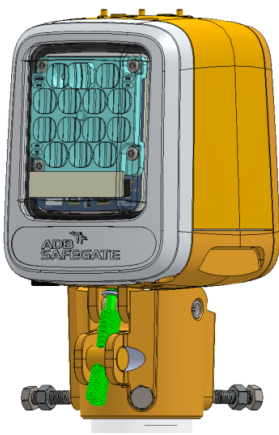

Figure 2: Figure 2

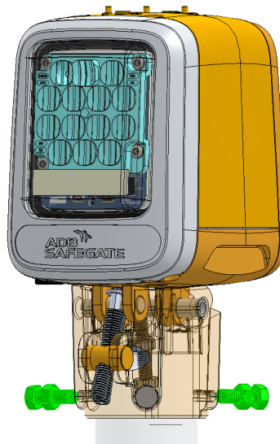
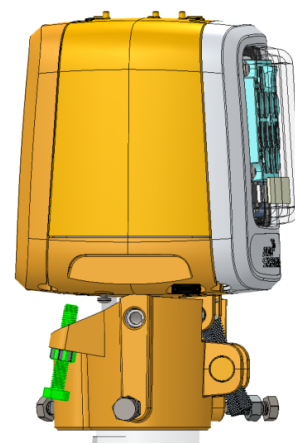

Figure 3: Figure 3



Column Mount Elevation & Toe-In Setting

Vertical & toe-in adjustment is via the 3 fixing screws, securing the light fixture to the column (fig 4). Loosen the screw and sight through the mirror of the open sighting device to obtain correct toe-in. Further adjust until the correct bubble level is centered. Secure the fixture by tightening the locking screw to 8Nm (70 in-lbs). Secure the locking nut to prevent loosening.

Figure 4: Figure 4

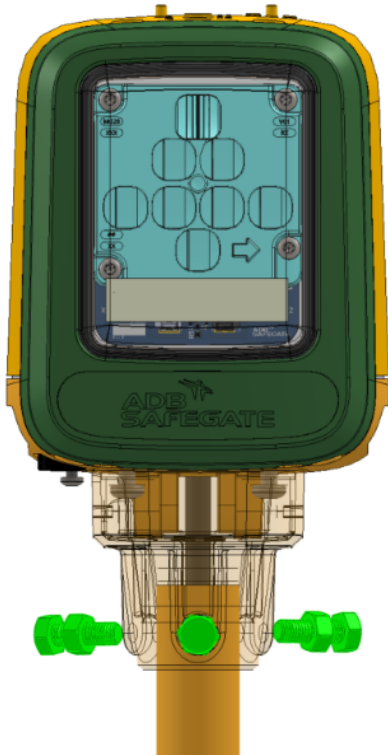

5.0 Maintenance

Maintenance personnel must refer to the maintenance procedure described in the ICAO Airport Services Manual, Part 9, Airport maintenance practices and in FAA Advisory Circular AC150/5340-26.



WARNING

Do not carry out any action on the fixture unless you have read and understood all the information in the Safety chapter.





DANGER

MAKE SURE THAT THE POWER TO THE SERIES CIRCUIT IS OFF WHEN YOU CARRY OUT MAINTENANCE.

5.1 Basic Maintenance Program

Basic Maintenance Program

Frequency	Check	Action
Daily	For low light output according to ICAO annex 14	<ul style="list-style-type: none"> If the Optical Cover is dirty, clean the optical cover with warm water only. If the Optical Cover is not dirty, <ul style="list-style-type: none"> check for correct alignment replace the complete fixture head replace the faulty optical module or component in the workshop.
		<div style="border: 1px solid black; padding: 5px;">  <p>Note Refer to the Complete Optical Cartridge section.</p> </div>
Weekly	For contamination	Clean the fixture with warm water only.
Monthly	Visually for condensation on inner side of the optical cover (presence of moisture or water) Condensation is an acceptable phenomenon, as long as it disappears when the equipment is in use	Turn on the fixture for 30 minutes.
	For failed fixture	<ul style="list-style-type: none"> Replace the complete fixture head Troubleshoot the failure in the workshop.
		<div style="border: 1px solid black; padding: 5px;">  <p>Note Refer to the Complete Optical Cartridge section.</p> </div>

Frequency	Check	Action
Semi-annually	For presence of water at the inside of the fixture	<ul style="list-style-type: none"> In the workshop: Remove the Optical Cover. Dry and clean the Optical Cover. Replace all sealing gasket. Install the dry Optical Cover.
	For watertightness	<ul style="list-style-type: none"> Replace gaskets for Optical and Electronic Cartridges.
	For correct alignment and if the fixture is level.	Adjust the alignment or level the fixture.
	For damaged paint	<ul style="list-style-type: none"> Clean the fixture. Apply touch up paint to prevent corrosion.
Annually	For cracks, corrosion or short circuit	Clean the fixture and replace faulty or corroded parts.
	For dirty contacts	<ul style="list-style-type: none"> Make sure that the power is OFF. Clean the contact.
	For loose connections	Tighten or repair the connection.
After snow removal	For damaged fixture	<ul style="list-style-type: none"> Remove any debris or left over parts. Install a new fixture.



Note

Refer to the Installation chapter.



Note

Refer to the Complete Optical Cartridge section.



Note

Refer to the Installation chapter.



Note

Except for the complete replacement of the fixture, all component module replacements must be done in the workshop.

5.2 Workshop Maintenance - Spare Part Replacement



Note

Refer to the Components section for instructions on how to correctly replace parts.

Optical Module Replacement

1. Remove 4 Torx screws. 2 are located at the top, 2 are located at the bottom and are the inner most pair.



2. Pull optical module away from the light body. Take care not to damage cable by pulling further than the cables will reach).



Note

The O-rings are designed to ensure a secure, watertight seal, which may make the optical module feel tight during removal. If needed, we recommend using a plastic pry tool between the light body and the optical module. Gently work around the perimeter to ensure even removal.

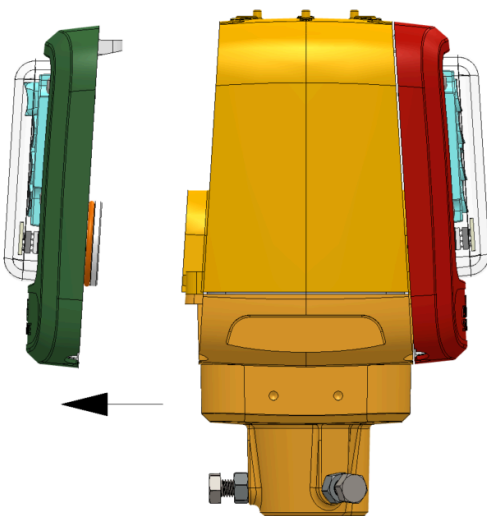

3. Disconnect LED cables from light engine assembly, but gently pulling in direction of arrow.

4. Connect LED cables to new light engine assembly (note they are oriented, so it is not possible to make an incorrect connection)
5. Ensure light engine o-rings (A) are lightly greased with versilube grease or similar, and main light body aperture is clean and undamaged. Ensure new o-rings are used.

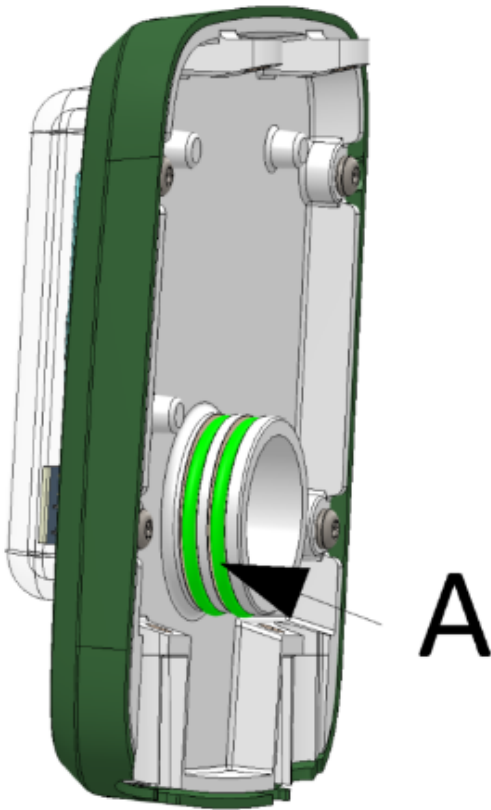

6. Gently inset optical module into light body housing until screw holes align top and bottom. Excessive force should not be required. Light engine should be inserted parallel to the light body to avoid damage or misalignment to the two sealing o-rings. Ensure LED cables are within the body and do not get pinched.

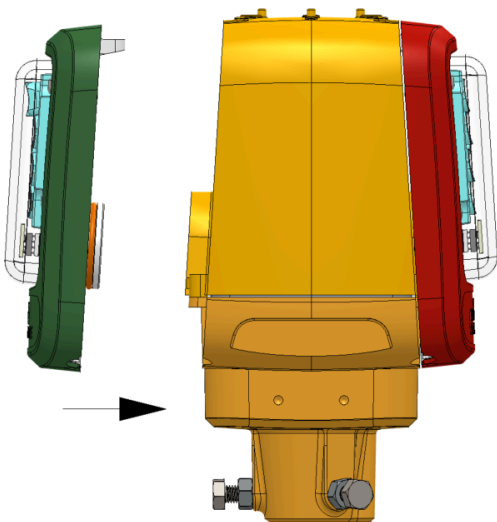

7. Insert new torx screws top and bottom (do not re-use old screws, as they utilise pre-applied Loctite). Torque to 22 in-lbs (tightening sequence is not important).
8. **IMPORTANT - LED MODULE CALIBRATION!** The light must be powered up at 6.6. After c. 10 seconds the LEDs will blink 3 times to confirm successful calibration. If this does not happen, switch off and re-check all steps in this process are successful and complete.

Optical Blank Cover (similar to optical module replacement)

1. Remove 4 Torx screws. 2 are located at the top, 2 are located at the bottom, and are the inner most pair.
2. Pull optical blank cover away from the light body.
3. Ensure optical blank cover o-rings are lightly greased with versilube grease or similar, and main light body aperture is clean and undamaged. Ensure new o-rings are used.
4. Gently inset optical blank cover into light body housing until screw holes align top and bottom. Excessive force should not be required. Light engine should be inserted parallel to the light body to avoid damage or misalignment to the two sealing o-rings.
5. Insert new torx screws top and bottom (do not re-use old screws, as they utilize pre-applied Loctite). Torque to 22 in-lbs (tightening sequence is not important).

Power Supply Board

1. Remove 4 screws on the bottom of the light body. There are the outermost pairs of screws on each side.



2. Pull lower housing away from upper housing assembly. Take care not to damage cables by pulling further than the cables will reach.

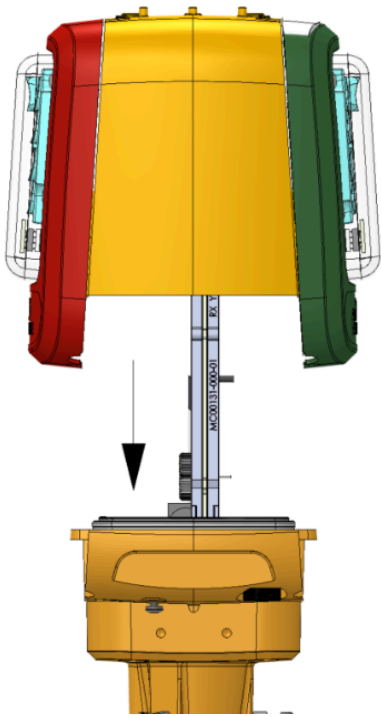

3. Disconnect LED cables from the power supply board.
4. EQ ONLY – Disconnect IOT module power cable from the power supply board.
5. Disconnect input power & earth cable from power supply board. They are disconnected by lifting the connector levers.

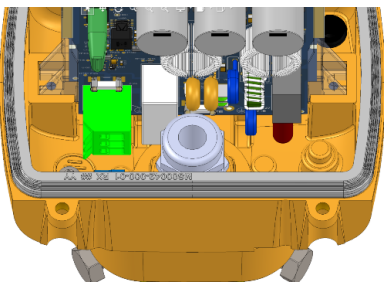

6. Remove two screws securing the power supply board to lower housing and remove power supply board.

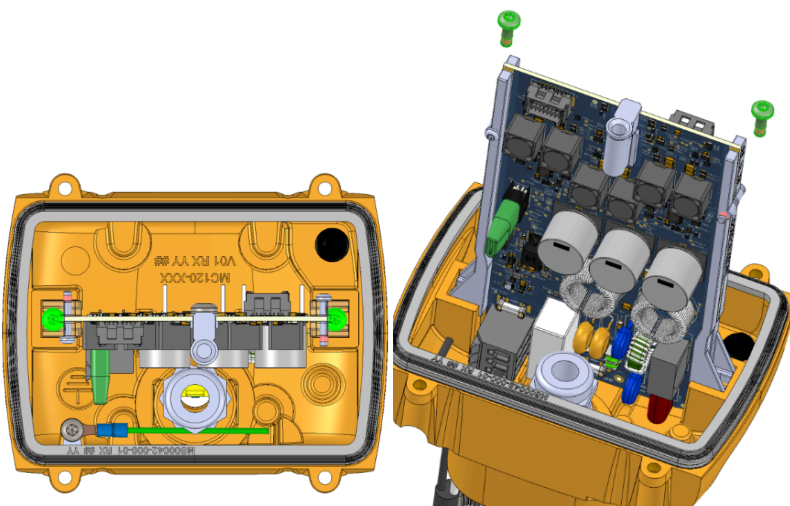

7. Insert new power supply board and secure with new torx screws. Do not re-use old screws, as they utilise pre-applied Loctite. Torque to 22 in-lbs (tightening sequence is not important).

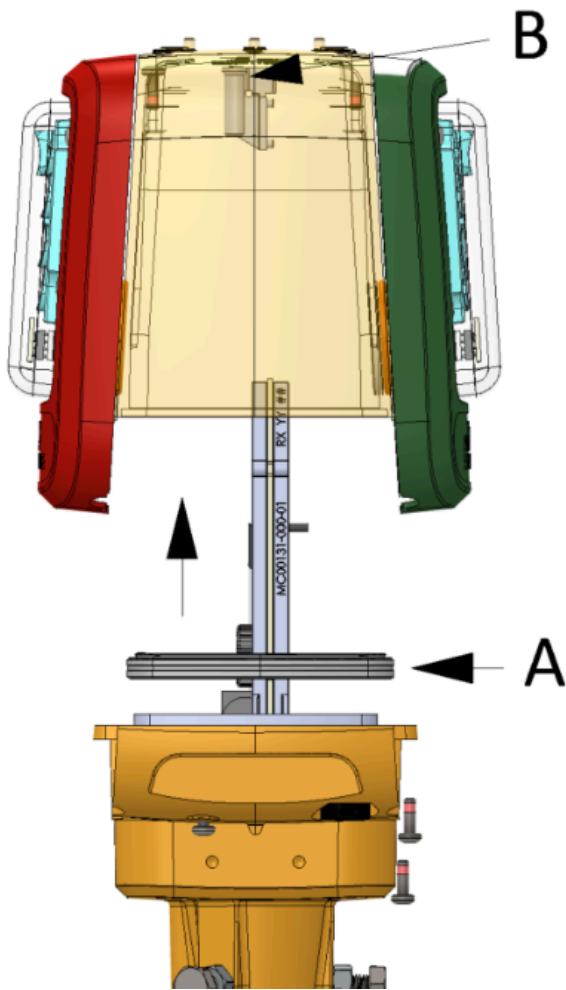

8. Insert input power & earth cable into connector, taking care to orient as per diagram below. Cables are secured by pushing lever fully down. After securing the connector levers, gently tug on wires to ensure secure installation.
9. Remove old lower housing seal and install new seal (A) . Check the sealing faces of both the lower & upper housing to ensure cleanliness and no damage and surfaces are clean. If cleaning is necessary, only use a plastic scraper and alcohol based cleaner.
10. Hold the lower housing assembly in correct orientation relative to the upper housing assembly and re-connect LED cables to the power supply board.
11. **EQ ONLY** – Reconnect IOT module power cable to the power supply board.
12. Insert lower housing assembly into upper housing assembly until seated, and flush with the bottom of the optical modules, and screw holes are aligned.
13. Take care to align upper housing power supply locating pin with the receptacle on the power supply board (B)
14. Ensure the gasket is correctly seated and not pinched or twisted.
15. Ensure correct alignment of the lower housing assembly, with the upper housing and optical modules.

16. Insert new torx screws (do not re-use old screws, as they utilise pre-applied Loctite). Torque to 22 in-lbs, in the following diagonal sequence:

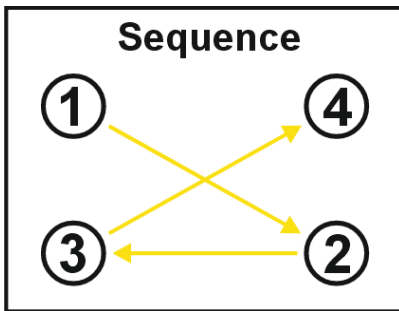

EQ IOT Module

1. To retrofit RF IOT Modules to EQ fixtures, first remove the three torx screws securing the blanking piece in place. Gently pry outwards with a plastic pry tool to release the blank – the sealing methodology is the same as the optical modules.
2. Ensure RF IOT module o-rings are lightly greased with versilube grease or similar, and main light body aperture is clean and undamaged. Ensure new o-rings are used.
3. Withdraw RF IOT module power connector, via the main body opening, and connect to the module.
4. Gently inset RF IOT module into light body housing until firmly positioned and screw holes are aligned. Excessive force should not be required. RF IOT Module should be inserted parallel to the light body to avoid damage or misalignment to the two sealing o-rings. Ensure LED cables are within the body and do not get pinched.
5. Insert three new torx screws (do not re-use old screws, as they utilise pre-applied Loctite). Torque to 22 in-lbs (tightening sequence is not important).

Lens Cover (glass/plastic)

1. Follow procedure to replace optical module to step 3.
2. Unscrew 4 torx screws on rear of optical heatsink and remove light engine trim and then lens and gasket.
3. Mount new lens seal (A) to new lens (B), ensuring it's evenly fitted and is not wrinkled. Place the lens assembly through the light engine trim, ensuring it's fully seated.
4. Fit the optical heatsink, ensuring that it's evenly positioned and flush with the surrounding light engine trim.
5. Insert new torx screws (do not re-use old screws, as they utilise pre-applied Loctite). Torque to 22 in-lbs, in the following diagonal sequence:

Sequence
6. Ensure new o-rings are fitted.
7. Reassemble the optical module to the light body, following procedure to replace optical module from step 4.

Blanking Screw

1. Unscrew existing blanking screw from housing with a 10mm hex key.
2. Install new blanking screw, ensuring seal is present and threaded hole in lower light assembly is clean. Torque to 2.5Nm (22 in-lbs).

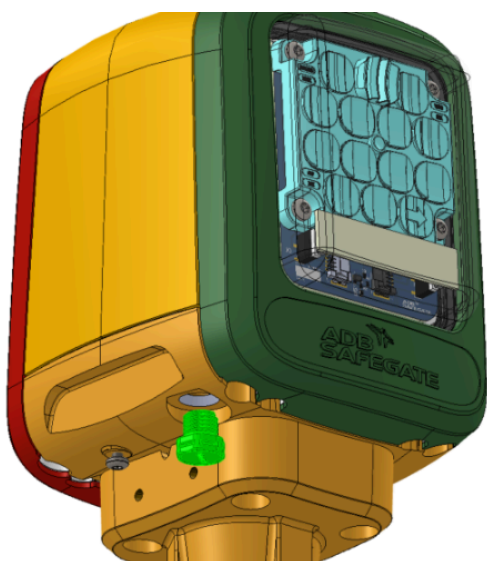

Input Power Cable

1. Follow procedure to remove lower mount.
2. Follow procedure for Power Supply Board Replacement, to step 6
3. Remove ferrite from power supply cable by unwinding cable loops. Unscrew cable gland nut on the exterior of the lower housing.

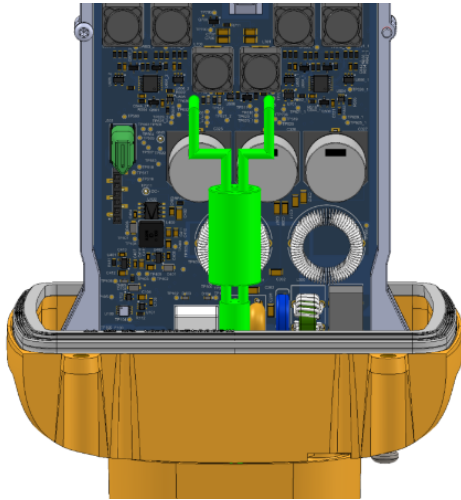

4. Unscrew cable gland cap and withdraw cable from gland and remove gland.

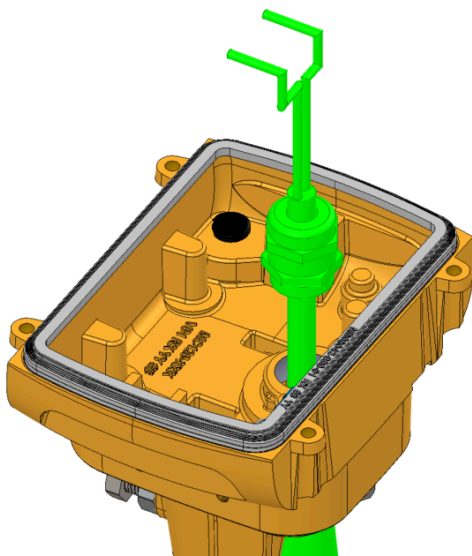

5. To fit new cable, ensure a new gland is also used.
6. Insert corset through gland nut and lower housing body from the outside.
7. Push cordset through gland body and loosely tighten the gland to the lower housing with the gland nut.
8. Ensure 7" of cable is present, measured from the inside of the lower housing assembly to the end of the cordset.
9. Torque the cable gland nut to 6.2Nm (55 in-lbs) to secure to the lower housing assembly. Torque the gland cap to 2.5Nm (55 in-lbs) to ensure correct sealing of the gland to the cordset.
10. Insert the 7" of the exposed cordset through the new ferrite and loop the cables through once, ensuring the ferrite is as close to the gland as possible.
11. Follow procedure for power supply board replacement, from step 7 to completion.

Column Mount

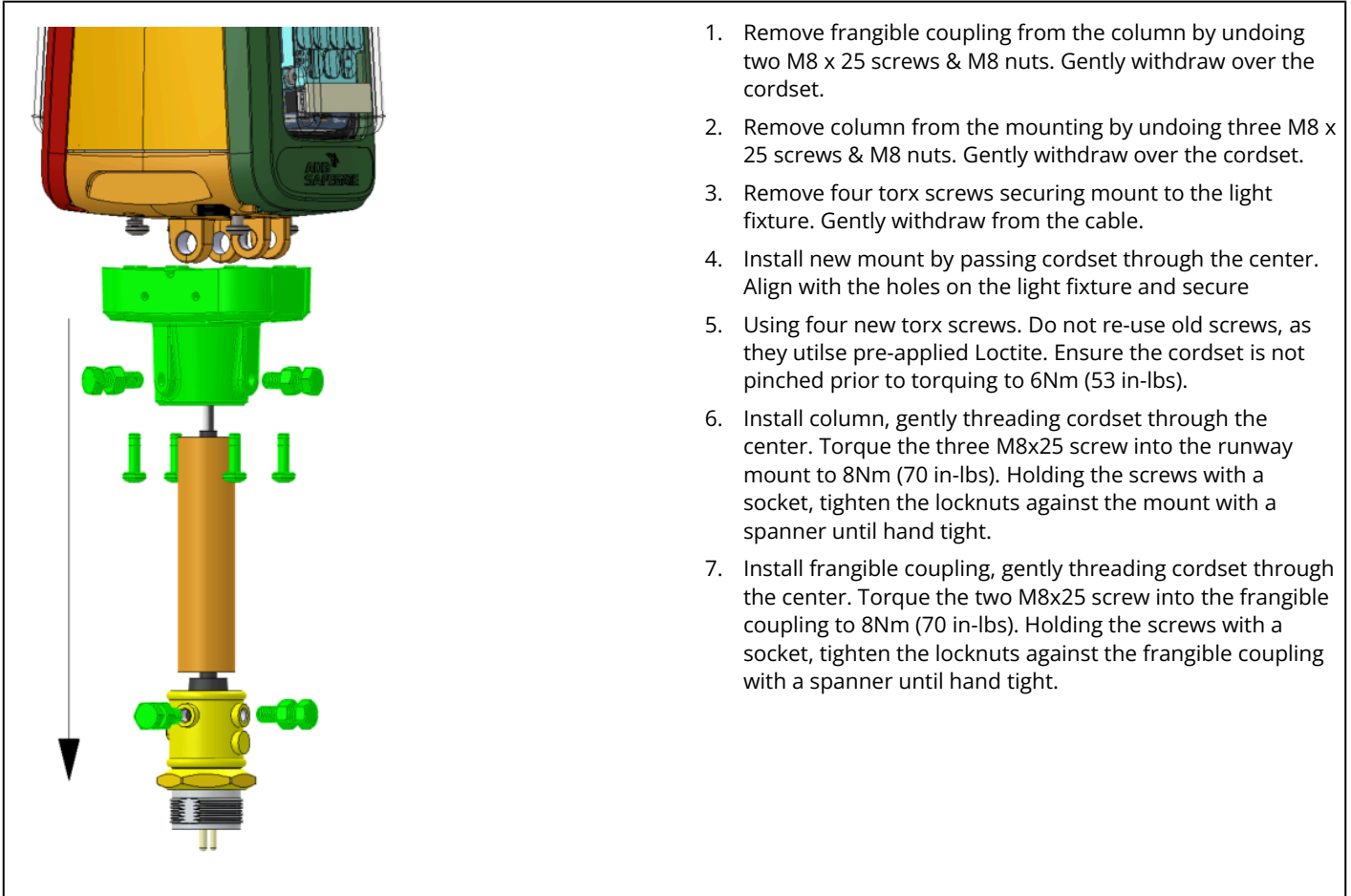

Screws Overview (Torque Table)

Name	Screw Type	Torque	
		in/lbs	Nm
Optical Module - Light engine trim to optical heatsink.	M4x8	22	2.5
Optical Module / Blank to main housing / lower housing	M4x12	22	2.5
Lower Housing to Main Housing	M4x12	22	2.5
Blanking Plug	M12 Plug	22	2.5
Alignment Mounting Blanking Screws	M5 x 8	22	2.5
Column mount to lower housing	M6x20	53	6
Column to mounting screws (upper)	M8x25	70	8
Column to frangible coupling	M8x25	70	8
Power Supply mounting screws to lower housing	M4x12	22	2.5
Internal ground wire to lower housing	M4x12	22	2.5
External ground wire to lower housing	M4x12	22	2.5
Input Cable Gland - (gland to body & gland cap)	Cordset Gland	55	6.2
IoT module / blank to main housing	M4x8	22	2.5

6.0 Ordering Codes

6.1 ICAO Approach Centerline and Siderow

Ordering Code

Application	Standards	Market Specific	Lens Type	Toe-in	Color - Side 1 (Left)	Color - Side 2 (Right)	Omnidirectional	Power Supply	Cable and Connector	Fixture Height	Coupling	Option 2	Advanced Connectivity	Refurbished	Version control
A															

<p>Application AC = Approach centerline / cross bar AS = Approach siderow</p> <p>Standards 2 = FAA 3 = ICAO</p> <p>Market Specific 0 = None 1 = Buy American preference (BAP) 4 = German MIL 7-step</p> <p>Lens Type G = Glass P = UV resistant polycarbonate</p> <p>Toe-in N = No toe-in</p> <p>Color - Side 1 (Left) W = White R = Red</p>	<p>Color - Side 2 (Right) N = None (obscured)</p> <p>Omnidirectional 0 = None 3 = Low intensity approach omni light (white) 4 = Low intensity approach omni light (red)</p> <p>Power Supply S = No monitoring M = With monitoring</p> <p>Cable and Connector 2 = 1 x style 1 2-pole plug, jacketed SO 2 core cable¹ 7 = 2 individual wires, 16-18 AWG, 90" length, non terminated</p> <p>Fixture Height A = Approach mount for 60 mm mast or pole²</p> <p>Coupling A = No coupling (for approach only)</p> <p>Option 2 0 = None 1 = Smart arctic kit 3 = Near infra red 4 = Smart arctic kit & near infra red</p> <p>Advanced Connectivity 0 = 0</p> <p>Refurbished 0 = 0</p> <p>Version control 1 = 1</p>
--	--

Ordering Code Notes

1. With separate earth for external routing
2. Also for 60 mm coupling or base plate

6.2 ICAO Stop Bar

Ordering Code

Application	Standards	Market Specific	Lens Type	Toe-in	Color - Side 1 (Left)	Color - Side 2 (Right)	Omnidirectional	Power Supply	Cable and Connector	Fixture Height	Coupling	Option 2	Advanced Connectivity	Refurbished	Version control
A															

Application

SB = Stop bar

Standards

3 = ICAO

Market Specific

0 = None

Lens Type

G = Glass

P = UV resistant polycarbonate

Toe-in

N = No toe-in

Color - Side 1 (Left)

R = Red

Color - Side 2 (Right)

N = None (obscured)

Omnidirectional

0 = None

Power Supply

S = No monitoring

M = With monitoring

Cable and Connector

1 = 1 x style 6 2-pole plug, 2 individual wires¹

2 = 1 x style 1 2-pole plug, jacketed SO 2 core cable²

Fixture Height

B = <350mm

C = 14" OAH

D = 20" OAH

E = 24" OAH

F = 30" OAH

Coupling

B = 2" 11TPI (BSP) coupling no base plate

C = 2" 11.5TPI (NPS) coupling no base plate

E = 2" 11TPI (BSP) flush break coupling no base plate

F = 2" 11.5TPI (NPS) flush break coupling no base plate

Option 2

0 = None

1 = Smart arctic kit

3 = Near infra red

4 = Smart arctic kit & near infra red

Advanced Connectivity

0 = 0

Refurbished

0 = 0

Version control

1 = 1

Ordering Code Notes

1. With separate earth for internal routing
2. With separate earth for external routing

6.3 ICAO Runway Threshold, Threshold/End, End and Threshold Wingbar

Ordering Code

Application	Standards	Market Specific	Lens Type	Toe-in	Color - Side 1 (Left)	Color - Side 2 (Right)	Omnidirectional	Power Supply	Cable and Connector	Fixture Height	Coupling	Option 2	Advanced Connectivity	Refurbished	Version control
A															

Application

RT = Runway threshold/end
 RN = Runway end
 RW = Runway threshold wingbar

Standards

3 = ICAO

Market Specific

0 = None
 4 = German MIL 7-step

Lens Type

G = Glass
 P = UV resistant polycarbonate

Toe-in

L = Side 1 – left toe-in
 R = Side 2 – right toe-in
 N = No toe-in

Color - Side 1 (Left)

R = Red
 F = Green
 N = None (obscured)

Color - Side 2 (Right)

R = Red
 F = Green
 N = None (obscured)

Ordering Code Notes

1. With separate earth for internal routing
2. With separate earth for external routing

Omnidirectional

0 = None

Power Supply

S = No monitoring
 M = With monitoring

Cable and Connector

1 = 1 x style 6 2-pole plug, 2 individual wires¹
 2 = 1 x style 1 2-pole plug, jacketed SO 2 core cable²

Fixture Height

B = <350mm
 C = 14" OAH
 D = 20" OAH
 E = 24" OAH
 F = 30" OAH

Coupling

B = 2" 11TPI (BSP) coupling no base plate
 C = 2" 11.5TPI (NPS) coupling no base plate
 E = 2" 11TPI (BSP) flush break coupling no base plate
 F = 2" 11.5TPI (NPS) flush break coupling no base plate

Option 2

0 = None
 1 = Smart arctic kit
 3 = Near infra red
 4 = Smart arctic kit & near infra red

Advanced Connectivity

0 = 0

Refurbished

0 = 0

Version control

1 = 1

6.4 Stopway

Ordering Code

	Application	Standards	Market Specific	Lens Type	Toe-in	Color - Side 1 (Left)	Color - Side 2 (Right)	Omnidirectional	Power Supply	Cable and Connector	Fixture Height	Coupling	Option 2	Advanced Connectivity	Refurbished	Version control
A	<input type="checkbox"/>	<input type="checkbox"/>	<input type="checkbox"/>	<input type="checkbox"/>	<input type="checkbox"/>	<input type="checkbox"/>	<input type="checkbox"/>	<input type="checkbox"/>	<input type="checkbox"/>	<input type="checkbox"/>	<input type="checkbox"/>	<input type="checkbox"/>	<input type="checkbox"/>	<input type="checkbox"/>	<input type="checkbox"/>	<input type="checkbox"/>

Application

SW = Stop way

Standards

3 = ICAO

Market Specific

0 = None

4 = German MIL 7-step

Lens Type

G = Glass

P = UV resistant polycarbonate

Toe-in

L = Side 1 – left toe-in

R = Side 2 – right toe-in

Color - Side 1 (Left)

R = Red

N = None (obscured)

Color - Side 2 (Right)

R = Red

N = None (obscured)

Omnidirectional

0 = None

Power Supply

S = No monitoring

M = With monitoring

Cable and Connector

1 = 1 x style 6 2-pole plug, 2 individual wires¹

2 = 1 x style 1 2-pole plug, jacketed SO 2 core cable²

Fixture Height

B = <350mm

C = 14" OAH

D = 20" OAH

E = 24" OAH

F = 30" OAH

Coupling

B = 2" 11TPI (BSP) coupling no base plate

C = 2" 11.5TPI (NPS) coupling no base plate

E = 2" 11TPI (BSP) flush break coupling no base plate

F = 2" 11.5TPI (NPS) flush break coupling no base plate

Option 2

0 = None

1 = Smart arctic kit

3 = Near infra red

4 = Smart arctic kit & near infra red

Advanced Connectivity

0 = 0

Refurbished

0 = 0

Version control

1 = 1

Ordering Code Notes

1. With separate earth for internal routing
2. With separate earth for external routing

6.5 L-862S(L) FAA Stop Bar

Ordering Code

Application	Standards	Market Specific	Lens Type	Toe-in	Color - Side 1 (Left)	Color - Side 2 (Right)	Omnidirectional	Power Supply	Cable and Connector	Fixture Height	Coupling	Option 2	Advanced Connectivity	Refurbished	Version control
A															

Application

SB = L-862S(L) stop bar

Standards

2 = FAA

Market Specific

0 = None

1 = Buy American preference (BAP)

Lens Type

G = Glass

P = UV resistant polycarbonate

Toe-in

N = No toe-in

Color - Side 1 (Left)

R = Red

Color - Side 2 (Right)

N = None (obscured)

Omnidirectional

0 = None

Power Supply

S = No monitoring

M = With monitoring

Cable and Connector

1 = 1 x style 6 2-pole plug, 2 individual wires¹

Fixture Height

C = 14" OAH

D = 20" OAH

E = 24" OAH

F = 30" OAH

Coupling

C = 2" 11.5TPI (NPS) coupling no base plate

Option 2

0 = None

1 = Smart arctic kit

3 = Near infra red

4 = Smart arctic kit & near infra red

Advanced Connectivity

0 = 0

Refurbished

0 = 0

Version control

1 = 1

Ordering Code Notes

1. With separate earth for internal routing

6.6 L-862(L) Runway Edge

Ordering Code

Application	Standards	Market Specific	Lens Type	Toe-in	Color - Side 1 (Left)	Color - Side 2 (Right)	Omnidirectional	Power Supply	Cable and Connector	Fixture Height	Coupling	Option 2	Advanced Connectivity	Refurbished	Version control
A															

Application

RE = Runway edge L-862(L)

Standards

1 = ICAO & FAA

Market Specific

0 = None

1 = Buy American preference (BAP)

4 = German MIL 7-step¹

Lens Type

G = Glass

P = UV resistant polycarbonate

Toe-in

L = Side 1 – left toe-in

R = Side 2 – right toe-in

C = Both sides with toe-in

Color - Side 1 (Left)

W = White

Y = Yellow

R = Red

F = Green

N = None (obscured)

Color - Side 2 (Right)

W = White

Y = Yellow

R = Red

F = Green

N = None (obscured)

Ordering Code Notes

1. Not ETL submitted or not applicable to FAA market.
2. With separate earth for internal routing
3. With separate earth for external routing

Omnidirectional

0 = None

1 = Dimmable circling guidance

2 = Constant intensity circling guidance

Power Supply

S = No monitoring

M = With monitoring

Cable and Connector

1 = 1 x style 6 2-pole plug, 2 individual wires²

2 = 1 x style 1 2-pole plug, jacketed SO 2 core cable³

Fixture Height

B = <350mm¹

C = 14" OAH

D = 20" OAH

E = 24" OAH

F = 30" OAH

Coupling

B = 2" 11TPI (BSP) coupling no base plate¹

C = 2" 11.5TPI (NPS) coupling no base plate

D = 1.5" 12TPI coupling no base plate

E = 2" 11TPI (BSP) flush break coupling no base plate¹

F = 2" 11.5TPI (NPS) flush break coupling no base plate¹

Option 2

0 = None

1 = Smart arctic kit

3 = Near infra red

4 = Smart arctic kit & near infra red

Advanced Connectivity

0 = 0

Refurbished

0 = 0

Version control

1 = 1

6.7 L-862E(L) FAA Runway Threshold, Threshold/End and End

Ordering Code

Application	Standards	Market Specific	Lens Type	Toe-in	Color - Side 1 (Left)	Color - Side 2 (Right)	Omnidirectional	Power Supply	Cable and Connector	Fixture Height	Coupling	Option 2	Advanced Connectivity	Refurbished	Version control
A															

Application

RT = L-862E(L) runway threshold/end

RN = L-862E(L) runway end

Standards

2 = FAA

Market Specific

0 = None

1 = Buy American preference (BAP)

Lens Type

G = Glass

P = UV resistant polycarbonate

Toe-in

L = Side 1 – left toe-in

R = Side 2 – right toe-in

N = No toe-in

Color - Side 1 (Left)

R = Red

F = Green

N = None (obscured)

Color - Side 2 (Right)

R = Red

F = Green

N = None (obscured)

Omnidirectional

0 = None

Power Supply

S = No monitoring

M = With monitoring

Cable and Connector

1 = 1 x style 6 2-pole plug, 2 individual wires¹

Fixture Height

C = 14" OAH

D = 20" OAH

E = 24" OAH

F = 30" OAH

Coupling

C = 2" 11.5TPI (NPS) coupling no base plate

D = 1.5" 12TPI coupling no base plate

Option 2

0 = None

1 = Smart arctic kit

3 = Near infra red

4 = Smart arctic kit & near infra red

Advanced Connectivity

0 = 0

Refurbished

0 = 0

Version control

1 = 1

Ordering Code Notes

1. With separate earth for internal routing

7.0 Spare Parts

7.1 AXON Elevated

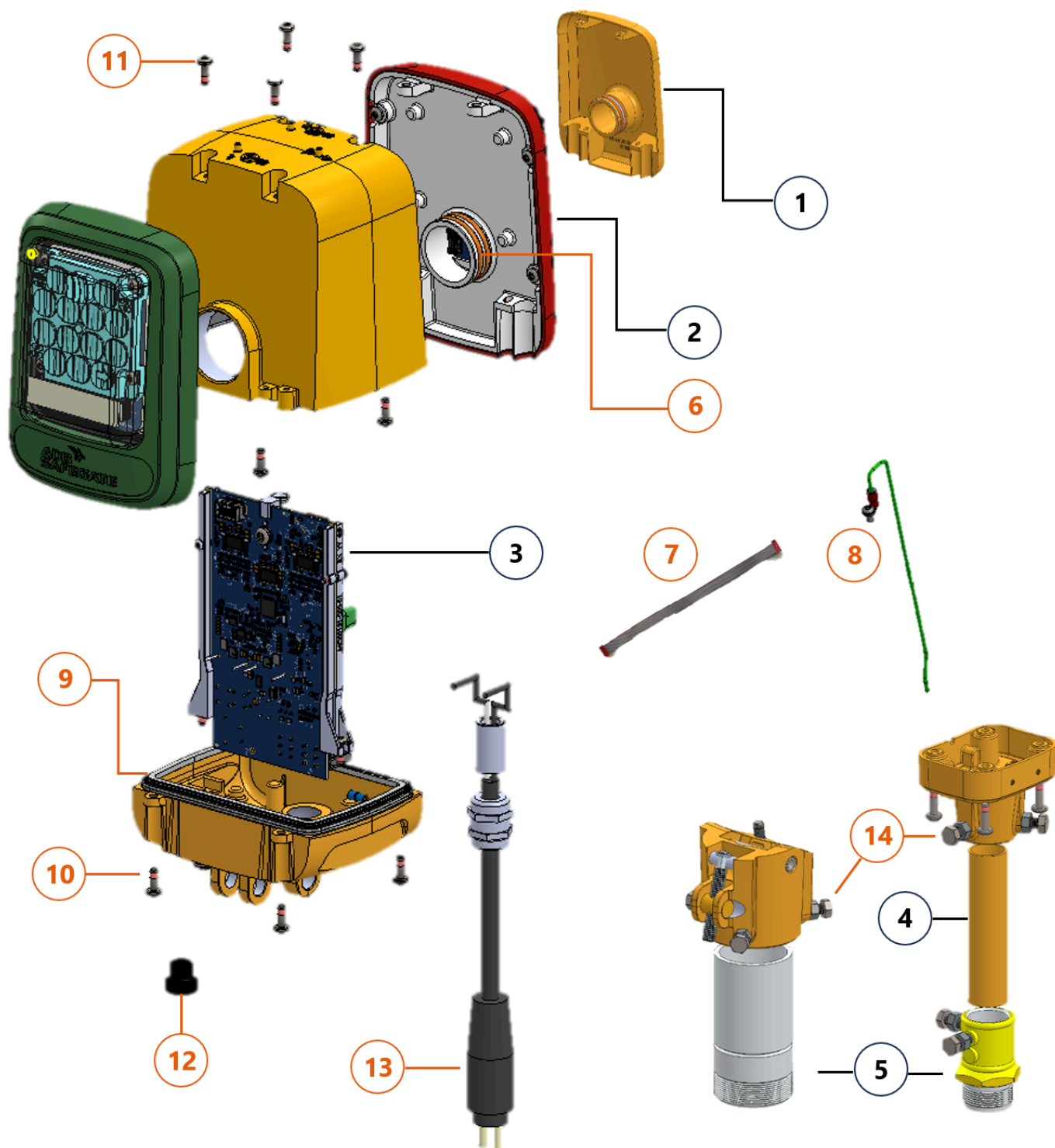

Call-Out	Description	Kit Qty	Spare Part Number
1	Optical Blanking Module Kit	1	SP.AS312-Blank
2	Optical Module & components	(see below)	
3	Power Supply Board	(see below)	

Call-Out	Description	Kit Qty	Spare Part Number	
4	Column Mount - Mounting Column	<350mm Height	1	SP.62A0007/2
		14" OAH	1	SP.62A0007/14
		20" OAH	1	SP.62A0007/20
		24" OAH	1	SP.62A0007/24
		30" OAH	1	SP.62A0007/30
5	Column Mount - Frangible Coupling (including screws & nuts)	2" 11 TPI thread, less than 30" OAH	1	SP.4072.65.570
		2" 11.5 TPI thread, less than 30" OAH	1	SP.4072.65.580
		1.5" 12 TPI thread, less than 30" OAH	1	SP.4072.65.550
		2" 11 TPI thread, 30" OAH	1	SP.4072.65.600
		2" 11.5 TPI thread, 30" OAH	1	SP.4072.65.610
		1.5" 12 TPI thread, 30" OAH	1	SP.4072.65.560
		ICAO Flush - 2" 11 TPI thread, less than 30" OAH	1	SP.MC135-10S
		ICAO Flush - 2" 11.5 TPI thread, less than 30" OAH	1	SP.MC00135-15S
		ICAO Flush - 2" 11 TPI thread, 30" OAH	1	SP.MC00135-10H
		ICAO Flush - 2" 11.5 TPI thread, 30" OAH	1	SP.MC00135-15H
	60mm Mount Frangible Coupling (including screws & nuts)	2" 11 TPI thread, less than 350mm OAH	1	SP1409.06.021
		2" 11.5 TPI thread, less than 350mm OAH	1	SP4072.65.540
		2" 11 TPI thread, 14" OAH	1	SP.MM421-004
		2" 11.5 TPI thread, 14" OAH	1	SP.MM421-504
		2" 11 TPI thread, 20" OAH	1	SP.MM421-010
		2" 11.5 TPI thread, 20" OAH	1	SP.MM421-510
		2" 11 TPI thread, 24" OAH	1	SP.MM421-014
		2" 11.5 TPI thread, 24" OAH	1	SP.MM421-514
		2" 11 TPI thread, 30" OAH	1	SP.MM421-020
		2" 11.5 TPI thread, 30" OAH	1	SP.MM421-520
6	Optical Module O-Ring	50	SP.MS00001-126	
		20	SP.EW00149-150	
7	LED Cable Harness – Power supply to LED Board	20	SP.EW00149-150	
8	External Earthing Cable	5	SP.44A7644/2	
9	Main Body Gasket	20	SP.MS00042-000	
10&11	Optical Module & Main Body Screw Kit (with pre-applied Loctite)	80	SP.MFPM4PT-612	
12	Blanking Plug	10	SP.MS00057-204	
13	Input Power Cable Kit	Style 6 2-Pole Plug, 2 individual wires. Including gland & ferrite & required consumables. <350mm & 14" OAH	5	SP.00113-018
		Style 6 2-Pole Plug, 2 individual wires. Including gland & ferrite & required consumables. 20" OAH	5	SP.00113-020
		Style 6 2-Pole Plug, 2 individual wires. Including gland & ferrite & required consumables. 24" OAH	5	SP.00113-024

Call-Out	Description	Kit Qty	Spare Part Number
	Style 6 2-Pole Plug, 2 individual wires. Including gland & ferrite & required consumables. 30" OAH	5	SP.00113-030
	Style 1 2-Pole Plug, Jacketed SP 2 core cable for external routing. Including gland & ferrite & required consumables. <350mm & 14" OAH	5	SP.00114-024
	Style 1 2-Pole Plug, Jacketed SP 2 core cable for external routing. Including gland & ferrite & required consumables. 20" OAH	5	SP.00114-030
	Style 1 2-Pole Plug, Jacketed SP 2 core cable for external routing. Including gland & ferrite & required consumables. 24" OAH	5	SP.00114-034
	Style 1 2-Pole Plug, Jacketed SP 2 core cable for external routing. Including gland & ferrite & required consumables. 30") OAH	5	SP.00114-040
	Style 6 Plug, 2 Individual Wire, 16-18 AWG, 90" length. Including gland & ferrite & required consumables.	5	SP.00113-104
14	M8 Screw & Nut for alignment or frangible coupling.	60	SP.00116-000-01

7.2 Optical Module



Call-Out	Description	Kit Qty	Spare Part Number
15	Heater Kit - Axon Elevated	5	SP.EP00151-000
16	Lens Seal - Axon Elevated	5	SP.EP-MS00043-000
17a	Glass Lens - Axon Elevated	5	SP.MG00029-000
17b	Plastic Lens - Axon Elevated	5	SP.MG00029-001



Note

Where omni is available it's always on the LED module. Configuration of the convertor will determine if it's on or off

Call Out	Applications	Lens Type	Arctic Kit Selection	Main Beam Toe-In	Main Beam Color	Low Int. Omni (see note below)	2a - Optical Module Spare Part Number	
							For 5 step dimming curve (standard) SP.AS312-XXXXX	"For 7 Step dimming curve SP.AS396-XXXXX
2	Approach Centreline & Crossbar (AC)	Glass	No AK	Straight	○ W ↑	○ W*		G13HN
					○ W ↑	● R*		G13MN
					N/A	○ W		G13LN
					N/A	● R		G13GN
			With AK	Straight	○ W ↑	○ W*		G13HA

Call Out	Applications	Lens Type	Arctic Kit Selection	Main Beam Toe-In	Main Beam Color	Low Int. Omni (see note below)	2a - Optical Module Spare Part Number	
							For 5 step dimming curve (standard) SP.AS312-XXXXX	"For 7 Step dimming curve SP.AS396-XXXXX
					○ W ↑	● R*		G13MA
					N/A	○ W		G13LA
					N/A	● R		G13GA
					○ W ↑	○ W*		P13HN
			No AK	Straight	○ W ↑	● R*		P13MN
					N/A	○ W		P13LN
		Polycarbonate			N/A	● R		P13GN
					○ W ↑	○ W*		P13HA
			With AK	Straight	○ W ↑	● R*		P13MA
					N/A	○ W		P13LA
					N/A	● R		P13GA
					● R ↑	○ W*		G23KN
			No AK	Straight	● R ↑	● R*		G23AN
					N/A	○ W		G23LN
		Glass			N/A	● R		G23GN
	Approach Side Row (AS)				● R ↑	○ W*		G23KA
			With AK	Straight	● R ↑	● R*		G23AA
					N/A	○ W		G23LA
					N/A	● R		G23GA
		Polycarbonate	No AK	Straight	● R ↑	○ W*		P23KN

Call Out	Applications	Lens Type	Arctic Kit Selection	Main Beam Toe-In	Main Beam Color	Low Int. Omni (see note below)	2a - Optical Module Spare Part Number						
							For 5 step dimming curve (standard) SP.AS312-XXXXX	"For 7 Step dimming curve SP.AS396-XXXXX					
Approach Side Row Flash (SF)			With AK	Straight	● R ↑	● R*		P23AN					
					N/A	○ W		P23LN					
					N/A	● R		P23GN					
					● R ↑	○ W*		P23KA					
					● R ↑	● R*		P23AA					
					N/A	○ W		P23LA					
			No AK	Straight	Glass	N/A	● R ↑	N/A		G2FAN			
						With AK	● R ↑	N/A		G2FAA			
						No AK	Straight	Polycarbonate	● R ↑	N/A		P2FAN	
									With AK	● R ↑	N/A		P2FAA

Call Out	Applications	Lens Type	Arctic Kit Selection	Main Beam Toe-In	Main Beam Color	Low Int. Omni (see note below)	For 5 step dimming curve (standard) SP.AS312-XXXXX	"For 7 Step dimming curve SP.AS396-XXXXX "	
2	ICAO Runway Threshold (RT)	Glass	No AK	Side 1 - Left	● F ↖	N/A		G83BN	
			With AK	Side 1 - Left	● F ↖	N/A		G83BA	
			No AK	Side 1 - Left	Polycarbonate	● F ↖	N/A		P83BN
						With AK	Side 1 - Left	● F ↖	N/A
		Glass	No AK	Side 2 - Right	● F ↗	N/A		G93BN	
			With AK	Side 2 - Right	● F ↗	N/A		G93BA	
			No AK	Side 2 - Right	Polycarbonate	● F ↗	N/A		P93BN
						With AK	Side 2 - Right	● F ↗	N/A

Call Out	Applications	Lens Type	Arctic Kit Selection	Main Beam Toe-In	Main Beam Color	Low Int. Omni (see note below)	For 5 step dimming curve (standard) SP.AS312-XXXXXX	"For 7 Step dimming curve SP.AS396-XXXXXX "
FAA Threshold L-862E (RT)	Glass	No AK	Straight	●	F ↑	N/A	G03BN	
		No AK	Straight	●	F ↑	N/A	P03BN	
	Glass	No AK	Side 1 - Left	●	F ↖	N/A	G82NN	
		No AK	Side 1 - Left	●	F ↖	N/A	P82NN	
	Glass	No AK	Side 2 - Right	●	F ↗	N/A	G92NN	
		No AK	Side 2 - Right	●	F ↗	N/A	P92NN	
	Glass	No AK	Straight	●	F ↑	N/A	G02NN	
		No AK	Straight	●	F ↑	N/A	P02NN	
ICAO Runway End (RN)	Glass	No AK	Straight	●	R ↑	N/A	G43EN	
	No AK	Straight	●	R ↑	N/A	P43EN		
								With AK
FAA L-862E Runway End (RN)	Glass	No AK	Straight	●	R ↑	N/A	G42EN	

Call Out	Applications	Lens Type	Arctic Kit Selection	Main Beam Toe-In	Main Beam Color	Low Int. Omni (see note below)	For 5 step dimming curve (standard) SP.AS312-XXXXXX	"For 7 Step dimming curve SP.AS396-XXXXXX "
ICAO Runway Wingbar (RW)	Polycarbonate	Glass	With AK	Straight	● R ↑	N/A		G42EA
			No AK	Straight	● R ↑	N/A		P42EN
			With AK	Straight	● R ↑	N/A		P42EA
			No AK	Straight	● F ↑	N/A		G23CN
			With AK	Straight	● F ↑	N/A		G23CA
			No AK	Straight	● F ↑	N/A		P23CN
	Polycarbonate	Glass	With AK	Straight	● F ↑	N/A		P23CA
			No AK	Side 1 - Left	○ W ↙	○ W*		G51JN
			With AK	Side 1 - Left	○ W ↙	○ W*		G51JA
			No AK	Side 1 - Left	○ W ↙	○ W*		P51JN
			With AK	Side 1 - Left	○ W ↙	○ W*		P51JA
			No AK	Side 1 - Left	● Y ↙	● Y*		G51DN
ICAO & FAA L862 Runway Edge (RE)	Polycarbonate	Glass	With AK	Side 1 - Left	● Y ↙	● Y*		G51DA
			No AK	Side 1 - Left	● Y ↙	● Y*		P51DN
			With AK	Side 1 - Left	● Y ↙	● Y*		P51DA
			No AK	Side 1 - Left	● R ↙	● R*		G51EN
			With AK	Side 1 - Left	● R ↙	● R*		G51EA
			No AK	Side 1 - Left	● R ↙	● R*		P51EN
Polycarbonate	Glass	With AK	Side 1 - Left	● R ↙	● R*		P51EA	
		No AK	Side 2 - Right	○ W ↗	○ W*		G61JN	
		With AK	Side 2 - Right	○ W ↗	○ W*		G61JA	

Call Out	Applications	Lens Type	Arctic Kit Selection	Main Beam Toe-In	Main Beam Color	Low Int. Omni (see note below)	For 5 step dimming curve (standard) SP.AS312-XXXXXX	"For 7 Step dimming curve SP.AS396-XXXXXX "	
ICAO Stopway (SW)	ICAO Stopway (SW)	Polycarbonate	No AK	Side 2 - Right	○ W↗	○ W*		P61JN	
			With AK	Side 2 - Right	○ W↗	○ W*		P61JA	
		Glass	No AK	Side 2 - Right	● Y↗	● Y*		G61DN	
			With AK	Side 2 - Right	● Y↗	● Y*		G61DA	
		Polycarbonate	No AK	Side 2 - Right	● Y↗	● Y*		P61DN	
			With AK	Side 2 - Right	● Y↗	● Y*		P61DA	
		Glass	No AK	Side 2 - Right	● R↗	● R*		G61EN	
			With AK	Side 2 - Right	● R↗	● R*		G61EA	
		Polycarbonate	No AK	Side 2 - Right	● R↗	● R*		P61EN	
			With AK	Side 2 - Right	● R↗	● R*		P61EA	
		ICAO Stopbar Straight (SB)	Glass	No AK	Side 1 - Left	● R↖	N/A		G53EN
				With AK	Side 1 - Left	● R↖	N/A		G53EA
	Polycarbonate		No AK	Side 1 - Left	● R↖	N/A		P53EN	
			With AK	Side 1 - Left	● R↖	N/A		P53EA	
	Glass		No AK	Side 2 - Right	● R↗	N/A		G63EN	
			With AK	Side 2 - Right	● R↗	N/A		G63EA	
	Polycarbonate	No AK	Side 2 - Right	● R↗	N/A		P63EN		
		With AK	Side 2 - Right	● R↗	N/A		P63EA		
	ICAO Stopbar Straight (SB)	Glass	No AK	Straight	● R↑	N/A		G74ON	
			With AK	Straight	● R↑	N/A		G74OA	
		Polycarbonate	No AK	Straight	● R↑	N/A		P74ON	

Call Out	Applications	Lens Type	Arctic Kit Selection	Main Beam Toe-In	Main Beam Color	Low Int. Omni (see note below)	For 5 step dimming curve (standard) SP.AS312-XXXXXX	"For 7 Step dimming curve SP.AS396-XXXXXX "
ICAO Stopbar Curved (SC)	Glass		With AK	Straight	● R ↑	N/A		P740A
			No AK	Straight	● R ↑	N/A		G750N
			With AK	Straight	● R ↑	N/A		G750A
	Polycarbonate		No AK	Straight	● R ↑	N/A		P750N
			With AK	Straight	● R ↑	N/A		P750A
			No AK	Straight	● R ↑	N/A		G32AN
FAA Stopbar L-862S (SB)	Glass		With AK	Straight	● R ↑	N/A		G32AA
			No AK	Straight	● R ↑	N/A		P32AN
	Polycarbonate		No AK	Straight	● R ↑	N/A		P32AN
			With AK	Straight	● R ↑	N/A		P32AA



Note

Where omni is available it's always on the LED module. Configuration of the convertor will determine if it's on or off

7.3 Power Supply Board

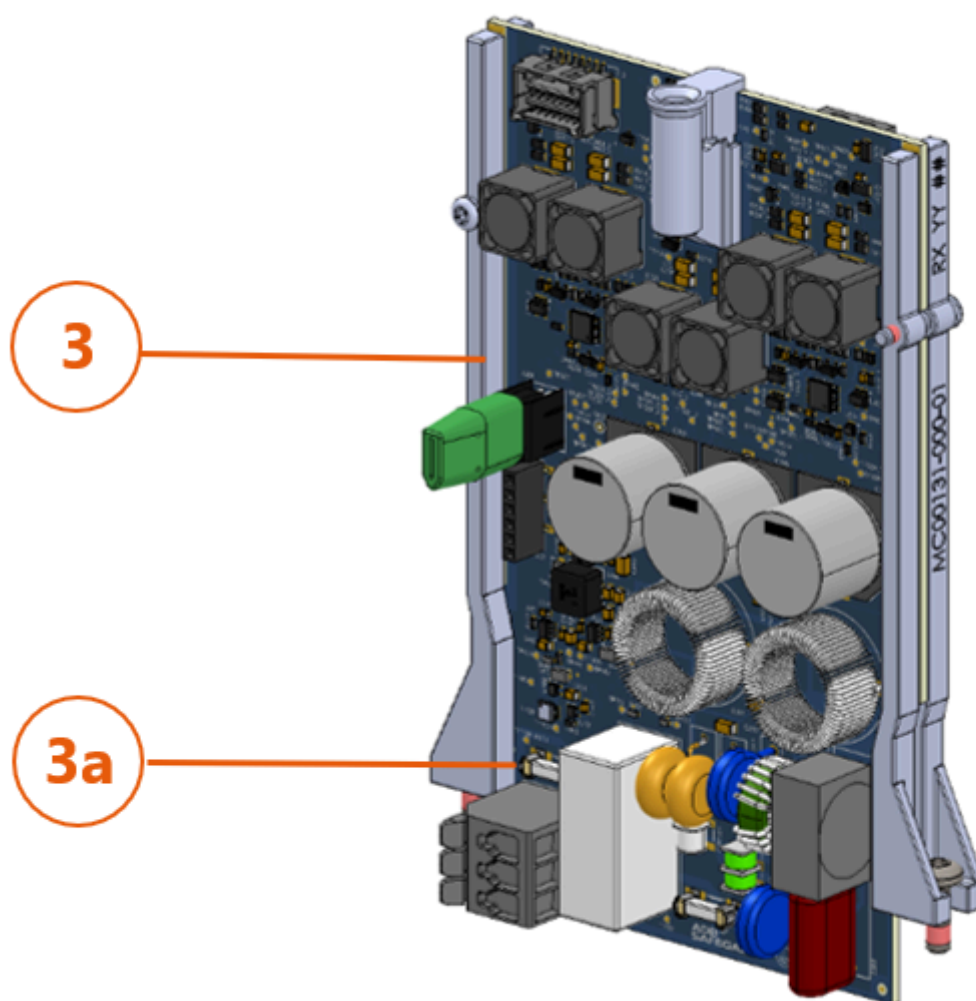

Call-Out	Description		Kit Qty	Spare Part Number
3	Non-Configured	Converter for Customer Configuration on site	1	SP.AS313-DXXX
	"Non Monitored Converter - Pre Configured Options Including necessary consumables"	Non-Monitored Converter with No Options Enabled	1	SP.AS313-SXX0
		Non-Monitored Converter Main Beam with Dimmable Omni directional	1	SP.AS313-SXX1
		Non-Monitored Converter Main Beam with Constant Intensity Omni directional	1	SP.AS313-SXX2
		Non-Monitored Converter Main Beam with Near Infra Red	1	SP.AS313-SXX3

Call-Out	Description	Kit Qty	Spare Part Number
	Non-Monitored Convertor Main Beam with Dimmable Omni directional and Near Infra Red	1	SP.AS313-SXX4
	Non-Monitored Convertor Main Beam with Constant Intensity Omni directional and Near Infra Red	1	SP.AS313-SXX5
"Fail Open Convertor – Pre Configured Options Including necessary consumables"	Fail-Open Convertor with No Options Enabled	1	SP.AS313-MXX0
	Fail-Open Convertor Main Beam with Dimmable Omni directional	1	SP.AS313-MXX1
	Fail-Open Convertor Main Beam with Constant Intensity Omni directional	1	SP.AS313-MXX2
	Fail-Open Convertor Main Beam with Near Infra Red	1	SP.AS313-MXX3
	Fail-Open Convertor Main Beam with Dimmable Omni directional and Near Infra Red	1	SP.AS313-MXX4
	Fail-Open Convertor Main Beam with Constant Intensity Omni directional and Near Infra Red	1	SP.AS313-MXX5
	3a	Replacement Fail-Open Fuse Resistor Kit	20

7.4 Tools and Accessories



Call-Out	Description	Kit Qty	Spare Part Number
15	Heater Kit - Axon Elevated	5	SP.EP00151-000
16	Lens Seal - Axon Elevated	5	SP.EP-MS00043-000
17a	Glass Lens - Axon Elevated	5	SP.MG00029-000
17b	Plastic Lens - Axon Elevated	5	SP.MG00029-001

	Description	Kit Qty	Spare Part Number
Tools	Alignment Device (Standard)	1	AK00065-STD-01
	Alignment Device (Electronic) (Available 2026)	1	AK00065-ELE-01
	Alignment Tool Calibration Kit	1	AK00066-000-01
	Convertor Programming Tool	Available 2026	
Accessories	Bird spike Kit	20	AK00060-000-01
	Elevated Snow Flag Kit	10	AK00064-000-01
	Replacement Snow Flag pole	1	SP.4072.28.650



Appendix A: Power Tables













Axon Elevated Fixture – Power Table















ATTENTION



The values below are listed for all Monitored and Non Monitored applications.











Application	Toe In	Colour			Additional function VA				
	Digit 7 Toe In	Digit 8 Side 1	Digit 9 Side 2	Base Fixture Load (VA)	SMART Arctic Kit	Circling Guidance	Infra Red	White Omni	Red Omni
AC	N - No Toe		N	34	5	N/A	3	10	8
AS	N - No Toe		N	25	5	N/A	3	9	7
SF	N - No Toe		N	25	5	N/A	3	9	7

Application	Toe In	Colour			Additional function VA				
	Digit 7 Toe In	Digit 8 Side 1	Digit 9 Side 2	Base Fixture Load (VA)	SMART Arctic Kit	Circling Guidance	Infra Red	White Omni	Red Omni
RT L-862E(L)	L - Side 1			15	10	N/A	6	N/A	N/A
RT L-862E(L)	L - Side 1		N	11	5	N/A	3	N/A	N/A
RT L-862E(L)	N - No Toe			15	10	N/A	6	N/A	N/A
RT L-862E(L)	N - No Toe		N	10	5	N/A	3	N/A	N/A
RT L-862E(L)	R - Side 2			15	10	N/A	6	N/A	N/A
RT L-862E(L)	R - Side 2	N		11	5	N/A	3	N/A	N/A
RN L-862E(L)	N - No Toe			17	10	N/A	6	N/A	N/A
RN L-862E(L)	N - No Toe		N	12	5	N/A	3	N/A	N/A

Application	Toe In	Colour			Additional function VA				
	Digit 7 Toe In	Digit 8 Side 1	Digit 9 Side 2	Base Fixture Load (VA)	SMART Arctic Kit	Circling Guidance	Infra Red	White Omni	Red Omni
RT	L - Side 1			24	10	N/A	6	N/A	N/A
RT	L - Side 1		N	19	5	N/A	3	N/A	N/A

Application	Toe In	Colour		Additional function VA					
	Digit 7 Toe In	Digit 8 Side 1	Digit 9 Side 2	Base Fixture Load (VA)	SMART Arctic Kit	Circling Guidance	Infra Red	White Omni	Red Omni
RT	N - No Toe	 F ↑	 R ↑	24	10	N/A	6	N/A	N/A
RT	N - No Toe	 F ↑	N	19	5	N/A	3	N/A	N/A
RT	R - Side 2	 R ↑	 F ↗	24	10	N/A	6	N/A	N/A
RT	R - Side 2	N	 F ↗	19	5	N/A	3	N/A	N/A
RN	N - No Toe	 R ↑	 R ↑	17	10	N/A	6	N/A	N/A
RN	N - No Toe	 R ↑	N	12	5	N/A	3	N/A	N/A
RW	N - No Toe	 F ↑	N	22	5	N/A	3	N/A	N/A

Application	Toe In	Colour		Additional function VA					
	Digit 7 Toe In	Digit 8 Side 1	Digit 9 Side 2	Base Fixture Load (VA)	SMART Arctic Kit	Circling Guidance	Infra Red	White Omni	Red Omni
SW	L - Side 1	 R ↖	N	12	5	N/A	3	N/A	N/A
SW	R - Side 2	N	 R ↗	12	5	N/A	3	N/A	N/A

Application	Toe In	Colour		Additional function VA					
	Digit 7 Toe In	Digit 8 Side 1	Digit 9 Side 2	Base Fixture Load (VA)	SMART Arctic Kit	Circling Guidance	Infra Red	White Omni	Red Omni
RE L-862(L)	C - Both Sides With Toe In	 W ↖	 W ↗	24	10	9	6	N/A	N/A
RE L-862(L)	C - Both Sides With Toe In	 W ↖	 Y ↗	21	10	9	6	N/A	N/A
RE L-862(L)	C - Both Sides With Toe In	 W ↖	 R ↗	20	10	8	6	N/A	N/A
RE L-862(L)	L - Side 1	 W ↖	N	15	5	5	3	N/A	N/A
RE L-862(L)	C - Both Sides With Toe In	 Y ↖	 W ↗	21	10	9	6	N/A	N/A
RE L-862(L)	C - Both Sides With Toe In	 Y ↖	 R ↗	18	10	8	6	N/A	N/A

Application	Toe In	Colour		Additional function VA					
	Digit 7 Toe In	Digit 8 Side 1	Digit 9 Side 2	Base Fixture Load (VA)	SMART Arctic Kit	Circling Guidance	Infra Red	White Omni	Red Omni
RE L-862(L)	L - Side 1	Y↖	N	13	5	5	3	N/A	N/A
RE L-862(L)	C - Both Sides With Toe In	R↖	W↗	20	10	8	6	N/A	N/A
RE L-862(L)	C - Both Sides With Toe In	R↖	Y↗	18	10	8	6	N/A	N/A
RE L-862(L)	C - Both Sides With Toe In	R↖	R↗	17	10	8	6	N/A	N/A
RE L-862(L)	R - Side 2	N	W↗	15	5	5	3	N/A	N/A
RE L-862(L)	R - Side 2	N	Y↗	13	5	5	3	N/A	N/A
RE L-862(L)	C - Both Sides With Toe In	F↖	W↗	18	10	9	6	N/A	N/A
RE L-862(L)	C - Both Sides With Toe In	W↖	F↗	18	10	9	6	N/A	N/A
RE L-862(L)	C - Both Sides With Toe In	Y↖	F↗	16	10	8	6	N/A	N/A
RE L-862(L)	C - Both Sides With Toe In	F↖	Y↗	16	10	8	6	N/A	N/A
SB L-862S(L)	N - No Toe	R↑	N	12	5	N/A	3	N/A	N/A

Application	Toe In	Colour		Additional function VA					
	Digit 7 Toe In	Digit 8 Side 1	Digit 9 Side 2	Base Fixture Load (VA)	SMART Arctic Kit	Circling Guidance	Infra Red	White Omni	Red Omni
SB	N - No Toe	R↑	N	11	5	N/A	3	N/A	N/A
SC	N - No Toe	R↑	N	10	5		3	N/A	N/A



Note

Non monitored & Monitored fixtures:

- The maximum rating for the isolation transformer is 150 W
- Additional voltage loss not included in the above table which must be factored into the circuit load calculation
- Primary cables will result in a higher CCR load
- Longer secondary cables may result in a larger size isolation transformer requirement
- ILCMS remotes may result in a larger size isolation transformer requirements and a higher CCR Load
- Efficiency of the isolation transformer depends on the manufacturer of the transformer

Appendix B: Alignment Guidance

Application - Regulatory	Toe In	Colour	Beam Center Requirement		Alignment Tool Setting				
	Digit 7 Toe In	Digit 8 Side 1	Digit 9 Side 2	Elevation	Toe In	Elevation Vernier Scale	Bubble Vial 'A' True Level	Bubble Vial 'B' -3.5° Offset	Toe In Vernier Scale
AC - ICAO	N - No Toe		N	5.5	0 or 2° L / R	5.5	N/A		0° or 2° L / R
				6°	0 or 2° L / R	6°			
				7°	0 or 2° L / R	7°			
				8°	0 or 2° L / R	8°			
AS - ICAO	N - No Toe		N	5.5°	2°	5.5°			2° L / R
				6°	2°	6°			
				7°	2°	7°			



Note

AC:

Approach Optical Module has built-in 3.5° mechanical elevation with 0° toe-in.

Alignment tool elevation vernier scale should be set to required elevation angle and is at the correct alignment when 'offset bubble level B' in showing level.

Toe-In should be set on the toe-in vernier scale and sighted parallel to the runway.

AS:

Approach siderow Optical Module has built-in 3.5° mechanical elevation with 0° toe-in.

Alignment tool elevation vernier scale should be set to required elevation angle and is at the correct alignment when 'offset bubble level B' in showing level.

Toe-in should be set on the toe-in vernier scale at 2° left or right and sighted parallel to the runway.

Application - Regulatory	Toe In	Colour	Beam Center Requirement		Alignment Tool Setting				
	Digit 7 Toe In	Digit 8 Side 1	Digit 9 Side 2	Elevation	Toe In	Elevation Vernier Scale	Bubble Vial 'A' True Level	Bubble Vial 'B' -3.5° Offset	Toe In Vernier Scale
RT - ICAO	L - Side 1			5.5° / 2.5°	3.5° / 0°	0°		N/A	0° or 90°
	L - Side 1		N	5.5°	3.5°				
	N - No Toe			5.5° / 2.5°	3.5° / 0°				
	N - No Toe		N	5.5°	3.5°				
	R - Side 2			2.5° / 5.5°	0° / 3.5°				
	R - Side 2	N		2.5°	3.5°				
RN - ICAO	N - No Toe			2.5° / 2.5°	0° / 0°				

Application	Toe In	Colour			Beam Center Requirement		Alignment Tool Setting			
		Digit 7 Toe In	Digit 8 Side 1	Digit 9 Side 2	Elevation	Toe In	Elevation Vernier Scale	Bubble Vial 'A' True Level	Bubble Vial 'B' -3.5° Offset	Toe In Vernier Scale
Regulatory	N - No Toe		N		2.5°	0°				
RW - ICAO	N - No Toe		N		5.5°	2°	5.5°	N/A		2° L / R



Note

RT,RN:

Threshold optical module has built-in 3.5° mechanical elevation, with additional 2° optical elevation to give a total of 5.5°. Left / right versions have built-in 3.5° optical toe-in, while straight versions have 0° toe-in.

Runway end optical module has built-in 3.5° elevation with additional -1° optical elevation to give a total elevation of 2.5°. Toe-in is at 0°.

Alignment tool elevation vernier scale should be set to 0° and is at the correct alignment when 'true level bubble A' is showing level.

Toe-in should be set on toe-in vernier scale to 0° if sighting parallel with the runway, or 90° if sighting perpendicular to the runway.

RW:

Threshold Wingbar Optical Module has built-in 3.5° mechanical elevation with 0° toe-in.

Alignment tool elevation vernier scale should be set to required elevation and is at the correct alignment when 'offset bubble level B' is showing level.

Toe-In should be set on the toe-in vernier scale at 2° left or right and sighted parallel to the runway.

Application	Toe In	Colour			Beam Center Requirement		Alignment Tool Setting			
		Digit 7 Toe In	Digit 8 Side 1	Digit 9 Side 2	Elevation	Toe In	Elevation Vernier Scale	Bubble Vial 'A' True Level	Bubble Vial 'B' -3.5° Offset	Toe In Vernier Scale
SW - ICAO 60m (ICAO 45m)	L - Side 1		N		3.5°	4.5° (3.5)	0°		N/A	0°
	R - Side 2	N								

Application	Toe In	Colour			Beam Center Requirement		Alignment Tool Setting			
		Digit 7 Toe In	Digit 8 Side 1	Digit 9 Side 2	Elevation	Toe In	Elevation Vernier Scale	Bubble Vial 'A' True Level	Bubble Vial 'B' -3.5° Offset	Toe In Vernier Scale
RE - ICAO 60m (ICAO 45m & FAA)	C - Both Sides With Toe In				3.5° / 3.5°	4.5° / 4.5° (3.5° / 3.5°)	0°		N/A	0°
	C - Both Sides With Toe In									
	C - Both Sides With Toe In									

Application	Toe In	Colour		Beam Center Requirement		Alignment Tool Setting			
		Digit 7 Toe In	Digit 8 Side 1	Digit 9 Side 2	Elevation	Toe In	Elevation Vernier Scale	Bubble Vial 'A' True Level	Bubble Vial 'B' -3.5° Offset
Regulatory	L - Side 1		N	3.5°	4.5° (3.5°)				
	C - Both Sides With Toe In			3.5° / 3.5°	4.5° / 4.5° (3.5° / 3.5°)				
	C - Both Sides With Toe In								
	L - Side 1		N	3.5°	4.5° (3.5°)				
	C - Both Sides With Toe In			3.5° / 3.5°	4.5° / 4.5° (3.5° / 3.5°)				
	C - Both Sides With Toe In								
	C - Both Sides With Toe In								
	R - Side 2	N		3.5°	4.5° (3.5°)				
	R - Side 2	N							
	RE - FAA	C - Both Sides With Toe In			5.5° / 3.5°	3.5° / 3.5°	0°		N/A
C - Both Sides With Toe In									
C - Both Sides With Toe In									
C - Both Sides With Toe In									



Note

ICAO

Runway Edge Optical module has built-in 3.5° mechanical elevation & 3.5° optical toe-in.

Alignment tool elevation vernier scale should be set to 0° and is at the correct alignment when 'true level bubble A' is showing level.

Toe-in should be set on toe-in vernier scale to 0° if sighting parallel with the runway.

The beam spread is compliant for stopway ICAO 45m and 60m with light body level and toe-in set at 0°.

The beam spread is compliant for runway edge ICAO 45m, 60m and FAA with light body level and toe-in set at 0°.

FAA:

"FAA Displaced Threshold Optical module has built-in 3.5° mechanical elevation on both sides, with additional 2° optical elevation for the threshold side to give a total of 5.5°. Both sides have 3.5° optical toe-in. Alignment tool elevation vernier scale should be set to 0° and is at the correct alignment when 'true level bubble A' is showing level. Toe-in should be set on toe-in vernier scale to 0° if sighting parallel with the runway."

Application - Regulatory	Toe In	Colour	Beam Center Requirement			Alignment Tool Setting				
			Digit 7 Toe In	Digit 8 Side 1	Digit 9 Side 2	Elevation	Toe In	Elevation Vernier Scale	Bubble Vial 'A' True Level	Bubble Vial 'B' -3.5° Offset
SB L-862S(L) - FAA	N - No Toe		N	0°	0°	0°				0°



Note

FAA stopbar Optical module has built-in 3.5° mechanical elevation 0° toe-in.

To achieve 0° optical beam center the alignment tool elevation vernier scale should be set to 0° and is at the correct alignment when 'offset bubble level B' in showing level.

Toe-on is also 0° and should be set on the toe-in vernier scale relative to sighting reference.

Application - Regulatory	Toe In	Colour	Beam Center Requirement			Alignment Tool Setting				
			Digit 7 Toe In	Digit 8 Side 1	Digit 9 Side 2	Elevation	Toe In	Elevation Vernier Scale	Bubble Vial 'A' True Level	Bubble Vial 'B' -3.5° Offset
SB - ICAO	N - No Toe		N	4.5°	0°	0°			N/A	0°
SC - ICAO	N - No Toe		N	5.5°	15.75°	0°				15.75° L /R



Note

SB:

Stopbar optical module has built-in 3.5° mechanical elevation with additional 1° optical elevation to give a total of 4.5°. Toe in is 0°.

Alignment tool elevation vernier scale should be set to 0° and is at the correct alignment when 'true level bubble A' is showing level.

Toe-in should be set on toe-in vernier scale to 0° if sighting parallel to beam direction.

SC:

Stopbar optical module has built-in 3.5° mechanical elevation with additional 2° optical elevation to give a total of 5.5°. Toe in is 0°.

Alignment tool elevation vernier scale should be set to 0° and is at the correct alignment when 'true level bubble A' is showing level.

Toe-in should be set on toe-in vernier scale at 15.75° for stopbar curved when sighting parallel to beam direction.

Appendix C: Cable Loss

The formula for measuring the cable resistance **R** (in ohms) for a single conductor is calculated with following formula:

$$R = \rho \times (L / A)$$

Where:

- **R** = resistance of the cable (in ohms, Ω)
- **ρ** = resistivity of the conductor material (in ohm-meters, $\Omega\cdot m$)
- **L** = length of the conductor (in meters, m)
- **A** = cross-sectional area of the conductor (in square meters, m^2)

Example: for 1 km of 2.5 mm² copper conductor (where the the resistivity (ρ) is 1.72 10⁻⁸ (m^2), the resistance R is calculated as follows:

$$(1.72 \cdot 10^{-8}) \times 1000 / (2.5 \cdot 10^{-6} m^2) = 6.88 \text{ ohms}$$

The loss (Watt) is then $R \times I^2$ or $6.88 \text{ ohms} \times 6.6^2 A^2 = 299.69 \text{ W/km}$ or 0.299 W/m .

The loss (Watt) for a secondary cable with 2 conductors is thus $2 \times 0.299 = 0.599$ or 0.6 W/m .

As such we can calculate:

- Secondary cable for a 2.5 mm² Cu-wire (2 conductors): 0.6 W/m
- Secondary cable for a 4 mm² Cu-wire (2 conductors): 0.4 W/m
- Primary cable for a 6 mm² Cu-wire (1 conductor): 0.12 W/m

The cable between the isolation transformer and the lamp adds losses that cannot be ignored when dimensioning the circuits and selecting rating for secondary transformers and regulators.



WARNING

Cable lengths should not exceed 100 meters.

For a secondary cable of e.g., 20 m of 2.5 mm² CU-wire, $20 \text{ m} \times 0.6 \text{ W/m} = 12 \text{ W}$ equals the additional loss to be taken into account.

For a primary cable of e.g., 100 m of 6 mm² CU-wire, $100 \text{ m} \times 0.12 \text{ W/m} = 12 \text{ W}$ equals the additional loss to be taken into account.

Appendix D: Support

Our experienced engineers are available for support and service at all times, 24 hour/7 days a week. They are part of a dynamic organization making sure the entire ADB SAFEGATE is committed to minimal disturbance for airport operations.

ADB SAFEGATE Support

Technical Support – Global

Customers in Europe, the Middle East, Africa and Asia Pacific are more than welcome to our portal for technical support. Trained in all areas of system issues, troubleshooting, quality control and technical assistance, our highly experienced Technical support specialists are available 24 hours a day, seven days a week to provide assistance over the phone.

Europe: **+32-2-722-17-11**

China: **+86-10-8476-0106**

Middle East and Africa: **+971-4-452-7575**

In the Americas, we also offer live technical support.

Live Technical Support – Americas

If at any time you have a question or concern about your product, contact ADB SAFEGATE's US-based technical support specialists, available 24 hours a day, seven days a week, to assist you via phone.

ADB SAFEGATE Americas Technical Service & Support (US & Canada) :**+1-800-545-4157**

ADB SAFEGATE Americas Technical Service & Support (Canada): **+1-905-631-1597**

ADB SAFEGATE Americas Technical Service & Support (International): **+1-614-861-1304**. For technical service press 3 and for sales support press 4.

We can also be reached via email during regular business hours.

Airfield and Gate: **techservice.us@adbsafegate.com**

Gate: **gateservice.us@adbsafegate.com**

We look forward to working with you!

Before You Call

When you have an airfield lighting or control system problem, prior to calling, please ensure the following:

- Review the product's manual and troubleshooting guide.
- Be located with the product ready to troubleshoot.
- Have all necessary information available: airport code/company name, customer id number, contact phone number/email address, product/part number.
- Have all necessary tools that may be needed at hand.

When calling about an issue with Safedock A-VDGS, we can serve you better if you collect the following information before you call:

- Relevant information regarding the issue you are calling about, such as gate number, flight number, aircraft type and time of the event.
- What, if any, actions have been taken to resolve the issue prior to the call.
- If available, provide a CCTV recording of the incident to aid in aligning the information from the Safedock log file.

For more information, see www.adbsafegate.com, contact ADB SAFEGATE Support via email at **support@adbsafegate.com**.

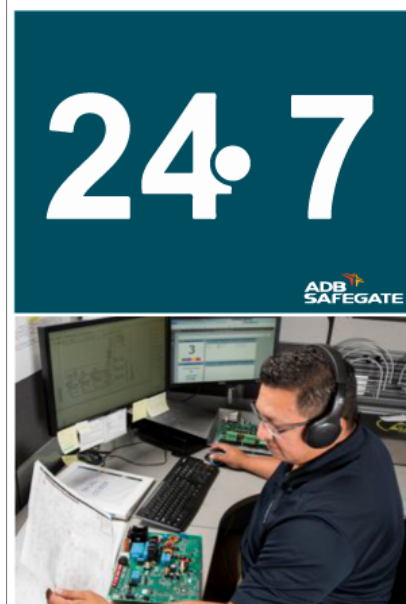

D.1 ADB SAFEGATE Website

The ADB SAFEGATE website, www.adbsafegate.com, offers information regarding our airport solutions, products, company, news, links, downloads, references, contacts and more.

Appendix E: Recycling

E.1 Local Authority Recycling

The disposal of ADB SAFEGATE products is to be made at an applicable collection point for the recycling of electrical and electronic equipment. The correct disposal of equipment prevents any potential negative consequences for the environment and human health, which could otherwise be caused by inappropriate waste handling. The recycling of materials helps to conserve natural resources. For more detailed information about recycling of products, contact your local authority city office.

E.2 ADB SAFEGATE Recycling

ADB SAFEGATE is fully committed to environmentally-conscious manufacturing with strict monitoring of our own processes as well as supplier components and sub-contractor operations. ADB SAFEGATE offers a recycling program for our products to all customers worldwide, whether or not the products were sold within the European Union (EU).

ADB SAFEGATE products and/or specific electrical and electronic component parts which are fully removed/separated from any customer equipment and returned will be accepted for our recycling program.

All items returned must be clearly labeled as follows:

- For Restriction of Hazardous Substances (*RoHS*)/Waste Electrical and Electronic Equipment (*WEEE*) Recycling
- Sender contact information (Name, Business Address, Phone number).
- Main Unit Serial Number.

ADB SAFEGATE will continue to monitor and update according for any future requirements for *EU directives* as and when *EU member states* implement new *regulations* and or *amendments*. It is our aim to maintain our *compliance plan* and assist our customers.

WWW.ADBSAFEGATE.COM

Empowering the Airside **Evolution**

SMARTER. BETTER. **NOW.**

