

Luminaire Data

Weight (luminaire)	40 lb (18 kg)
UL listing number	E338094
UL listed for USA / Canada	UL1598 CSA-C22.2 No.250.0
CE Declaration	LVD, EMC, RoHS
Ingress protection, luminaire	IP65
Impact rating	IK07
Material and finish	Aluminum, powder-coat painted
Wind speed rating (aiming only)	150 mi/h (67 m/s)
UL, IEC ambient temperature rating, luminaire	50°C (122°F)

Photometric Characteristics

Projected lumen maintenance per IES TM-21-11

L90 (20k)	>120,000 h
L80 (20k)	>120,000 h
L70 (20k)	>120,000 h
Lumens ¹	46,500
CIE correlated color temperature	5700 K
Color rendering index (CRI)	75 typ, 70 min
LED binning tolerance	7-step MacAdam Ellipse

Footnotes:

1) Incorporates appropriate dirt depreciation factor for life of luminaire.

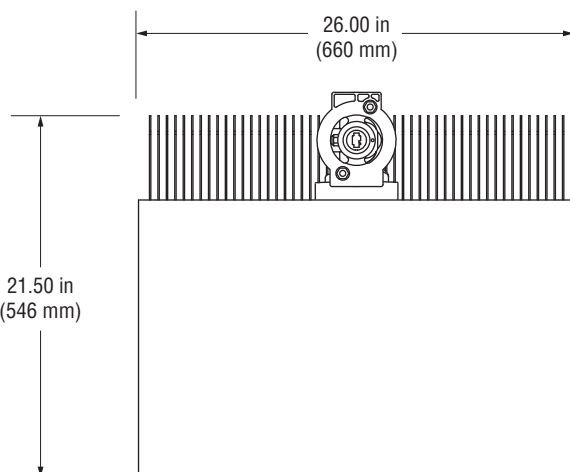
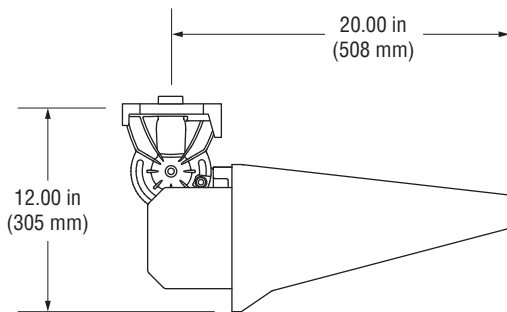
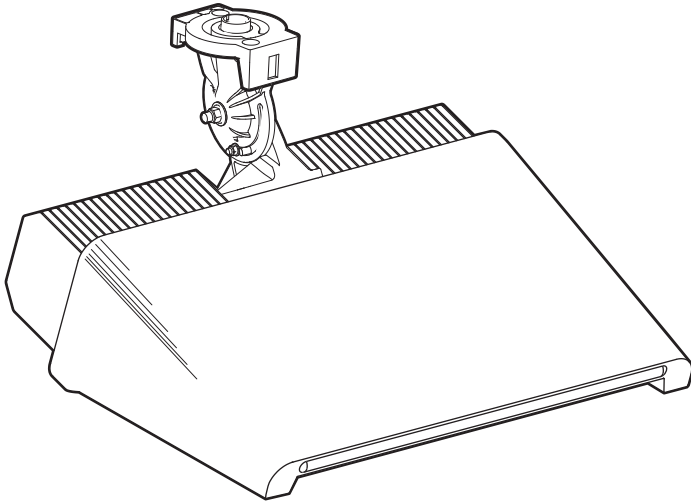

Datasheet: TLC-LED-400 Luminaire and Driver

Driver Data

Electrical Data

Rated wattage ¹	
Per driver	800 W
Per luminaire	400 W
Number of luminaires per driver	2
Starting (inrush) current	<40 A, 256 μ s
Fuse rating	15 A
UL, IEC ambient temperature rating, electrical components enclosure	50°C (122°F)
Ingress protection, electrical components enclosure	IP54
Efficiency	95%
Dimming mode	optional
Range, energy consumption	26 – 100%
Range, light output	30 – 100%
Flicker	<2%
Total harmonic distortion (THD) at full output	<20%

Typical Wiring

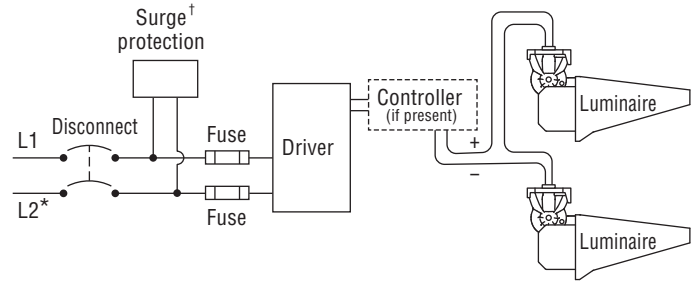

* If L2 (com) is neutral then not switched or fused.

† Not present if indoor installation.

	200 Vac 50/60 Hz	208 Vac 60 Hz	220 Vac 50/60 Hz	230 Vac 50 Hz	240 Vac 50/60 Hz	277 Vac 60 Hz	347 Vac 60 Hz	380 Vac 50/60 Hz	400 Vac 50 Hz	415 Vac 50 Hz	480 Vac 60 Hz
Max operating current per luminaire²	2.40 A	2.31 A	2.18 A	2.09 A	2.00 A	1.73 A	1.39 A	1.27 A	1.20 A	1.16 A	1.00 A

Footnotes:

- 1) Rated wattage is the power consumption, including driver efficiency losses, at stabilized operation in 25°C ambient temperature environment.
- 2) Operating current includes allowance for 0.90 minimum power factor, operating temperature, and LED light source manufacturing tolerances.

Notes

1. Use thermal magnetic HID-rated or D-curve circuit breakers.
2. See *Musco Control System Summary* for circuit information.

