



# LINC Node

IoT Gateway

## User Manual

UM-6019, Rev. v1.6.2, 2026-03-20





## A.0 Disclaimer / Standard Warranty

### CE certification

The equipment listed as CE certified means that the product complies with the essential requirements concerning safety and hygiene. The European directives that have been taken into consideration in the design are available on written request to ADB SAFEGATE.

### ETL certification

The equipment listed as ETL certified means that the product complies with the essential requirements concerning safety and C22.2 No.180:13 (R2018) regulations. The CSA directives that have been taken into consideration in the design are available on written request to ADB SAFEGATE.

### All Products Guarantee

ADB SAFEGATE will correct by repair or replacement per the applicable guarantee below, at its option, equipment or parts which fail because of mechanical, electrical or physical defects, provided that the goods have been properly handled and stored prior to installation, properly installed and properly operated after installation, and provided further that Buyer gives ADB SAFEGATE written notice of such defects after delivery of the goods to Buyer. Refer to the Safety section for more information on Material Handling Precautions and Storage precautions that must be followed.

ADB SAFEGATE reserves the right to examine goods upon which a claim is made. Said goods must be presented in the same condition as when the defect therein was discovered. ADB SAFEGATE further reserves the right to require the return of such goods to establish any claim.

ADB SAFEGATE's obligation under this guarantee is limited to making repair or replacement within a reasonable time after receipt of such written notice and does not include any other costs such as the cost of removal of defective part, installation of repaired product, labor or consequential damages of any kind, the exclusive remedy being to require such new parts to be furnished.

ADB SAFEGATE's liability under no circumstances will exceed the contract price of goods claimed to be defective. Any returns under this guarantee are to be on a transportation charges prepaid basis. For products not manufactured by, but sold by ADB SAFEGATE, warranty is limited to that extended by the original manufacturer. This is ADB SAFEGATE's sole guarantee and warranty with respect to the goods; there are no express warranties or warranties of fitness for any particular purpose or any implied warranties of fitness for any particular purpose or any implied warranties other than those made expressly herein. All such warranties being expressly disclaimed.

### Standard Products Guarantee

Products manufactured by ADB SAFEGATE are guaranteed against mechanical, electrical, and physical defects (excluding lamps) which may occur during proper and normal use for a period of two years from the date of ex-works delivery, and are guaranteed to be merchantable and fit for the ordinary purposes for which such products are made.



### Note

See your applicable sales agreement for a complete warranty description.

Replaced or repaired equipment under warranty falls into the warranty of the original delivery. No new warranty period is started for these replaced or repaired products.

### FAA Certified products manufactured by ADB SAFEGATE

ADB SAFEGATE L858 Airfield Guidance Signs are warranted against mechanical and physical defects in design or manufacture for a period of 2 years from date of installation, per FAA AC 150/5345-44 (applicable edition).

ADB SAFEGATE LED products (with the exception of obstruction lighting) are warranted against electrical defects in design or manufacture of the LED or LED specific circuitry for a period of 4 years from date of installation, per FAA EB67 (applicable edition). These FAA certified constant current (series) powered LED products must be installed, interfaced and powered with and through products certified under the FAA Airfield Lighting Equipment Program (ALECP) to be included in this 4 (four) year warranty. This includes, but is not limited to, interface with products such as Base Cans, Isolation Transformers, Connectors, Wiring, and Constant Current Regulators.



## Note

See your sales order contract for a complete warranty description.

Replaced or repaired equipment under warranty falls into the warranty of the original delivery. No new warranty period is started for these replaced or repaired products.

---

## Liability



### WARNING

Use of the equipment in ways other than described in the catalog leaflet and the manual may result in personal injury, death, or property and equipment damage. Use this equipment only as described in the manual.

ADB SAFEGATE cannot be held responsible for injuries or damages resulting from non-standard, unintended uses of its equipment. The equipment is designed and intended only for the purpose described in the manual. Uses not described in the manual are considered unintended uses and may result in serious personal injury, death or property damage.

Unintended uses, includes the following actions:

- Making changes to equipment that have not been recommended or described in this manual or using parts that are not genuine ADB SAFEGATE replacement parts or accessories.
- Failing to make sure that auxiliary equipment complies with approval agency requirements, local codes, and all applicable safety standards if not in contradiction with the general rules.
- Using materials or auxiliary equipment that are inappropriate or incompatible with your ADB SAFEGATE equipment.
- Allowing unskilled personnel to perform any task on or with the equipment.

## Copyright Statement

This manual or parts thereof may not be reproduced, stored in a retrieval system, or transmitted, in any form or by any means, electronic, mechanical, photocopying, recording, nor otherwise, without the author's prior written consent.

This manual could contain technical inaccuracies or typographical errors. The author reserves the right to revise this manual from time to time in the contents thereof without obligation of the author to notify any person of such revision or change. Details and values given in this manual are average values and have been compiled with care. They are not binding, however, and the author disclaims any liability for damages or detriments suffered as a result of reliance on the information given herein or the use of products, processes or equipment to which this manual refers. No warranty is made that the use of the information or of the products, processes or equipment to which this manual refers will not infringe any third party's patents or rights. The information given does not release the buyer from making their own experiments and tests.

# Table of Contents

<b>1.0 Safety</b> .....	<b>1</b>
1.1 Safety Messages.....	1
1.1.1 Introduction to Safety.....	2
1.1.2 Intended Use.....	2
1.1.3 Operation Safety.....	3
1.1.4 Material Handling Precautions : Storage.....	3
1.1.5 Arc Flash and Electric Shock Hazard.....	4
1.1.6 Important Notice.....	4
1.1.7 Safety and Hazards.....	4
1.1.8 Limitation of Liability.....	5
<b>2.0 Introduction</b> .....	<b>7</b>
2.1 How to work with the manual.....	7
2.2 LINC Node.....	7
2.3 Key Features.....	11
2.4 Accessories.....	12
<b>3.0 Installation and Startup</b> .....	<b>13</b>
3.1 Tools and Materials Required.....	13
3.2 Installation Overview.....	13
3.3 Step 1: Insert the SIM Card.....	13
3.4 Step 2: Mount and Ground the LINC Node Chassis.....	14
3.4.1 Flat Mount.....	15
3.4.2 Mounting on a DIN Rail.....	16
3.5 Step 3: Connect the Antenna.....	17
3.6 Startup.....	19
3.6.1 Powering up the LINC Node.....	19
3.7 Step 4: Check the LINC Node Operation.....	19
3.7.1 Ethernet LEDs.....	19
3.7.2 Reset to Factory Default Settings.....	19
3.8 Step 5: Connect to Device.....	20
3.8.1 CCR Connect.....	20
3.8.1.1 LINC Node Ethernet.....	20
3.8.1.2 LINC Node Serial.....	22
3.8.2 PAPI Connect.....	26
3.8.2.1 Installation.....	27
3.9 LINC Node Replacement.....	46
<b>4.0 Commissioning Tool and Process</b> .....	<b>49</b>
4.1 Commissioning Tool Operation.....	49
4.2 LINC Node for CCR.....	53
4.3 LINC Node for PAPI.....	59
4.4 Setting UNIT ID.....	60
<b>5.0 Specifications</b> .....	<b>63</b>
5.1 Radio Frequency Bands.....	65
5.2 Radio Module Conducted Transmit Power.....	67
5.3 Mechanical Specifications.....	69
5.4 Power Consumption.....	75
5.5 Important Information for North American Users.....	77
5.6 RF Exposure.....	77
5.7 Maximum Antenna Gain.....	78
5.8 EU.....	79
5.8.1 Declaration of Conformity.....	79
5.8.2 WEEE Notice.....	79
5.9 Notice for Brazilian Users.....	79
5.10 IMDA.....	79
<b>A.0 Support</b> .....	<b>81</b>
A.1 ADB SAFEGATE Website.....	82
A.2 ADB SAFEGATE Recycling.....	82
A.2.1 Local Authority Recycling.....	82

# List of Figures

Figure 1: LINC Node Illustration .....	7
Figure 2: LINC Node CCR Connect.....	9
Figure 3: LINC Node PAPI Connect.....	9
Figure 4: LINC Node (Ethernet variant).....	12
Figure 5: LINC Node (Serial variant) .....	12
Figure 6: Installing the SIM card .....	14
Figure 7: Mounting Bracket With Attachment Points .....	15
Figure 8: Mounting the Unit onto the Bracket .....	15
Figure 9: Mounting on a DIN Rail .....	16
Figure 10: GNSS and Cellular Antenna Connectors.....	18
Figure 11: LINC Node Power Connector.....	19
Figure 12: CCR Connect Package Content.....	20
Figure 13: Original Power Supply Cable Termination with Ferrules .....	21
Figure 14: Pinout for MCR3 (Bus A on P1 and P2, Bus B on P3 and P4) .....	23
Figure 15: Daisy-Chaining Example (1) .....	23
Figure 16: Daisy-Chaining Example (2) .....	23
Figure 17: WinCCR Software Screenshot of Bus Configuration Page.....	25
Figure 18: PAPI Connect Package Content.....	26
Figure 19: PBCA Map.....	26
Figure 20: Interface Board Assembly.....	27
Figure 21: Rail Clip Assembly (1).....	29
Figure 22: Rail Clip Assembly (2).....	30
Figure 23: Bracket Assembly on the LINC Node .....	30
Figure 24: Antenna .....	32
Figure 25: Antenna Connector.....	32
Figure 26: RELIANCE PAPI Upper View .....	33
Figure 27: Assembled View .....	34
Figure 28: Regular Installation .....	34
Figure 29: Tight Installation.....	35
Figure 30: Cables Required for PAPI Connect .....	35
Figure 31: Serial Cable Assembly.....	36
Figure 32: LINC Node Power Cable .....	38
Figure 33: FO Kit Connection .....	40
Figure 34: LINC Node Replacement .....	46
Figure 35: Application Window Main Screen - Waiting for Device Connection .....	50
Figure 36: Serial Device Dashboard View.....	51
Figure 37: Ethernet Device Dashboard View .....	51
Figure 38: Cellular Network Status and Status LED (Left Amber, Right Red ).....	52
Figure 39: Radio Settings Window.....	52
Figure 40: Assets Configuration Screen without Configured Units .....	54
Figure 41: Assets Configuration Screen with Several Configured Units .....	55
Figure 42: Device Status Indicating Presence of Unsaved Configuration.....	56
Figure 43: Export Config Option .....	57
Figure 44: Diagnostics Interface for CCR.....	58
Figure 45: Commissioning Tool Dashboard for PAPI .....	59
Figure 46: Top View .....	70
Figure 47: End Views .....	70
Figure 48: Mounting Bracket (Side View).....	71
Figure 49: Compatibility Bar.....	72

Figure 50: Mounting racket (Top View).....	73
Figure 51: Assembly .....	73
Figure 52: LINC Node on Mounting Bracket (Top, Side and End Views).....	74

## List of Tables

Table 1: Overall System Specifications .....	10
Table 2: Compliance with RF Standards.....	10
Table 3: Compatible Devices.....	10
Table 4: Key Device Specifications .....	22
Table 5: DB9 Connector Pinout Description .....	22
Table 6: J-Bus interface (Fixed) on the CRE Regulator Side.....	22
Table 7: Cellular Connectivity Status Essential Parameters .....	52
Table 8: Specifications .....	63
Table 9: LINC Node Radio Module WP8548.....	65
Table 10: LINC Node Radio Module WP7607-1 .....	65
Table 11: LINC Node Radio Module WP7702.....	65
Table 12: LINC Node Radio Module WP7611-1 .....	66
Table 13: GNSS Bands Supported .....	67
Table 14: Radio Module WP8548 Conducted Transmit Power .....	67
Table 15: Radio Module WP7607-1 Conducted Transmit Power .....	67
Table 16: Radio Module WP7702 Conducted Transmit Power .....	68
Table 17: Radio Module WP7611-1 Conducted Transmit Power .....	68
Table 18: Power Consumption – Active Mode LINC Node 3G (WP8548) .....	75
Table 19: Power Consumption – Active Mode LINC Node Cat-1 (WP7607-1) .....	75
Table 20: Power Consumption – Active Mode LINC Node Cat-1 (WP7607-1) .....	76
Table 21: Power Consumption – Active Mode LINC Node Cat-M (WP7702).....	76
Table 22: Power Consumption – Active Mode LINC Node Cat-M (WP7611-1) .....	76
Table 23: Power Consumption – Off and Ultra Low Power Modes (all LINC Node variants).....	76



# 1.0 Safety

## Introduction to Safety







This section contains general safety instructions for installing and using ADB SAFEGATE equipment. Some safety instructions may not apply to the equipment in this manual. Task- and equipment-specific warnings are included in other sections of this manual where appropriate.

## 1.1 Safety Messages


### HAZARD Icons used in this manual

For all HAZARD symbols in use, see the Safety section. All symbols must comply with ISO and ANSI standards.

Carefully read and observe all safety instructions in this manual, which alert you to safety hazards and conditions that may result in personal injury, death or property and equipment damage and are accompanied by the symbols shown below.

	<p>WARNING</p> <p>Failure to observe a warning may result in personal injury, death or equipment damage.</p>
	<p>DANGER – Risk of electrical shock or ARC FLASH</p> <p>Disconnect equipment from line voltage. Failure to observe this warning may result in personal injury, death, or equipment damage. ARC Flash may cause blindness, severe burns or death.</p>
	<p>WARNING – Wear personal protective equipment</p> <p>Failure to observe may result in serious injury.</p>
	<p>WARNING – Do not touch</p> <p>Failure to observe this warning may result in personal injury, death, or equipment damage.</p>
	<p>CAUTION</p> <p>Failure to observe a caution may result in equipment damage.</p>
	<p>ELECTROSTATIC SENSITIVE DEVICES</p> <p>This equipment may contain electrostatic devices.</p>

### Qualified Personnel

	<p><b>Important Information</b></p> <p>The term <b>qualified personnel</b> is defined here as individuals who thoroughly understand the equipment and its safe operation, maintenance and repair. Qualified personnel are physically capable of performing the required tasks, familiar with all relevant safety rules and regulations and have been trained to safely install, operate, maintain and repair the equipment. It is the responsibility of the company operating this equipment to ensure that its personnel meet these requirements.</p> <p>Always use required personal protective equipment (PPE) and follow safe electrical work practice.</p>
---	---

## 1.1.1 Introduction to Safety



### CAUTION

#### Unsafe Equipment Use

This equipment may contain electrostatic devices, hazardous voltages and sharp edges on components

- Read installation instructions in their entirety before starting installation.
- Become familiar with the general safety instructions in this section of the manual before installing, operating, maintaining or repairing this equipment.
- Read and carefully follow the instructions throughout this manual for performing specific tasks and working with specific equipment.
- Make this manual available to personnel installing, operating, maintaining or repairing this equipment.
- Follow all applicable safety procedures required by your company, industry standards and government or other regulatory agencies.
- Install all electrical connections to local code.
- Use only electrical wire of sufficient gauge and insulation to handle the rated current demand. All wiring must meet local codes.
- Route electrical wiring along a protected path. Make sure they will not be damaged by moving equipment.
- Protect components from damage, wear, and harsh environment conditions.
- Allow ample room for maintenance, panel accessibility, and cover removal.
- Protect equipment with safety devices as specified by applicable safety regulations
- If safety devices must be removed for installation, install them immediately after the work is completed and check them for proper functioning prior to returning power to the circuit.

**Failure to follow these instructions can result in serious injury, death or equipment damage**

## Additional Reference Materials



#### Important Information

- IEC – International Standards and Conformity Assessment for all electrical, electronic and related technologies.
- IEC 60364 – Electrical Installations in Buildings.
- CSA – C22.2 No.180:13 (R2018), series isolating transformers for airport lighting.
- FAA Advisory: AC 150/5340-26 (current edition), Maintenance of Airport Visual Aid Facilities.
- Maintenance personnel must refer to the maintenance procedure described in the ICAO Airport Services Manual, Part 9.
- ANSI/NFPA 79, Electrical Standards for Metalworking Machine Tools.
- National and local electrical codes and standards.

## 1.1.2 Intended Use



### CAUTION

#### Use this equipment as intended by the manufacturer

This equipment is designed to perform a specific function, do not use this equipment for other purposes

- Using this equipment in ways other than described in this manual may result in personal injury, death or property and equipment damage. Use this equipment only as described in this manual.

**Failure to follow this instruction can result in serious injury or equipment damage**

### 1.1.3 Operation Safety



#### CAUTION

##### **Improper Operation**

Do Not Operate this equipment other than as specified by the manufacturer

- Only qualified personnel, physically capable of operating the equipment and with no impairments in their judgment or reaction times, should operate this equipment.
- Read all system component manuals before operating this equipment. A thorough understanding of system components and their operation will help you operate the system safely and efficiently.
- Before starting this equipment, check all safety interlocks, fire-detection systems, and protective devices such as panels and covers. Make sure all devices are fully functional. Do not operate the system if these devices are not working properly. Do not deactivate or bypass automatic safety interlocks or locked-out electrical disconnects or pneumatic valves.
- Protect equipment with safety devices as specified by applicable safety regulations.
- If safety devices must be removed for installation, install them immediately after the work is completed and check them for proper functioning.
- Route electrical wiring along a protected path. Make sure they will not be damaged by moving equipment.
- Never operate equipment with a known malfunction.
- Do not attempt to operate or service electrical equipment if standing water is present.
- Use this equipment only in the environments for which it is rated. Do not operate this equipment in humid, flammable, or explosive environments unless it has been rated for safe operation in these environments.
- Never touch exposed electrical connections on equipment while the power is ON.

**Failure to follow these instructions can result in serious injury, death or equipment damage.**

### 1.1.4 Material Handling Precautions : Storage



#### CAUTION

##### **Improper Storage**

Store this equipment properly

- If equipment is to be stored prior to installation, it must be protected from the weather and kept free of condensation and dust.

**Failure to follow this instruction can result in equipment damage**

## 1.1.5 Arc Flash and Electric Shock Hazard



### DANGER

#### **SERIES CIRCUITS HAVE HAZARDOUS VOLTAGES**

THIS EQUIPMENT PRODUCES HIGH VOLTAGES TO MAINTAIN THE SPECIFIED CURRENT - DO NOT DISCONNECT WHILE ENERGIZED.

- ALLOW ONLY QUALIFIED PERSONNEL TO PERFORM MAINTENANCE, TROUBLESHOOTING, AND REPAIR TASKS.
- ONLY PERSONS WHO ARE PROPERLY TRAINED AND FAMILIAR WITH ADB SAFEGATE EQUIPMENT ARE PERMITTED TO SERVICE THIS EQUIPMENT.
- AN OPEN AIRFIELD CURRENT CIRCUIT IS CAPABLE OF GENERATING >5000 VAC AND MAY APPEAR OFF TO A METER.
- NEVER UNPLUG A DEVICE FROM A CONSTANT CURRENT CIRCUIT WHILE IT IS OPERATING; ARC FLASH MAY RESULT.
- DISCONNECT AND LOCK OUT ELECTRICAL POWER.
- ALWAYS USE SAFETY DEVICES WHEN WORKING ON THIS EQUIPMENT.
- FOLLOW THE RECOMMENDED MAINTENANCE PROCEDURES IN THE PRODUCT MANUALS.
- DO NOT SERVICE OR ADJUST ANY EQUIPMENT UNLESS ANOTHER PERSON TRAINED IN FIRST AID AND CPR IS PRESENT.
- CONNECT ALL DISCONNECTED EQUIPMENT GROUND CABLES AND WIRES AFTER SERVICING EQUIPMENT. GROUND ALL CONDUCTIVE EQUIPMENT.
- USE ONLY APPROVED ADB SAFEGATE REPLACEMENT PARTS. USING UNAPPROVED PARTS OR MAKING UNAPPROVED MODIFICATIONS TO EQUIPMENT MAY VOID AGENCY APPROVALS AND CREATE SAFETY HAZARDS.
- CHECK THE INTERLOCK SYSTEMS PERIODICALLY TO ENSURE THEIR EFFECTIVENESS.
- DO NOT ATTEMPT TO SERVICE ELECTRICAL EQUIPMENT IF STANDING WATER IS PRESENT. USE CAUTION WHEN SERVICING ELECTRICAL EQUIPMENT IN A HIGH-HUMIDITY ENVIRONMENT.
- USE TOOLS WITH INSULATED HANDLES WHEN WORKING WITH AIRFIELD ELECTRICAL EQUIPMENT.

**FAILURE TO FOLLOW THESE INSTRUCTIONS CAN RESULT IN DEATH OR EQUIPMENT DAMAGE**

## 1.1.6 Important Notice

Due to the nature of wireless communications, transmission and reception of data can never be guaranteed. Data may be delayed, corrupted (i.e., have errors) or be totally lost. Although significant delays or losses of data are rare when wireless devices such as the ADB SAFEGATE product are used in a normal manner with a well-constructed network, the ADB SAFEGATE product should not be used in situations where failure to transmit or receive data could result in damage of any kind to the user or any other party, including but not limited to personal injury, death, or loss of property. ADB SAFEGATE accepts no responsibility for damages of any kind resulting from delays or errors in data transmitted or received using the ADB SAFEGATE product, or for failure of the ADB SAFEGATE product to transmit or receive such data.

## 1.1.7 Safety and Hazards

Do not operate the ADB SAFEGATE product in areas where blasting is in progress, near medical equipment, near life support equipment, or any equipment which may be susceptible to any form of radio interference. In such areas, the ADB SAFEGATE product **MUST BE POWERED OFF**. The ADB SAFEGATE product can transmit signals that could interfere with this equipment.

The driver or operator of any vehicle should not operate the ADB SAFEGATE product while in control of a vehicle. Doing so will detract from the driver or operator's control and operation of that vehicle. In some jurisdictions, operating such communications devices while in control of a vehicle is an offence.

**Warning:**DO NOT USE THE USB CONNECTOR IN A HAZARDOUS AREA.

**Warning:**DO NOT USE THE RESET BUTTON IN A HAZARDOUS AREA.

This device is suitable for use in Class 1 Div 2 Groups A, B, C, and D locations. Ambient temperatures of -30C to +60C. UL Listed for use in ambient temperatures not exceeding 60C.

**Warning:**Explosion Hazard. Do not connect or disconnect while circuit is live or unless the area is known to be free of ignitable concentrations.

The device is required to be installed in a tool-secured enclosure with the appropriate type rating.

---

## 1.1.8 Limitation of Liability

**Patents** This product may contain technology developed by or for Sierra Wireless Inc. This product includes technology licensed from QUALCOMM®. This product is subject to one or more patents licensed from MMP Portfolio Licensing.

**Trademarks** ADB SAFEGATE® and LINC® are registered trademarks of ADB SAFEGATE BV.

Sierra Wireless®, Legato®, and the Sierra Wireless logo are registered trademarks of Sierra Wireless.

Windows® is a registered trademarks of Microsoft Corporation.

Linux® is the registered trademark of Linus Torvalds in the U.S. and other countries.

Macintosh® and Mac OS X® are registered trademarks of Apple Inc., registered in the United States and other countries.

QUALCOMM® is a registered trademark of QUALCOMM Incorporated. Used under license.

Other trademarks are the property of their respective owners.



## 2.0 Introduction

This document provides a manual for the installation and use of LINC Node.

**Figure 1: LINC Node Illustration**



The following chapters contain detailed information about commissioning, maintaining and replacing LINC Node.

## 2.1 How to work with the manual

1. Be familiar with the structure and content.
2. Carry out the actions completely and in the given sequence.

## 2.2 LINC Node

### Uses

LINC Node provides an interface for airports to consult intelligent AGL device information from anywhere at any time on any device with internet connectivity (tablet, mobile phone). It can be used for the following applications:

Having this information readily available on a portable device reduces the amount of time spent driving on site to collect the information that is already there. Getting immediate alerts on the smartphone in case of an operational problem reduces the response times to fix the issue.

### CCR Connect

- Insulation Resistance Monitoring and trending
- CCR Status monitoring (temperature, step, output, etc.)
- Open circuit alarms

### PAPI Connect

- Glide Angle trending and alarm
- Horizontal Angle trending and alarm
- Red/White LED alarm
- Heater fault alarm
- Temperature trending

### Customer Benefits

- Reduced personnel movement time

- Information ready at hand anytime, anywhere
- Improved maintenance cycles
- Historical trending
- Automated work orders
- Alarm notification on mobile devices via e-mail or Microsoft Teams message

## LINC Node Technology

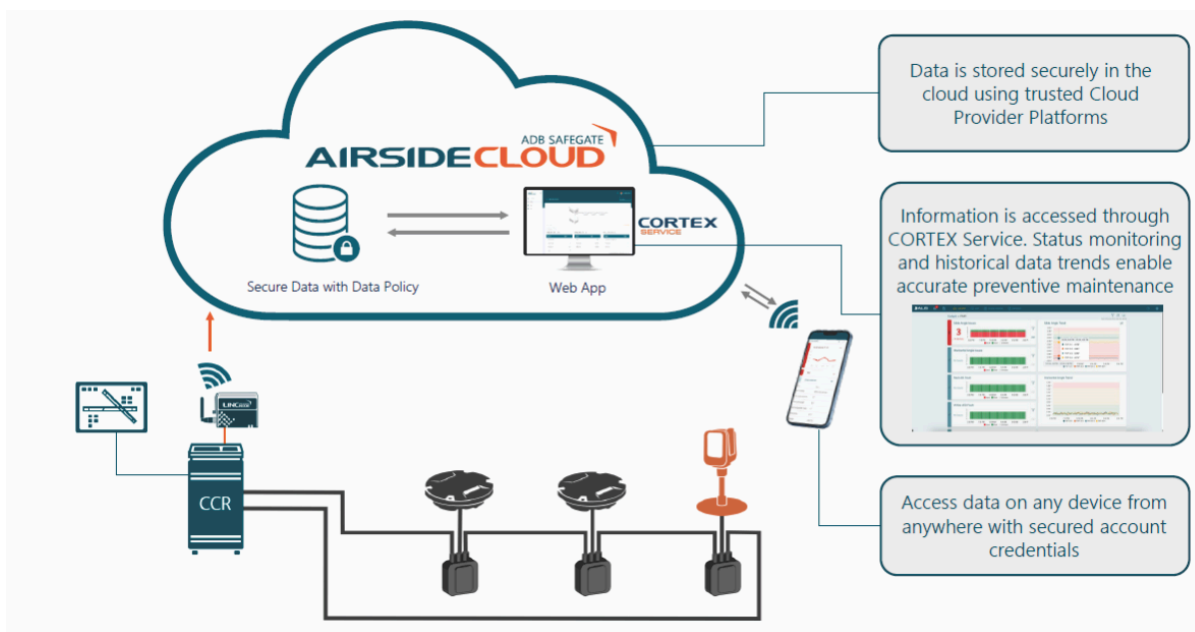
- LINC Node uses cellular technology to provide a secure and reliable connection to your AGL devices. It has a built-in intelligence capable of formatting and packaging the data that goes to the cloud. LINC Node will use a dedicated network to ensure the operational integrity of the ALCMS network and only allows for monitoring of data to prevent any intrusive attacks.
- Security of data transport is ensured with zero-touch security provisioning, secure boots and secure firmware upgrade, automated and unlimited key rotations over the air for edge-to-cloud authentication.
- LINC Node uses Low Power Wide Area (LPWA) technology (CAT-M1, NB-IOT) and GSM (2G) technology.
- Manufactured by Sierra Wireless.

## Features

- CCR variant can connect up to 16 devices
- PAPI variant connects to 1 PAPI
- ADB SAFEGATE's proven Cortex Service platform will display LINC Node's data (requires subscription)

## System Overview

**Figure 2: LINC Node CCR Connect**



**Figure 3: LINC Node PAPI Connect**



**Table 1: Overall System Specifications**

Description	Specification
<b>Operating Temperature</b>	-30 °C to +75 °C
<b>Operating Humidity</b>	Max. 96 %RH
<b>Dimensions</b>	75 x 60 x 32 mm excluding connectors;
<b>Weight</b>	158g
<b>Vibration and Shock</b>	Vibration spec: MIL-STD-810G, Method 514.6C, Category 4CWV (Composite Wheeled Vehicle); Mechanical shock spec: MIL-STD-810G, Method 516.6; Procedure I (Functional Shock)
<b>ESD</b>	8KV contact discharge, 15KV air discharge
<b>Mounting Options</b>	Bracket for screw/wall and DIN rail mounting
<b>Input Voltage</b>	4.75Vdc to 32Vdc
<b>Connections</b>	USB2.0 micro-B Ethernet variant: 10/100BASE  Serial variant: RS-485 half-duplex Maximum baud rate: 115200 bit/s Maximum cable length: 25 meters at 115200 bit/s, 40 meters at 38400 bit/s.

**Table 2: Compliance with RF Standards**

Description	Specification
<b>Air Interface</b>	LTE Cat-M1/NB1, EDGE/GSM/GPRS
<b>Frequency Bands</b>	B1, B2, B3, B4, B5, B8, B12, B13, B17, B18, B19, B20, B26, B28
<b>4G LTE</b>	
<b>3G UMTS/HSPA+</b>	-
<b>2G EDGE/GSM/GPRS</b>	850, 900, 1800, 1900
<b>Regulatory Approvals</b>	FCC/IC, CE&RoHs, REACH, RCM, Safety IEC60950 -1, UL Listed, GCF, PCTRB
<b>Radio Module</b>	WP7702



**Note**

LINC Node is delivered with a SIM card on Cellular LWPA with private APN and has a 2G back-up connection. Most countries are included but check with your Sales Representative for coverage and certification.

**Table 3: Compatible Devices**

Device Version	Serial Connection	Ethernet Connection
<b>MCR</b>	Multiwire or Dual J-bus	-
<b>CRE/VIS<sup>12</sup></b>	EPS495 Multiwire or dual JBUS (min. RCB FW 1.07 required) EP00047	EPS495 needs additional Moxa serial/ethernet adapter EP00047 (min. RCB FW 2.04 required)
<b>ASG 8000i</b>	All models	All models
<b>LED PAPI<sup>34</sup></b>	2014 & 2018 model	-

<sup>1</sup> Always check with your local Sales team for your specific CCR interface compatibility, we recommend upgrading CRE/VIS to firmware v4.32/5.22

<sup>2</sup> In case of redundant system use, one port will need to be made available for LINC Node.

<sup>3</sup> LED PAPI may need a firmware upgrade to enable additional information upload.

<sup>4</sup> LINC Node is powered by the PAPI. For continuous data connection, the PAPI needs to have current. "Black current" configuration is possible.

---

## 2.3 Key Features

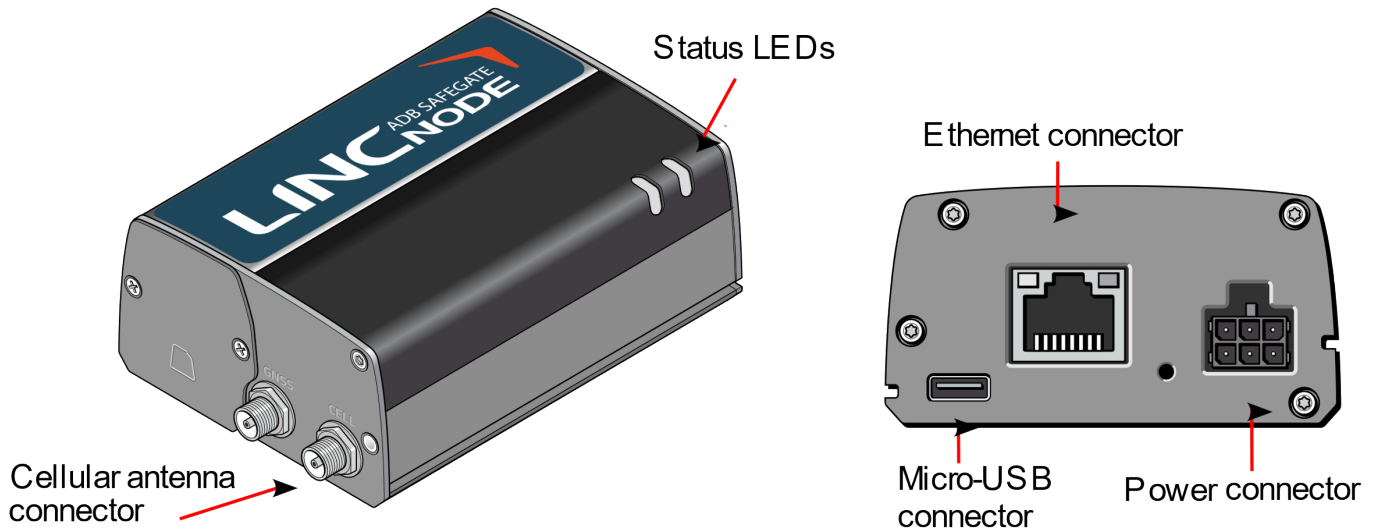
The following LINC Node variants are currently available:

- Ethernet
- Serial

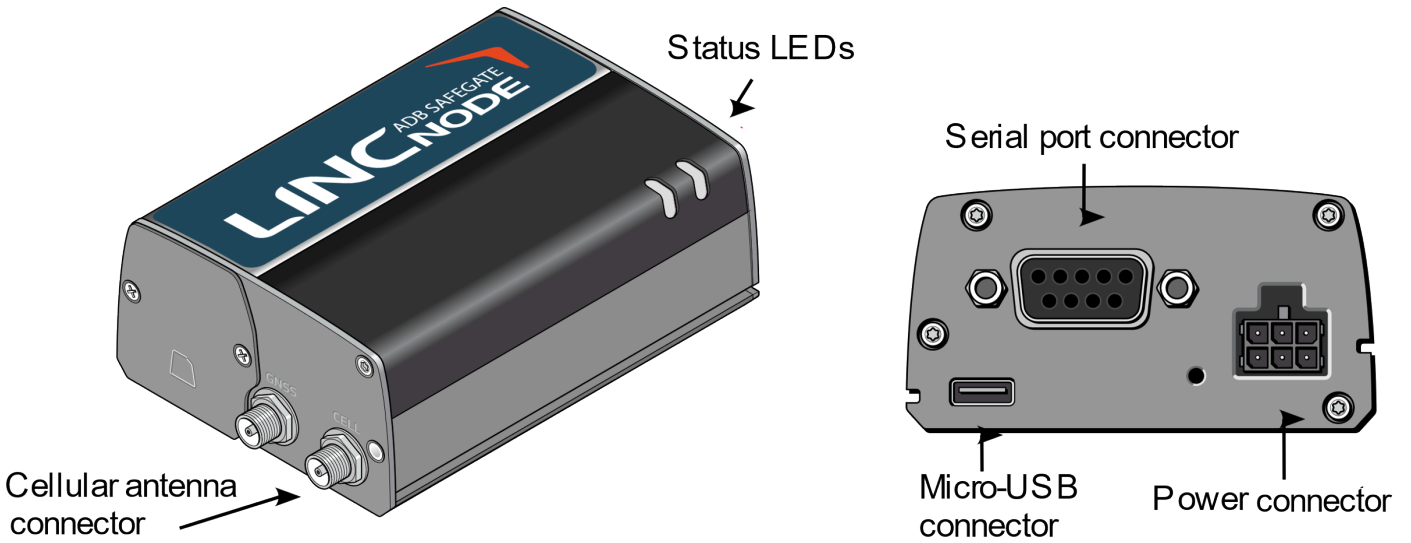
LINC Node's Key Features:

- Ethernet 10/100 Mbps
- USB 2.0
- Mini-SIM slot
- IoT expansion card slot (not used today)
- GNSS (GPS/Galileo/GLONASS/BeiDou<sup>1</sup>) (not used today)
- Linux-based Legato Embedded Application Framework
- ADB SAFEGATE All-in-One Edge-to-Cloud solution

**Figure 4: LINC Node (Ethernet variant)**



**Figure 5: LINC Node (Serial variant)**



## 2.4 Accessories

The following items come with the LINC Node gateway:

- DC power supply and cable
- Mounting bracket
- Cellular antenna
- 35mm DIN rail clips and M4 screws
- IoT Card (only for PAPI variant)
- Flatcable for 2014 PAPI Control board (only for PAPI variant)
- Flatcable for 2018 PAPI Control board (only for PAPI variant)

## 3.0 Installation and Startup

This chapter shows how to connect, install, and start the ADB SAFEGATE LINC Node. It also describes the front panel LEDs and I/O functionality.

### 3.1 Tools and Materials Required

- Mini-SIM card (provided by ADB SAFEGATE)
- #1 Philips screwdriver
- Laptop computer
- AC adapter or DC power cable
- micro-B USB cable
- Cellular antenna
- GNSS antenna (optional)

### 3.2 Installation Overview

The steps for a typical installation are:

1. [Insert the SIM card and optional IoT Expansion card.](#)
2. [Mount and ground the LINC Node.](#)
3. [Connect the antenna.](#)
4. [Check the LINC Node operation.](#)
5. [Connect to Device](#)
  - a. [CCR Connect](#)
  - b. [PAPI Connect](#)

The following sections describe these steps in detail. Read these sections carefully before performing the installation.

### 3.3 Step 1: Insert the SIM Card

The ADB SAFEGATE LINC Node has one mini-SIM (2FF) card slot and comes with one SIM card already installed.

If the SIM card has not already been installed, insert the SIM card into the gateway before connecting any external equipment or power to the LINC Node.

To install the SIM card:

1. Use a Philips screwdriver to remove the cover.
2. Orient the SIM card, as shown in the figure below. The gold contacts on the SIM card face up.
3. Gently slide the SIM card into the slot until it clicks into place.

To remove the SIM card, press it in, and release it. Gently grip the SIM card and pull it out.



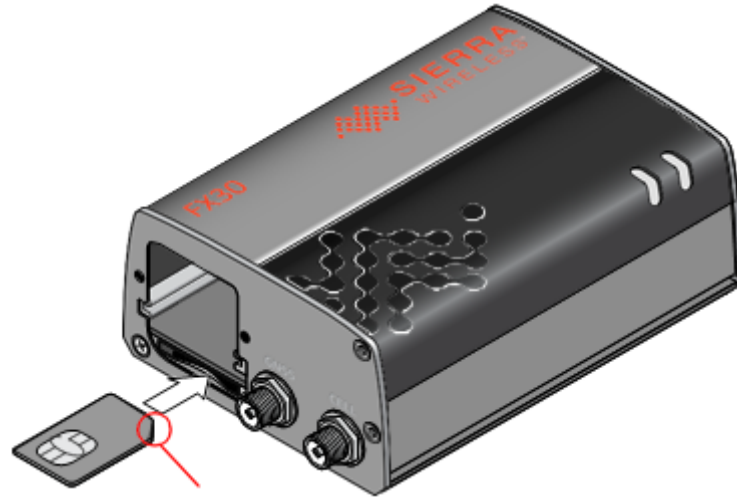
#### Note

Note the location of the notch.

---

4. Reattach the cover.

**Figure 6: Installing the SIM card**



### 3.4 Step 2: Mount and Ground the LINC Node Chassis

You can flat mount the LINC Node or mount it on a DIN rail.

Mount the LINC Node where:

- There is easy access for attaching the cables.
- Cables will not be constricted, close to high amperages, or exposed to extreme temperatures.
- The front panel LEDs are easily visible.
- There is adequate airflow.
- It is away from direct exposure to the elements such as sun, rain, dust, etc.

You can mount the LINC Node:

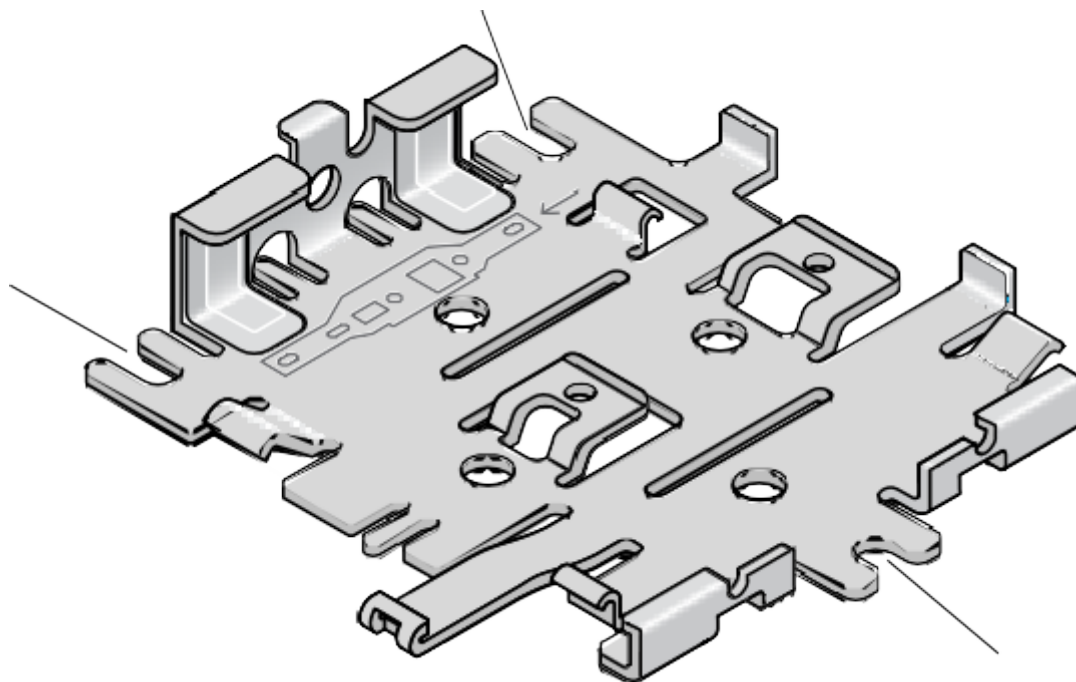
- On a [flat surface](#)
- On a [DIN Rail](#)

### 3.4.1 Flat Mount

To mount the LINC Node on a flat surface:

1. Attach the bracket to the mounting surface, using the attachment points shown in [Figure 7](#)

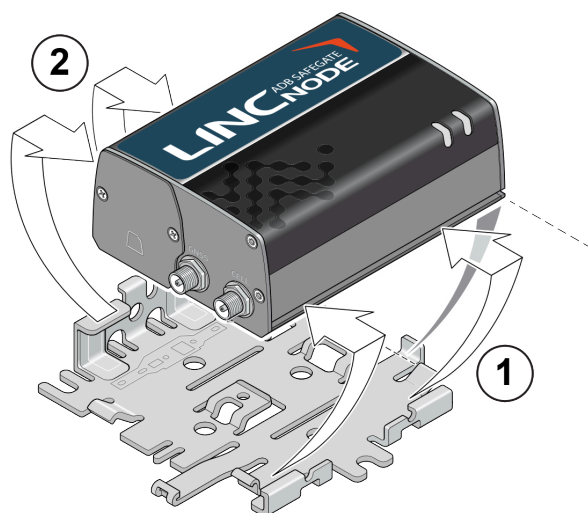
**Figure 7: Mounting Bracket With Attachment Points**



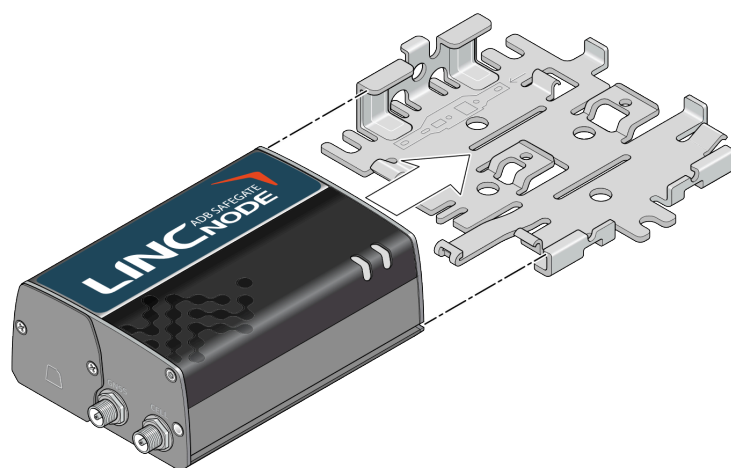
2. Snap (recommended) or, if access space is limited, slide the LINC Node onto the bracket.

**Figure 8: Mounting the Unit onto the Bracket**

Snap the unit onto the bracket



Alternatively: slide the unit onto the bracket



### 3.4.2 Mounting on a DIN Rail

To mount the LINC Node on a DIN rail:

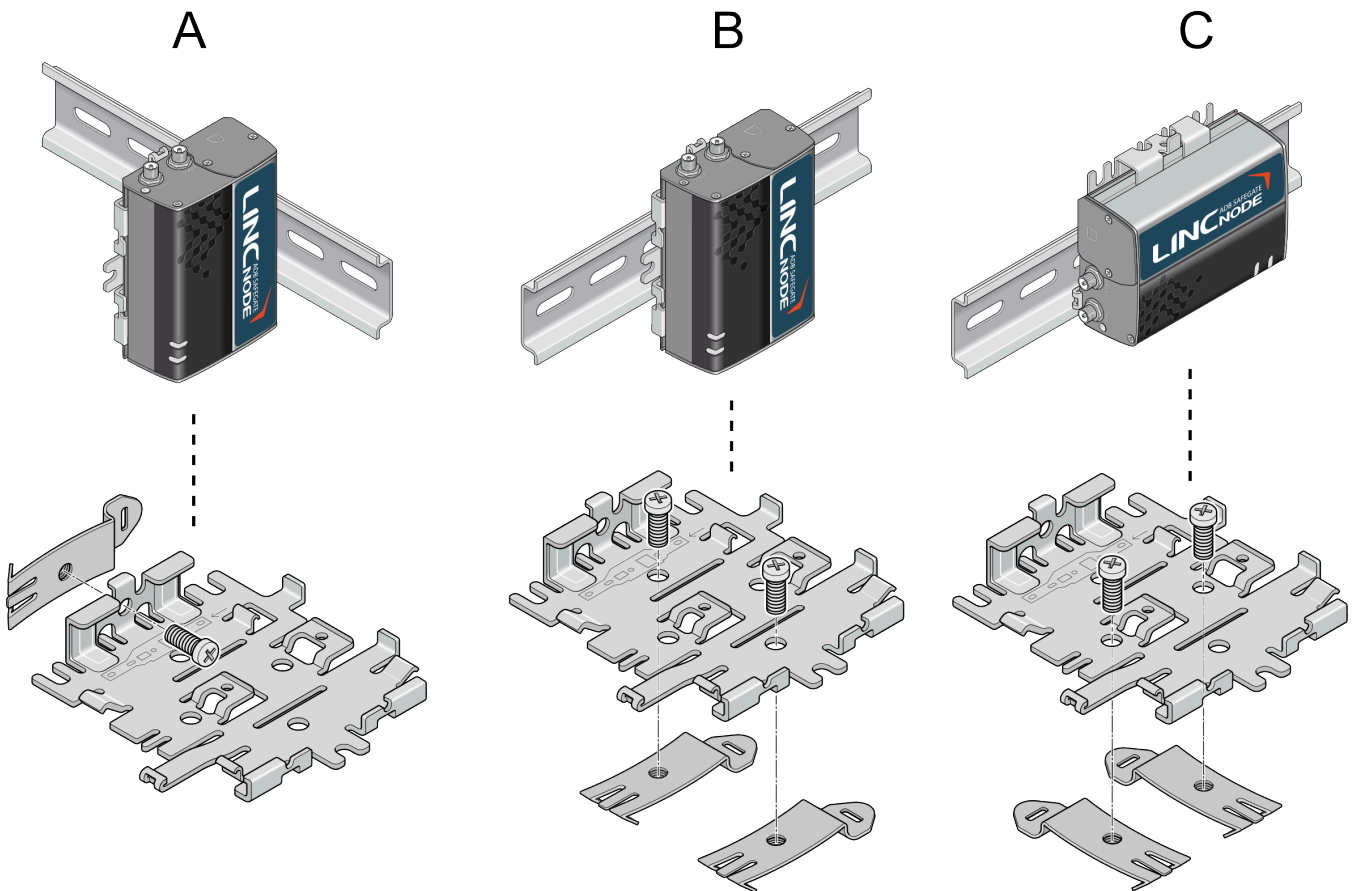
1. A. Attach the DIN rail clips to the bracket as shown in [Figure 9](#).  
B. If you are mounting the LINC Node on its edge, attach one DIN rail clip to the side of the bracket.  
C. If you are mounting the LINC Node horizontally or vertically, attach two DIN rail clips to the bottom of the bracket.



#### Note

For orientation A, attach one DIN rail clip to the side of the bracket. For orientations B and C, attach two DIN rail clips to the bottom of the bracket

Figure 9: Mounting on a DIN Rail



2. Slide or snap the LINC Node onto the bracket, as shown in [Figure 8](#).
3. Attach the LINC Node to the DIN Rail. See [Figure 9](#).

#### Earthing Connection

It is necessary and mandatory to connect the metal DIN rail to the main earthing of the location with a standard yellow 2.5mm<sup>2</sup> earth wire:



### Note

The housing body of the LINC Node is connected to the internal ground (DC)! It is recommended to use a plastic DIN rail or plastic clips for the assembly to avoid connection the GND to the earthing directly and keep these two isolated.



## 3.5 Step 3: Connect the Antenna

The LINC Node has two SMA female antenna connectors:

- Cellular antenna connector
  - GNSS antenna connector
- GNSS bias supports 3.15 V antennas



### WARNING

This gateway is not intended for use close to the human body. Antennas should be at least 8 inches (20 cm) away from the operator.

For regulatory requirements concerning antennas, see [Maximum Antenna Gain](#).

---



### Note

The antenna should not exceed the maximum gain specified in [RF Exposure](#). In more complex installations (such as those requiring long lengths of cable and/or multiple connections), you must follow the maximum dBi gain guidelines specified by the radio communications regulations of the Federal Communications Commission (FCC), Industry Canada, or your country's regulatory body

---

To install the antenna:

1. Connect the cellular antenna to the SMA cellular antenna connector.  
Mount this antenna so there is at least 20 cm between the antenna and the user or bystander.
  2. If used, connect a GNSS antenna to the SMA GNSS antenna connector. Mount the GNSS antenna where it has a good view of the sky (at least 90°).
- 



### Note

Take extra care when attaching the antennas to the SMA connectors. Finger tight (approximately 0.6–0.8 Nm 5–7 in-lb.) is sufficient and the max torque should not go beyond 1.1 Nm (10 in-lb.).

---

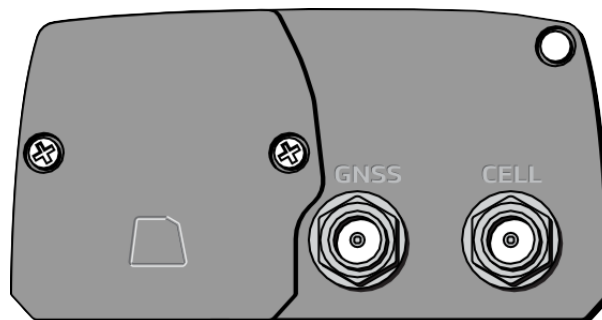


### Note

If the antennas are located away from the gateway, keep the cables as short as possible to prevent the loss of antenna gain. Route the cables so that they are protected from damage and will not be snagged or pulled on. There should be no binding or sharp corners in the cable routing. Excess cabling should be bundled and tied off. Make sure the cables are secured so their weight will not loosen the connectors from the gateway over time.

---

**Figure 10:** GNSS and Cellular Antenna Connectors



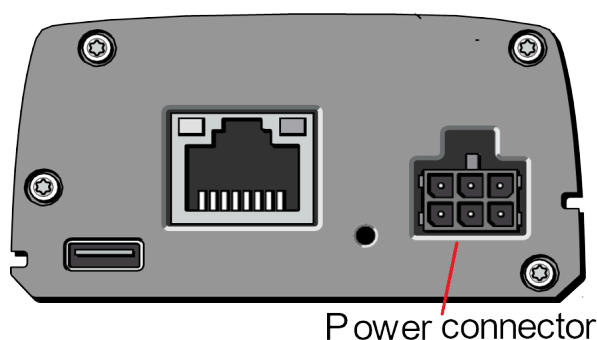
## 3.6 Startup

In this section, "LINC Node" refers to either one or multiple LINC Nodes.

### 3.6.1 Powering up the LINC Node

To power up the LINC Node, plug in the connector to the power socket.

**Figure 11:** LINC Node Power Connector



## 3.7 Step 4: Check the LINC Node Operation

On initial power up, the Power LED is red. When the processor boots up, the LED turns amber (by default). The Power LED can be controlled by Legato applications.

If the Power LED does not turn on, ensure that the:

- Power connector is plugged in and supplying voltage of 4.75 V or greater.
- On/Off (pin 3) is connected to the battery or power source.

### 3.7.1 Ethernet LEDs

The connector has two LEDs that indicate speed and activity. When looking into the connector:

- Right LED: Activity (blinking amber)
- Left LED: Connection speed (green indicates a 100 Mbps link, and off indicates no cable is connected or a 10 Mbps link is detected).

### 3.7.2 Reset to Factory Default Settings

To reset the LINC Node to the factory default settings, upon applying power, press and hold the reset button for about 10 seconds.



#### Note

Resetting the gateway to the factory default settings will remove all customized configuration settings in /etc and /data, including the root password.



#### Note

Performing a factory reset could result in your LINC Node no longer automatically connecting to AVMS. If you perform a factory reset, please issue the AT command `AT+WDSC=3,60` to ensure your device checks in to AVMS every 60 minutes.

## 3.8 Step 5: Connect to Device

### 3.8.1 CCR Connect

Both the Ethernet and the Serial variants of LINC Node can be connected with Constant Current Regulators. The following sections include instructions and limitations for each variant.



#### Note

CCR connect is currently only available on CRE and MCR3 Constant Current Regulators.

---

Figure 12: CCR Connect Package Content



#### 3.8.1.1 LINC Node Ethernet

##### Power Cable Preparation

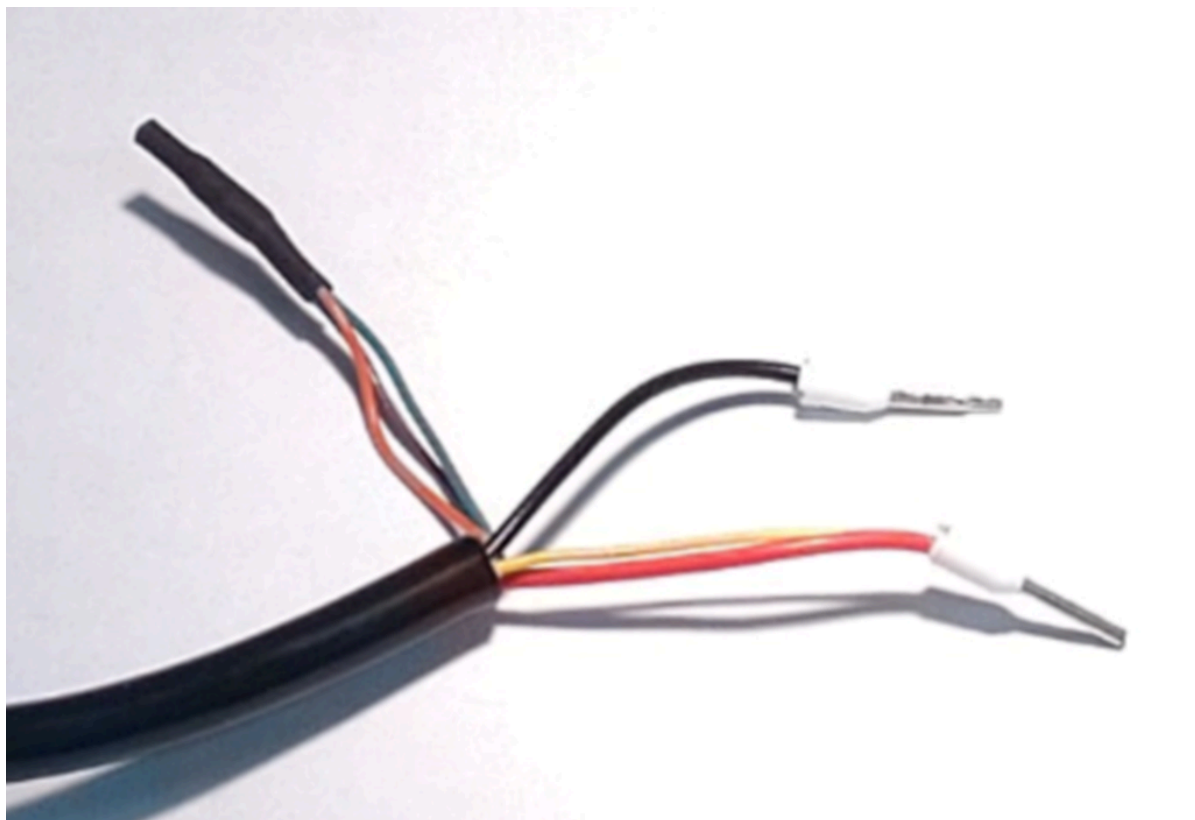
If necessary, adjust the length of the original power cable cord by cutting of unnecessary patch, such that the cable fits your final setup.

The following power cable wires must be clamped with ferrules:

- Black wire, should be connected to power supply negative potential
- Red and yellow wires should be tied together and connected to power supply positive potential.

You can cut the remaining wires in the loom or seal them carefully. The Figure below shows an example of power cable termination.

**Figure 13: Original Power Supply Cable Termination with Ferrules**



### Ethernet Interface Connection

The LINC Node Ethernet device can operate up to four MOSBUS TCP CCRs compatible with MCR2 and MCR3 protocols. The table below lists key device specifications.

Specification	Value
<b>Ethernet interface configuration</b>	<ul style="list-style-type: none"> <li>10/100 Mbps</li> <li>RJ-45 connector, use CAT5 or greater Ethernet cable</li> </ul>
<b>Supported protocols</b>	MCR2, MCR3
<b>Supported CCRs</b>	ADB SAFEGATE's CRE/VIS: <ul style="list-style-type: none"> <li>remote control board EPS495 (old remote plus moxa serial/ethernet adaptor)</li> <li>remote control board EP00047 (remote2020 with native ethernet RJ45) with RCB FW 2.04 or above</li> </ul>
<b>Power supply requirements</b>	<ul style="list-style-type: none"> <li>DC Voltage range: +5...+32V</li> <li>Power: average 2.5W, peak 7.5W</li> </ul>

Use Cat5 or greater Ethernet cable for interfacing the LINC Node to CCRs. For details on connecting the LINC Node device to the Constant Current Regulator refer to the installation manual documents for the respective CCRs.

### Required CCR Configuration (Applies to CRE/VIS)

- LINC Node must be connected to port B of the remote board in case control system is connected to port A
- CRE/VIS: "A only" control should be selected after LINC Node installation
- Modbus timeout to be raised, using remote2020 debugger tool, to 600 seconds or higher (possible for remote2020 firmware 2.04 and above).

## Limitations

- LINC Node Ethernet supports up to 16 assets. To connect more than one asset to LINC Node simultaneously, an ethernet switch is required.
- The "192.168.2.\*" subnet **is not usable** with LINC Node (reserved for commissioning tool)
- Modbus RTU over TCP protocol is not supported today
- Only non-redundant installations supported today

### 3.8.1.2 LINC Node Serial

Use twisted pair shielded cable for interfacing the LINC Node Serial device to the CCR(s). [Table] lists pinout of DB9 connector on the LINC Node Serial device. For connecting LINC Node device to the constant current regulator, refer to the installation manual documents for the respective CCRs.

**Table 4: Key Device Specifications**

Specification	Value
<b>Serial interface configuration</b>	<ul style="list-style-type: none"> <li>▪ RS-485 half-duplex (2-wire)</li> <li>▪ SW-configurable termination resistor (enabled by default)</li> <li>▪ Maximum baud rate: 115200 bit/s</li> <li>▪ Maximum cable length: 25 meters at 115200 bit/s, 40 meters at 38400 bit/s</li> </ul>
<b>Supported protocols</b>	MCR2, MCR3
<b>Supported CCRs</b>	<ul style="list-style-type: none"> <li>▪ ADB SAFEGATE MCR3: Any</li> <li>▪ ADB SAFEGATE CRE: <ul style="list-style-type: none"> <li>▪ EPSILON CS00190 (EPS495 old remote), multiwire control</li> <li>▪ EPSILON CS00190 (EPS495 old remote), dual JBUS (<b>RCB FW 1.07 and above required</b>)</li> <li>▪ ADB SAFEGATE EP0004 (remote2020)</li> </ul> </li> </ul>
<b>Power supply requirements</b>	<ul style="list-style-type: none"> <li>▪ DC Voltage range: +5...+32V</li> <li>▪ Power: average 2.5W, peak 6W</li> </ul>

Daisy-chaining of multiple regulators is made by connecting respective RS-485 interfaces in parallel. The very last unit in the net must have a termination resistor enabled.

## Serial Interface Connection

Use a twisted pair shielded cable (STP) to interface the Linc Node Serial device to the CCR(s). Connect all 3 signals (RS-485 Positive, RS-485 Negative and Ground) between the Linc Node and the regulators according to:

- [Table 5](#) shows the pinout of the DB9 connector on the Linc Node Serial device.
- [Table 6](#) shows the pinout for the connection to the 32-pole connector on the CRE.
- [Figure 14](#) shows the pinout for the connector on the MCR3 regulator.

**Table 5: DB9 Connector Pinout Description**

DB9 Pin	Description
1	RS-485 Negative Signal
2	RS-485 Positive Signal
5	Ground

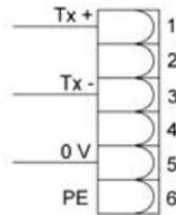
**Table 6: J-Bus interface (Fixed) on the CRE Regulator Side**

Function	Terminal number on 32-pole connector	Relay number on Remote Control PCB (unless indicated otherwise)
RS485 BusA GND	30	DB9.3
RS485 BusA Data -	32	DB9.2

**Table 6: J-Bus interface (Fixed) on the CRE Regulator Side**

Function	Terminal number on 32-pole connector	Relay number on Remote Control PCB (unless indicated otherwise)
RS485 BusA Data +	31	DB9.1
RS485 BusB GND	27	DB92.3
RS485 BusB Data +	28	DB92.2
RS485 BusB Data -	29	DB92.1

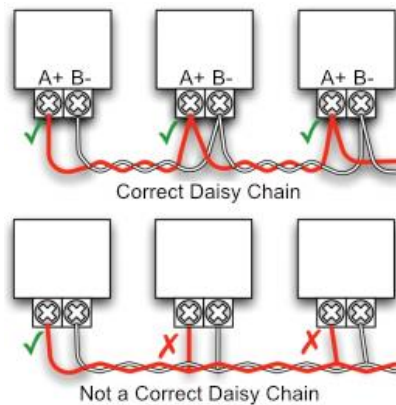
**Figure 14: Pinout for MCR3 (Bus A on P1 and P2, Bus B on P3 and P4)**



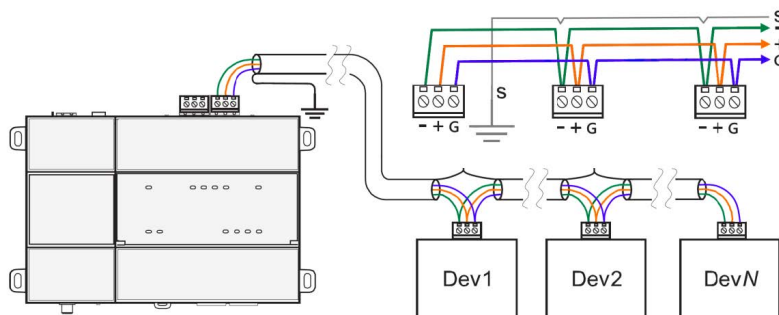
### Daisy-Chaining

Daisy-chaining of multiple regulators is achieved by connecting respective RS-485 interfaces in parallel.

**Figure 15: Daisy-Chaining Example (1)**

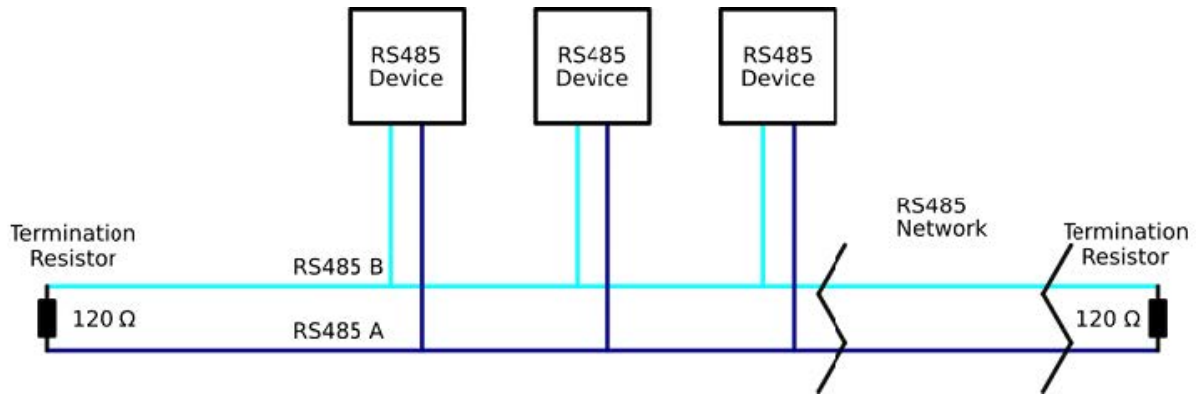


**Figure 16: Daisy-Chaining Example (2)**



- The pairs must be kept twisted for daisy chaining (as in [Figure 16](#)).

- The unshielded cable ends at the connector terminals must be minimized.
- The shielding sleeves/cover/foil must be connected to the ground ONLY on the master device side (close to the main power supply).
- Avoid routing the cables near a switching or magnetic device (fluorescent lamps, motors, pumps, motor drivers, fans etc).
- Avoid looping the bus: The bus must start at the master side and end at one of the devices.
- After daisy chaining, all the termination resistors must be removed apart from the master and the very far-end device:



- The termination resistors must be enabled on the LINC Node (via the Commissioning Tool) and the last CCR in the chain.
- Please refer to the respective CCR manuals for the location of termination jumpers.

### Required CCR Configuration

LINC Node must be connected to port B of the communication board in case control system is connected to port A.

- **For CRE/VIS CCRs:** "A only" control should be selected after LINC Node installation.
- **For MCR3:** "A control, B, monitoring" should be selected after LINC Node installation.

CRE/VIS software: remote reset should be disabled as follows:

One has to configure the unit using ADB SAFEGATE's WinCCR software to disable remote reset as shown in [Figure 17](#).

1. Run WinCCR, connect to the unit and go to **Diag/Dsp/BUS** page
2. Under **Rem Reset** press **Read** (1) to read the setting.
3. When **Rem Reset** indicates a "1", change it to "0" (2), press **Change** (3) and then **Save Configuration** (4)

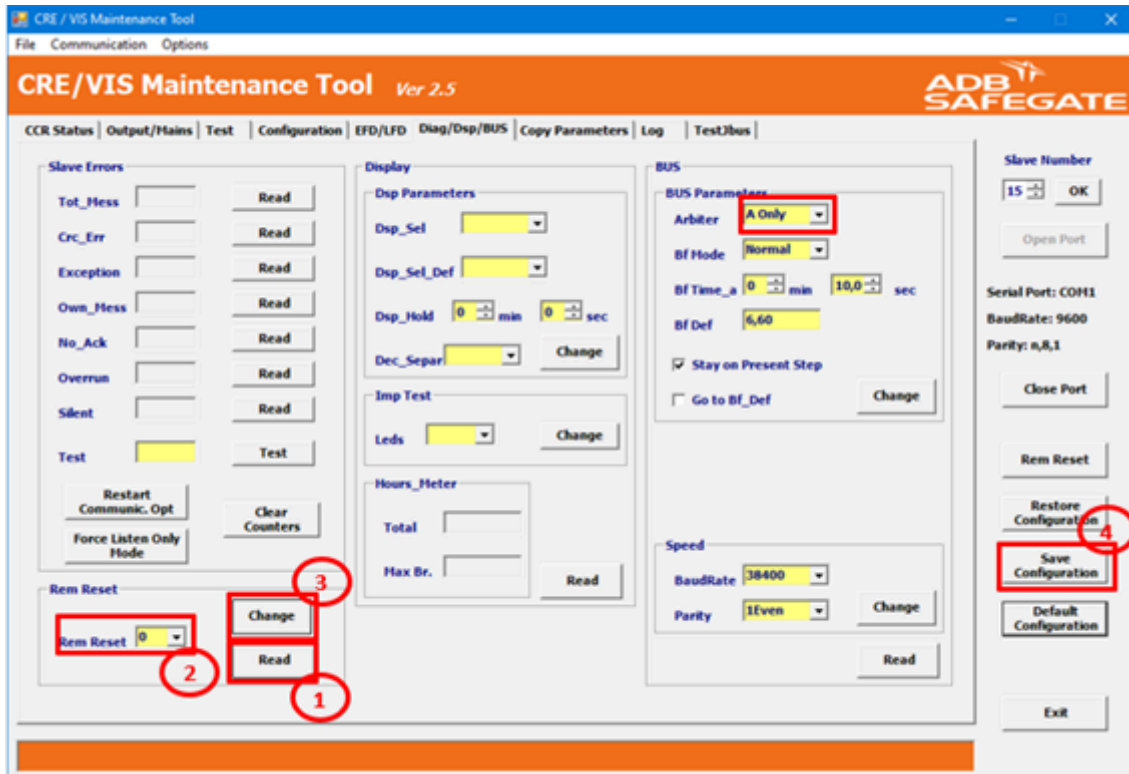


### Note

Make sure that on HMI, **Multiwire** is selected for the remote control **Menu** — "MAINT" — <password> — "MORE" — "-->" — ".,>" — REMOTE CONTROL MODE = Multiwire.

---

Figure 17: WinCCR Software Screenshot of Bus Configuration Page



### Limitations

- The LINC Node Serial device can operate up to sixteen daisy-chained MODBUS RTU CCRs compatible with MCR2 and MCR3 protocols.
- Only non-redundant installations supported today.

### 3.8.2 PAPI Connect

Here is a list of the needed equipment and tools for installing the LINC Node retrofit Kit on the PAPI:

- Reliance PAPI Light (with old or new control board, current or voltage driven version)
- A complete retrofit kit including the interface card, LINC Node, screws, cables and other accessories.
- Screw drivers (Tox #8 and 20, Philips/Pozidriv)

Figure 18: PAPI Connect Package Content

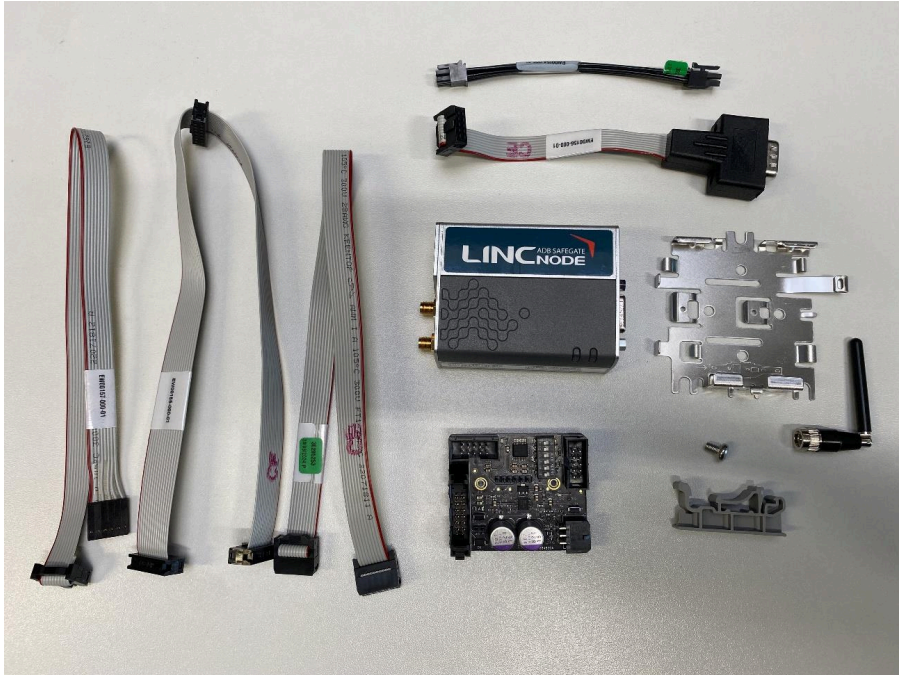
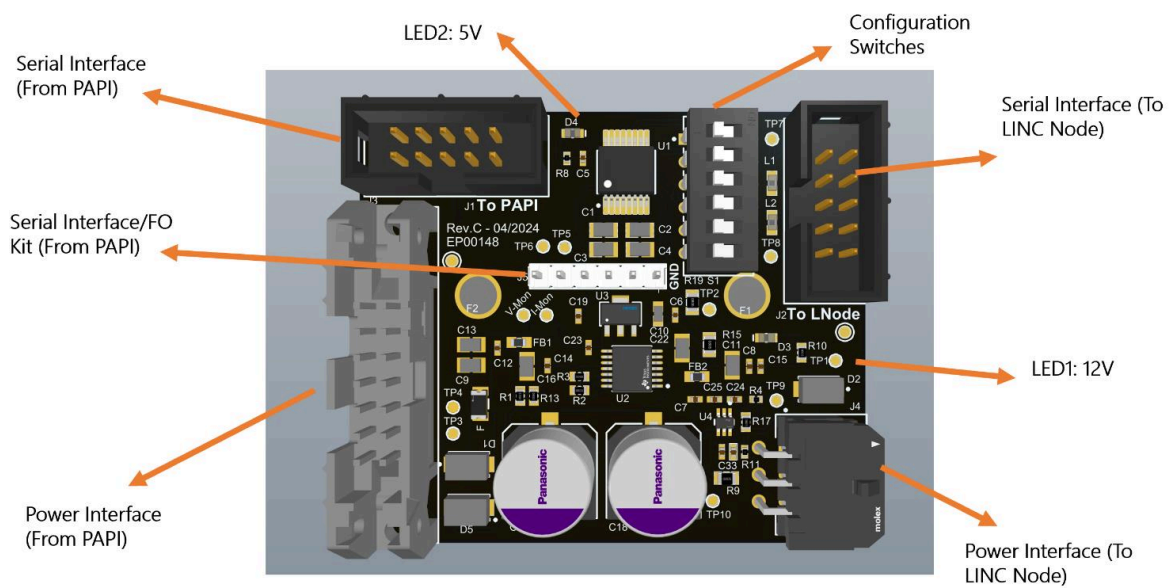


Figure 19: PBCA Map

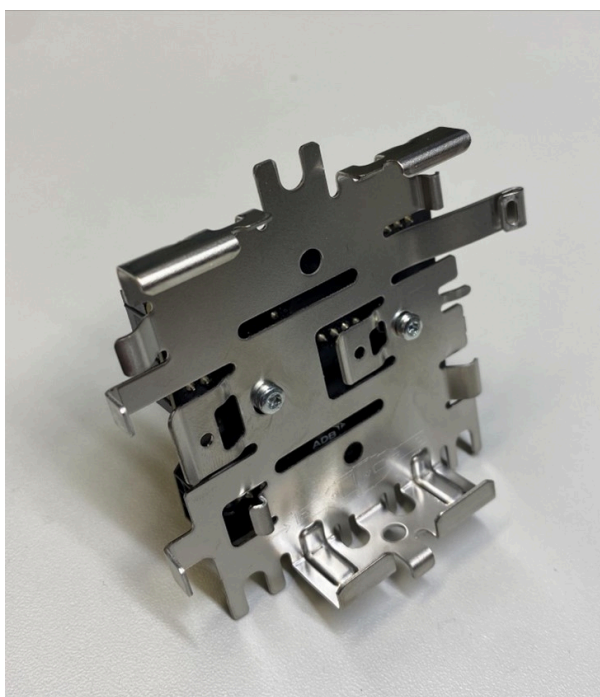
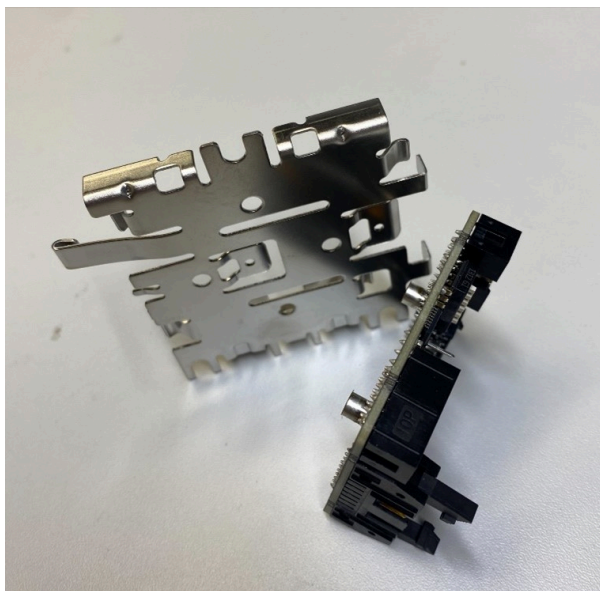


### 3.8.2.1 Installation

#### Step 1: Assembling the interface board

The interface card (IoT card) must be assembled on the bracket with 8mm screws (one pair) as shown in [Figure 20](#):

**Figure 20: Interface Board Assembly**





## ATTENTION

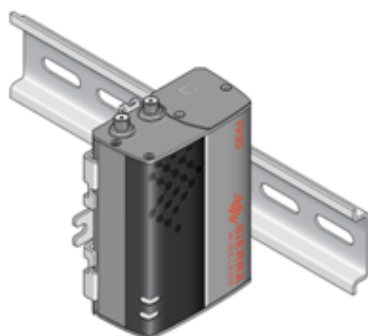
- Consider the orientation and correct placement of the board on the bracket!
  - The maximum torque for fastening the M2.5 screws is about 0.8-1 Nm, higher values can break the screw head or loosen the PCB nut.
  - Only use 8 mm screws for attaching IOT card to bracket, 9 mm screws are reserved for serial cable.
- 



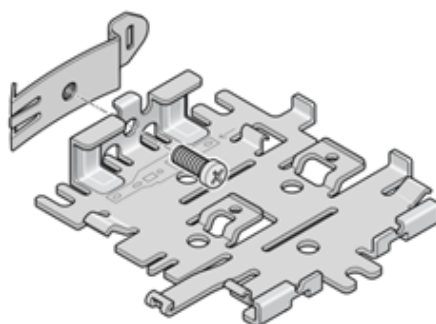
## Step 2: Assembling the rail clip

The rail clip must be assembled on the bracket with the available screw as shown in the picture below

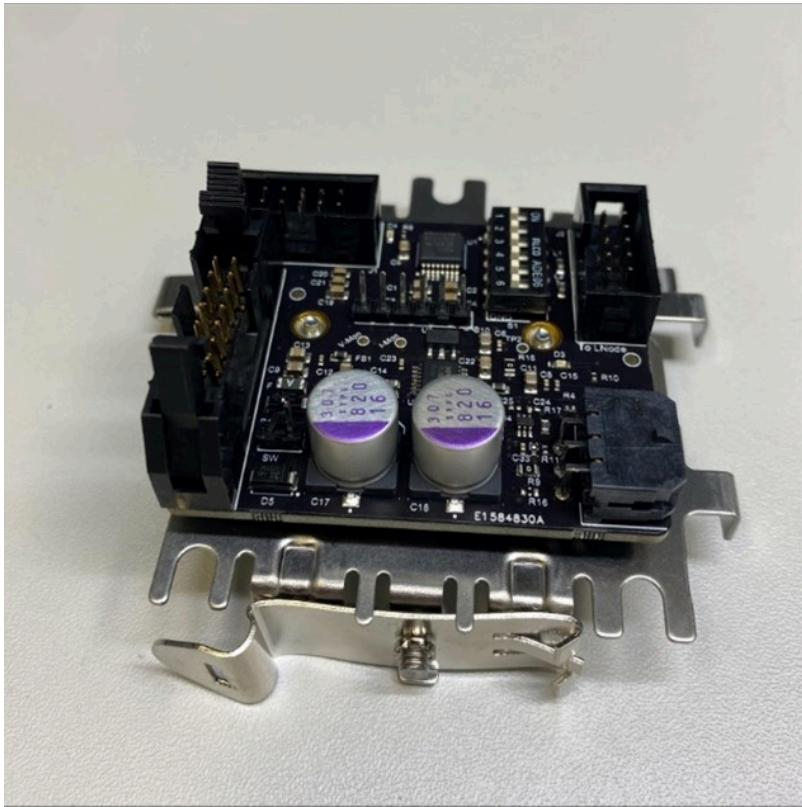
**Figure 21: Rail Clip Assembly (1)**



*For this orientation, attach one DIN rail clip to the side of the bracket.*



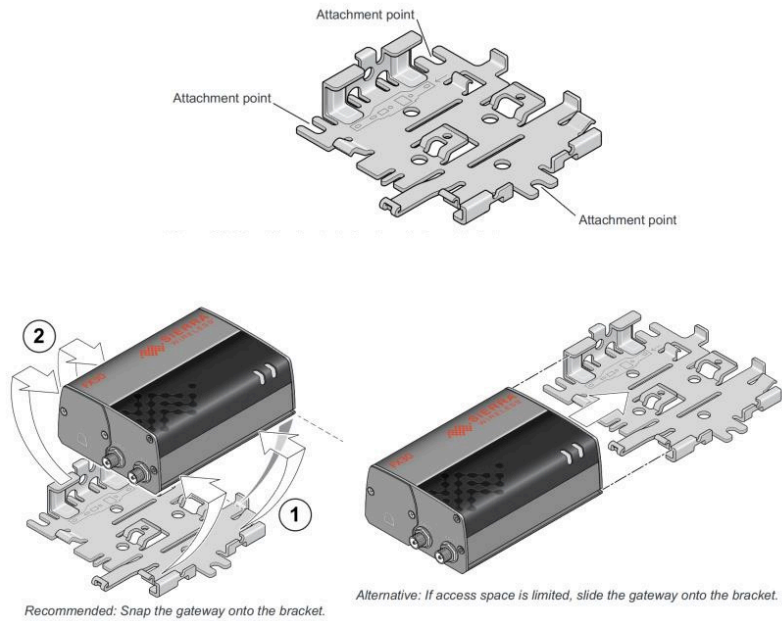
**Figure 22: Rail Clip Assembly (2)**

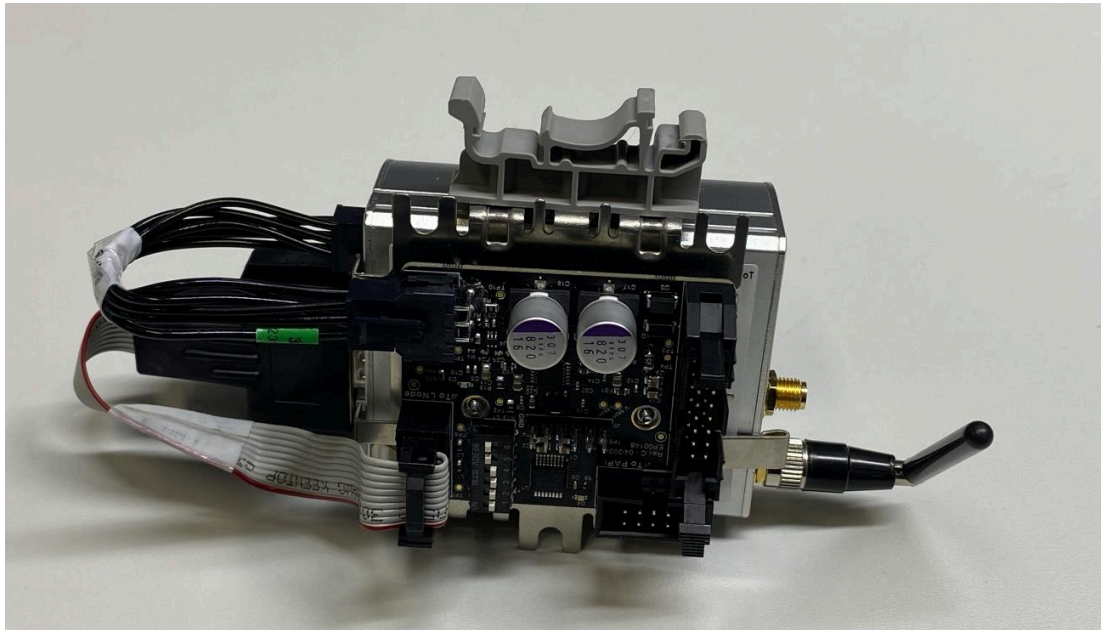


**Step 3: Assembling the bracket on the LINC Node**

Attach the bracket to the mounting surface, using the attachment points shown below:

**Figure 23: Bracket Assembly on the LINC Node**





#### Step 4: Configuring the DIP Switches

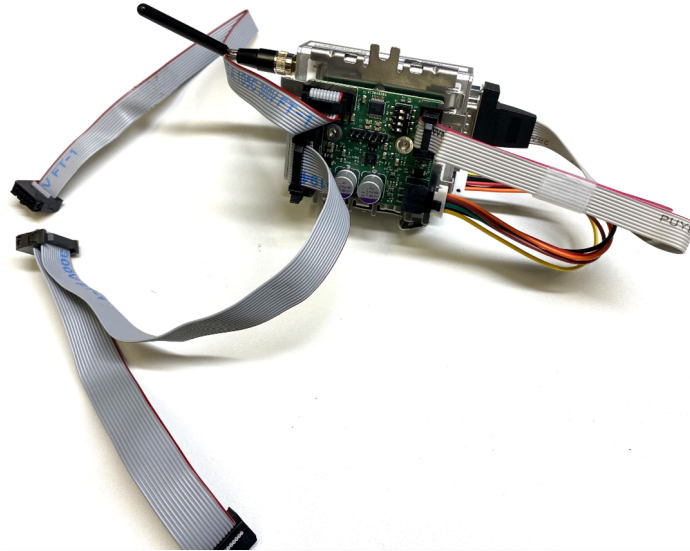
To support both PAPI control board versions, the serial interface mode can be selected with a 6-position DIP switch. Check the control board version and configure the switches as shown in the table below:

Switch #	Old Control Board	New Control Board
1	OFF	ON
2	OFF	ON
3	OFF	ON
4	OFF	ON
5	ON	OFF
6	ON	OFF



#### Note

The other combinations of DIP switch states can lead to an unknown/non-functional interface.



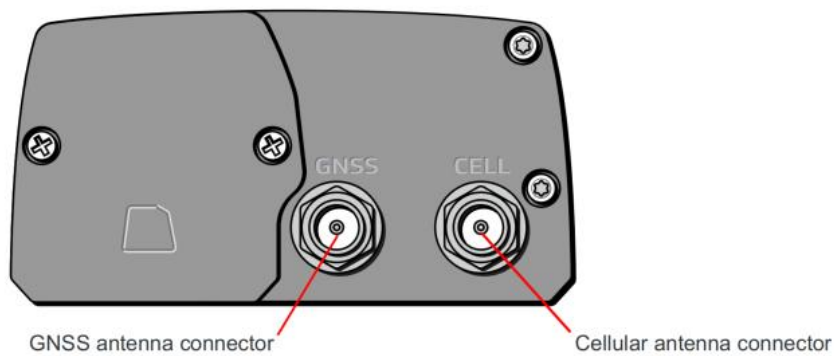
### Step 5: Mounting the Antenna

Install the cellular antenna in the correct antenna SMA socket as shown in the picture:

**Figure 24:** Antenna



**Figure 25:** Antenna Connector





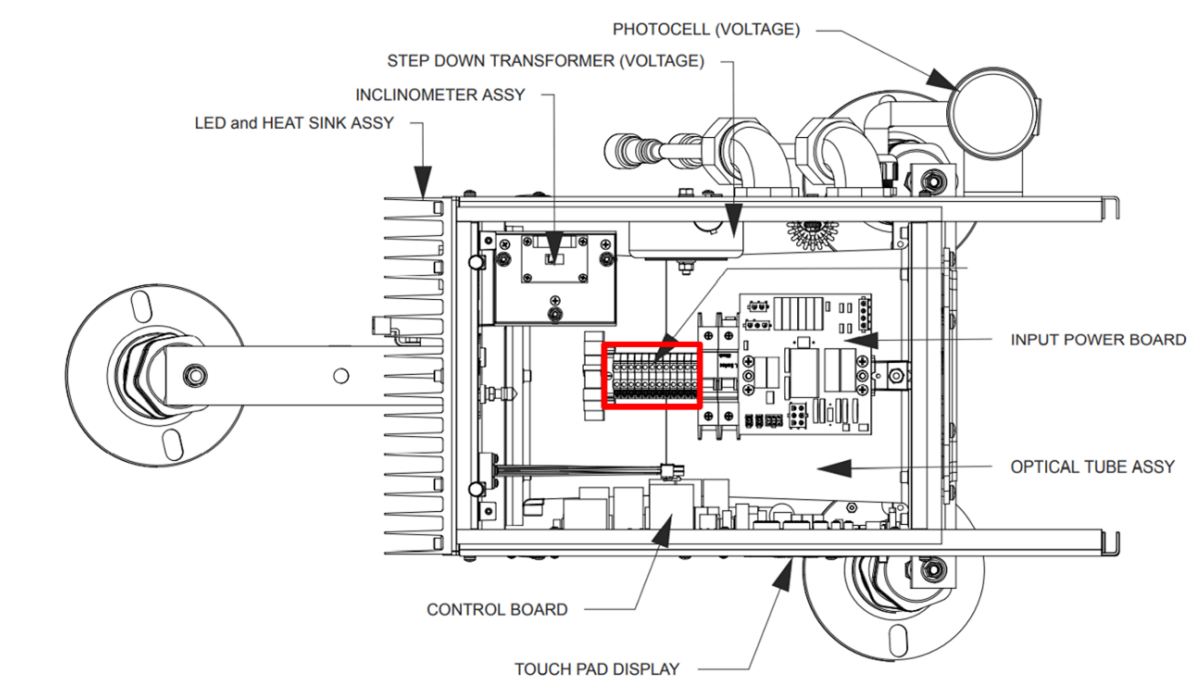
## IMPORTANT

Take extra care when attaching the antennas to the SMA connectors. Finger tight (approximately 0.6–0.8 Nm 5–7 in-lb.) is sufficient and the max torque should not go beyond 1.1 Nm (10 in-lb.).

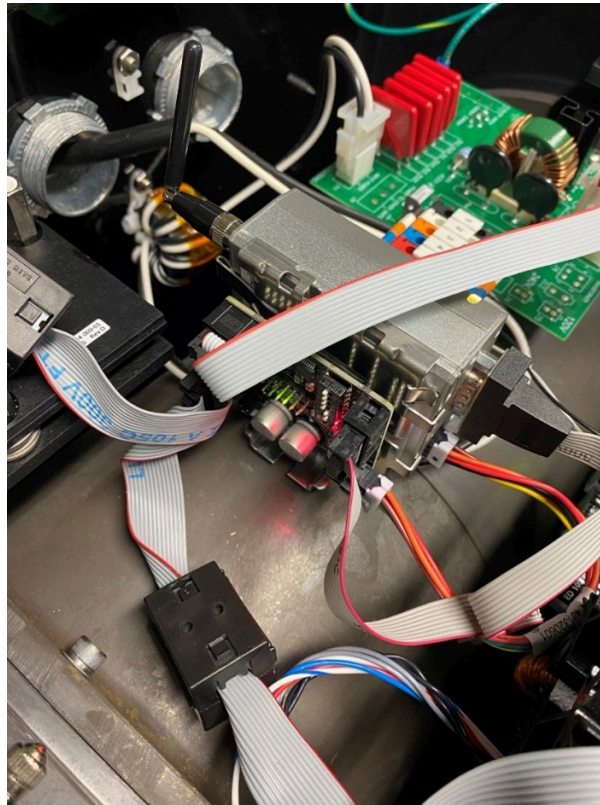
### Step 6: Assembling the Unit on the DIN Rail of PAPI

The installation location of the LINC Node inside the PAPI is shown in the picture below:

**Figure 26: RELIANCE PAPI Upper View**



**Figure 27: Assembled View**

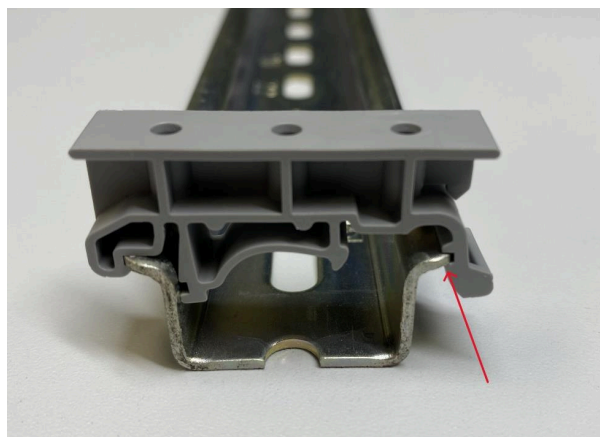


**Note**

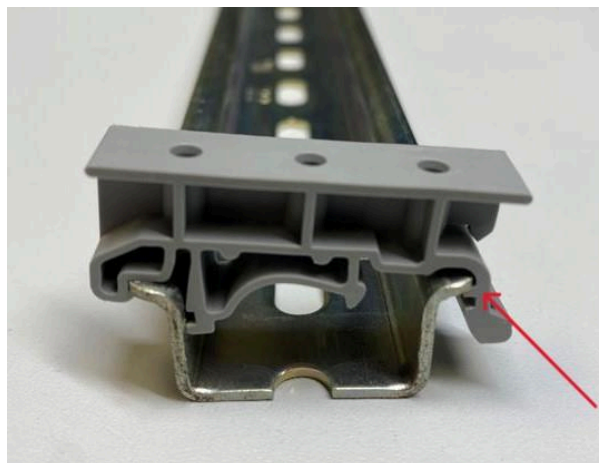
The DIN rail clip can be installed more tightly by pushing it into the lower step of the clip if the LINC Node assembly does not secure tight enough on the DIN rail.

---

**Figure 28: Regular Installation**



**Figure 29: Tight Installation**



**Step 7: Connecting the Cables**

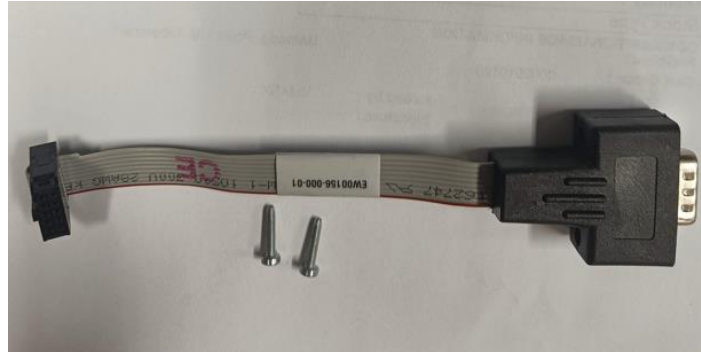
There are 4 pieces of the cable to connect to the unit. Before connecting any cables, make sure that the PAPI system is off and discharged or unplugged. The Figure below shows (from left) the serial cables for the new control board (up) and the old control board (down), the LINC Node power cable, the LINC Node serial cable (board to LINC Node) and the IDC power cable (PAPI to board and inclinometer).

**Figure 30: Cables Required for PAPI Connect**



### A) Connect the Serial Interface cable (From board to LINC Node)

Figure 31: Serial Cable Assembly



#### Note

To connect the serial DB9 connector, the existing standoff nuts must be removed.

---

Attach the DB9 connector with the available 9 mm screws to the female connector of the LINC Node.

---



#### CAUTION

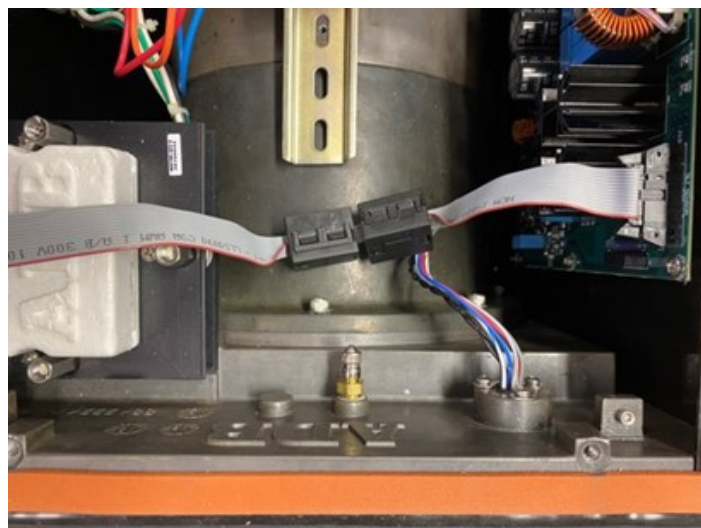
Double-check the 10-pin black box connector. There are two similar receptacles on board. This cable must be connected to the one with the text: "TO LINC Node"

---

### B) Connect the Power IDC cable (From PAPI to the board)

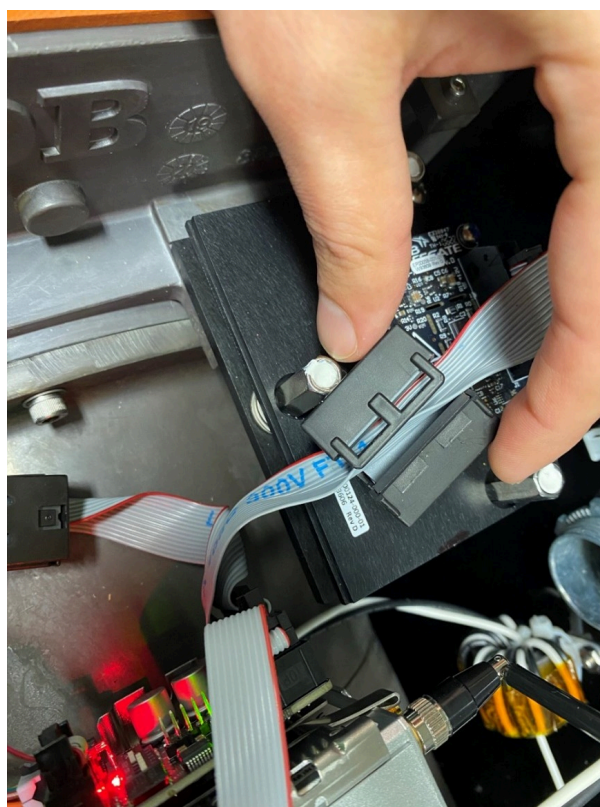
The control board sources the power of the card and eventually LINC Node through the inclinometer IDC cable. Normally, PAPI has an IDC cable between the control board and the inclinometer (small white isolated box). This cable must be replaced with the new cable to enable it to power up the card.





**IMPORTANT**

The ferrite clamps must be mounted on the new cable after replacing the cables.



### **C) Connect the Power Cable (To LINC Node)**

**Figure 32:** LINC Node Power Cable



#### **Note**

If the connector plugged correctly, you should listen or feel the clicking sound of the locking mechanism of the connector.

---

### **D) Connect the Serial Cable (From board to PAPI)**

**Version 1:** Only for the new PAPI Control Board (2018)

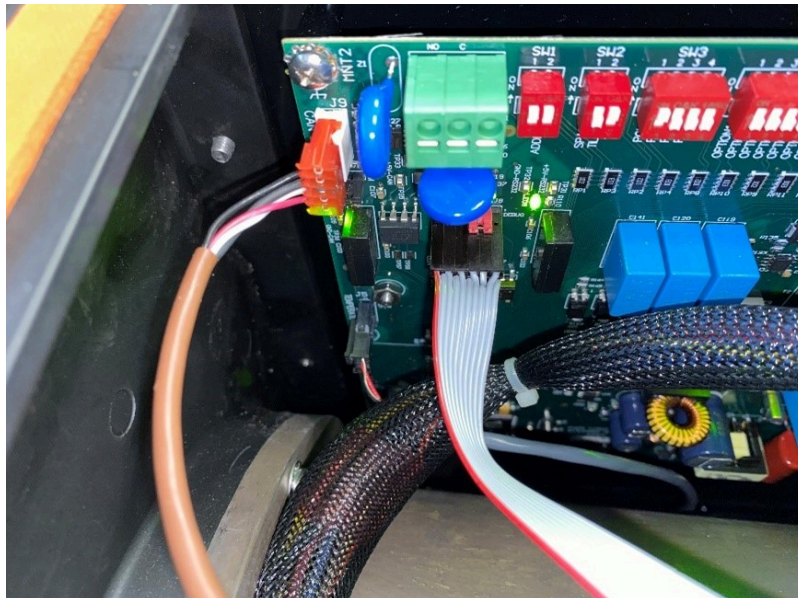
---



#### **CAUTION**

Inserting the single-row header on PAPI control board is prone to mistake! The orientation of the connector (red-wire side) must be as shown in Figure.

---

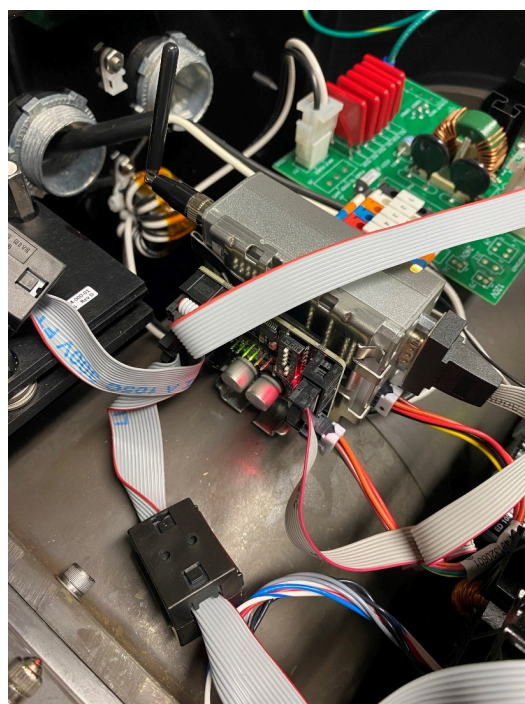
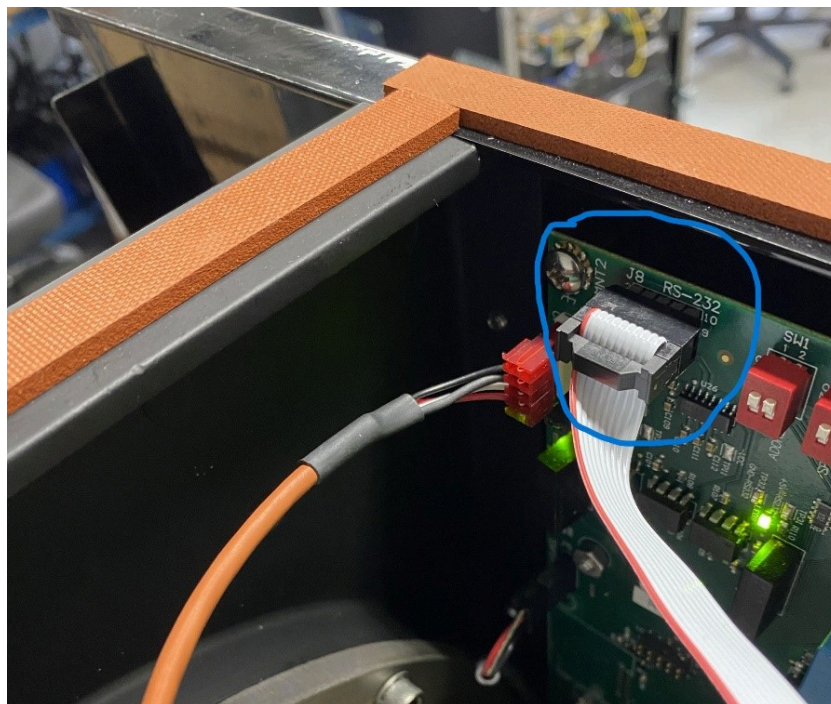


**Version 2:** Only for the old PAPI Control Board (2014)



**CAUTION**

The orientation of pin 1 (red-wire side) must be as shown in Figure.



## E) Connect the Fail-Open Kit

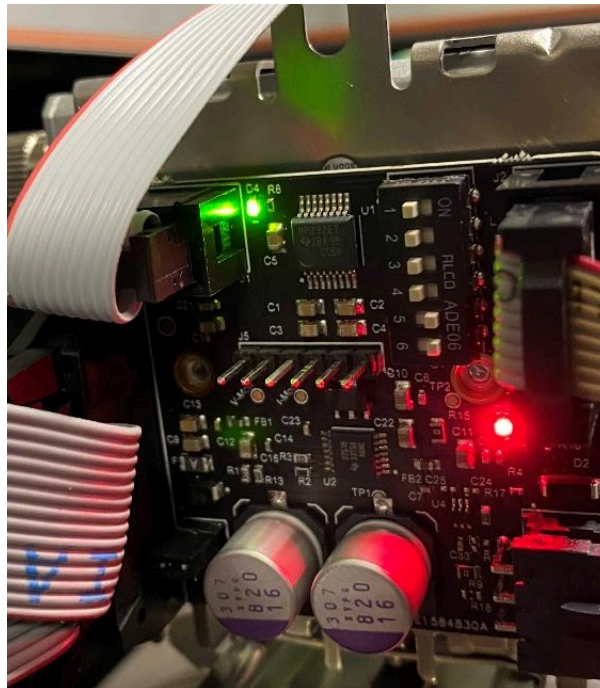
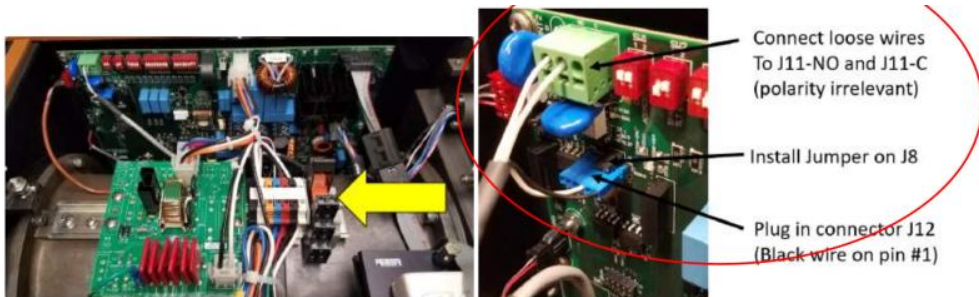


### Note

The optional Fail-Open feature is provided with the light unit when specified (see ordering codes). Available with the Current Powered non-redundant system only. Installed on the primary light unit only.

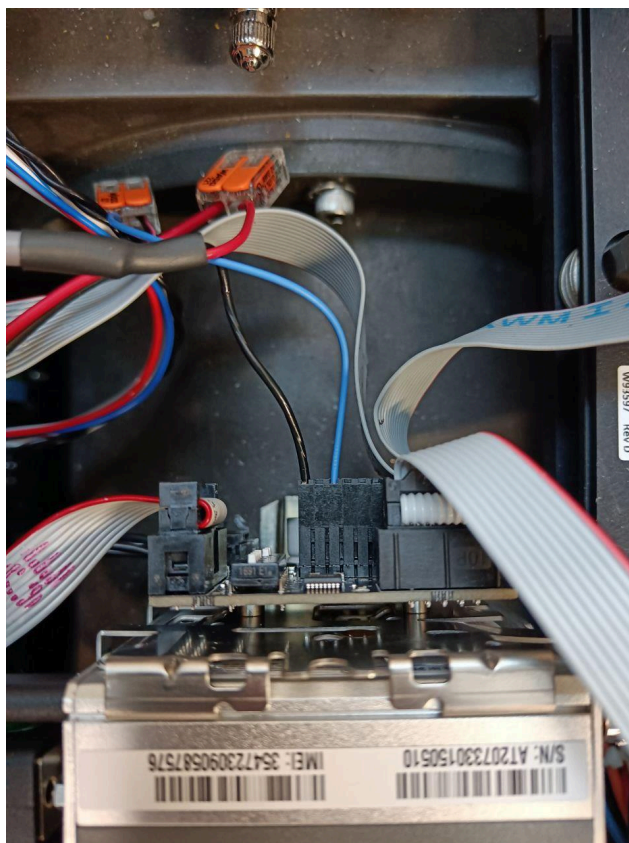
The Fail-Open (FO) kit can be connected to the PAPI in the same way instructed in the Fail-open document, but since the LINC Node serial connector already occupies the J8 connector, the FO kit can be connected to the available pin headers on the interface board:

**Figure 33: FO Kit Connection**

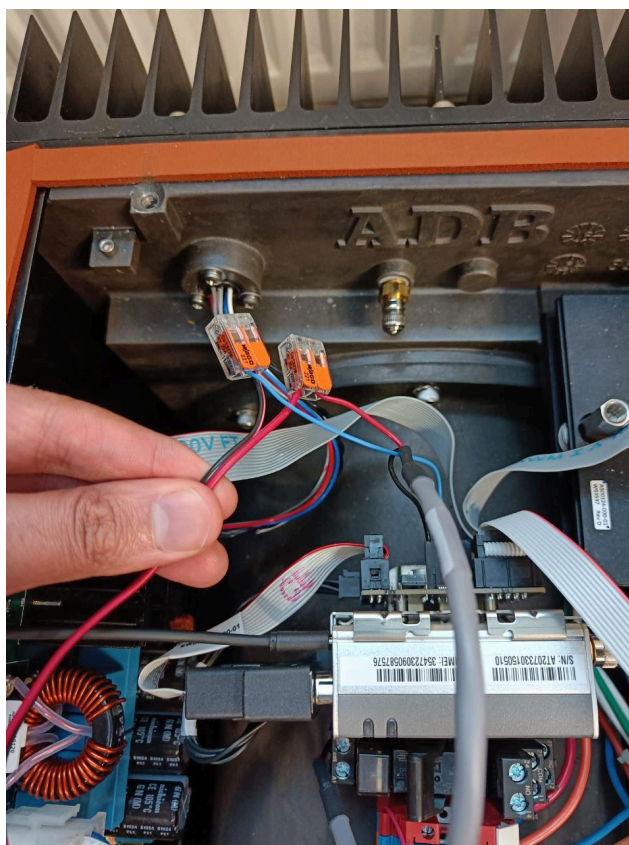


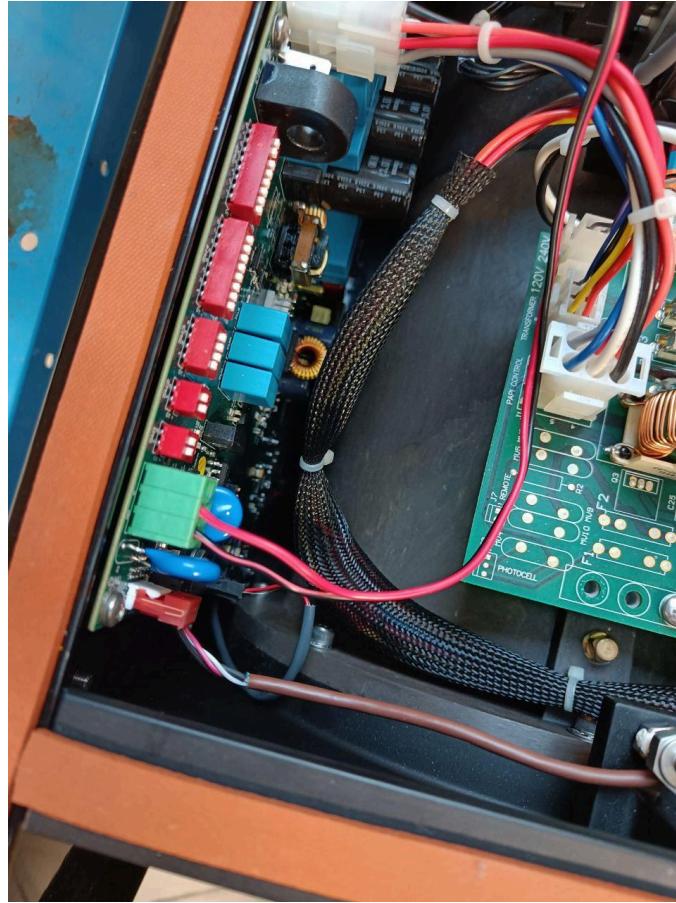
### Note

The pin header shown in the figure above has the same pinout as the one on the PAPI control board.



To connect the alarm wires, a pair of about 20cm extension wires and two pieces of Wago wire-wire connector will be needed:





### Step 8: Power up the PAPI

After connecting all of the connectors and verifying them, the PAPI can be powered up. After powering up, two visible LEDs on the board will turn on.

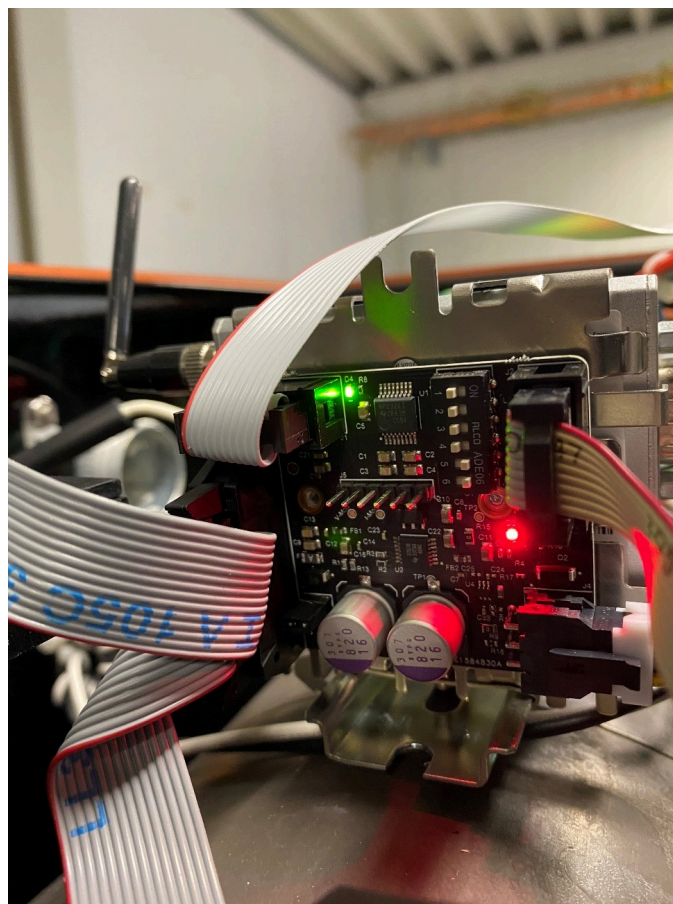
Item	Color	Indication
LED1	Red	The board is powered by +12V
LED2	Green	The serial communication power (+5V)



### Note

If continuous data connection is required, the PAPI has to be configured for "black current". See the LED PAPI Installation Manual for more details.

---



On the LINC Node the ,power LED will go ON immediately and the LED color shows the status of the device:

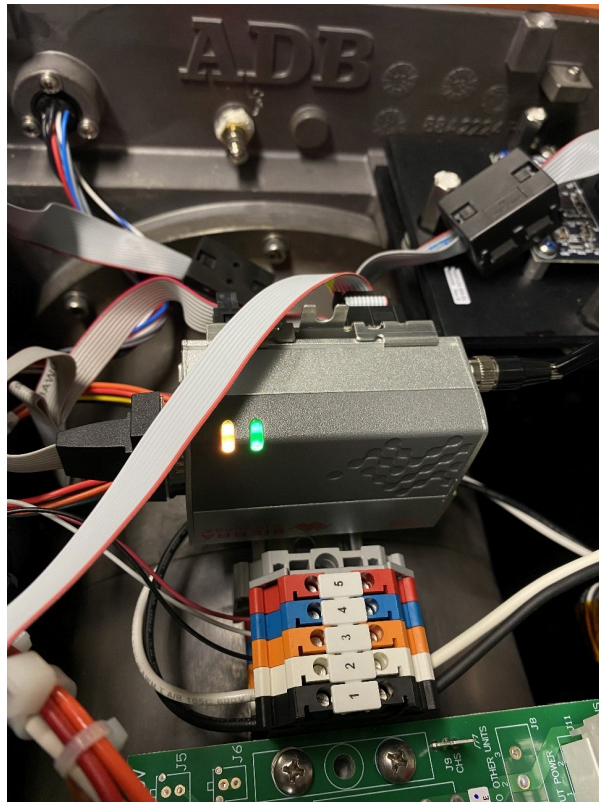


LED	Color/Pattern	Description
Power (Default Behavior)	Off	No power or input voltage $\geq 32\text{VDC}$ or $\leq 4.75\text{VDC}$
	Solid Red	Gateway is powered on, not attached to cellular network.
	Solid Amber	Attached to cellular network
User	Possible Colors <ul style="list-style-type: none"><li>▪ Red</li><li>▪ Green</li><li>▪ Amber</li></ul>	User-defined behavior

If the LINC Node attaches to the network, the power LED will be solid amber.

The next step is waiting for the user LED to turn on:

Color	Indication
Red	No valid serial communication with PAPI
Green	Confirms serial communication with PAPI



### Configuring the Baud Rate of the LINC Node Serial Port

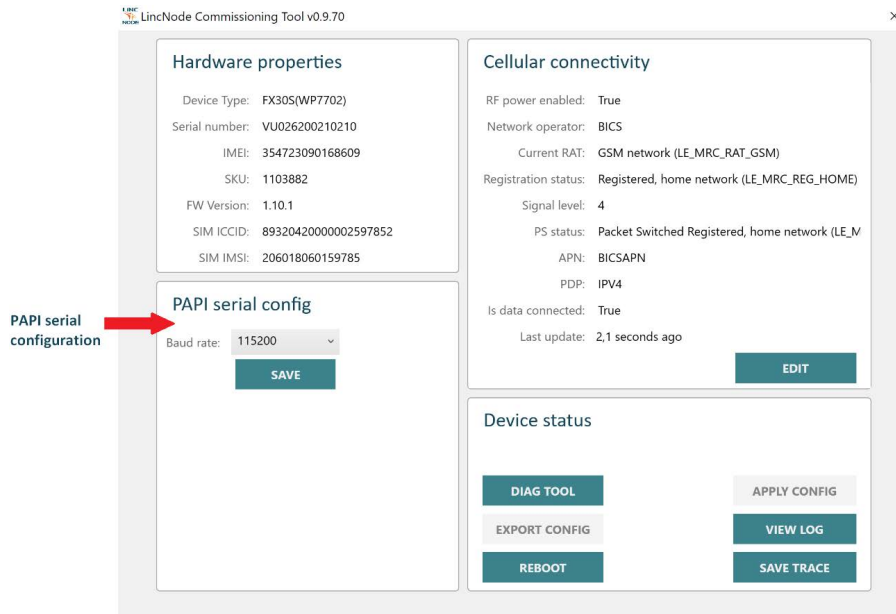
If the LINC Node User LED is GREEN, this process can be skipped. Otherwise, if the User LED remains RED after a few minutes, the following instructions allow configuring the LINC Node baud rate correctly.



#### Note

For old PAPI control boards (LPL models from 2014) running a firmware anterior to version 1.12.0.2, the baud rate of the LINC Node serial port must be configured to 9600 bps. For PAPI control boards running firmware version 1.12.0.2 or a more recent version, the baud rate must be configured to 115200 bps.

Connect a micro-USB cable to the LINC Node and to the laptop. Open the LINC Node Commissioning Tool and wait for the LINC Node device to be detected. Once the device is ready, the application will display the dashboard showing the device information. The interface to configure the LINC Node baud rate should be displayed in the bottom left corner:



Select the appropriate baud rate depending on the PAPI control board firmware version and click **SAVE**. A message box will be displayed to confirm if the change was applied successfully. After one minute, the User LED of the LINC Node should turn GREEN.

## 3.9 LINC Node Replacement

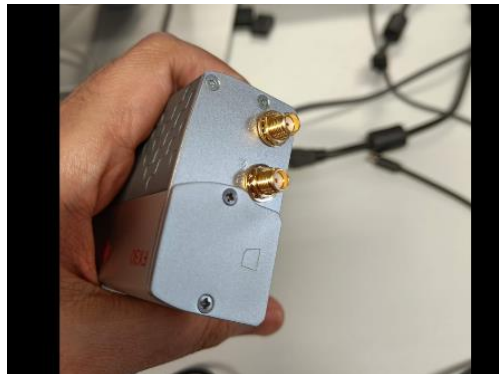
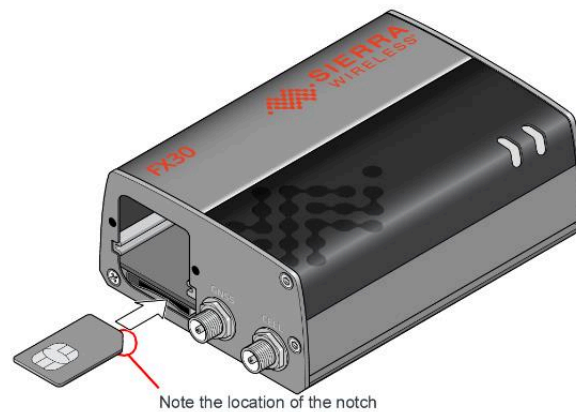
In case of hardware damage, where the LINC Node unit is not usable anymore, a new LINC Node kit (Part No: LN00P1) needs to be acquired.

Upon arrival of the new LINC Node kit, the user needs first to switch the SIM card present in the new unit with the SIM card from the previous LINC Node unit, as follows:

1. Use a Phillips screwdriver (#1) to remove the SIM cover for both old and new LINC Node units.
2. Remove the SIM card from the old unit by pushing it inwards then out. Insert this SIM card in the new unit (scrap the SIM card already present in the new unit from factory) and push it until it clicks.
3. Put the cover back and fasten both screws.

**Figure 34: LINC Node Replacement**

JL



After switching SIM cards, the new unit needs to be installed and commissioned as described in the [LINC Node Commissioning Tool and Process](#) section.

After commissioning the new LINC Node, users need to follow the process described in the [Setting UNIT ID](#) section.



### Note

Make sure you share the IMEI of new unit with the CORTEX Service team to activate the CORTEX Service/cloud connection.

---

**Note**

In case the old SIM card is broken/not usable, users can keep the SIM card present in new LINC Node unit and request a new CORTEX Service LINC Node connection via a JIRA ticket.

---



## 4.0 Commissioning Tool and Process

This section provides information on the LINC Node Commissioning Tool operating instructions. It s applicable to LINC Node devices that have been successfully provisioned and are ready to be used in a real installation.



### WARNING

Maintenance and service personnel performing these operations should have knowledge of LINC Node device properties and functionality, and should be able to perform Modbus RS-485 or Ethernet installations and configuring of slaves/CCRs (for connected CCRs) and serial configuration (for connected LED PAPI).

The Commissioning Tool application offers a convenient environment for the following commissioning activities:

- Monitoring device cellular network and data connectivity status
- Configuration of the application mode: PAPI or CCR
- Configuration of the Modbus interface
- Configuration of the Modbus assets (CCRs)
- Configuration of the serial port for connection to PAPI

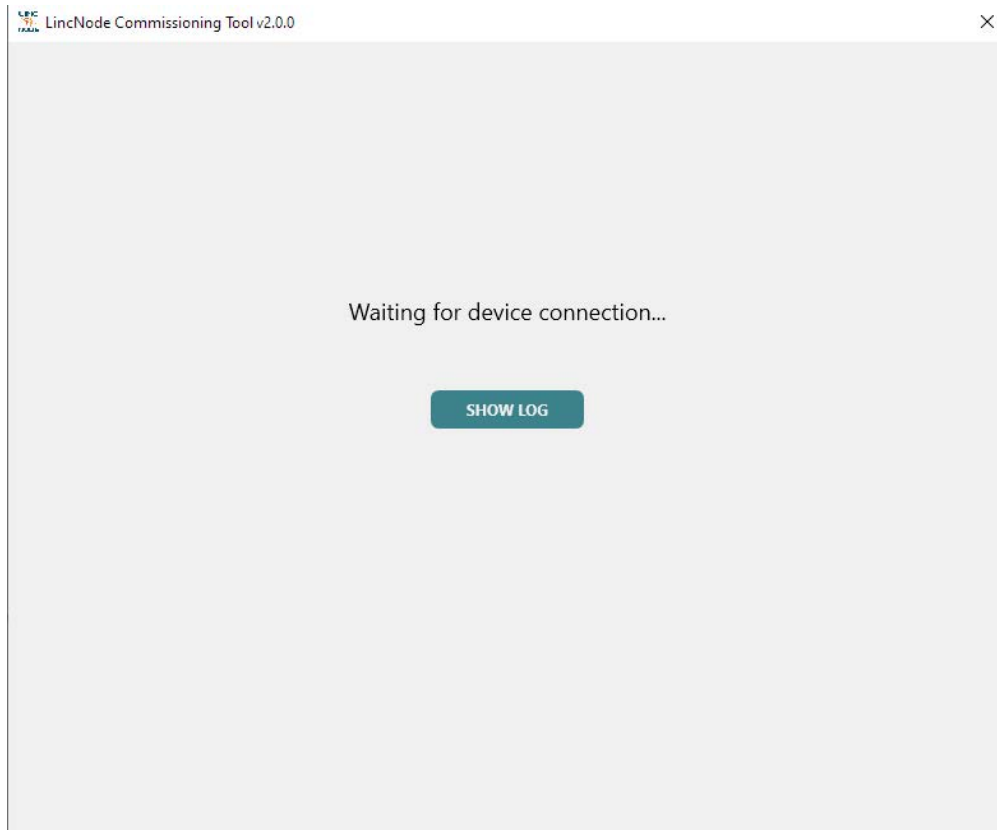
## 4.1 Commissioning Tool Operation

### Login and Automatic Device Identification

Make sure the device is powered on and it is connected to your computer using a suitable micro-USB cable (for reference, a [Mouser](#) cable).

Start the application by executing "LnCommTool.exe". The program verifies all necessary files are present and the application window appears. The "Waiting for device connection" message will appear first. This process may last 1-1.5 minutes from the moment a powered-on LINC Node device is connected to a PC. The "Show log" button allows viewing the application log messages that provide more details on ongoing operations.

**Figure 35: Application Window Main Screen - Waiting for Device Connection**



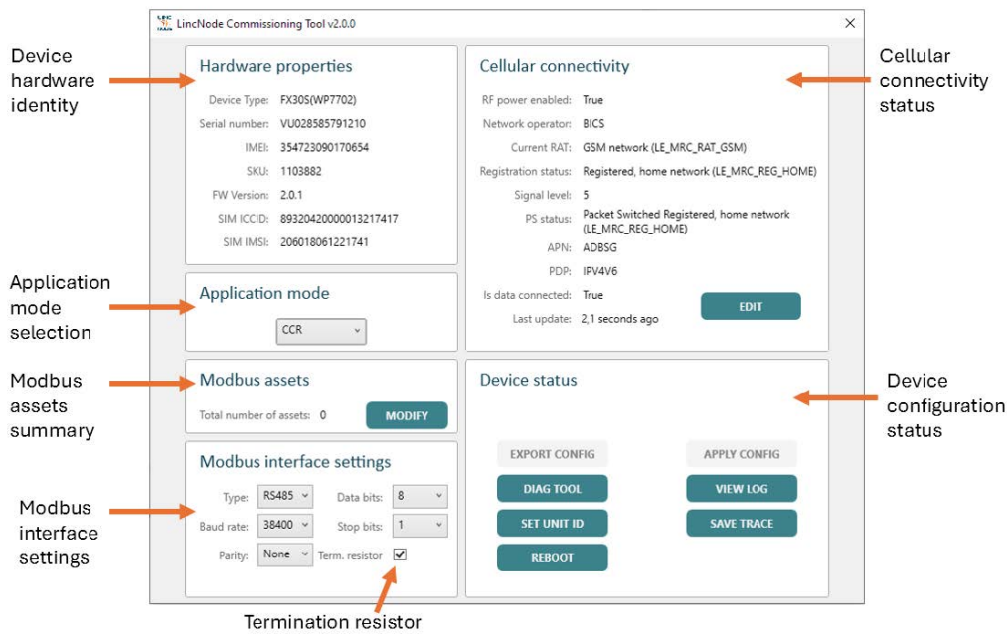
When the application successfully detects the device, the dashboard screen appears.

### Configuring and Monitoring the Device with the Dashboard

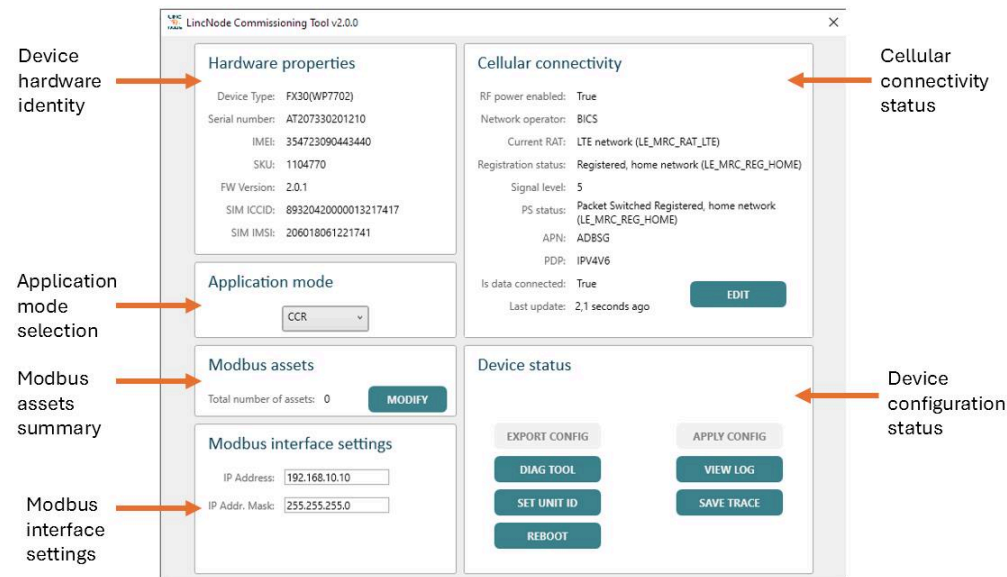
The dashboard screen (Figure 36) consists of the following sections:

- **Hardware properties** displays key device properties, such as serial number and IMEI, among others
- **Cellular connectivity** shows device cellular network and data connectivity status
- **Modbus assets** shows the number of Modbus assets (CCRs) configured
- **Modbus interface settings** section allows to configure IO properties of the physical interface that is used to operate Modbus protocol. This section is different depending on the type of Modbus interface Lincnode device supports (Serial or Ethernet). Serial- and Ethernet-device dashboards are illustrated in Figure 2 and Figure 3 respectively.
- **Modify** button opens CCRs configuration page.
- **Application mode** shows the current operating mode. Mode can be changed here.
- **Device status** section only has indication whether devices settings changed and new configuration needs to be applied (button "Apply config"). It also allows to view the application log messages (button "View log").

**Figure 36: Serial Device Dashboard View**



**Figure 37: Ethernet Device Dashboard View**



### Verifying Device Cellular Network Registration

Prior to configuring Modbus interface and assets, it must be ensured that the device has been registered on the cellular network and the data connectivity is enabled. All the required information can be viewed at the **Cellular Connectivity** section, in the following parameters:

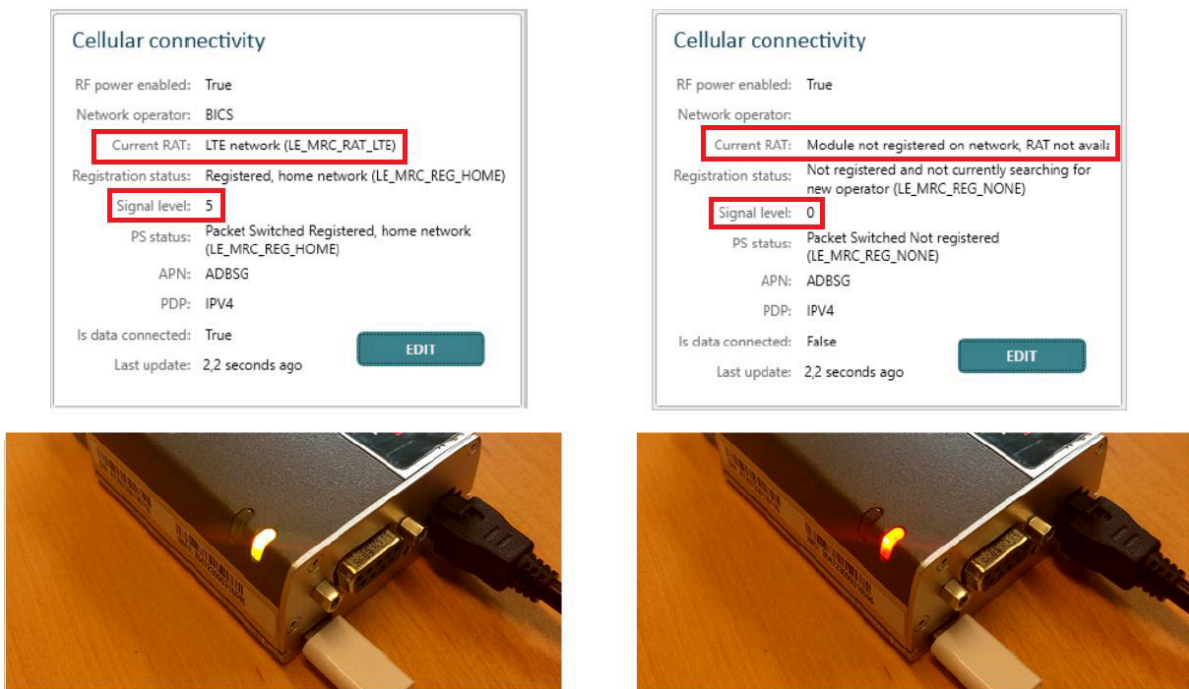
**Table 7: Cellular Connectivity Status Essential Parameters**

Parameter	Expected Value	Error
Current RAT	A message indicating either LTE or GSM network presence	"Not registered" message
Signal level	Any value above zero	0
Is data connected	True	False

An alternative way to observe cellular network status is the color of the Status LED on the LINC Node unit:

- **Amber LED:** Device is registered on the network.
- **Red LED:** There is a problem. Figure 4 shows how parameters in the Cellular connectivity section correspond to the color of Status LED.

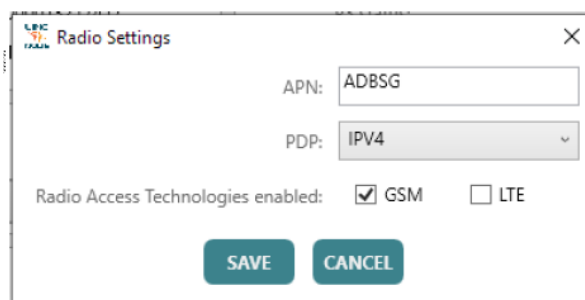
**Figure 38: Cellular Network Status and Status LED (Left Amber, Right Red )**



### Modifying Radio Settings (Not Required by Default)

The tool also allows changing radio settings, such as APN, PDP type and Radio Access Technologies. If a change in one of those settings is required, click "Edit" at the Cellular Connectivity section. This opens a configuration window displaying the current settings:

**Figure 39: Radio Settings Window**



## 4.2 LINC Node for CCR

Prepare all the materials and setups required for the process according to the installation documents RD3 and RD4:

- Windows 10 compatible PC or laptop connected to Internet with Sierra-Wireless WP7702 driver installed.
- Provisioned LINC Node device assembly with power supply and circuit breaker.
- Installation of properly configured CCRs with Modbus interface connection established.
- Micro-USB cable.

### Commissioning Process

The following steps are required for successful commissioning of the LINC Node device:

1. Power up LINC Node device and run the Commissioning Tool application.
2. Verify that the LINC Node device is identified from the dashboard of the Commissioning Tool.
3. Verify that the LINC Node device is registered on the cellular network.
4. Configure Modbus interface settings.
5. Configure the list of CCRs.
6. Apply the configuration.
7. Write down the configuration and provide it to the CORTEX Service team. (Alternatively, click **EXPORT CONFIG** on the **Device Status** pane. Save it as an CSV and provide this file in a JIRA ticket).

### Configuring Modbus Interface and the CCRs

If the cellular network registration of the LINC Node was successful, the commissioning process can continue by (1) configuring the Modbus interface and (2) adding the connected assets (CCRs).

1. In the **Modbus Interface Settings** section enter the correct parameters:
  - For an Ethernet device: enter LINC Node unit IP address and mask (CIDR format)
  - For a Serial device: enter serial interface configuration (baud rate, data bits, stop bits, parity) and enable the termination resistor checkbox
2. Click "Modify" on the **Modbus assets** section. The application window will show the CCRs configuration page [xref].

The following figure shows a blank configuration page for the Ethernet version of the LINC Node device. In case of a Serial device, IP address and Port settings will not be shown.

**Figure 40:** Assets Configuration Screen without Configured Units

The screenshot shows the 'LincNode Commissioning Tool v2.0.0' window. On the right side, there is a 'Selected unit' configuration panel. It contains the following fields and values:

- RTU Address: 1
- Protocol: MCR3 (dropdown menu)
- Reference: (empty)
- UID: (empty)
- IP Address: 192.168.10.100
- Port: 502

Below the configuration fields, there are five buttons: ADD, DUPLICATE, REMOVE, CLEAR, and RETURN. The ADD, RETURN, and CLEAR buttons are highlighted in a teal color, while DUPLICATE and REMOVE are in a light grey color.

Enter the RTU address, select the protocol (MCR2 or MCR3), IP address and TCP port (in case of Ethernet device) of the CCR unit you wish to add and click **Add**. The unit should appear in the list.

This page allows adding, duplicating and deleting units (Figure 7). Individual unit parameters can be modified by selecting a single unit and directly editing its settings.

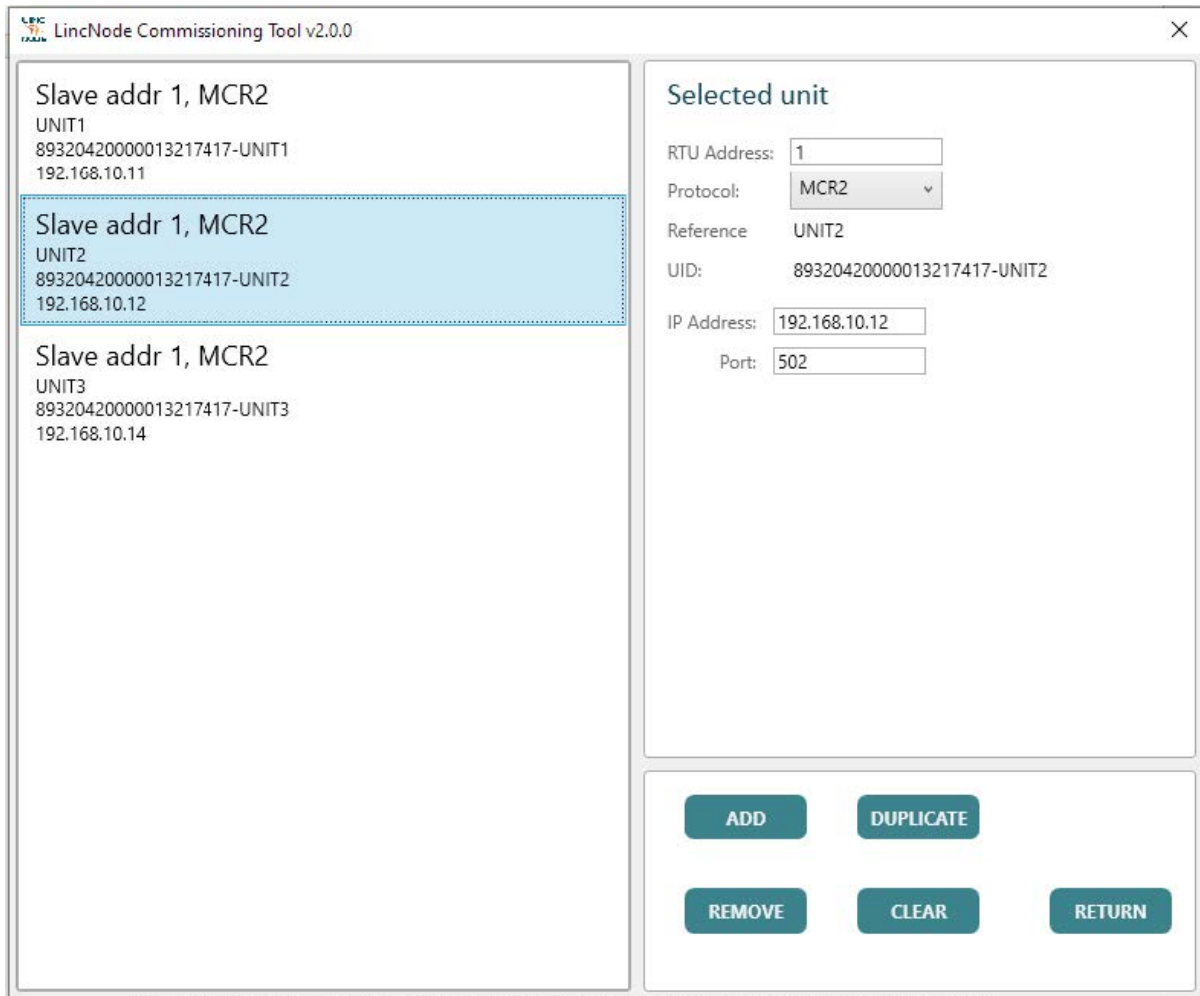


**Note**

All listed units should operate using a single protocol.

After configuring all units, click **Return** to return to the dashboard screen.

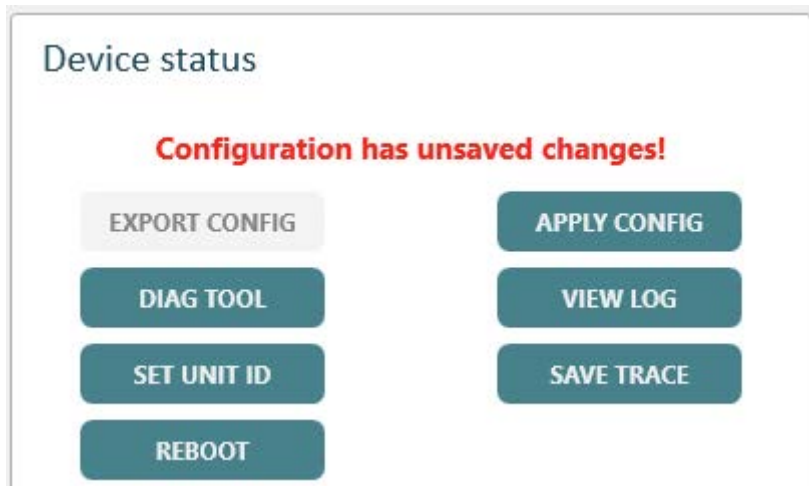
**Figure 41: Assets Configuration Screen with Several Configured Units**



### Finalizing the Configuration

Upon return to the dashboard screen after configuring units, the **APPLY CONFIG** option is enabled and the message "Configuration has unsaved changes" is displayed (Figure 8). After changes are saved, click **APPLY CONFIG**. After the configuration is applied, the application will notify the user with a message box.

**Figure 42: Device Status Indicating Presence of Unsaved Configuration**



### Providing the Configuration Details to the CORTEX Service Team via JIRA Ticket

When the commissioning process has been completed, write down the following:

- **List of CCRs** — names, RTU addresses (and IP addresses in case of Ethernet), protocol
- **Location** of the unit or **substation coordinates**
- **Serial port configuration** — baud rate, parity, number of data and stop bits.

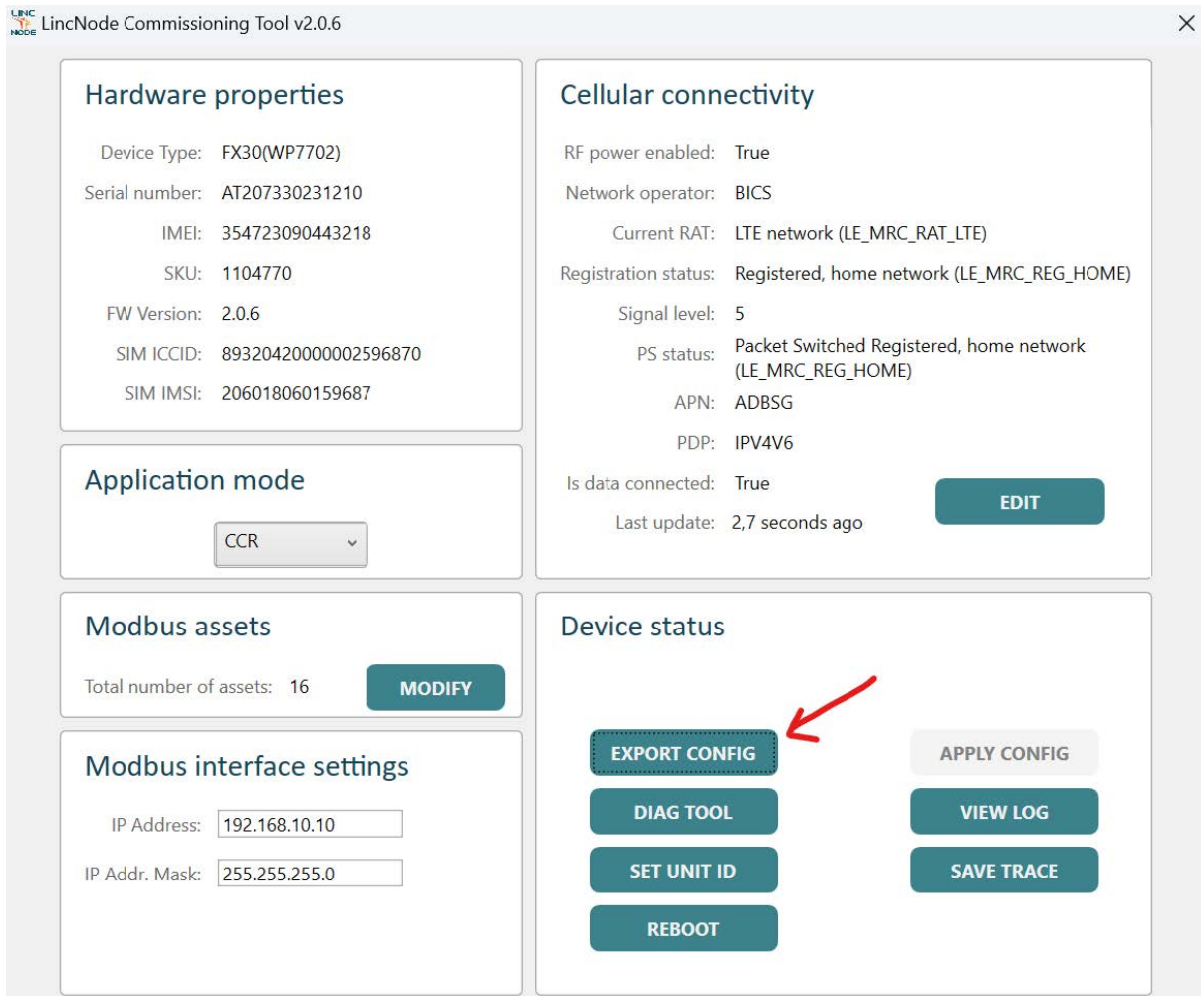
Alternatively, go to **Device Status** pane and click **EXPORT CONFIG**. Save the file and provide it in the JIRA ticket.



#### Note

The JIRA ticket can be opened from [this URL](#).

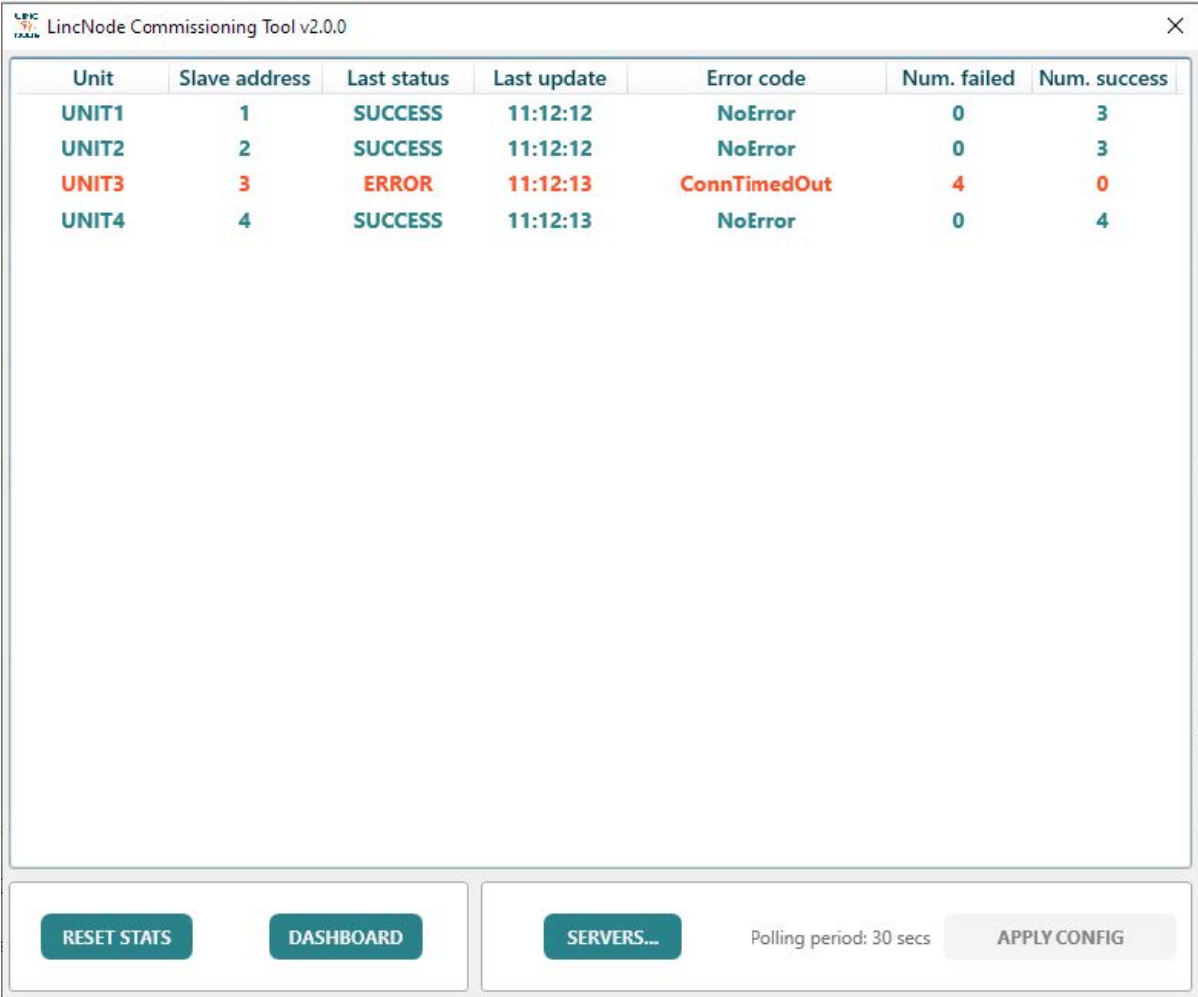
Figure 43: Export Config Option



### Diagnostics Interface

The commissioning tool offers a diagnostics interface to check assets configuration. Click **DIAG TOOL** to open this interface:

**Figure 44:** Diagnostics Interface for CCR



The screenshot shows a window titled "LincNode Commissioning Tool v2.0.0". Inside the window is a table with the following data:

Unit	Slave address	Last status	Last update	Error code	Num. failed	Num. success
UNIT1	1	SUCCESS	11:12:12	NoError	0	3
UNIT2	2	SUCCESS	11:12:12	NoError	0	3
UNIT3	3	ERROR	11:12:13	ConnTimedOut	4	0
UNIT4	4	SUCCESS	11:12:13	NoError	0	4

Below the table, there are several controls: "RESET STATS", "DASHBOARD", "SERVERS...", "Polling period: 30 secs", and "APPLY CONFIG".

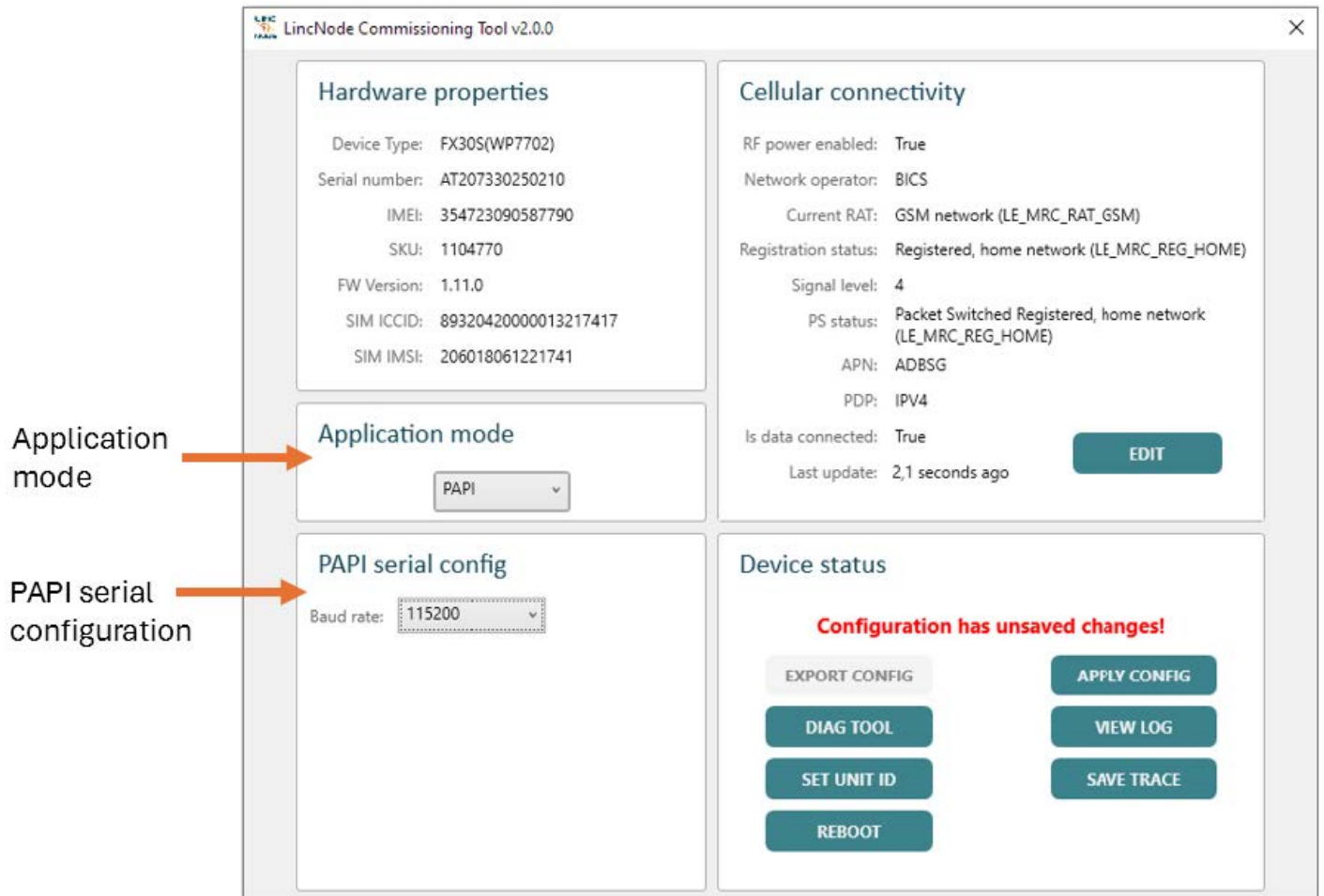
The interface shows all the configured CCRs and their respective status. Clicking **SERVERS** opens the CCR configuration page and allows modifying settings as needed.

## 4.3 LINC Node for PAPI

### Configuring Baud Rate for PAPI

When the LINC Node device operates in PAPI mode, the **Application mode** section displays "PAPI" and there is a **PAPI serial config** section below that allows configuring the baud rate of the serial port.

Figure 45: Commissioning Tool Dashboard for PAPI



Select the appropriate baud rate depending on the PAPI control board (9600 bps or 115200 bps) and click **APPLY CONFIG** button to save the configuration to the device. A message box will be displayed to confirm whether the change was applied successfully.

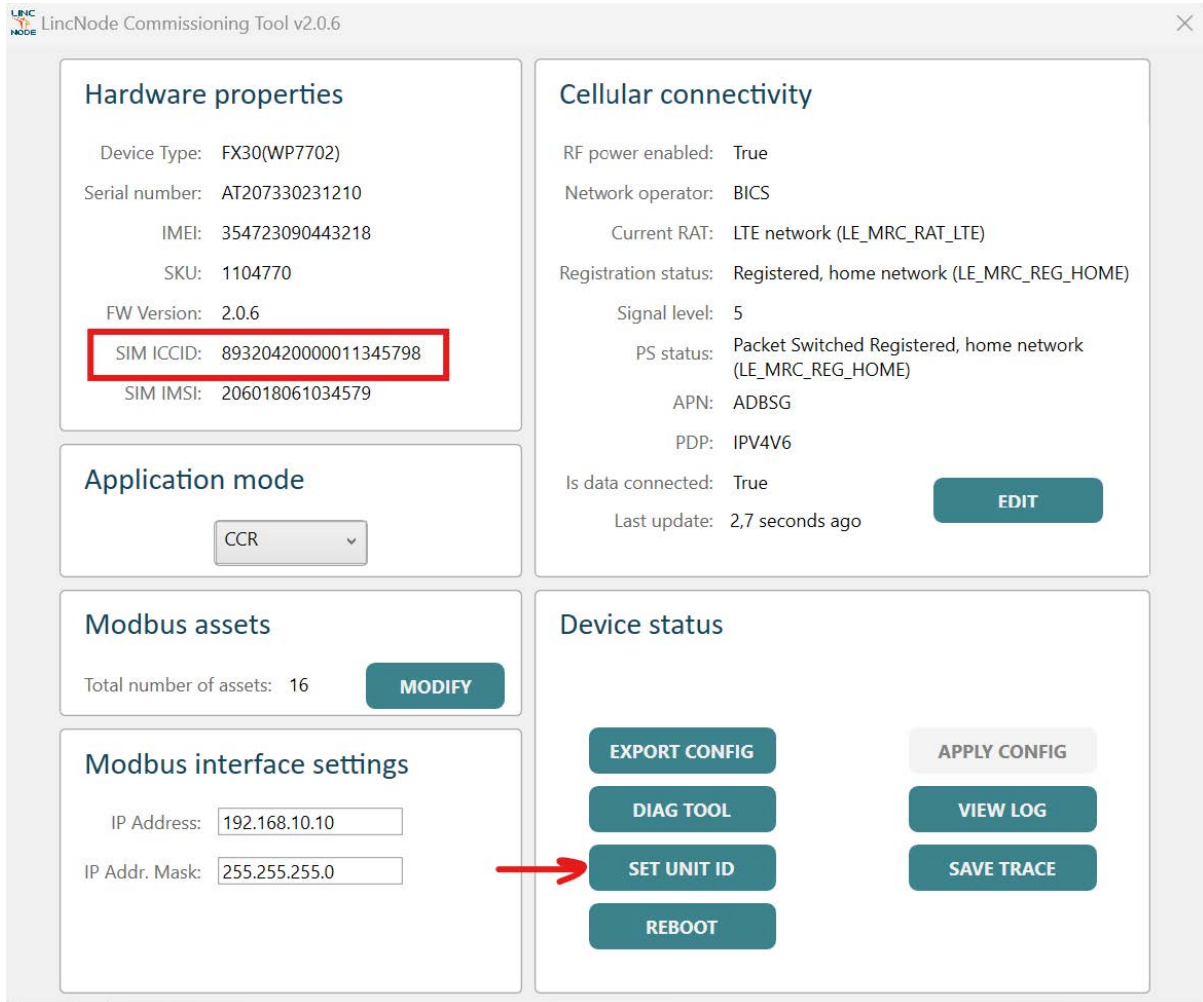


### Note

For old PAPI control boards (LPL models from 2014), running a firmware anterior to version 1.12.0.2, the baud rate must be configured to 9600 bps. For PAPI control boards running firmware version 1.12.0.2 or a more recent version, the baud rate must be configured to 115200 bps (DEFAULT).

## 4.4 Setting UNIT ID

To set unit IDs (only in case LINC Node hardware replacement), copy the SIM ICCID number, click on **Set unit ID** on the **Device Status** pane and paste the SIM ICCID. Save the new unit ID and then click **APPLY CONFIG** on same pane.



LincNode Commissioning Tool v2.0.6

### Hardware properties

Device Type: FX30(WP7702)  
 Serial number: AT207330231210  
 IMEI: 354723090443218  
 SKU: 1104770  
 FW Version: 2.0.6  
 SIM ICCID: 89320420000011345798  
 SIM IMSI: 206018061

### Cellular connectivity

RF power enabled: True  
 Network operator: BICS  
 Current RAT: LTE network (LE\_MRC\_RAT\_LTE)  
 Registration status: Registered, home network (LE\_MRC\_REG\_HOME)  
 Signal level: 5  
 PS status: Packet Switched Registered, home network

### Application mode

CCR

### Modbus assets

Total number of assets: 16 MODIFY

### Modbus interface settings

IP Address:   
 IP Addr. Mask:

EXPORT CONFIG APPLY CONFIG

DIAG TOOL VIEW LOG

SET UNIT ID SAVE TRACE

REBOOT

Set Unit ID

Current Unit ID: 89320420000002596870

New Unit ID:

SAVE
CANCEL

→

The screenshot displays the LincNode Commissioning Tool v2.0.6 interface, which is organized into several panels:

- Hardware properties:** Lists device details such as Device Type (FX30(WP7702)), Serial number (AT207330231210), IMEI (354723090443218), SKU (1104770), FW Version (2.0.6), SIM ICCID (89320420000011345798), and SIM IMSI (206018061034579).
- Application mode:** Features a dropdown menu currently set to 'CCR'.
- Modbus assets:** Shows 'Total number of assets: 16' with a 'MODIFY' button.
- Modbus interface settings:** Includes input fields for 'IP Address: 192.168.10.10' and 'IP Addr. Mask: 255.255.255.0'.
- Cellular connectivity:** Displays network status including RF power enabled (True), Network operator (BICS), Current RAT (LTE network (LE\_MRC\_RAT\_LTE)), Registration status (Registered, home network (LE\_MRC\_REG\_HOME)), Signal level (5), PS status (Packet Switched Registered, home network (LE\_MRC\_REG\_HOME)), APN (ADBSG), PDP (IPV4V6), and Is data connected (True). It also shows 'Last update: 2,1 seconds ago' and an 'EDIT' button.
- Device status:** Contains a red warning message 'Configuration has unsaved changes!' and a set of control buttons: EXPORT CONFIG, DIAG TOOL, SET UNIT ID, REBOOT, APPLY CONFIG, VIEW LOG, and SAVE TRACE. A red arrow points from EXPORT CONFIG to APPLY CONFIG.

## 5.0 Specifications

This section describes the LINC Node gateway specifications.

**Table 8: Specifications**

<b>Certification and Interoperability</b>	<b>Emissions / Immunity</b>	<ul style="list-style-type: none"> <li>CE (Including EMC Test case for vehicle installation EN301489)</li> <li>ACMA RCM</li> <li>FCC</li> <li>Industry Canada</li> </ul>
	<b>Safety</b>	<ul style="list-style-type: none"> <li>CB Report IEC 60950-1</li> <li>UL Listed</li> </ul>
	<b>Industry Certification for Vehicles</b>	<ul style="list-style-type: none"> <li>E-Mark UN ECE Regulation No. 10 Rev. 5</li> </ul>
	<b>Environmental Compliance</b>	<ul style="list-style-type: none"> <li>RoHS 2011/65/EU (RoHS 2)</li> <li>WEEE</li> <li>REACH</li> </ul>
	<b>GSM/HSPA+ Certifications</b>	<ul style="list-style-type: none"> <li>PTCRB</li> <li>GCF</li> </ul>
<b>Environmental Testing</b>	<b>Vibration (operational)</b>	MIL-STD-810G, test method 514.6C Category 4 CWV (Composite Wheeled Vehicle)
	<b>Shock (operational)</b>	MIL-STD-810G, test method 516.6
	<b>SAE J1455 (Shock and Vibration) for heavy-duty vehicles</b>	<ul style="list-style-type: none"> <li>Vibration: Section 4.10.4.2 Cab Mount</li> <li>Shock: Section 4.11.3.4 Operational Shock</li> <li>Electrical: 12 and 24 V systems Section 4.13.1—12 and 24 V Section 4.13.2—SAE J1113-11 Level IV</li> </ul>
	<b>Temperature (operational)</b>	MIL-STD-810G, test methods 501.5, 502.5 (-30° to +75°C) <i>Note: Surface temperature is recorded as 82.3°C at 60°C ambient. Final temperature code is subject to change when installed in end enclosure.</i>
	<b>Temperature (non-operational)</b>	MIL-STD-810G, test methods 501.5, 502.5 (-40° to +85°C)
	<b>Thermal shock</b>	MIL-STD-810G, test method 503.5
	<b>Humidity (operational)</b>	MIL-STD-810G, test method 517.5 95% RH over temperature range of +20°C to + 60°C
	<b>IP rating</b>	IP30
<b>Drop (non- operational)</b>	ISTA 2A 2001, test categories 1, 4, 5, and 6	
<b>Electrostatic discharge (ESD)</b>	8 KV contact discharge, 15 V air discharge	
<b>Mobile Network Operator Certification (pending)</b>	AT&T (planned)	
<b>Network Technology</b>	<b>LTE, HSPA+ GSM /GPRS / EDGE</b>	For lists of supported bands, see <a href="#">Radio Frequency Bands</a>
<b>Host Interfaces</b>	<b>Antenna connectors</b>	<ul style="list-style-type: none"> <li>Cellular</li> <li>GNSS</li> </ul>

**Table 8: Specifications**

	<b>USB</b>	<ul style="list-style-type: none"> <li>▪ USB 2.0 micro-B connector complies with USB Version 2.0 for high speed operation</li> <li>▪ ADB SAFEGATE recommends you: <ul style="list-style-type: none"> <li>▪ Use a USB 2.0 cable</li> <li>▪ Connect directly to your computer for best throughput.</li> </ul> </li> </ul>
	<b>Ethernet</b>	<ul style="list-style-type: none"> <li>▪ 10/100 Base-T RJ-45 Ethernet</li> <li>▪ Auto-crossover support</li> <li>▪ Auto-negotiation, full- and half-duplex</li> <li>▪ Not software configurable</li> </ul>
	<b>Serial</b>	<ul style="list-style-type: none"> <li>▪ RS-485 half-duplex</li> <li>▪ Maximum baud rate: 115200 bit/s</li> <li>▪ Maximum cable length: 25 meters at 115200 bit/s, 40 meters at 38400 bit/s.</li> </ul>
	<b>SIM Card Interface</b>	<ul style="list-style-type: none"> <li>▪ Mini-SIM (2FF) SIM card operated at 1.8 V/3.3 V.</li> </ul>
<b>Power Adapter Pins</b>		6-Pin connector: <ul style="list-style-type: none"> <li>▪ Power</li> <li>▪ Ground</li> <li>▪ On/Off</li> <li>▪ I/O1</li> <li>▪ I/O2</li> <li>▪ I/O3</li> </ul>
<b>LEDs</b> <b>See LED Behavior</b>		2 LEDs: <ul style="list-style-type: none"> <li>▪ Power</li> <li>▪ User configurable</li> </ul>
<b>Mechanical Specifications</b> <b>For mechanical drawings, dimensions, and weight, see Mechanical Specifications</b>		<ul style="list-style-type: none"> <li>▪ Housing—The LINC Node is made of ruggedized powder-coated aluminum.</li> <li>▪ RoHS2—The LINC Node complies with the Restriction of Hazardous Substances Directive 2011/65/EU (RoHS2). This directive restricts the use of hazardous materials in the manufacture of various types of electronic and electrical equipment.</li> </ul>
<b>Screw Torque Settings</b>		<ul style="list-style-type: none"> <li>▪ Mount screws 1.1 N-m (10 in-lb)</li> <li>▪ Antennas Finger tight (5–7in-lb.) is sufficient and the max torque should not go beyond 1.1 N-m (10 in-lb).</li> </ul>
<b>Operating Voltage</b>		4.75 to 32 VDC
<b>GNSS Technology</b>	<b>Satellite channels available</b>	Acquisition: 118 Simultaneous tracking: 40
	<b>Support for predicted orbits</b>	Yes
	<b>Predicted orbit CEP- 50 accuracy</b>	5 meters
	<b>Constellations</b>	
	<b>GNSS Message Protocol</b>	NMEA

**Table 8: Specifications**

<b>Standalone Time to First Fix (TTFF)</b>	<ul style="list-style-type: none"> <li>▪ Hot start: 1 second</li> <li>▪ Warm start: 29 seconds</li> <li>▪ Cold start: 32 seconds</li> </ul>
<b>Sensitivity</b>	Standalone or MS-based tracking sensitivity: -158 dBm Cold start sensitivity: -143 dBm MS-assisted GNSS acquisition sensitivity: -156 dBm

## 5.1 Radio Frequency Bands

**Table 9: LINC Node Radio Module WP8548**

Radio Technology	Band	Frequency (Tx)	Frequency (Rx)
<b>HSPA+</b>	Band 1	1920–1980 MHz	2110–2170 MHz
	Band 2	1850–1910 MHz	1930–1990 MHz
	Band 5	824–849 MHz	869–894 MHz
	Band 6	830–840 MHz	875–885 MHz
	Band 8	880–915 MHz	925–960 MHz
	Band 19	830– 845 MHz	875–890 MHz
<b>GSM / GPRS / EDGE</b>	Band 850	824–849 MHz	869–894 MHz
	Band 900	880–915 MHz	925–960 MHz
	Band 1800	1710–1785 MHz	1805–1880 MHz
	Band 1900	1850–1910 MHz	1930–1990 MHz

**Table 10: LINC Node Radio Module WP7607-1**

Radio Technology	Band	Frequency (Tx)	Frequency (Rx)
<b>LTE</b>	Band 1	1920 –1980 MHz	2110–2170 MHz
	Band 3	1710 –1785 MHz	1805–1880 MHz
	Band 7	2500 –2570 MHz	2620–2690 MHz
	Band 8	880 –915 MHz	925–960 MHz
	Band 20	832 –862 MHz	791–821 MHz
	Band 28	703 –748 MHz	758–803 MHz
<b>HSPA+</b>	Band 1	1920 –1980 MHz	2110– 2170 MHz
	Band 8	880 –915 MHz	925–960 MHz
<b>GMS/GPRS/EDGE</b>	900	880 –915 MHz	925–960 MHz
	1800	1710 –1785 MHz	1805–1880 MHz

**Table 11: LINC Node Radio Module WP7702**

Radio Technology	Band	Frequency (Tx)	Frequency (Rx)
<b>LTE</b>	Band 1	1920 –1980 MHz	2110– 2170 MHz
	Band 2	1850 –1910 MHz	1930– 1990 MHz

**Table 11: LINC Node Radio Module WP7702**

Radio Technology	Band	Frequency (Tx)	Frequency (Rx)
	Band 3	1710 -1785 MHz	1805-1880 MHz
	Band 4	1710 -1755 MHz	2110-2155 MHz
	Band 5	824 -849 MHz	869-894 MHz
	Band 8	880 -915 MHz	925-960 MHz
	Band 12	699 -716 MHz	729 -746 MHz
	Band 13	777 -787 MHz	746-756 MHz
	Band 17	704 -716 MHz	734-746 MHz
	Band 18	815 -830 MHz	860-875 MHz
	Band 19	830 -845 MHz	875-890 MHz
	Band 20	832 -862 MHz	791-821 MHz
	Band 26	814 -849 MHz	859-894 MHz
	Band 28	703 -748 MHz	758-803 MHz
	<b>GSM / GPRS / EDGE</b>	Band 850	824 -849 MHz
Band 900		880 -915 MHz	925-960 MHz
Band 1800		1710 -1785 MHz	1805-1880 MHz
Band 1900		1850 -1910 MHz	1930- 1990 MHz

**Table 12: LINC Node Radio Module WP7611-1**

Radio Technology	Band	Frequency (Tx)	Frequency (Rx)
<b>LTE</b>	Band 2	1850 -1910 MHz	1930- 1990 MHz
	Band 4	1710 -1755 MHz	2110-2155 MHz
	Band 5	824 -849 MHz	869-894 MHz
	Band 12	699 -716 MHz	729 -746 MHz
	Band 13	777 -787 MHz	746-756 MHz
	Band 14	788 -798 MHz	758-768 MHz
	Band 25	1850 -1915 MHz	1930-1995 MHz
	Band 26	814 -849 MHz	859-894 MHz
	Band 66	1710 -1780 MHz	2110-2200 MHz
	Band 71	663 -698 MHz	617-652 MHz
<b>UMTS</b>	Band 2	1850 -1910 MHz	1930-1990 MHz
	Band 4	1710 -1755 MHz	2110-2155 MHz
	Band 5	824 -849 MHz	869-894 MHz

**Table 13: GNSS Bands Supported**

Band	Frequency
GPS L1	1575.42 MHz
GLONASS L1 FDMA	1602 MHz
Galileo E1	1575.42 MHz
BeiDou (WP7607-1/WP7702/WP7611-1)	1561.098 MHz
QZSS (WP7607-1/WP7611-1)	1575.42 MHz

## 5.2 Radio Module Conducted Transmit Power

The following tables provide radio module conducted transmit power specifications.

**Table 14: Radio Module WP8548 Conducted Transmit Power**

Band	Conducted Tx Power (dBm)	Notes
<b>HSPA+</b>		
Band 1 (IMT 2100 12.2 kbps)	+23 ±1	Connectorized (Class 3)
Band 2 (HSPA+ 1900 12.2 kbps)		
Band 5 (HSPA+ 850 12.2 kbps)		
Band 6 (HSPA+ 800 12.2 kbps)		
Band 8 (HSPA+ 900 12.2 kbps)		
Band 19 (HSPA+ 850 12.2 kbps)		
<b>GSM/GPRS/EDGE</b>		
GSM 850	+32 ±1	GMSK mode, connectorized (Class 4, 2 W; 33 dBm)
E-GSM 900	+32 ±1	
DCS 1800	+29 ±1	GMSK mode, connectorized (Class 1, 1 W; 30 dBm)
PCS1900	+29 ±1	
GSM 850	+26.5±1	8PSK mode, connectorized (Class E2; 0.5 W; 27 dBm)
E-GSM 900	+26.5±1	
DCS 1800	+25.5±1	8PSK mode, connectorized (Class E2; 0.4 W; 26 dBm)
PCS1900	+25.5±1	

**Table 15: Radio Module WP7607-1 Conducted Transmit Power**

Band	Conducted Tx Power (dBm)	Notes
<b>LTE</b>		
Bands 1, 3, 7, 8, 20, 28	+23±1	Connectorized (Class 3)
<b>HSPA+</b>		
Band 1	+23±1	Connectorized (Class 3)
Band 8		

**Table 15: Radio Module WP7607-1 Conducted Transmit Power**

Band	Conducted Tx Power (dBm)	Notes
<b>GSM/GPRS/EDGE</b>		
E-GSM 900	33+1/-2	GMSK mode, connectorized (Class E4; 2 W; 33 dBm)
	27±2.5	8PSK mode, connectorized (Class E2; 0.5 W; 27 dBm)
DCS 1800	30+1/-2	GMSK mode, connectorized (Class 1, 1 W; 30 dBm)
	26±2.5	8PSK mode, connectorized (Class E2; 0.4 W, 26 dBm)

**Table 16: Radio Module WP7702 Conducted Transmit Power**

Band	Conducted Tx Power (dBm)	Notes
<b>LTE</b>		
Bands 1, 2, 3, 4, 5, 8, 12, 13, 17, 18, 19, 20, 26, 28	+23±1	
<b>GSM/GPRS/EDGE</b>		
GSM 850	+32±1	GMSK mode (Class 4; 2 W, 33 dBm)
	+27±1	8PSK mode (Class E2; 0.5 W, 27 dBm)
E-GSM 900	+32±1	GMSK mode (Class 4; 2 W, 33 dBm)
	+27±1	8PSK mode (Class E2; 0.5 W, 27 dBm)
DCS 1800	+29±1	GMSK mode (Class 1; 1 W, 30 dBm)
	+26±1	8PSK mode (Class E2; 0.4 W, 26 dBm)
PCS 1900	+29±1	GMSK mode (Class 1; 1 W, 30 dBm)
	+26±1	8PSK mode (Class E2; 0.4 W, 26 dBm)

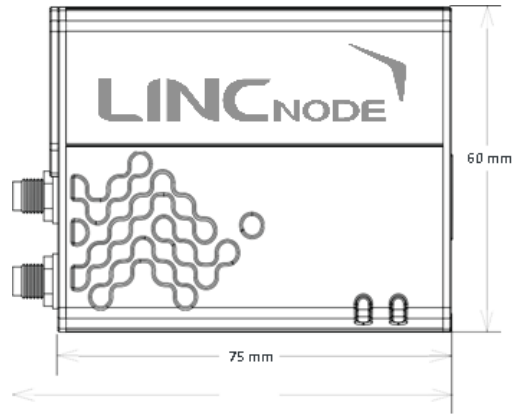
**Table 17: Radio Module WP7611-1 Conducted Transmit Power**

Band	Conducted Tx Power (dBm)	Notes
<b>LTE</b>		
Bands 2, 4, 5, 12, 13, 14, 25, 26, 66, 71	+23±1	Power class 3
<b>WCDMA</b>		
Bands 2, 4, 5	+23±1	Power class 3 bis

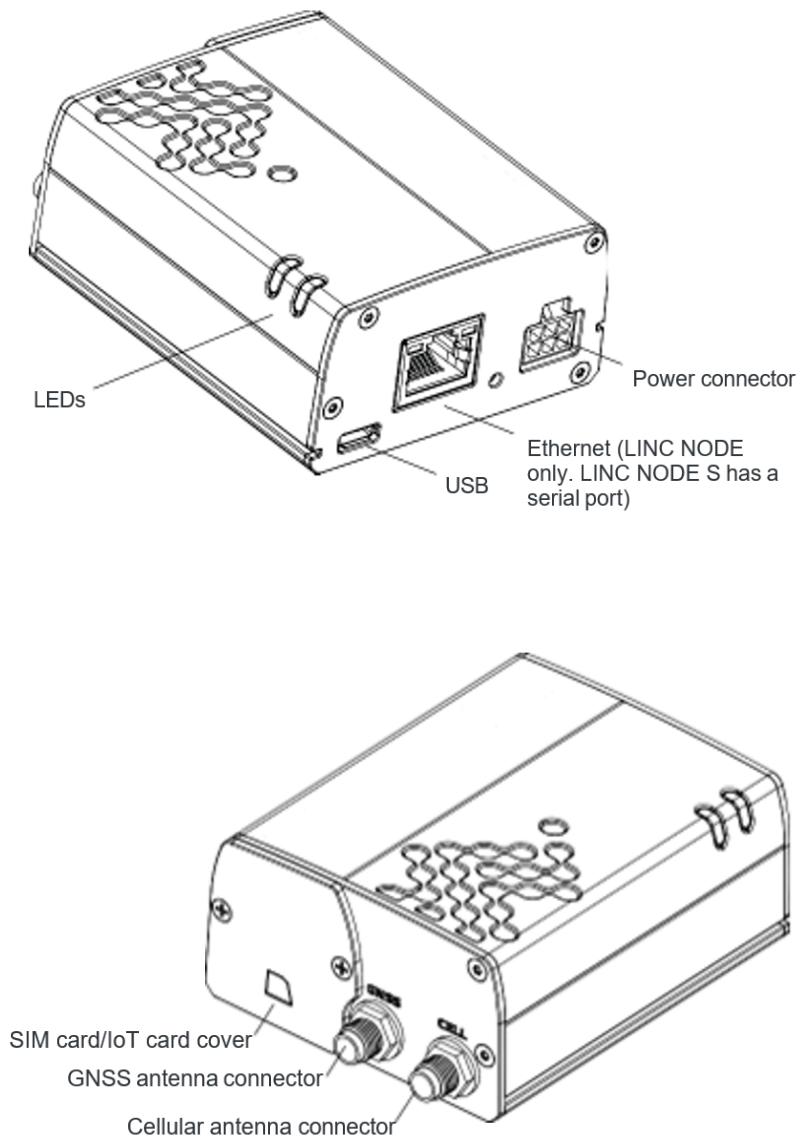
---

## 5.3 Mechanical Specifications

**Figure 46: Top View**

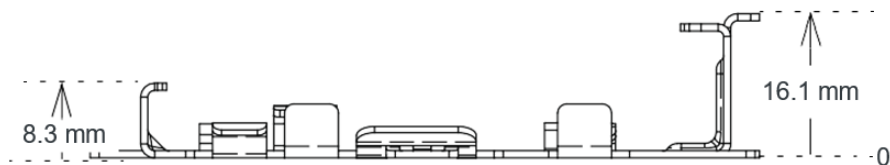


**Figure 47: End Views**



<b>Weight</b>	158 g (5.57 oz.)
<b>Dimensions (l x w x h)</b>	<ul style="list-style-type: none"> <li>▪ 75 × 60 × 32 mm (excluding connectors)</li> <li>▪ 82 × 60 × 32 mm (including connectors)</li> </ul>

**Figure 48: Mounting Bracket (Side View)**



**Figure 49:** Compatibility Bar

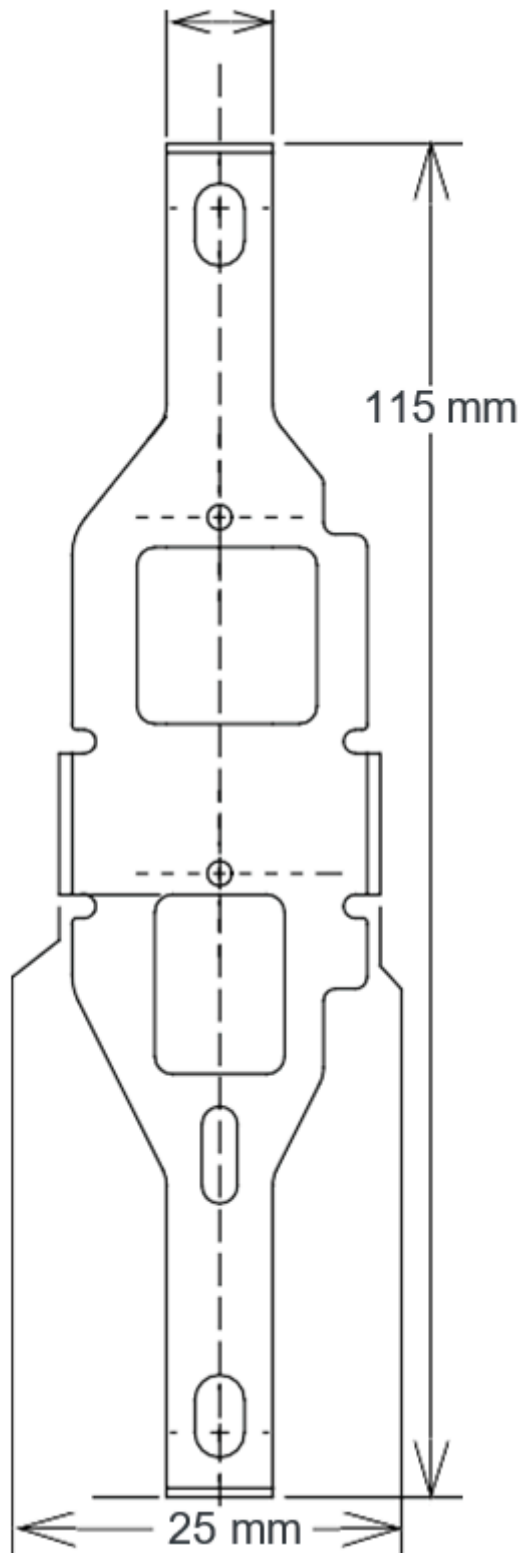


Figure 50: Mounting racket (Top View)

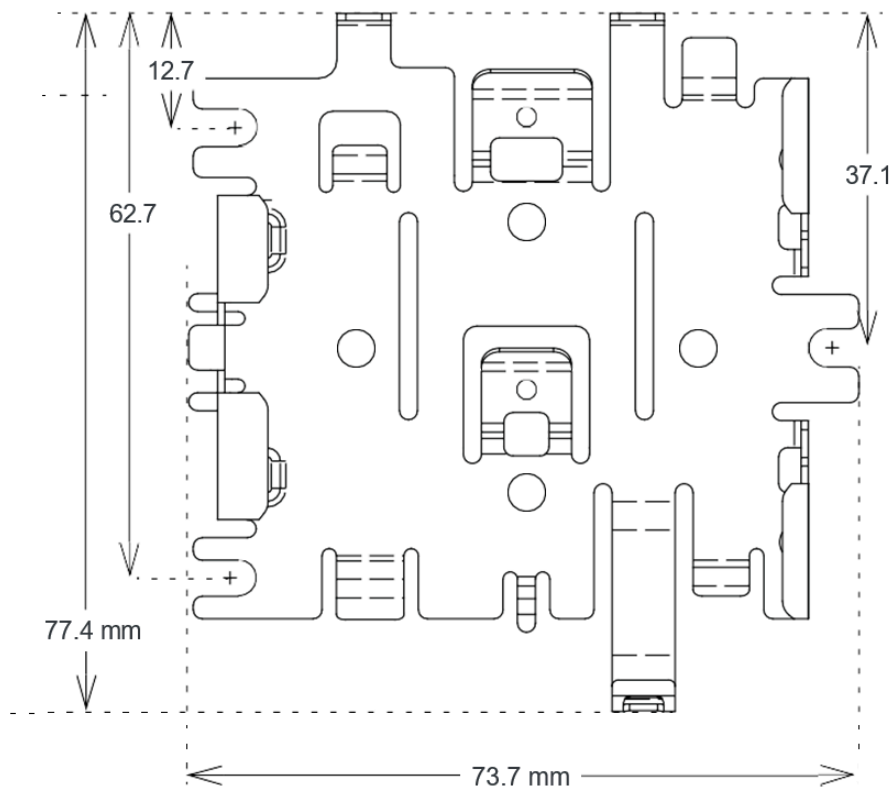


Figure 51: Assembly

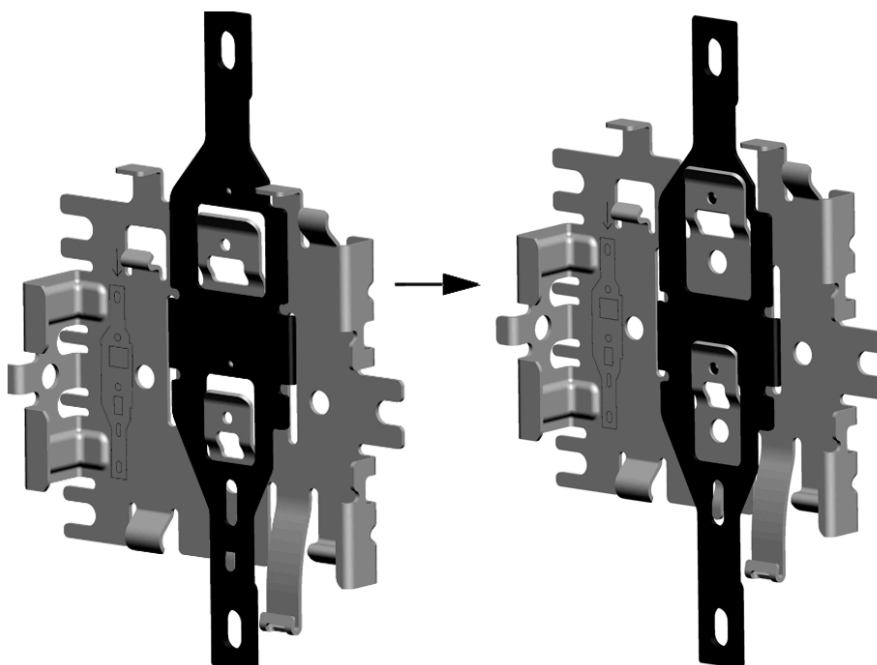
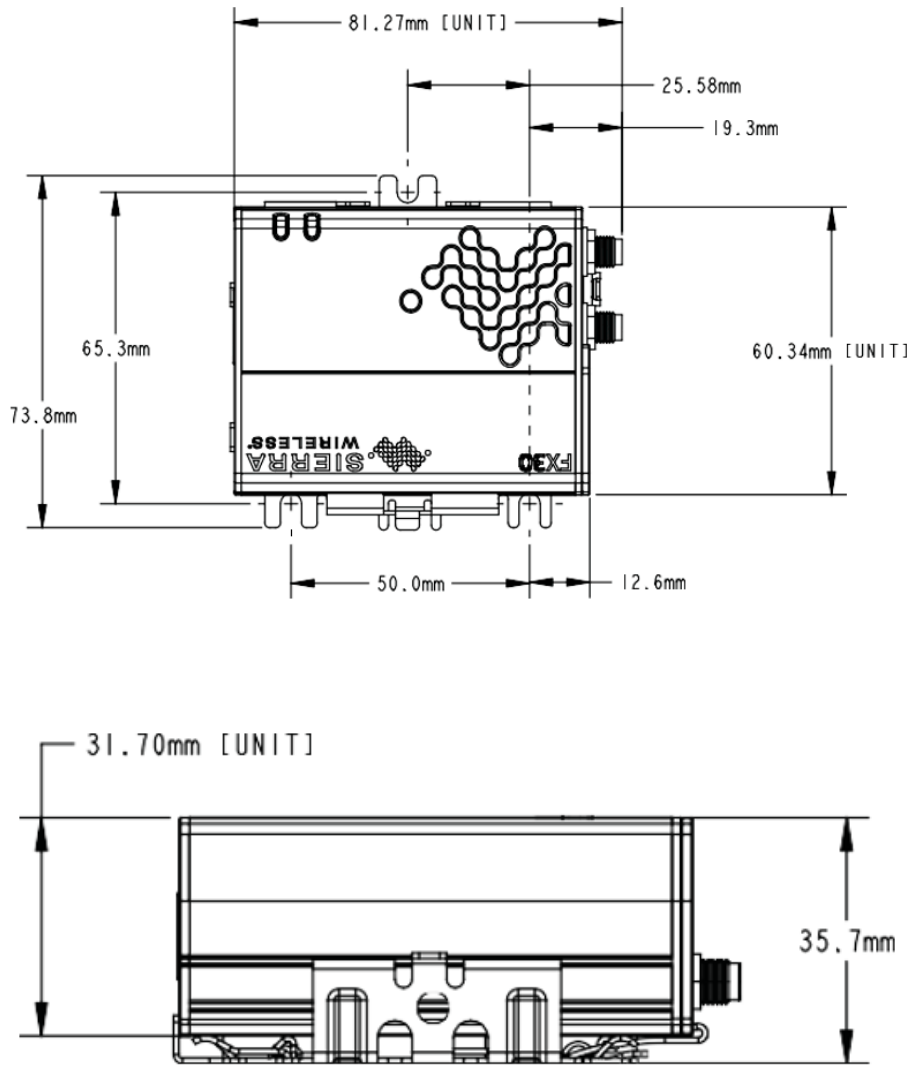
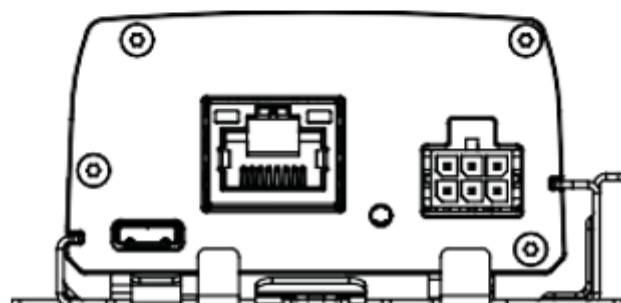
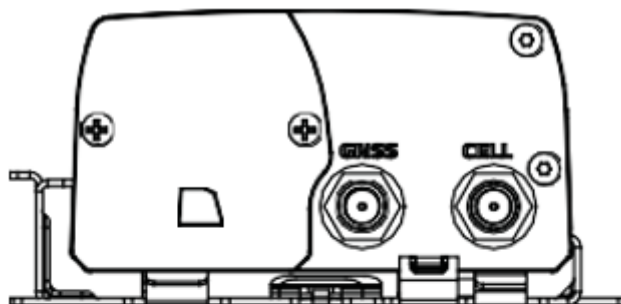


Figure 52: LINC Node on Mounting Bracket (Top, Side and End Views)





## 5.4 Power Consumption

**Table 18: Power Consumption – Active Mode LINC Node 3G (WP8548)**

Mode	Conditions	Voltage	Max continuous		Burst	
		V	mA	mW	mA	mW
<b>Active Idle</b>	USB and Ethernet cables are plugged in	24	40	960		
		12	74	888		
		4.5	180	810	208	936
<b>Active Full Function HSPA+</b>	Max Tx power (+23 dBm) USB 70 Mbps Ethernet 55 Mbps	24	138	3312	145	3480
		12	265	3180	270	3240
		5	604	3020	645	3225
<b>Active Full Function GSM</b>	Max Tx power (+31 dBm) USB 70 Mbps Ethernet 55 Mbps	24	110	2640	308	7392
		12	212	2544	600	7200
		5	550	2750	1670	8350

**Table 19: Power Consumption – Active Mode LINC Node Cat-1 (WP7607-1)**

Mode	Conditions	Voltage	Max continuous		Burst	
		V	mA	mW	mA	mW
<b>Active Idle</b>	USB and Ethernet cables are plugged in	24	94	2254	TBD	
		12	183	2195	TBD	
		4.5	439	1977	TBD	

**Table 20: Power Consumption – Active Mode LINC Node Cat-1 (WP7607-1)**

Mode	Conditions	Voltage V	Max continuous mA   mW		Burst mA   mW
<b>Active Full Function LTE</b>	Max Tx power (-18 dBm) USB 103 Mbps Ethernet 85 Mbps	24	112	2680	TBD
		12	209	2511	TBD
		4.5	542	2441	TBD

**Table 21: Power Consumption – Active Mode LINC Node Cat-M (WP7702)**

Mode	Conditions	Voltage V	Max continuous mA   mW		Burst mA   mW
<b>Active Idle</b>	USB and Ethernet cables are plugged in	24	56	1364	236 5672
		12	114	1371	532 6382
		4.5	254	1141	1339 6027
<b>Active Full Function GSM</b>	Max Tx power (+33 dBm) USB 110 Mbps Ethernet 94 Mbps	24	195	4686	274 6584
		12	357	4282	622 7461
		4.5	918	4133	1560 7022
<b>Active Full Function LTE</b>	Max Tx power (+23 dBm) USB 110 Mbps Ethernet 94 Mbps	24	174	4184	290 6971
		12	319	3824	658 7900
		4.5	820	3690	1652 7435

**Table 22: Power Consumption – Active Mode LINC Node Cat-M (WP7611-1)**

Mode	Conditions	Voltage V	Max continuous mA   mW		Burst mA   mW
<b>Active Idle</b>	USB and Ethernet cables are unplugged	24	57	1359	236 5672
		12	114	1366	532 6382
		4.5	253	1137	1339 6027
<b>Active Full Function LTE</b>	Max Tx power (+33 dBm) USB 110 Mbps Ethernet 94 Mbps	24	198	4747	317 7610
		12	372	4461	718 8625
		4.5	973	4379	1804 8118
<b>Active Full Function HSDPA</b>	Max Tx power (+33 dBm) USB 110 Mbps Ethernet 94 Mbps	24	202	4841	306 7347
		12	379	4543	694 8327
		4.5	993	4469	1742 7837

**Table 23: Power Consumption – Off and Ultra Low Power Modes (all LINC Node variants)**

Mode	Conditions	Voltage V	Max continuous $\mu\text{A}$   $\mu\text{W}$ <sup>1</sup>	
<b>Off</b>	On/Off is set to Off	24	71	1697
		12	36	436

<sup>1</sup>The LINC Node protection circuitry results in the increase in current as voltage increases.

**Table 23: Power Consumption – Off and Ultra Low Power Modes (all LINC Node variants)**

Mode	Conditions	Voltage V	Max continuous $\mu\text{A}$   $\mu\text{W}$
		5	16   78
Ultra Low Power	Triggering timer	24	351   8414
		12	172   2059
		5	168   842

## 5.5 Important Information for North American Users

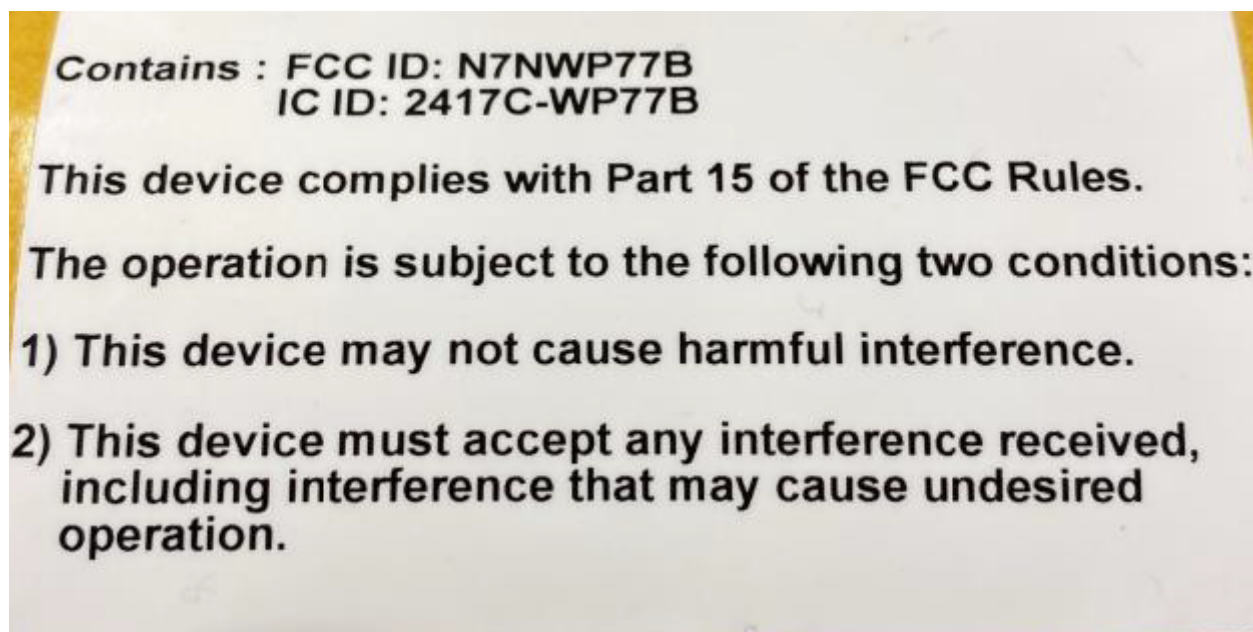


### WARNING

This equipment has been tested and found to comply with the limits for a Class A digital device, pursuant to part 15 of the FCC Rules. These limits are designed to provide reasonable protection against harmful interference when the equipment is operated in a commercial environment. This equipment generates, uses, and can radiate radio frequency energy and, if not installed and used in accordance with the instruction manual, may cause harmful interference to radio communications. Operation of this equipment in a residential area is likely to cause harmful interference, in which case the user will be required to correct the interference at his own expense. Changes or modifications to this device not expressly approved by ADB SAFEGATE could void the user's authority to operate this equipment.

## 5.6 RF Exposure

Please make sure this label is attached to the PAPI body after LINC Node installation:



In accordance with FCC/IC requirements of human exposure to radio frequency fields, the radiating element shall be installed such that a minimum separation distance of 20 cm should be maintained between the antenna and the user's body.



### WARNING

This product is only to be installed by qualified personnel.

To comply with FCC/IC regulations limiting both maximum RF output power and human exposure to RF radiation, the maximum antenna gain must not exceed the specifications listed in the following section for the device used.

## 5.7 Maximum Antenna Gain

The antenna gain must not exceed the limits and configurations shown in the following tables:

Device	Frequency Band	FCC ID/IC Number N7NWP8/2417C-WP8 Maximum Antenna Gain (dBi)
ADB SAFEGATE LINC Node	2	3
	5	4
	GPRS/EDGE 850	4
	GPRS/EDGE 1900	3

Device	Frequency Band	FCC ID/IC Number N7NWP76A/2417C-WP76A Maximum Antenna Gain (dBi)
ADB SAFEGATE LINC Node	4	6
	13	6

Device	Frequency Band	FCC ID/IC Number N7NWP76C/2417C-WP76C Maximum Antenna Gain (dBi)
ADB SAFEGATE LINC Node	2	6
	4	6
	5	6
	12	6
	HSPA+ 2	6
	HSPA+ 4	6
	HSPA+ 5	6

		FCC ID/IC Number N7NWP77B 2417C-WP77B Maximum antenna gain (dBi) <sup>1</sup>	
Device	Frequency Band	Standalone	Collocated <sup>2</sup>
AirLink LINC Node	2	9	8
	4 <sup>3</sup>	6	6
	5	7	6
	12	6	6
	13	6	6
	17 <sup>4</sup>	6	6
	26	7	6
	GSM 850	4	3
	PCS 1900	3	3

<sup>1</sup> Maximum antenna gain is 3 dBi in Japan for all channels.

<sup>2</sup> Antenna gain limit when module collocated with Wi-Fi/Wimax/BT radios.

<sup>3</sup> B4—CAT-M1 only.

<sup>4</sup> B17—CAT-NB1 only.

## 5.8 EU

ADB SAFEGATE hereby declares the ADB SAFEGATE LINC Node LN00P1 device is in compliance with the essential requirements and other relevant provisions of Directive 2014/53/EU.

The LINC Node LN00P1 displays the CE mark.



The declaration of conformity made under Directive 2014/53/EU can be accessed [here](#).



### WARNING

Changes or modifications to this device not expressly approved by ADB SAFEGATE could void the user's authority to operate this equipment.



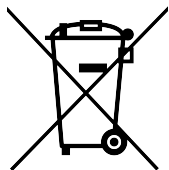
### WARNING

This product is only to be installed by qualified personnel.

## 5.8.1 Declaration of Conformity

The Declaration of Conformity made under Directive 2014/53/EU is available for viewing at [source.sierrawireless.com](http://source.sierrawireless.com).

## 5.8.2 WEEE Notice



If you purchased your ADB SAFEGATE LINC Node in Europe, please return it to your dealer or supplier at the end of its life. WEEE products may be recognized by their wheeled bin label on the product label.

## 5.9 Notice for Brazilian Users



### WARNING

This is a class A product. In a domestic environment this product may cause radio interference, in which case the user may be required to take adequate measures.

## 5.10 IMDA

Complies with IMDA Standards DA103548



## Appendix A: Support

Our experienced engineers are available for support and service at all times, 24 hour/7 days a week. They are part of a dynamic organization making sure the entire ADB SAFEGATE is committed to minimal disturbance for airport operations.

### ADB SAFEGATE Support

#### Technical Support – Global

Customers in Europe, the Middle East, Africa and Asia Pacific are more than welcome to our portal for technical support. Trained in all areas of system issues, troubleshooting, quality control and technical assistance, our highly experienced Technical support specialists are available 24 hours a day, seven days a week to provide assistance over the phone.

Europe: **+32-2-722-17-11**

China: **+86-10-8476-0106**

Middle East and Africa: **+971-4-452-7575**

In the Americas, we also offer live technical support.

#### Live Technical Support – Americas

If at any time you have a question or concern about your product, contact ADB SAFEGATE's US-based technical support specialists, available 24 hours a day, seven days a week, to assist you via phone.

ADB SAFEGATE Americas Technical Service & Support (US & Canada) :**+1-800-545-4157**

ADB SAFEGATE Americas Technical Service & Support (Canada): **+1-905-631-1597**

ADB SAFEGATE Americas Technical Service & Support (International): **+1-614-861-1304**. For technical service press 3 and for sales support press 4.

We can also be reached via email during regular business hours.

Airfield and Gate: **techservice.us@adbsafegate.com**

Gate: **gateservice.us@adbsafegate.com**

We look forward to working with you!

#### Before You Call

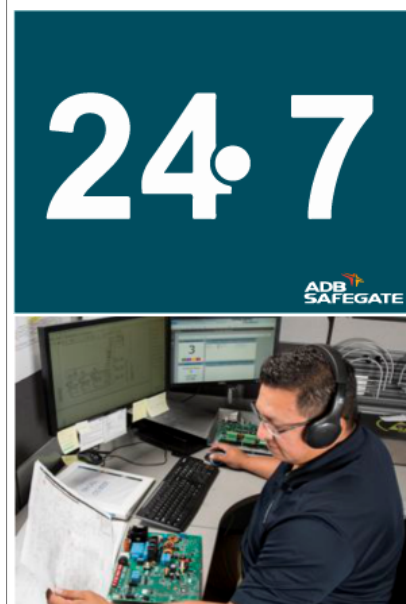
When you have an airfield lighting or control system problem, prior to calling, please ensure the following:

- Review the product's manual and troubleshooting guide.
- Be located with the product ready to troubleshoot.
- Have all necessary information available: airport code/company name, customer id number, contact phone number/email address, product/part number.
- Have all necessary tools that may be needed at hand.

When calling about an issue with Safedock A-VDGS, we can serve you better if you collect the following information before you call:

- Relevant information regarding the issue you are calling about, such as gate number, flight number, aircraft type and time of the event.
- What, if any, actions have been taken to resolve the issue prior to the call.
- If available, provide a CCTV recording of the incident to aid in aligning the information from the Safedock log file.

For more information, see [www.adbsafegate.com](http://www.adbsafegate.com), contact ADB SAFEGATE Support via email at **support@adbsafegate.com**.



## A.1 ADB SAFEGATE Website

The ADB SAFEGATE website, [www.adbsafegate.com](http://www.adbsafegate.com), offers information regarding our airport solutions, products, company, news, links, downloads, references, contacts and more.

## A.2 ADB SAFEGATE Recycling

ADB SAFEGATE is fully committed to environmentally-conscious manufacturing with strict monitoring of our own processes as well as supplier components and sub-contractor operations. ADB SAFEGATE offers a recycling program for our products to all customers worldwide, whether or not the products were sold within the European Union (EU).

ADB SAFEGATE products and/or specific electrical and electronic component parts which are fully removed/separated from any customer equipment and returned will be accepted for our recycling program.

All items returned must be clearly labeled as follows:

- For Restriction of Hazardous Substances ( *RoHS*)/Waste Electrical and Electronic Equipment (*WEEE*) Recycling
- Sender contact information (Name, Business Address, Phone number).
- Main Unit Serial Number.

ADB SAFEGATE will continue to monitor and update according for any future requirements for *EU directives* as and when *EU member states* implement new *regulations* and or *amendments*. It is our aim to maintain our *compliance plan* and assist our customers.

### A.2.1 Local Authority Recycling

The disposal of ADB SAFEGATE products is to be made at an applicable collection point for the recycling of electrical and electronic equipment. The correct disposal of equipment prevents any potential negative consequences for the environment and human health, which could otherwise be caused by inappropriate waste handling. The recycling of materials helps to conserve natural resources. For more detailed information about recycling of products, contact your local authority city office.



WWW.ADBSAFEGATE.COM

# Empowering the Airside Evolution

SMARTER. BETTER. NOW.



Copyright ©2023—2026 ADB SAFEGATE, All Rights Reserved