

SECTION

AXON INSET 8" UNIDIRECTIONAL LIGHT

Scale 1/4

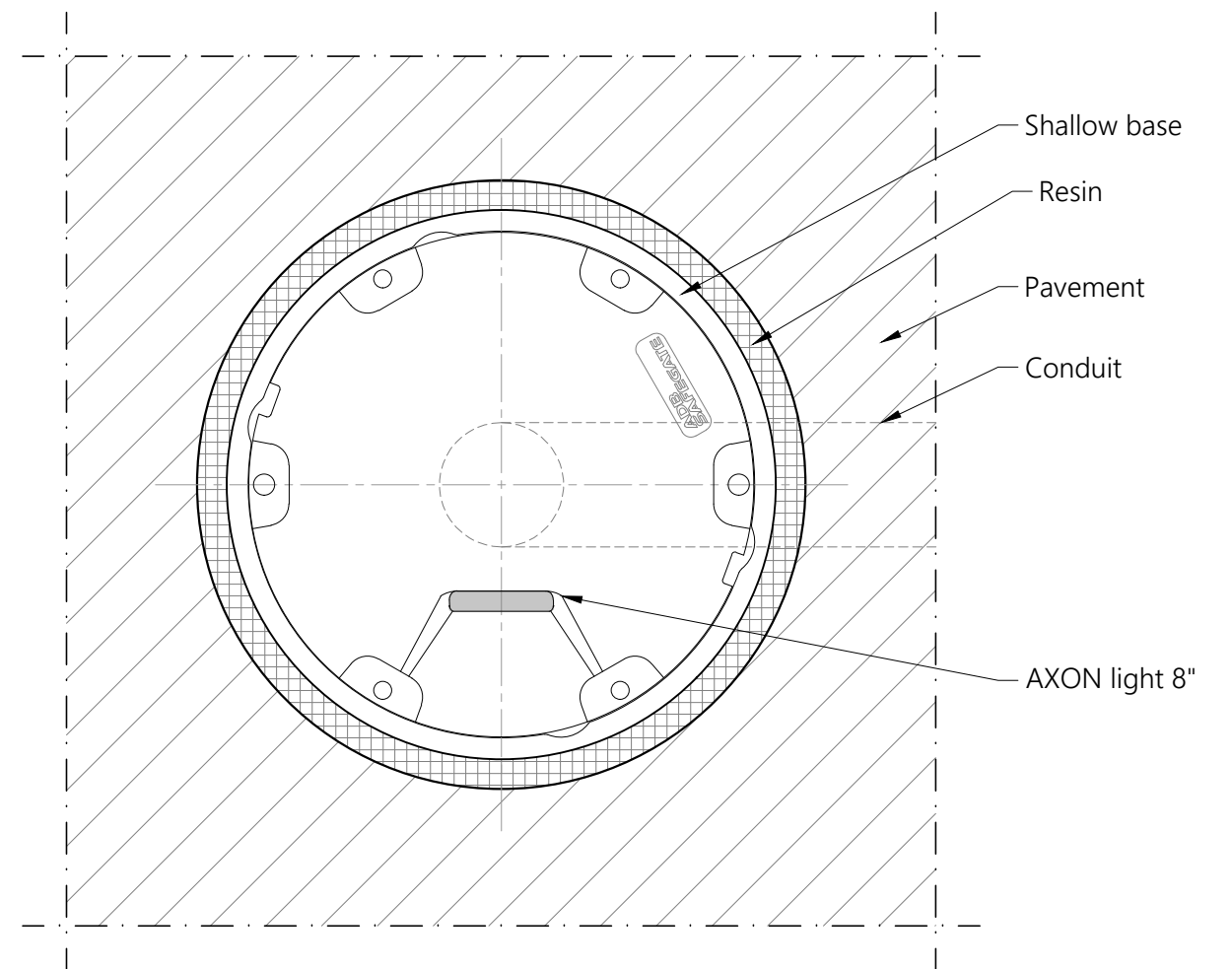

TOP VIEW

AXON INSET 8" UNIDIRECTIONAL LIGHT

Scale 1/3

NOTES:

1. This drawing shows general installation details related to ADB Safegate products and is not for construction. The designer must verify compliance of design with local standards and varying characteristics for each unique airfield project.
2. Pavement types and dimensions shown are only indicative. Installation details may vary depending on project specific pavement types and dimensions.
3. Please refer to product installation manual for installation process details.



AXON LIGHT
8 inch
INSET UNIDIRECTIONAL
TYPICAL INSTALLATION DETAILS

SCALE: AS SHOWN
DRAWN BY: JA
DATE: 14/09/2023

UNIT: mm
CHECKED BY: TH
SHEET: 1-2

ADBSG_A_AGL_AXON-I_8in_Uni_00

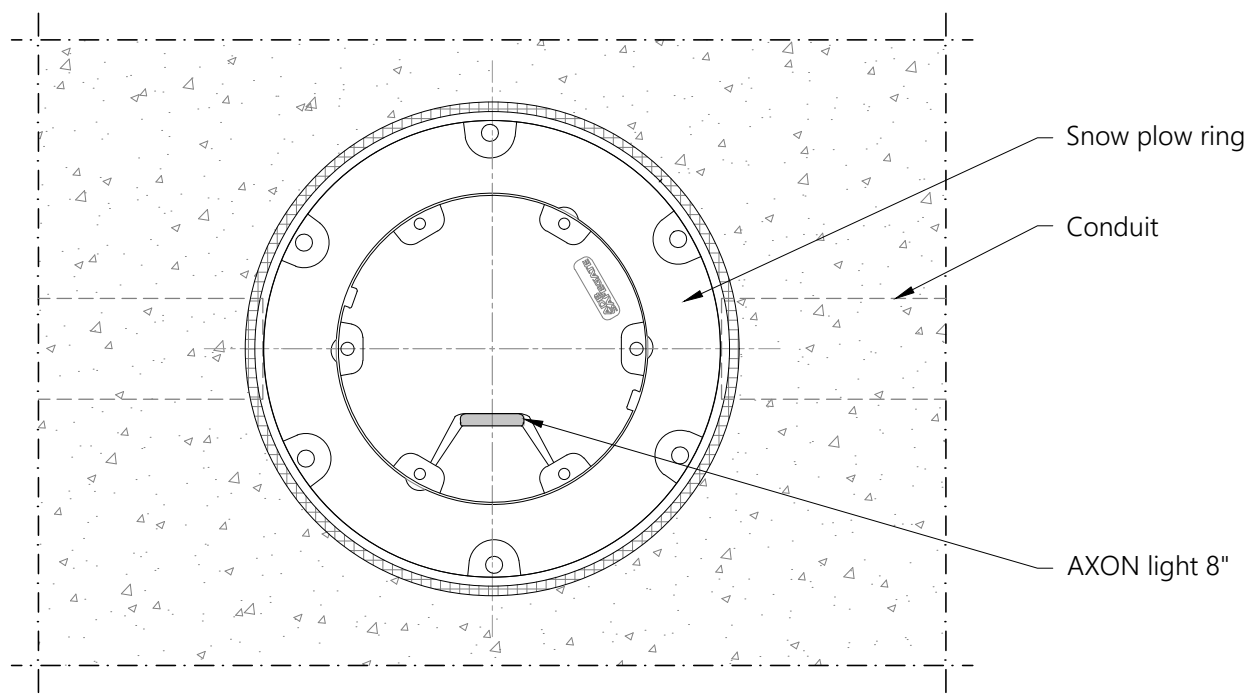

TOP VIEW
AXON INSET 8" UNIDIRECTIONAL LIGHT
 Scale 1/5

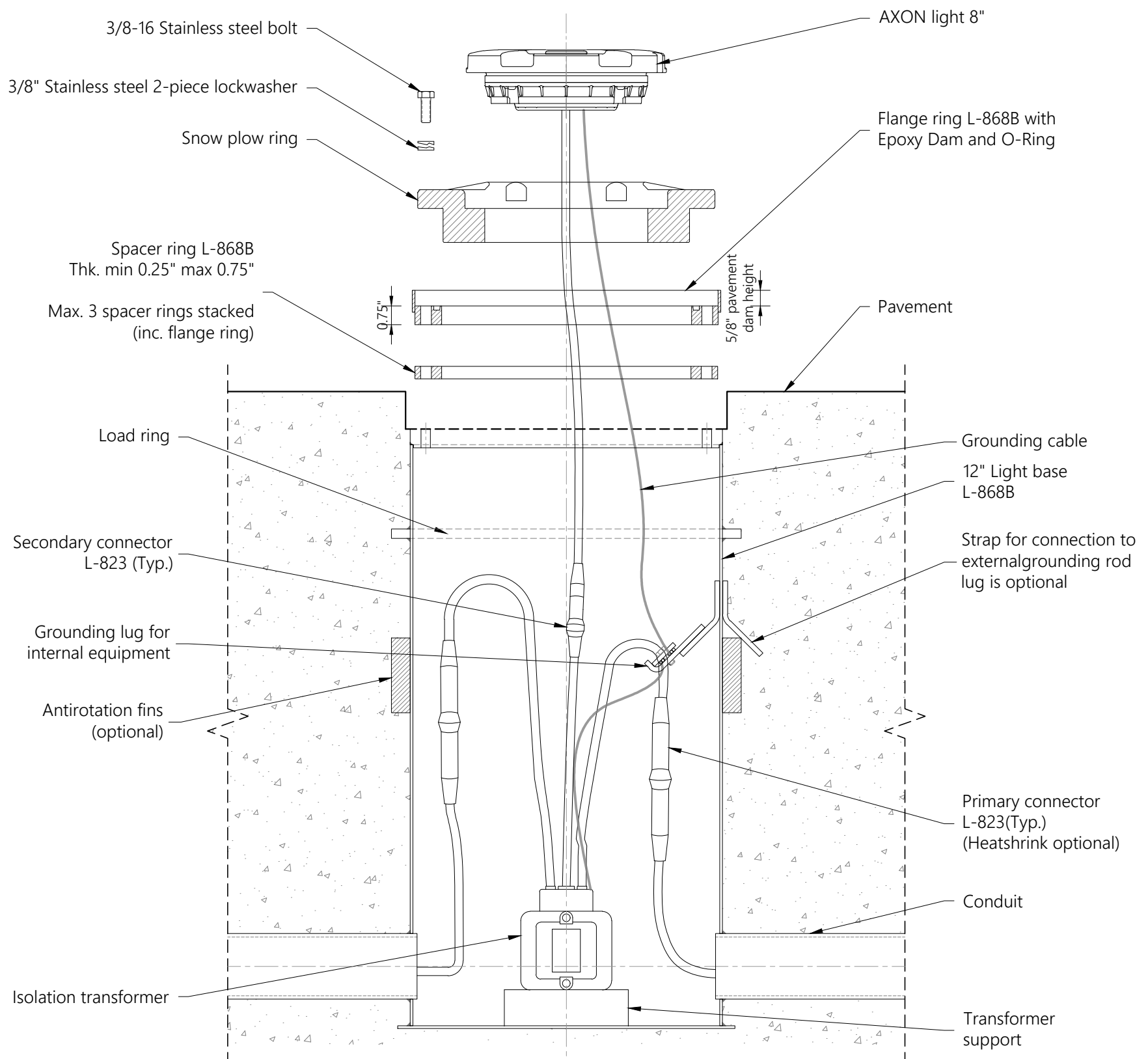

1 PIECE L-868B BASE INSTALLATION
AXON INSET 8" UNIDIRECTIONAL LIGHT
 Scale 1/5

NOTES:

1. This drawing shows general installation details related to ADB Safegate products and is not for construction. The designer must verify compliance of design with local standards and varying characteristics for each unique airfield project.
2. Pavement types and dimensions shown are only indicative. Installation details may vary depending on project specific pavement types and dimensions.
3. Please refer to product installation manual for installation process details.



AXON LIGHT
 8 inch
 INSET UNIDIRECTIONAL
 TYPICAL INSTALLATION DETAILS

SCALE: AS SHOWN
 DRAWN BY: JA
 DATE: 14/09/2023

UNIT: mm
 CHECKED BY: TH
 SHEET: 2-2

ADBSG_A_AGL_AXON-I_8in_Uni_00