



AXON LED Inset Runway Lights – 8-inch and 12-inch

Centerline, L-850A(L); Touchdown Zone, L-850B(L); Edge (45 m), L-850C(L); ICAO Edge (60 m); Guard Light, L-852G(L); Runway End, L-850D(L); FAA Threshold and Threshold/End, L-850D(L); ICAO Stopway (45 m); Takeoff/Hold and Intersection, L-850T(L); Entry, L-852S(L); ICAO Rapid Exit Taxiway Indicator; ICAO Stopway (60 m);

User Manual

UM-5055, Rev. 1.3.2, 2026-Mar-10



A.0 Disclaimer / Standard Warranty

CE certification

The equipment listed as CE certified means that the product complies with the essential requirements concerning safety and hygiene. The European directives that have been taken into consideration in the design are available on written request to ADB SAFEGATE.

ETL certification

The equipment listed as ETL certified means that the product complies with the essential requirements concerning safety and C22.2 No.180:13 (R2018) regulations. The CSA directives that have been taken into consideration in the design are available on written request to ADB SAFEGATE.

All Products Guarantee

ADB SAFEGATE will correct by repair or replacement per the applicable guarantee below, at its option, equipment or parts which fail because of mechanical, electrical or physical defects, provided that the goods have been properly handled and stored prior to installation, properly installed and properly operated after installation, and provided further that Buyer gives ADB SAFEGATE written notice of such defects after delivery of the goods to Buyer. Refer to the Safety section for more information on Material Handling Precautions and Storage precautions that must be followed.

ADB SAFEGATE reserves the right to examine goods upon which a claim is made. Said goods must be presented in the same condition as when the defect therein was discovered. ADB SAFEGATE further reserves the right to require the return of such goods to establish any claim.

ADB SAFEGATE's obligation under this guarantee is limited to making repair or replacement within a reasonable time after receipt of such written notice and does not include any other costs such as the cost of removal of defective part, installation of repaired product, labor or consequential damages of any kind, the exclusive remedy being to require such new parts to be furnished.

ADB SAFEGATE's liability under no circumstances will exceed the contract price of goods claimed to be defective. Any returns under this guarantee are to be on a transportation charges prepaid basis. For products not manufactured by, but sold by ADB SAFEGATE, warranty is limited to that extended by the original manufacturer. This is ADB SAFEGATE's sole guarantee and warranty with respect to the goods; there are no express warranties or warranties of fitness for any particular purpose or any implied warranties of fitness for any particular purpose or any implied warranties other than those made expressly herein. All such warranties being expressly disclaimed.

Standard Products Guarantee

Products manufactured by ADB SAFEGATE are guaranteed against mechanical, electrical, and physical defects (excluding lamps) which may occur during proper and normal use for a period of two years from the date of ex-works delivery, and are guaranteed to be merchantable and fit for the ordinary purposes for which such products are made.



Note

See your applicable sales agreement for a complete warranty description.

Replaced or repaired equipment under warranty falls into the warranty of the original delivery. No new warranty period is started for these replaced or repaired products.

FAA Certified products manufactured by ADB SAFEGATE

ADB SAFEGATE L858 Airfield Guidance Signs are warranted against mechanical and physical defects in design or manufacture for a period of 2 years from date of installation, per FAA AC 150/5345-44 (applicable edition).

ADB SAFEGATE LED products (with the exception of obstruction lighting) are warranted against electrical defects in design or manufacture of the LED or LED specific circuitry for a period of 4 years from date of installation, per FAA EB67 (applicable edition). These FAA certified constant current (series) powered LED products must be installed, interfaced and powered with and through products certified under the FAA Airfield Lighting Equipment Program (ALECP) to be included in this 4 (four) year warranty. This includes, but is not limited to, interface with products such as Base Cans, Isolation Transformers, Connectors, Wiring, and Constant Current Regulators.



Note

See your sales order contract for a complete warranty description.

Replaced or repaired equipment under warranty falls into the warranty of the original delivery. No new warranty period is started for these replaced or repaired products.

Liability



WARNING

Use of the equipment in ways other than described in the catalog leaflet and the manual may result in personal injury, death, or property and equipment damage. Use this equipment only as described in the manual.

ADB SAFEGATE cannot be held responsible for injuries or damages resulting from non-standard, unintended uses of its equipment. The equipment is designed and intended only for the purpose described in the manual. Uses not described in the manual are considered unintended uses and may result in serious personal injury, death or property damage.

Unintended uses, includes the following actions:

- Making changes to equipment that have not been recommended or described in this manual or using parts that are not genuine ADB SAFEGATE replacement parts or accessories.
- Failing to make sure that auxiliary equipment complies with approval agency requirements, local codes, and all applicable safety standards if not in contradiction with the general rules.
- Using materials or auxiliary equipment that are inappropriate or incompatible with your ADB SAFEGATE equipment.
- Allowing unskilled personnel to perform any task on or with the equipment.

Copyright Statement

This manual or parts thereof may not be reproduced, stored in a retrieval system, or transmitted, in any form or by any means, electronic, mechanical, photocopying, recording, nor otherwise, without the author's prior written consent.

This manual could contain technical inaccuracies or typographical errors. The author reserves the right to revise this manual from time to time in the contents thereof without obligation of the author to notify any person of such revision or change. Details and values given in this manual are average values and have been compiled with care. They are not binding, however, and the author disclaims any liability for damages or detriments suffered as a result of reliance on the information given herein or the use of products, processes or equipment to which this manual refers. No warranty is made that the use of the information or of the products, processes or equipment to which this manual refers will not infringe any third party's patents or rights. The information given does not release the buyer from making their own experiments and tests.

Table of Contents

1.0 Safety	1
1.1 Safety Messages.....	1
1.1.1 Introduction to Safety.....	2
1.1.2 Intended Use.....	2
1.1.3 Material Handling Precautions : Storage.....	3
1.1.4 Operation Safety.....	3
1.1.5 Maintenance Safety.....	3
1.1.6 Material Handling Precautions: Fasteners.....	4
1.1.7 Material Handling Precautions, ESD.....	4
2.0 About this Manual	5
2.1 How to work with the Manual.....	5
2.2 Abbreviations and Terms.....	6
3.0 Introduction	7
3.1 Product Information.....	8
3.2 Dimensions and Weight.....	12
4.0 Preparing for Installation	13
4.1 Safety Considerations.....	13
4.2 Photobiological safety.....	13
4.3 Inspect on Delivery.....	13
4.4 Unpack the Unit.....	14
4.5 Verify Input Requirements and Equipment Needed.....	14
5.0 Installation	15
5.1 Types of Bases.....	15
5.2 Installing Fixture into a Class 1 Direct-Mounted Base.....	18
5.3 Toe-in.....	20
5.4 EQ Configuration – ILCMS Remote and Sensor.....	22
5.5 RRU401.5 Remote Programming Procedure – Autonomous Runway Guard Light.....	23
6.0 Maintenance	25
6.1 Basic Maintenance Program.....	25
6.2 Recommended Maintenance Program.....	26
6.2.1 Preventive Maintenance and Regular Inspections.....	27
6.2.2 Inspection Intervals.....	28
6.2.3 Prism Cleaning.....	30
7.0 Workshop Maintenance	33
7.1 Open the Light Fixture and Disconnect the Bottom Pan from the Top Cover.....	34
7.2 Replace the Bottom Pan Assembly.....	36
7.3 Replace the Top Cover Assembly.....	36
7.4 Reset the Fail-Open Converter.....	37
7.5 Replace the Secondary Cable – SJO Cord Set.....	39
7.6 Replace the Secondary Cable – Style-6 and French 3-pin Cord Set.....	45
7.7 Replace the LED Wire Harness.....	51
7.8 Replace the Light Engine Assembly.....	52
7.9 Replace the Prism and its Gasket.....	53
7.10 Connect the Bottom Pan to the Top Cover and Close the Light Fixture.....	56
7.11 Test the Light Fixture for Leaks (Water-Tightness).....	57
8.0 Ordering Codes	59
8.1 L-850A(L) Runway Centerline and L-850B(L) Touchdown Zone.....	59
8.2 L-850C(L) Runway Edge ≤ 45 m Width Runway.....	60
8.3 ICAO Runway Edge ≤ 60 m Width Runway.....	61
8.4 L- 852(L) Runway Guard Light.....	62
8.5 FAA L-850D(L) Runway Threshold and Threshold/End; ICAO and FAA Runway End.....	63
8.6 ICAO Stopway ≤ 45 m Width Runway.....	64
8.7 RWSL: L-850T(L) Runway Takeoff/Hold and Intersection Light (THL/RIL).....	65
8.8 ICAO Rapid Exit Taxiway Indicator Light (RETIL).....	66
8.9 ICAO Stopway ≤ 60 m Width Runway.....	67

9.0 Spare Parts	69
9.1 Versions and Exploded View	69
9.2 Illustration.....	70
9.3 L-850A(L) Runway Centerline	74
9.4 ICAO and FAA L-850B(L) Touchdown Zone	78
9.5 L-850C(L) Runway Edge \leq 45 m Width Runway	81
9.6 ICAO Runway Edge \leq 60 m Width Runway	84
9.7 FAA L - 852G(L) Runway Guard Light.....	87
9.8 FAA L-850D(L) Runway Threshold and Threshold/End; ICAO and FAA Runway End.....	90
9.9 ICAO Stopway \leq 45 m Width Runway	92
9.10 RWSL L-850T(L) Runway Takeoff/Hold and Intersection Light (THL/RIL)	94
9.11 ICAO Rapid Exit Taxiway Indicator Light (RETIL).....	96
9.12 ICAO Stopway \leq 60 m Width Runway	99
10.0 Power Tables	101
A.0 INTEROPERABILITY – 12-inch and 8-inch	111
B.0 Cable Loss	115
C.0 Snow Plowing Guidelines	117
D.0 Support	121
D.1 ADB SAFEGATE Website	122
D.2 Recycling.....	123
D.2.1 Local Authority Recycling.....	123
D.2.2 ADB SAFEGATE Recycling.....	123

List of Figures

Figure 1: Fixture Dimensions	12
Figure 2: Anti-vibration washer	17
Figure 3: Prism and light beam direction	20
Figure 4: Light emissions directions	21
Figure 5: Maintenance cost graph.....	27
Figure 6: Visual inspection matrix.....	28
Figure 7: High-pressure water jet precautions.....	31
Figure 8: Pressure release screw.....	34
Figure 9: Gasket (o-ring)	35
Figure 10: 1-connector converter (2 fuse resistors)	37
Figure 11: 2-connector converter (4 fuse resistors)	37
Figure 12: 1-connector converter (2 fuse resistors)	37
Figure 13: 2-connector converter (4 fuse resistors)	37
Figure 14: 1-connector converter (2 fuse resistors)	38
Figure 15: 2-connector converter (4 fuse resistors)	38
Figure 16: SJO cord set.....	39
Figure 17: Insert tool	39
Figure 18: Releasing/locking secondary wires with insert tool	39
Figure 19: Wire tie and nylon hex nut	40
Figure 20: Cord set retainer disc and bolt (SJO jacketed cable).....	40
Figure 21: Cable clamp, bolt, washer and lock washer	41
Figure 22: Cable gland gasket.....	41
Figure 23: Cord set retainer disc and bolt (SJO jacketed cable).....	42
Figure 24: Installation of secondary cable	42
Figure 25: Wire tie and nylon hex nut	43
Figure 26: Cord set retainer disc and bolt (SJO jacketed cable).....	43
Figure 27: Cable clamp, bolt, washer and lock washer	44
Figure 28: Releasing/locking secondary wires with insert tool	44
Figure 29: Style 6 cord set	45
Figure 30: Insert tool.....	45
Figure 31: Releasing/locking secondary wires with insert tool.....	45
Figure 32: Wire tie and nylon hex nut	46
Figure 33: Cord set retainer disc and bolt	46
Figure 34: Ground wire, bolt and washer	47
Figure 35: Cable gland gasket.....	47
Figure 36: Cord set retainer disc and bolt.....	48
Figure 37: Installation of secondary cable	48
Figure 38: Wire tie and nylon hex nut	49
Figure 39: Cord set retainer disc and bolt	49
Figure 40: Ground wire, bolt and washer	50
Figure 41: Releasing/locking secondary wires with insert tool.....	50
Figure 42: LED wire harness.....	51
Figure 43: LED wire harness.....	51
Figure 44: Light engine assembly.....	52
Figure 45: Mounting sequence	52
Figure 46: Prism-keeper plate (and gap pad not visible)	53
Figure 47: Prism protection gap pad	54
Figure 48: Attaching gap pad to prism-keeper plate	54
Figure 49: Mounting procedure.....	55

Figure 50: Gasket (o-ring)	56
Figure 51: Star pattern	56
Figure 52: Pressure test fitting tool.....	57
Figure 53: Pressure release screw	57
Figure 54: Pressure test fitting tool.....	58
Figure 55: 8-inch fixtures (left) and 12-inch fixtures (right)	69
Figure 56: 12-inch and 8-inch Runway Insets	70
Figure 57: Top Cover Assembly	70
Figure 58: Bottom Pan Assembly, 8-inch	71
Figure 59: Bottom Pan Assembly, 12-inch	71
Figure 60: Bottom Pan Gasket, 8-inch, Package of 10.....	71
Figure 61: Bottom Pan Gasket, 12-inch Package of 10.....	71
Figure 62: LED Light Engines Wire Harness, Package of 10.....	72
Figure 63: Light Engine Assembly, Package of 2	72
Figure 64: Prism Kit, Package of 2	72
Figure 65: Ground Lugs, Package of 5	72
Figure 66: Style-1 Cord Set Cable Clamp, Package of 5.....	73
Figure 67: Mounting Screws, Package of 100	73
Figure 68: Pressure Release Screws, Package of 5	73
Figure 69: Arctic Kit, Package of 2	73
Figure 70: Shallow bases	113
Figure 71: Well-aligned plastic cutting edge	118
Figure 72: Signs of wear on plastic cutting edge.....	118
Figure 73: Cutting edge without clearance	118
Figure 74: Snow plow with support wheels	119

List of Tables

Table 1: 12-Inch and 8-Inch fixtures	8
Table 2: 12-Inch and 8-Inch fixtures	9
Table 3: Cross section – 12-inch – 8-inch	15
Table 4: Torque pattern.....	18
Table 5: Toe-in properties by version	20
Table 6: Maintenance tasks.....	25
Table 7: Interoperability matrix – 12-inch	111
Table 8: Interoperability matrix – 8-inch	112

1.0 Safety

Introduction to Safety







This section contains general safety instructions for installing and using ADB SAFEGATE equipment. Some safety instructions may not apply to the equipment in this manual. Task- and equipment-specific warnings are included in other sections of this manual where appropriate.

1.1 Safety Messages

HAZARD Icons used in this manual

For all HAZARD symbols in use, see the Safety section. All symbols must comply with ISO and ANSI standards.

Carefully read and observe all safety instructions in this manual, which alert you to safety hazards and conditions that may result in personal injury, death or property and equipment damage and are accompanied by the symbols shown below.

	<p>WARNING Failure to observe a warning may result in personal injury, death or equipment damage.</p>
	<p>DANGER – Risk of electrical shock or ARC FLASH Disconnect equipment from line voltage. Failure to observe this warning may result in personal injury, death, or equipment damage. ARC Flash may cause blindness, severe burns or death.</p>
	<p>WARNING – Wear personal protective equipment Failure to observe may result in serious injury.</p>
	<p>WARNING – Do not touch Failure to observe this warning may result in personal injury, death, or equipment damage.</p>
	<p>CAUTION Failure to observe a caution may result in equipment damage.</p>
	<p>ELECTROSTATIC SENSITIVE DEVICES This equipment may contain electrostatic devices.</p>

Qualified Personnel

	<p>Important Information The term qualified personnel is defined here as individuals who thoroughly understand the equipment and its safe operation, maintenance and repair. Qualified personnel are physically capable of performing the required tasks, familiar with all relevant safety rules and regulations and have been trained to safely install, operate, maintain and repair the equipment. It is the responsibility of the company operating this equipment to ensure that its personnel meet these requirements. Always use required personal protective equipment (PPE) and follow safe electrical work practice.</p>
---	--

1.1.1 Introduction to Safety



CAUTION

Unsafe Equipment Use

This equipment may contain electrostatic devices, hazardous voltages and sharp edges on components

- Read installation instructions in their entirety before starting installation.
- Become familiar with the general safety instructions in this section of the manual before installing, operating, maintaining or repairing this equipment.
- Read and carefully follow the instructions throughout this manual for performing specific tasks and working with specific equipment.
- Make this manual available to personnel installing, operating, maintaining or repairing this equipment.
- Follow all applicable safety procedures required by your company, industry standards and government or other regulatory agencies.
- Install all electrical connections to local code.
- Use only electrical wire of sufficient gauge and insulation to handle the rated current demand. All wiring must meet local codes.
- Route electrical wiring along a protected path. Make sure they will not be damaged by moving equipment.
- Protect components from damage, wear, and harsh environment conditions.
- Allow ample room for maintenance, panel accessibility, and cover removal.
- Protect equipment with safety devices as specified by applicable safety regulations
- If safety devices must be removed for installation, install them immediately after the work is completed and check them for proper functioning prior to returning power to the circuit.

Failure to follow these instructions can result in serious injury, death or equipment damage

Additional Reference Materials



Important Information

- IEC – International Standards and Conformity Assessment for all electrical, electronic and related technologies.
- IEC 60364 – Electrical Installations in Buildings.
- CSA – C22.2 No.180:13 (R2018), series isolating transformers for airport lighting.
- FAA Advisory: AC 150/5340-26 (current edition), Maintenance of Airport Visual Aid Facilities.
- Maintenance personnel must refer to the maintenance procedure described in the ICAO Airport Services Manual, Part 9.
- ANSI/NFPA 79, Electrical Standards for Metalworking Machine Tools.
- National and local electrical codes and standards.

1.1.2 Intended Use



CAUTION

Use this equipment as intended by the manufacturer

This equipment is designed to perform a specific function, do not use this equipment for other purposes

- Using this equipment in ways other than described in this manual may result in personal injury, death or property and equipment damage. Use this equipment only as described in this manual.

Failure to follow this instruction can result in serious injury or equipment damage

1.1.3 Material Handling Precautions : Storage



CAUTION

Improper Storage

Store this equipment properly

- If equipment is to be stored prior to installation, it must be protected from the weather and kept free of condensation and dust.

Failure to follow this instruction can result in equipment damage

1.1.4 Operation Safety



CAUTION

Improper Operation

Do Not Operate this equipment other than as specified by the manufacturer

- Only qualified personnel, physically capable of operating the equipment and with no impairments in their judgment or reaction times, should operate this equipment.
- Read all system component manuals before operating this equipment. A thorough understanding of system components and their operation will help you operate the system safely and efficiently.
- Before starting this equipment, check all safety interlocks, fire-detection systems, and protective devices such as panels and covers. Make sure all devices are fully functional. Do not operate the system if these devices are not working properly. Do not deactivate or bypass automatic safety interlocks or locked-out electrical disconnects or pneumatic valves.
- Protect equipment with safety devices as specified by applicable safety regulations.
- If safety devices must be removed for installation, install them immediately after the work is completed and check them for proper functioning.
- Route electrical wiring along a protected path. Make sure they will not be damaged by moving equipment.
- Never operate equipment with a known malfunction.
- Do not attempt to operate or service electrical equipment if standing water is present.
- Use this equipment only in the environments for which it is rated. Do not operate this equipment in humid, flammable, or explosive environments unless it has been rated for safe operation in these environments.
- Never touch exposed electrical connections on equipment while the power is ON.

Failure to follow these instructions can result in serious injury, death or equipment damage.

1.1.5 Maintenance Safety



DANGER

ELECTRIC SHOCK HAZARD

THIS EQUIPMENT MAY CONTAIN ELECTROSTATIC DEVICES

- DO NOT OPERATE A SYSTEM THAT CONTAINS MALFUNCTIONING COMPONENTS. IF A COMPONENT MALFUNCTIONS, TURN THE SYSTEM OFF IMMEDIATELY.
- DISCONNECT AND LOCK OUT ELECTRICAL POWER.
- ALLOW ONLY QUALIFIED PERSONNEL TO MAKE REPAIRS OR REPLACE MALFUNCTIONING COMPONENTS ACCORDING TO INSTRUCTIONS PROVIDED IN MANUAL.

FAILURE TO FOLLOW THESE INSTRUCTIONS CAN RESULT IN DEATH OR EQUIPMENT DAMAGE

1.1.6 Material Handling Precautions: Fasteners



DANGER

FOREIGN OBJECT DAMAGE - FOD

THIS EQUIPMENT MAY CONTAIN FASTENERS THAT CAN LOOSEN UNLESS TORQUED PROPERLY.

- ONLY USE FASTENERS OF THE SAME TYPE AS ORIGINALLY SUPPLIED WITH THE EQUIPMENT.
- USE OF INCORRECT COMBINATION OF GASKETS, BOLTS AND NUTS CAN CAUSE SEVERE DAMAGE TO THE PRODUCT AND CREATE MULTIPLE SAFETY RISKS .
- YOU NEED TO KNOW WHAT BASE THE LIGHT FIXTURE WILL BE INSTALLED IN, IN ORDER TO CHOOSE THE CORRECT GASKET, BOLTS AND NUTS.
- BOLT TYPE, LENGTH, AND TORQUE VALUE ARE DETERMINED BY TYPE OF BASE, HEIGHT OF SPACERS USED, AND CLAMP FORCE REQUIRED IN FAA ENGINEERING BRIEF NO 83 (LATEST REVISION).
- USE ONLY ANTI-VIBRATION WASHERS WITH THE FIXING BOLTS AS DEFINED IN FAA EB 83 (LATEST EDITION) TO AVOID THE RISK OF LOOSENING BOLTS . DO NOT USE OF ANY OTHER TYPE OF WASHER (SUCH AS SPLIT-LOCK WASHERS). FOR INSTALLATION OTHER THAN FAA, USE THE BASE CAN MANUFACTURER'S RECOMMENDATIONS.
- ALWAYS TIGHTEN THE FASTENERS TO THE RECOMMENDED TORQUE USING A CALIBRATED TORQUE WRENCH.
- APPLY THE RECOMMENDED TYPE OF ADHESIVE AND FOLLOW THE ADHESIVE INSTRUCTIONS CAREFULLY.

FAILURE TO FOLLOW THESE WARNINGS MAY CAUSE THE FASTENERS TO LOOSEN, POSSIBLY DAMAGING THE EQUIPMENT. THIS CAN LEAD TO THE HIGHLY DANGEROUS SITUATION OF FOD, WITH POTENTIALLY LETHAL CONSEQUENCES.



Note

To minimize the risk of errors, the ADB SAFEGATE Sales Representative will have information on which gasket goes with which base. This information is also provided in the product Data sheets, the User Manuals and the Spare Part Lists.

1.1.7 Material Handling Precautions, ESD



CAUTION

Electrostatic Sensitive Devices

This equipment may contain electrostatic devices

- Protect from electrostatic discharge.
- Electronic modules and components should be touched only when this is unavoidable e.g. soldering, replacement.
- Before touching any component of the cabinet you shall bring your body to the same potential as the cabinet by touching a conductive earthed part of the cabinet.
- Electronic modules or components must not be brought in contact with highly insulating materials such as plastic sheets, synthetic fiber clothing. They must be laid down on conductive surfaces.
- The tip of the soldering iron must be grounded.
- Electronic modules and components must be stored and transported in conductive packing.

Failure to follow this instruction can result in equipment damage

2.0 About this Manual

This document includes AXON runway inset light fixture information with a focus on safety, installation and maintenance procedures.

For more information, see www.adbsafegate.com.



Note

It is very important to read this document before any work is started.

This manual covers the following 12-inch and 8-inch light fixtures:

- ICAO and FAA L-850A(L) runway centerline, 12-inch and 8-inch (RC)
- ICAO and FAA L-850B(L) runway touchdown zone, 12-inch and 8-inch (RZ)
- ICAO and FAA L-850C(L) 45 m runway edge, 12-inch (RE)
- ICAO runway edge ≤ 60 m width runway, 12-inch (R6)
- ICAO and FAA L-852G(L) runway guard light, 12-inch and 8-inch (RG)
- ICAO and FAA L-850D(L) runway end, 12-inch (RN)
- FAA L-850D(L) threshold and threshold/end, 12-inch (RT)
- ICAO stopway 45 m, 12-inch (SW)
- ICAO and FAA L-850T(L) runway takeoff/hold (THL) and runway intersection (RIL), 12-inch and 8-inch (RS)
- ICAO rapid exit taxiway indicator light (RETIL), 12-inch and 8-inch (RY)
- ICAO stopway ≤ 60 m width runway, 12-inch (S6)

2.1 How to work with the Manual

- Familiarize yourself with the structure and content.
- Carry out the actions completely and in the given sequence.

2.2 Abbreviations and Terms

This document may include the abbreviations and terms listed below.

Abbreviation	Description
AGL	Airfield Ground Lighting
ANSI	American National Standards Institute
ATM	Air Traffic Movement
CCR	Constant Current Regulator
EASA	European Union Aviation Safety Agency
FAA	Federal Aviation Administration
ICAO	International Civil Aviation Organization
IEC	International Electrotechnical Committee
IEEE	Institute of Electrical and Electronics Engineers
ILCMS	Individual Light Control and Monitoring System
LED	Light Emitting Diode
NATO	North Atlantic Treaty Organization
OFDM	Orthogonal Frequency Division Multiplexing
PWM	Pulse Width Modulation
STAC	Service Technique de l'Aviation Civile (France)
STANAG	Standardization Agreement (NATO)
UFC	Unified Facilities Criteria

3.0 Introduction

The All-in-One Solution

The AXON unidirectional or bidirectional range is a 12-inch and 8-inch low-protrusion light-emitting diode (LED) inset light fixture available in different versions:

Non-MON

Basic operation, providing power only

MON (Fail-open)

Integrated fail-open technology for CCR monitoring compatibility

EQ

Integrated Intelligent Light Control and Monitor System (ILCMS) remote capability, utilizing orthogonal frequency-division multiplexing (OFDM) technology for superior communication with the LINC 360 system interface.

3.1 Product Information

Table 1: 12-Inch and 8-Inch fixtures

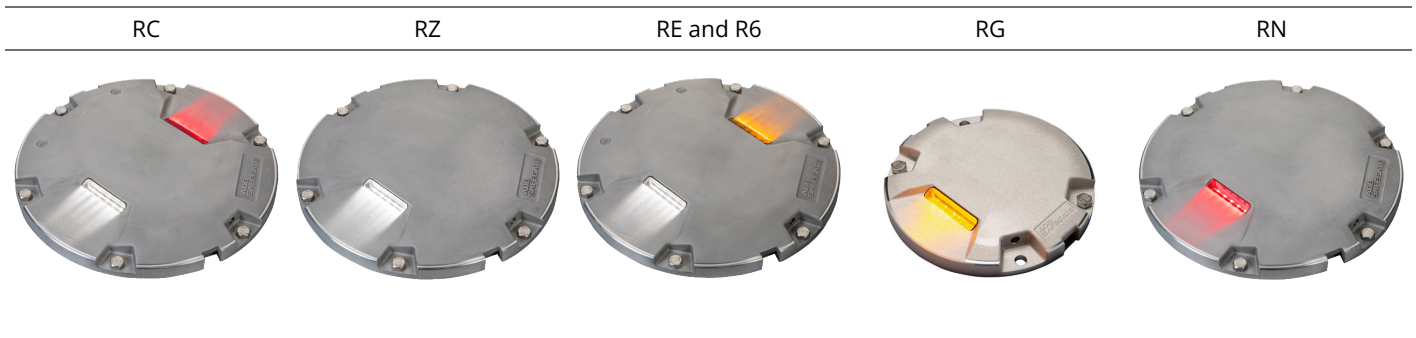

Uses

RC-RZ	RE	R6	RG	RN
<p>ICAO</p> <ul style="list-style-type: none"> Runway centerline Touchdown zone <p>FAA</p> <ul style="list-style-type: none"> L-850A(L) runway centerline L-850B(L) touchdown zone 	<p>ICAO</p> <ul style="list-style-type: none"> Runway edge ≤ 45 m width runway <p>FAA</p> <ul style="list-style-type: none"> L-850C(L) runway edge L-850C(L) displaced threshold 	<p>ICAO</p> <ul style="list-style-type: none"> Runway edge ≤ 60 m width runway 	<p>ICAO</p> <ul style="list-style-type: none"> Runway guard light <p>FAA</p> <ul style="list-style-type: none"> L-852(L) runway guard light 	<p>ICAO</p> <ul style="list-style-type: none"> Runway end Runway end/end <p>FAA</p> <ul style="list-style-type: none"> L-850D(L) runway threshold L-850D(L) runway end L-850D(L) runway threshold/end (bidirectional green and red)

Compliance and Standards

Compliance Description		RC-RZ	RE	R6	RG	RN
		DS-5040	DS-5041	DS-5042	DS-5043	DS-5044
FAA	AC 150/5345-46 and the FAA Engineering Brief No. 67	X	X		X	X
ICAO	Annex 14 Volume 1	X	X	X	X	X
EASA	CS-ADR-DSN	X	X	X	X	X
Australia	MOS 139	X	X	X	X	X
Canada	TP 312	X	X	X	X	X
IEC	61827	X	X	X	X	X
NATO	STANAG 3316	X	X	X	X	X
STAC	SPE/STAC/SE/E/VIS/6008	X	X	X	X	X
UK	CAP 168	X	X	X	X	X
CE		X	X	X	X	X

Table 2: 12-Inch and 8-Inch fixtures

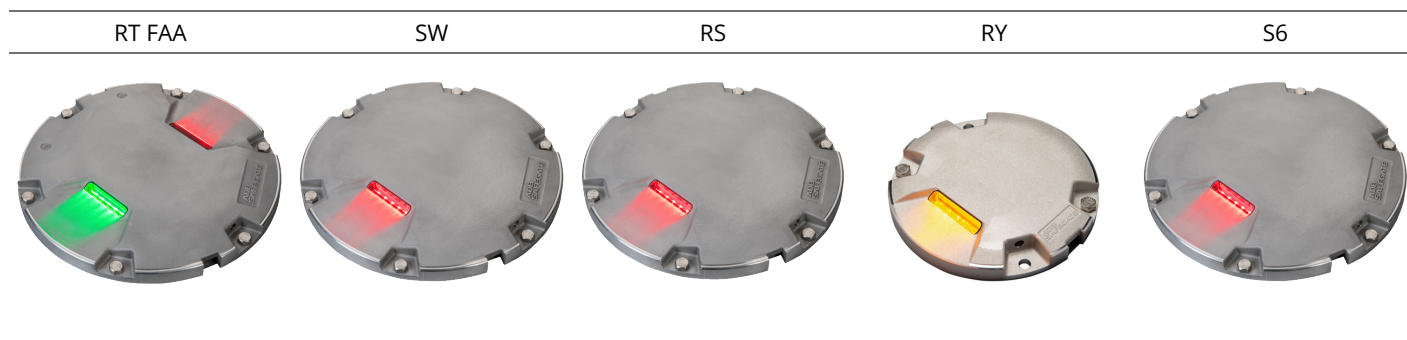

Uses

RT FAA	SW	RS	RY	S6
FAA <ul style="list-style-type: none"> L-850D(L) runway threshold L-850D(L) runway end L-850D(L) runway threshold/end (bidirectional green and red) 	ICAO and MOS <ul style="list-style-type: none"> Stopway ≤ 45 m width runway 	FAA <ul style="list-style-type: none"> L-852S(L) runway entry light (REL) L-850T(L) runway takeoff/hold and intersection light (THL/RIL) 	ICAO <ul style="list-style-type: none"> Rapid exit taxiway indicator light (RETIL) 	ICAO and MOS <ul style="list-style-type: none"> Stopway ≤ 60 m width runway

Compliance Description	RT FAA	SW	RS	RY	S6
	DS-5044	DS-5047	DS-5070	DS-5092	DS-5097
FAA AC 150/5345-46 and the FAA Engineering Brief No. 67	X		X		
ICAO Annex 14 Volume 1		X	X	X	X
EASA CS-ADR-DSN		X	X	X	X
Australia MOS 139		X		X	X
Canada TP 312		X	X	X	X
IEC 61827		X	X	X	X
NATO STANAG 3316		X	X	X	X
STAC SPE/STAC/SE/E/VIS/6008		X	X	X	X
UK CAP 168		X		X	X
CE	X	X	X	X	X

Features and Benefits

Efficiency

- EQ has an integrated ILCMS remote for use with the LINC 360 system providing high data capacity and resisting degradation from various types of radio effects to provide a superior communication platform
- Precision aimed optics enhancing photometric performance and complementing extended LED life
- Reduced bottom pan profile allowing for very shallow base can installation
- LED pulse width modulated (PWM) at 400 Hz optimizing LED performance and eliminating perceptible flicker to a moving human observer throughout the range of brightness steps
- Operates at all steps of constant current regulator technologies designed in compliance with IEC or FAA requirements
- Fully dimmable lights, conforming to the dimming curve of traditional halogen lights
- Low protrusion, high-intensity, Style 3 (≤ 6.35 mm) inset light fixtures
- No negative slope in front of the prisms

Sustainability

- Fully encapsulated all-in-one universal power supplies for Runway, Taxiway, Approach and Omni inset families
- Latest generation LEDs providing a long-lasting light source with high efficiency and low power consumption
- Reinforced top cover substantially exceeding standards to improve durability and longevity (directional beams only)
- One single family of fixtures covering all runway, taxiway and approach applications
- IP68 rated enclosure designed for harsh environments; all fastenings are stainless steel
- Reinforced prism available as an option
- Compatible with existing infrastructure allowing for direct replacement of existing LED inset fixtures

Safety

- Improved mechanical design to strengthen and consolidate components, improving the customer maintenance experience
- Fail-open option for compatibility with legacy monitoring systems and optimization of advanced control and monitoring systems
- Failed LED detection as required by Engineering Brief 67D
- Robust lightning protection complying with ANSI/IEEE C62.41-1991; Location Category C2 as required by FAA Engineering Brief 67 Category C2 is defined as a 1.2/50 μ S – 8/20 μ S combination wave, with a peak voltage of 10,000 V and a peak current of 5,000 A

Power Supply Options

- Non-monitored — power only
- Monitored — integrated fail-open technology
- EQ with integrated ILCMS with OFDM technology for use with LINC 360 system

Installation and Maintenance

The light fixture can be installed in a 12-inch or an 8-inch base. Gaskets are sold separately. Refer to the user manual INTEROPERABILITY appendix to identify the correct gasket and bolts for your specific base and ensure a reliable fit.

Operating Conditions

Operating temperature	-55 °C to +55 °C / -67 °F to +131 °F
Storage temperature	-60 °C to +80 °C / -76 °F to +176 °F
Humidity	Up to 100%

3.2 Dimensions and Weight

The weight and measurement of the light fixture depends on the version

Version	Weight	Dimension
RC/RZ – RE – R6 – RG – RN/RT FAA – SW – RS – RY – S6	6.8 kg / 15 lb (12 in)	304 mm / 12 in
RC/RZ – RG – RS – RY	3 kg / 6.6 lb (8 in)	203 mm / 8 in

Figure 1: Fixture Dimensions

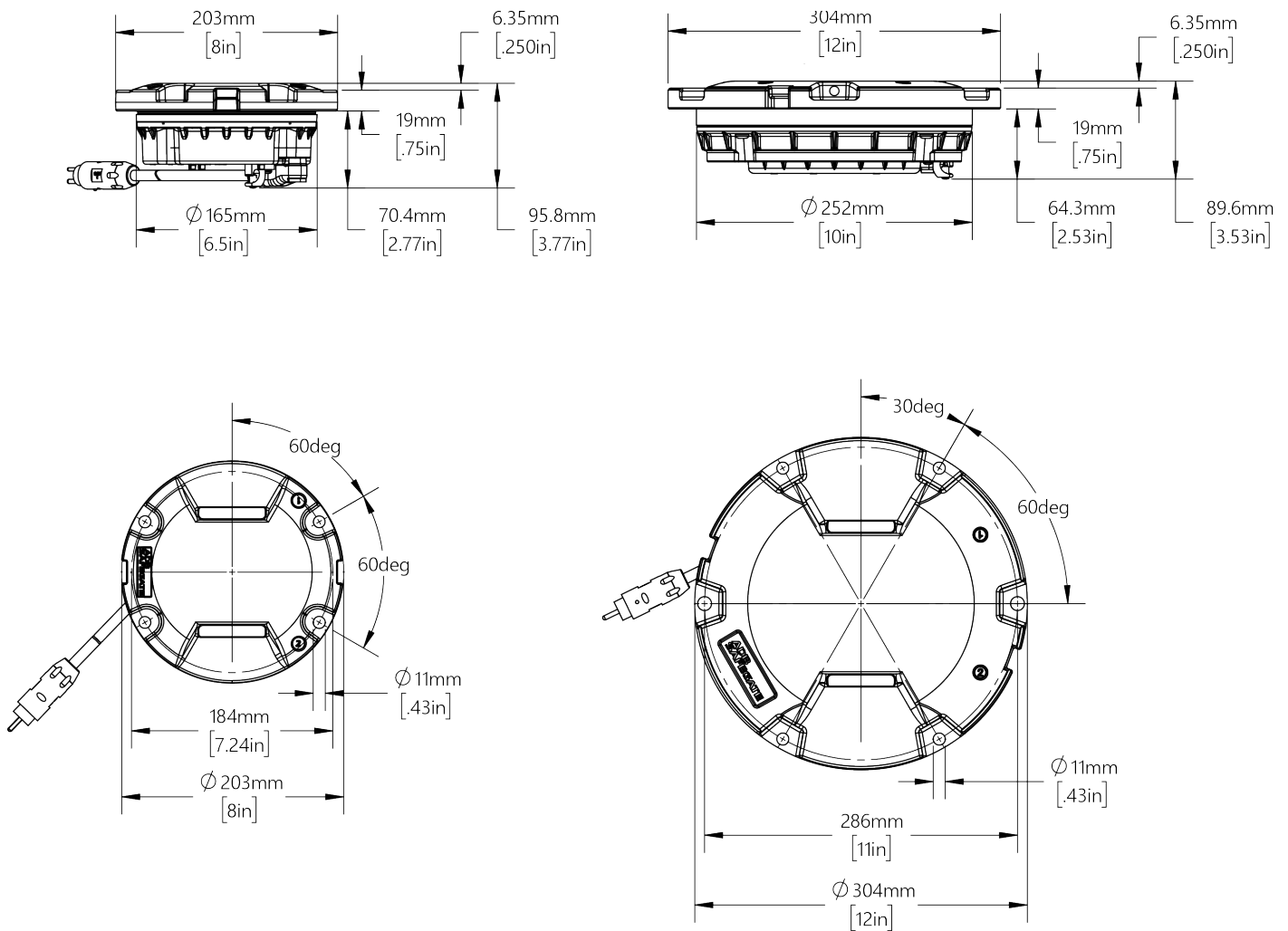

4.0 Preparing for Installation

Effective installation starts with thorough preparation and thoughtful planning. Please review this entire section before proceeding to ensure your process is seamless, safe, and optimized for long-term reliability.

4.1 Safety Considerations

- Read the installation section in its entirety before you begin installation.
- Understand the requirements of all system components. This will help you install the system safely and efficiently.
- Refer to FAA AC 150/5340-30 for design and installation details for airport visual aids.
- Use the site plans and specifications for instructions about installing runway and taxiway in-pavement lights.



DANGER

FAILURE TO FOLLOW THESE SAFETY PROCEDURES CAN RESULT IN PERSONAL INJURY OR DEATH.

- ALLOW ONLY QUALIFIED PERSONNEL TO INSTALL ADB SAFEGATE AND AUXILIARY EQUIPMENT. USE ONLY APPROVED EQUIPMENT. USING UNAPPROVED EQUIPMENT IN AN APPROVED SYSTEM MAY VOID FAA APPROVALS. OBSERVE AND FOLLOW THE SAFETY INSTRUCTIONS IN THIS DOCUMENT AND ALL OTHER RELATED DOCUMENTATION.
- MAKE SURE ALL EQUIPMENT IS RATED AND APPROVED FOR THE ENVIRONMENT WHERE IT IS BEING USED.
- FOLLOW ALL INSTRUCTIONS FOR INSTALLING COMPONENTS AND ACCESSORIES.
- INSTALL ALL ELECTRICAL CONNECTIONS IN COMPLIANCE WITH LOCAL AND NATIONAL CODES AND REGULATIONS.
- USE ONLY ELECTRICAL WIRE OF SUFFICIENT GAUGE AND INSULATION TO HANDLE THE RATED CURRENT DEMAND. ALL WIRING MUST MEET LOCAL AND NATIONAL CODES.
- ROUTE ELECTRICAL WIRING ALONG A PROTECTED PATH. MAKE SURE IT WILL NOT BE DAMAGED BY MOVING EQUIPMENT.
- PROTECT COMPONENTS FROM DAMAGE, WEAR AND HARSH ENVIRONMENTAL CONDITIONS.
- ALLOW AMPLE CLEARANCE FOR MAINTENANCE, PANEL ACCESSIBILITY AND COVER REMOVAL.
- PROTECT EQUIPMENT WITH SAFETY DEVICES AS SPECIFIED BY APPLICABLE SAFETY REGULATIONS.
- IF SAFETY DEVICES MUST BE REMOVED FOR INSTALLATION, REINSTALL THEM IMMEDIATELY AFTER THE WORK IS COMPLETED AND CHECK THEM FOR PROPER FUNCTIONING.
- THE CORD SET MUST BE PROTECTED PRIOR TO INSTALLATION.

4.2 Photobiological safety



CAUTION

Photobiological safety conforming with IEC 62471

RISK GROUP 0 or 1: Optical radiation emitted from LED lights may be harmful to the eyes. Do not stare with at the light source with bare eyes at a fixture operating at high intensity. Use protection goggles or similar protection method.

Goggles with a transmission factor not higher than 5% in the 400-530 nm band have been tested and provide adequate protection.

4.3 Inspect on Delivery

1. Inspect all packaging for visible damage.
2. If damage is detected on packaging, open the damaged box and inspect its contents for damage.
3. If containing product is damaged, immediately fill a claim form with the carrier.
4. Store the fixture in its original packing in a protected area.

4.4 Unpack the Unit



CAUTION

Do not unpack the fixture until it is at the installation site to avoid damage due to transportation and handling.

When opening the box, please confirm that the light fixture's specifications — such as type and color — align with the design requirements. If installing a fixture where control and monitoring will be activated at a later stage, make sure to register product information, such as PID/SN and position of the light fixture in, for example, a site documentation table. This information is essential for enabling remote activation and effective administration of control and monitoring from the substation.

4.5 Verify Input Requirements and Equipment Needed

The In-pavement light fixture is designed for connection to a 6.6A series lighting circuit via an L-830 (60 Hz) or L-831 (50 Hz) isolation transformer.

Make sure you have the necessary tools and materials ready for installation (not supplied). Also consider other tools that might be needed based on site-specific conditions.

5.0 Installation

This section provides instructions on how to install and remove in-pavement light fixtures. **Read the instructions in their entirety before starting installation.** Follow airport project plans and specifications for specific instructions. All work must meet the National Electric Code and local codes.

Before Installation

- Read and understand [Safety](#) and [Safety Considerations](#).
- For detailed information on compatibility with various bases and recommended torque values, refer to the [INTEROPERABILITY – 12-inch and 8-inch](#) appendix. For bases from other manufacturers, refer to their specifications. Use the correct gasket, bolts, and nuts for the base.



CAUTION

Use of incorrect combination of gaskets, bolts and nuts can cause severe damage to the product and create multiple safety risks.

5.1 Types of Bases



Note

Install the inset light fixture in a base supplied by ADB SAFEGATE, carefully following the provided instructions. If you need to install the fixture on a different base or adapter ring not supplied by ADB SAFEGATE, please contact us for guidance.

Shallow Bases – Class 1 Direct Mounted

Table 3: Cross section – 12-inch – 8-inch

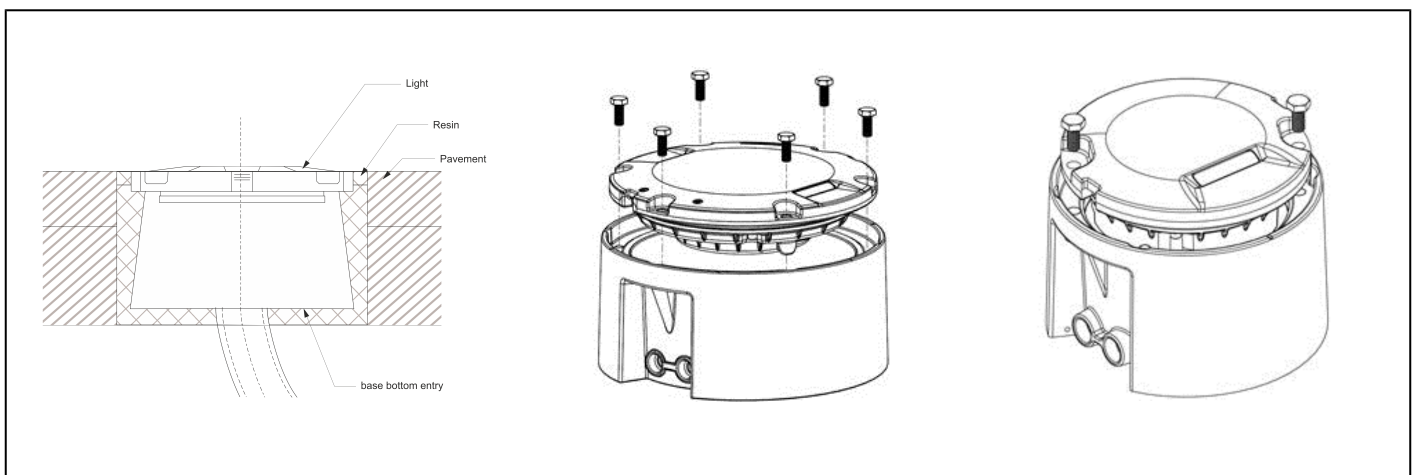

The 8-inch and 12-inch class 1, direct mounted diameter shallow base is secured in the pavement by means of resin. Correct positioning is obtained with a leveling jig with a sighting telescope. Wires between the light and the series transformer are installed either in saw cuts in the pavement filled with resin or in pipes in the lower concrete layers. Mounting an 8-inch light fixture in a 12-inch diameter base is made possible by means of dedicated adapter rings.

Steel Bases – FAA L-868B Size B

A 12-inch light fixture is installed in a 12-inch base. An 8-inch diameter light can be installed in an 8-inch base or, with the use of a snow ring or an adapter ring, in a 12-inch base. The bases are interconnected by means of conduits protecting the cables. The series transformer is installed under the light or in a separate pit. Torque according to: FAA EB-83 (latest revision).

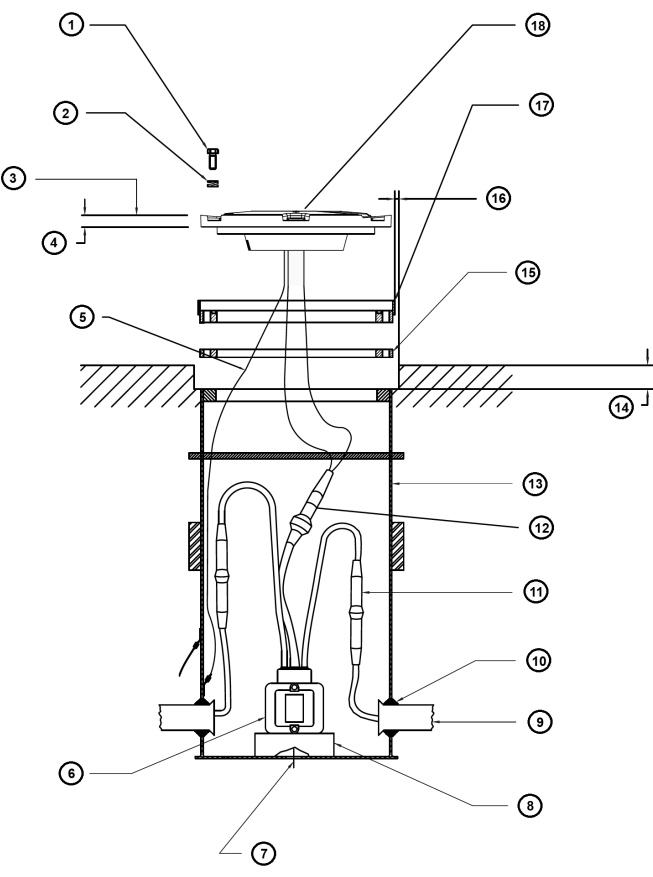
Fixture installed in a 1-piece base can	Description
	1) 3/8-16 Hex Cap Screw – per FAA EB-83 (latest revision)
	2) 3/8" Anti-vibration Washer – per FAA EB-83 (latest revision)
	3) Fixture Top Edge to be +0/ -1/16" Below Grade
	4) 0.75"
	5) Ground Wire
	6) Isolation Transformer Size as Required
	7) 3/4" Drain Hole (Centered)
	8) Transformer Support (Typ.)
	9) 2" PVC Conduit with Bell End
	10) Grommet
	11) L-823 Primary Connector (Typ.) (Heatshrink Optional)
	12) L-823 Secondary Connector
	13) L868B Light Base
	14) 1-1/2" (Typ.)
	15) L868B Spacer Ring(s)
	In order to maintain +0/ -1/16" below grade, per FAA installation tolerance, a maximum of 3 spacers may be used.
	16) 1/4" Wide X 1-1/2" Deep Groove (Typ.)
	17) L868B Flange Ring 12.25" O.D. 3/4" Thick, 5402/12Y With O-Ring Gasket (Typ.)
	18) Semi-Flush Light Fixture Type L-85X (Typ.)

Anti-Vibration Washer – Installation Requirements

- Use only the specified anti-vibration lock washers, as described in FAA AC 150/5340-30, Chapter 10, and FAA Engineering Brief No. 83 (latest revision).
- Install the lock washer correctly. The cams (or steps) of each half of the lock washer must face each other. See image below.



CAUTION

Do not use other types of washers, such as split washers. Using the wrong washer type can cause mounting bolts to loosen.

Figure 2: Anti-vibration washer

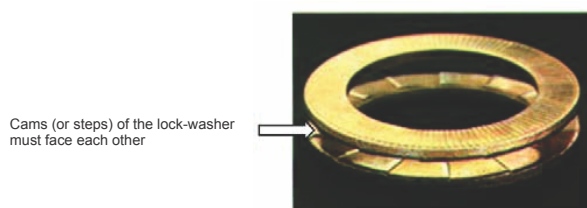

5.2 Installing Fixture into a Class 1 Direct-Mounted Base

Tools Required

The following tools are recommended for installation:

- Drill / driver with 21 mm (9/16-inch) socket
- Torque wrench with 21 mm (9/16-inch) socket (Do not use an impact wrench)
- Two large flat head screwdrivers to lift edge of fixture to reposition if necessary
- One brush or cloth
- Optional - air compressor with high pressure nozzle to assure surface is free of debris

Grounding the Fixture

If grounding the fixture, attach the braided ground strap or wire to the grounding point on the fixture using a ground lug or grounding screw and tighten to 2.5 Nm. The grounding point is marked on the bottom of the fixture.

Mounting the Fixture in the Base

- Clean all contact surfaces of the light fixture and the base.
- Put the O-ring gasket in the gasket track.



Note

For detailed information on compatibility with various bases and recommended torque values, refer to the [INTEROPERABILITY – 12-inch and 8-inch](#) appendix.

- Place the fixture into the base. Make sure the secondary cables are inside the base and not pressed between the light and the base.

Toe-in Alignment of the Fixture

See [Toe-in](#) section for toe-in properties of each fixture version.

Attaching the Fixture to the Base

Use a torque limiting box spanner (16/17 mm) or calibrated torque wrench to pre-tighten bolts to 5 Nm in the star torque patterns shown below. Continue tightening in the same star pattern until the final recommended torque value is reached. Refer to the [INTEROPERABILITY – 12-inch and 8-inch](#) appendix.



CAUTION

Do not use impact or high speed (>35 rpm) tools. Incorrect tightening can damage threads and fixture.

Table 4: Torque pattern

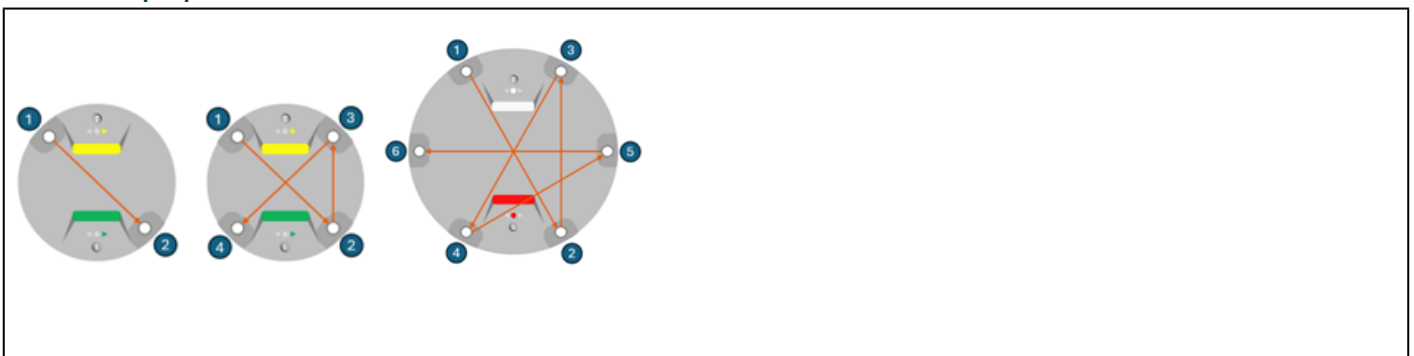

Installation Inspection and Water-Tightness Test

- Visually inspect the installation (the fixture must be evenly seated in the base).
- Make sure the bolt and washer are flush with the light fixture.
- [Test the Light Fixture for Leaks \(Water-Tightness\)](#)
- Ensure all tools and items are removed from the work area.

Post-Installation and Maintenance

After one week, the break loose torque may drop below the recommended value. This is typically due to slight settlement following installation. Perform a re-torque and visual inspection of each light fixture.

- Check for any installation issues or settlement.
- If issues are found, continue weekly inspections and investigate the cause.
- If inspection is successful, for future maintenance see [Basic Maintenance Program](#) and [Recommended Maintenance Program](#). For best results, adjust the program using local risk assessment and data analysis.

Dismounting the Fixture from Base

- Use two large flat blade screwdrivers to carefully remove the light fixture from its base.
- Disconnect the secondary power supply connector cable.
- Remove and discard the O-ring gasket and bolts. Do this every time you remove the light fixture from its base.



CAUTION

To prevent fall and trip hazards when the base is open use a cover or spare fixture.

5.3 Toe-in

Toe-in Types

Straight (no) toe-in	Fixtures with a straight light beam.
Optical (built-in) toe-in	Fixtures with a reflector that deflects the light beam at an appropriate angle. Installed in their bases facing runway/taxiway centerline .
Mechanical toe-in	Fixtures installed at an angle in their bases resulting in an angled light beam relative to the runway/taxiway. Only straight light fixtures (without toe-in) should be used.

Figure 3: Prism and light beam direction

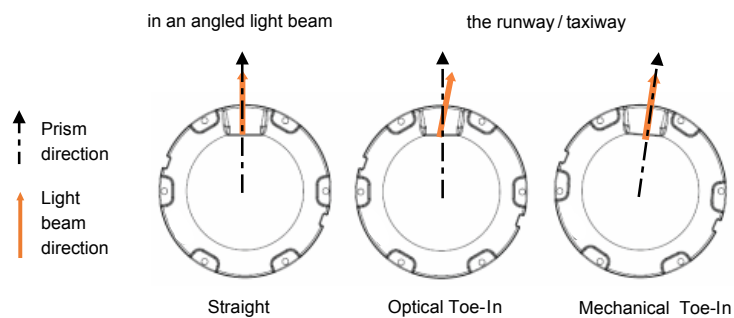

Table 5: Toe-in properties by version

Light fixture version	Options	Toe-in type
L-850A(L) - runway centerline (RC)	Straight	N/A
L-850B(L) - runway touchdown zone (RZ)	Straight or toe-in $\pm 4^\circ$	N/A or optical
L-850C(L) - runway edge ≤ 45 m width runway (RE)	Toe-in to centerline	Optical
ICAO runway edge ≤ 60 m width runway (R6)	Toe-in to centerline	Optical
ICAO & FAA L-852G(L) runway guard light (RG)	Straight	N/A
L-850D(L) - runway threshold/end runway end (RT/RN)	Toe-in $\pm 3.5^\circ$ or straight	optical or N/A
ICAO stopway ≤ 45 m width runway (SW)	Toe-in to centerline	Optical
L-850T(L) - runway status, takeoff / hold, runway intersection light (RS)	Straight	N/A
Rapid exit taxiway indicator light (RY)	Straight	N/A
ICAO stopway ≤ 60 m width runway (S6)	Toe-in to centerline	Optical

Definition of Light Emission Directions

Light fixtures that have a toe-in are marked with an arrow to ensure a correct installation with regard towards the toe-in. The light fixtures should be installed with the arrow pointing towards the centerline.

The color of the emitted light is indicated with a painted dot on the top cover in front of the prism.

Figure 4: Light emissions directions



5.4 EQ Configuration – ILCMS Remote and Sensor

To learn more about updating or configuring our EQ light fixtures equipped with internal ILCMS remote and sensor technology, please refer to our [LINC360 manuals](#). These comprehensive guides cover firmware updates, configuration options and instructions on integrating EQ lights into the ILCMS system.

5.5 RRU401.5 Remote Programming Procedure – Autonomous Runway Guard Light



Note

Only use the IR remote for unmonitored applications with no remote control device. Before starting, make sure the L-852G(L) inset is powered on and flashing.

Autonomous Flash-On/Flash-Off IR Remote - Part Number 61A0458



The autonomous version allows you to set each fixture to Flash-ON or Flash-OFF using an IR remote or a Local Programming Device. The Local Programming Device can also program variable start-up delays on longer circuits, which helps reduce load variation on a CCR powering multiple RGL bars.

1. Press and hold the "TV" key (top left) on the remote for 3 seconds. The light on the key turns on. If you do not use the remote for 20 seconds, it will exit programming mode.
2. Enter 2001 using the number keys (0-9).
 - a. If correct: The "Mode" key light turns off.
 - b. If incorrect: The "Mode" key blinks 3 times and turns off. Repeat step 1.
3. Power on the AXON Runway Guard Light (RSRG) inset you want to program.
4. Test the remote:
 - a. Hold the remote near the side 2 optical sensor window on the inset.
 - b. Make sure "TV" mode is enabled (press and release "TV").
 - c. Press and release "0" (initial flash "ON").
 - d. Press and release "cc".
 - e. The fixture flashes 4 times to confirm.
5. Press and release the "TV" key.
6. Point the IR Remote at the side 2 optical sensor window (prism) of the L-852G(L) inset. Hold the remote about 13 mm (0.5 inch) from the window at a 45° angle from the pavement.

7. Set the desired program by pressing the following keys.

Press the second key within 2 seconds after pressing the first key.

- a. Initial Flash ON: Press "0", then "CC".

The light turns on, then turns off.

- b. Initial Flash OFF: Press "2", then "CC".

The light turns off, then turns on.

- c. ON Alternative: Press "1", then "CC".

If a CCR powers only one RGL bar, set all L-852G(L) insets in that bar to "ON" (RSRG1XXX1NY1SXX1) with initial flash ON.

- d. OFF Alternative: Press "3", then "CC".

If a CCR powers more than one RGL bar, set about half of the L-852G(L) insets to "ON next OFF" (RSRG1XXX1NY0SXX1, initial flash OFF), and the other half to "alternative ON next alternative OFF" settings.

The alternative settings add a short delay. This delay helps balance the load on the CCR and reduces output current fluctuations.

8. The fixture flashes to confirm the setting:

- a. 4 flashes for "0"

- b. 2 flashes for "2"

9. The L-852G(L) inset flashes as programmed. The setting stays in memory. Repeat the procedure if needed.

6.0 Maintenance

This section describes different steps for maintenance of the light fixture. You can ensure airfield safety and visibility while maintaining the integrity and performance of the inset light fixtures by following these detailed instructions.

Before you start, make sure you have read and understand [Safety instructions](#).

Find out the location of the light unit that needs maintenance. If the purpose is to replace an existing light unit with new one, make sure that corresponding unit is available. Find the type information on the identification tag with details of name.

Spare parts are available, if required. For more information, see www.adbsafegate.com Spare Parts, or contact ADB SAFEGATE for assistance.



CAUTION

Use of incorrect combination of gaskets, bolts and nuts can create severe damages to the product installation and create multiple safety risks.

You need to know what base the light fixture will be installed in, in order to choose the correct gasket, bolts and nuts.

Failure to follow these cautions can result in equipment damage or aircraft FOD. Refer to the [INTEROPERABILITY - 12-inch and 8-inch](#) appendix.

6.1 Basic Maintenance Program

It is important to understand that even though a LED fixture requires substantially lower maintenance in regard to the replacement of the light bulbs, some parts of the light fixture remain the same and still require the same level of maintenance (prisms, top cover, bolts).

There are recommended maintenance tasks to ensure that the equipment is in correct operating condition.

Table 6: Maintenance tasks

Weekly	<ul style="list-style-type: none"> Visual inspection of the light fixture. Removal of dust from external surfaces of the light fixture.
Monthly	<ul style="list-style-type: none"> Check optical window for cleanliness, mechanical damage or moisture/condensation on the inside of the prism Check for improper torque on mounting bolts. Re-torque if needed.
Yearly	<ul style="list-style-type: none"> Detailed inspection of the light fixture Check of the body resistance, check for mechanical damage (for example cracks around the prism windows). Clean optical windows
Bi-yearly	<ul style="list-style-type: none"> Check for presence of water in mounting support by unscrewing and lifting light fixture from base and check for water ingress and corrosion. Replace gasket between light fixture and base.
After snow removal	<ul style="list-style-type: none"> Check for damaged light fixtures. Any damaged light fixtures should be replaced and brought in and properly investigated and repaired.

A daily function check is referred to in the document:

ICAO, Airport Services Manual Part 9, Airport Maintenance Practice and FAA AC 150/5340-26A, Maintenance of airport visual aids facilities.

Any issues found during maintenance tasks should be corrected accordingly and properly documented.

A proper asset management system, such as ADB SAFEGATE's [CORTEX Service](#), helps to store and document data. The system gives important information about local conditions. Use this information for preventive maintenance planning. Preventive maintenance can reduce the need for reactive maintenance. For more information visit <https://adbsafegate.com/services/airside-maintenance/>

6.2 Recommended Maintenance Program

Service Life and Inspection Intervals

All products have an expected service life. Service life is the lifetime of the product and reaching the end means that it is no longer serviceable and should be replaced.

There are several key external factors that influences the service life of a product.

- Aircraft traffic movements
- Location on the airfield
- Inspection and maintenance frequency
- Chemical usage

Air Traffic Movements (ATM)

The expected lifetime of a light fixture will be highly impacted by the traffic volume and the number of aircraft that are mechanically putting stress on the light fixtures. Airports with a higher traffic volume will have a light fixture with a shorter expected lifetime than an airport with a lower traffic volume.

The ATM can be divided into three categories for the recommendation of inspections as well as for the expected lifetime of a light fixture.¹

- 0-100k movements/year
- 100k-200k movements/year
- >200k movements/year

¹Based on ADB SAFEGATE's field experience and investigation made in close collaboration with an independent consultant and the airport team.

Location on the Airfield

The expected lifetime of a light fixture is highly dependent on the location where it is installed on an airfield. Three different areas have been defined by color categorization that are exposed to a different degree of mechanical impact. These three categories are used as a basis for the recommendation of inspections as well as for the expected lifetime of a light fixture.

- **Red** – Touch Down Area defined as 6m from either side of the runway centerline for a distance starting from 50m before the TDZ markings and extending to 200m beyond the TDZ markings as seen from the landing direction.
- **Red** – Rapid Exit Taxiway centerline lights from the runway centerline to 50m beyond the edge of the runway.
- **Amber** – All runway areas outside the Red areas.
- **Amber** – All taxiway areas outside the Red areas, including taxiway intersections for which more than 50% of the aircraft traffic turn more than 45 degrees.
- **Green** – Areas outside Red and Amber areas



NOTICE

A reliable means of recording the location history of fittings (i.e. ADB SAFEGATE's CORTEX Service) is recommended to ensure that the maximum duration in critical red areas of the runway is not exceeded.

6.2.1 Preventive Maintenance and Regular Inspections

Preventive maintenance and regular inspections will help extend the service life of the light fixture, reduce overall maintenance costs, and minimize downtime from reactive maintenance tasks.



A proper asset management system, such as ADB SAFEGATE's CORTEX Service, helps to store and document important information about local conditions. Use this information for preventive maintenance planning.

CORTEX Service is ADB SAFEGATE's digital solution for asset tracking, inspection, and maintenance. This system helps airports:

- Register airside assets.
- Schedule and track maintenance tasks electronically.
- Record inspections and maintenance activities according to ICAO and FAA standards.

CORTEX Service stores important data. It gives information about local conditions. Maintenance teams can use this information for preventive maintenance planning. This helps reduce unexpected repairs.

For more details, visit: <https://adbsafegate.com/services/airside-maintenance/>

Regular inspections and well-defined preventive maintenance planning will help to reduce the overall maintenance cost and reduce downtime from reactive maintenance tasks.

Figure 5: Maintenance cost graph

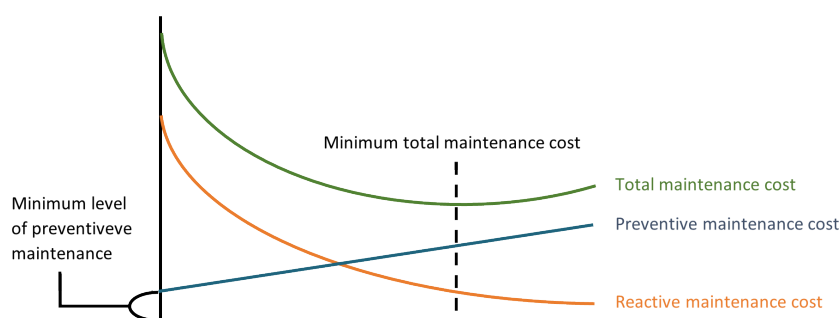

6.2.2 Inspection Intervals

Visual Inspection Checklist

To ensure dependable performance and optimize your airside operations, please visually inspect the light fixture with the following steps:

- **Prism Condition:** Confirm the prism is clean, free of cracks, and clear for optimal visibility.
- **Gasket Integrity:** Check that all gaskets are intact and show no signs of deterioration, supporting a reliable seal.
- **Moisture Check:** Ensure there is no moisture or condensation inside the prism, safeguarding against potential electrical or optical issues.
- **Corrosion Assessment:** Inspect the top cover, prism area, and bolts for any signs of corrosion. Early detection helps maintain a connected airfield and smarter, data-driven decision making.
- **Bolt Torque Verification:** Verify that all nuts and bolts are torqued according to specification, ensuring safety and long-term reliability.

Based on the air traffic volume and location on the airfield, the following matrix was created for recommended inspection intervals:

Figure 6: Visual inspection matrix

Location	RED	Amber	Green
ATM			
0-100k movements	2 Months 1 Year	6 Months 3 Years	1 Year 3 Years
100k-200k movements	2 Months 1 Year	4 Months 2 Years	1 Year 3 Years
Above 200k movements	1 Months 6 Months	2 Months 1 Year	1 Year 3 Years

Inspection interval

Detailed Inspection Checklist

To ensure reliable performance and support smarter, data-driven decision making on your airfield, please follow these steps for a comprehensive inspection:

- **Physical Inspection:** Unbolt the light fixture and carefully lift it from the base for a thorough assessment.
- **Water Ingress:** Examine both the light fixture and base, focusing on the mating surfaces, for any signs of water ingress or corrosion.
- **Corrosion:** For deep base installations (L-868), check for water accumulation. If water exceeds 6 inches, arrange for removal.
- **Damage Assessment:** Inspect both the light fixture and base for any physical damage that could impact performance.
- **Gasket Replacement:** Replace the gasket between the light fixture and base to maintain a watertight seal and dependable operation.
- **Inspection Frequency:** For aging units that have reached over 75% of their expected lifetime, we recommend halving inspection intervals to ensure continued reliability.
- **Policy Tracking:** Track and record policies in direct relation to the age of each AGL unit, supporting proactive maintenance and asset longevity.
- **Rotation of AGL in Critical Areas:** To optimize performance, rotate AGL units in critical areas as part of your maintenance program.
- **Data Recording for Asset Management:** Record location rotation and individual asset data. Keeping accurate records with a proper asset management system, such as ADB SAFEGATE's [CORTEX Service](#), empowers smarter, better decisions regarding maintenance and asset management.. For more information visit <https://adbsafegate.com/services/airside-maintenance/>



Note

Data for justification is essential when relaxing the frequency of certain maintenance tasks, such as torque management,

Expected Service Life for Critical Areas

With effective asset management — such as CORTEX Service — and a strong data capture strategy, you can adjust these guidelines to fit your local needs. The service life may change depending on your specific conditions.

The table below shows the recommended service life.

RED Zone - ATM <100k	15 years
RED Zone - ATM >100k <200K	10 years
RED Zone - ATM >200k	7 years

If you have any questions or need support, please contact your local sales representative. We are here to help you review your local conditions and create a clear maintenance plan. Together, we can optimize the service life of your investment.

6.2.3 Prism Cleaning

Regular cleaning of the prisms is crucial for maintaining light quality and fixture efficiency.

Disclaimer:

ADB SAFEGATE gives specific cleaning instructions and recommendations for its airfield light fixtures and signs. Following these guidelines helps ensure best performance and long service life.

If you use a cleaning method that is different from ADB SAFEGATE's recommendations, you do so at your own risk. ADB SAFEGATE is not responsible for any damage, reduced performance, or failure caused by improper cleaning.

Safety Precautions

1. Make sure the light fixture is turned off at the main power source to eliminate electrical hazards.
2. Use safety gloves to protect your hands and safety glasses to shield your eyes from dust and debris.

Basic Cleaning Procedure

1. Gently dust the prism with a soft, dry brush or cloth to get rid of any loose dirt or dust.
2. Remove any rubber build-up using a plastic scraper.
3. Apply lukewarm water mixed with a pH-neutral soap.
4. Thoroughly rinse off with water and dry prism with a soft, lint-free cloth to prevent water spots and ensure clear illumination.

Removing Stubborn Rubber Build-up or Compacted Snow

- Cleaning chemicals and/or de-icing liquids with a pH of 11 or less may be used in cases where pH-neutral soap is not enough. See [Approved Chemicals for Cleaning](#) and [Protocol for Introducing New Chemical Solutions](#). After applying chemicals, rinse all surfaces thoroughly with clean fresh water to remove any residue, as leftover chemicals can damage adhesives, gaskets, and other components, causing corrosion or reduced performance.



CAUTION

The extensive application of chemical cleaners and/or de-icing liquids may damage the light fixtures and underground electrical components, leading to corrosion and increased maintenance requirements and costs.

Do not use abrasive cleaners or pads that can scratch the prism surface.

Sapphire prisms, can be sensitive to certain chemicals as they are made by bonding a thin sapphire slab to a glass prism. Always test cleaning chemicals for compatibility with sapphire prisms to avoid weakening the adhesive bond. See [Protocol for Introducing New Chemical Solutions](#).

- High-pressure water jets may also be used for stubborn build-up ensuring the minimum distance of 165 mm (6.5 inches) is maintained and the water pressure does not exceed 80 bar (1300 psi) to prevent damage to the gaskets, high-pressure water jets may be employed for cleaning.

Figure 7: High-pressure water jet precautions

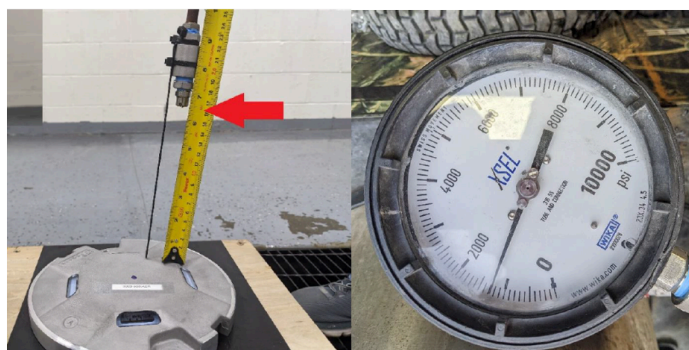

- After cleaning, gently and thoroughly dry prism with a soft, lint-free cloth to prevent water spots and ensure clear illumination.

Approved Chemicals for Cleaning

The following chemicals are tested for compatibility with ADB SAFEGATE light fixtures:

- Potassium Acetate
- Potassium Formate
- Sodium Acetate
- Sodium Formate

Protocol for Introducing New Chemical Solutions

- Verify the intended use of the chemical on similar materials and products, adhering to ADB SAFEGATE recommendations.
- Initially, conduct tests on a few units to ensure there is no damage to the light fixture or gaskets before applying the chemical to a larger installation.

7.0 Workshop Maintenance

This section gives step-by-step instructions for safe and correct workshop maintenance. The design of your light fixture may be different from the picture, depending on the application. Always follow the described work flow and use the specified torque levels.

Before you start:

- Read and understand [Safety](#) and [Safety Considerations](#).
- Remember that all maintenance that requires opening the light fixture must be done in a dedicated maintenance area.
- If you remove a light fixture from its base, cover the base or install a spare light fixture to prevent hazards.
- Only authorized personnel should disassemble fittings. This should be done with prior agreement from ADB SAFEGATE.

The workshop maintenance chapter includes the following sections:

1. [Open the light fixture and disconnect the bottom pan from the top cover](#)
2. [Replace the bottom pan assembly](#)
3. [Replace the top cover assembly](#)
4. [Reset the fail-open converter](#)
5. [Replace the secondary cable – SJO cord set](#)
6. [Replace the secondary cable – style-6 and French 3-pin cord set](#)
7. [Replace the LED wire harness](#)
8. [Replace the light engine assembly](#)
9. [Replace the prism and its gasket](#)
10. [Connect the bottom pan to the top cover and close the light fixture](#)
11. [Test the light fixture for leaks \(water-tightness\)](#)

7.1 Open the Light Fixture and Disconnect the Bottom Pan from the Top Cover

Tools and equipment to be used:

- A soft cloth big enough to cover the light fixture.
- A flat-head screwdriver
- A screwdriver or a variable-speed torque drill driver with a T30 Torx bit for 12-inch light fixture or a T25 Torx bit for an 8-inch light fixture.



ATTENTION

DO NOT use an impact driver

Procedure:

1. Put the soft cloth on a sturdy surface and place the light fixture on the cloth with the top cover facing down. (The soft cloth is to protect the top cover from scratches).
2. Remove and discard the four fixation screws.
3. Loosen the pressure release screw.

Figure 8: Pressure release screw

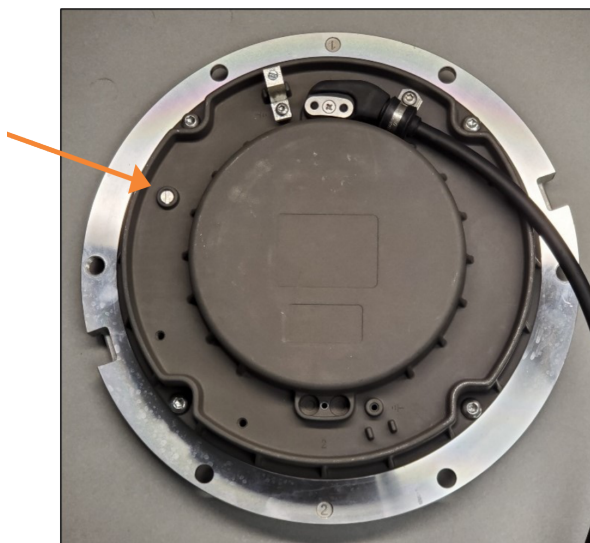

4. Lift the bottom pan carefully turning it over (converter side up). Make sure you do not damage the cables when opening the light fixture.
5. Disconnect the wires between the converter and the light engine.
6. Disconnect the wires between the converter and the arctic kit heater(s) – if applicable.

- Remove the gasket from the o-ring groove and discard.

Figure 9: Gasket (o-ring)

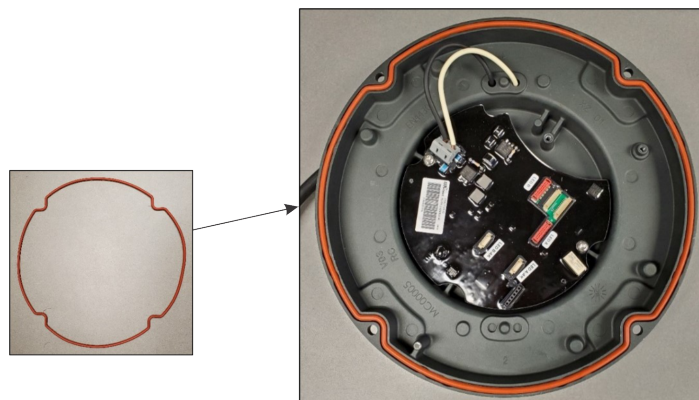

7.2 Replace the Bottom Pan Assembly

1. [Open the Light Fixture and Disconnect the Bottom Pan from the Top Cover.](#)
2. Replace the bottom pan assembly.
Make sure to **use new gasket and screws when replacing the bottom pan.**
3. [Connect the Bottom Pan to the Top Cover and Close the Light Fixture](#)

7.3 Replace the Top Cover Assembly

1. [Open the Light Fixture and Disconnect the Bottom Pan from the Top Cover.](#)
2. Remove light engine assembly. See step 2 in [Replace the Light Engine Assembly](#)
3. Replace the old top cover with a new top cover assembly.
4. Attach light engine assembly. See step 3 in [Replace the Light Engine Assembly](#)
5. [Connect the Bottom Pan to the Top Cover and Close the Light Fixture](#)

7.4 Reset the Fail-Open Converter

Parts to be used:

- Fuse resistor – new style, spare part kit: SP.EZ00015-000-01 (20 pcs)
- Fuse resistor – legacy, spare part kit: SP. 6132.00.250 (20 pcs)

Procedure:

1. Open the Light Fixture and Disconnect the Bottom Pan from the Top Cover.
2. Locate the fuse resistors

Converters – new style, in 8-inch bottom pan

Figure 10: 1-connector converter (2 fuse resistors)

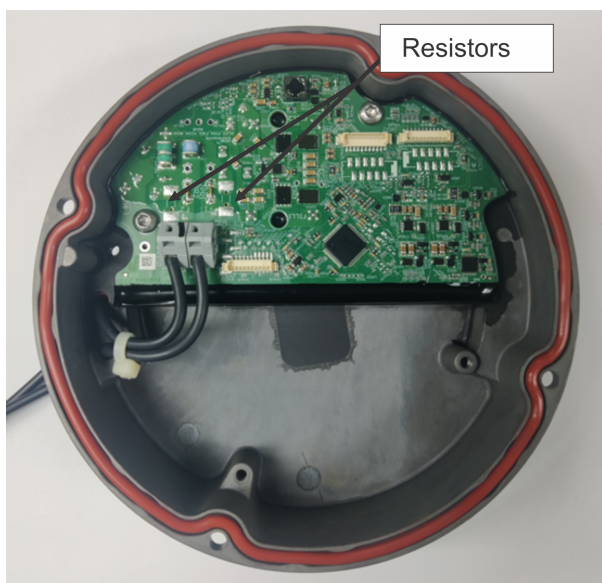
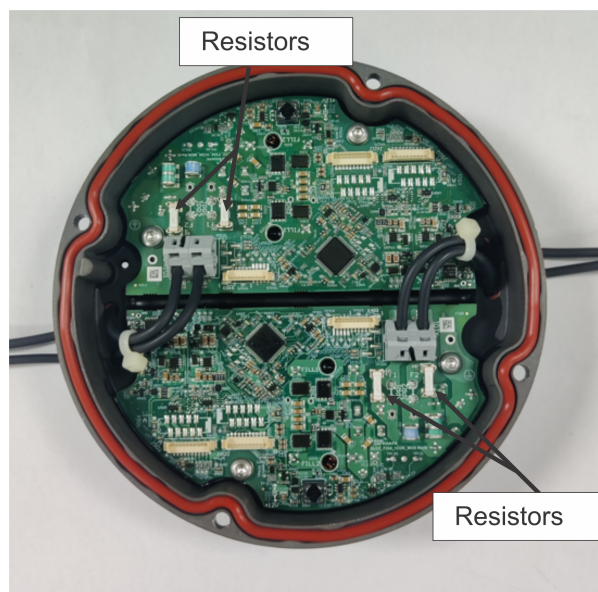

Figure 11: 2-connector converter (4 fuse resistors)



Converters – new style, in 12-inch bottom pan

Figure 12: 1-connector converter (2 fuse resistors)



Figure 13: 2-connector converter (4 fuse resistors)

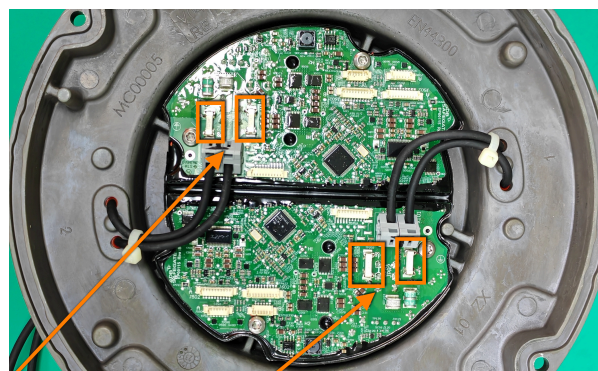

Converters – Legacy

Figure 14: 1-connector converter (2 fuse resistors)

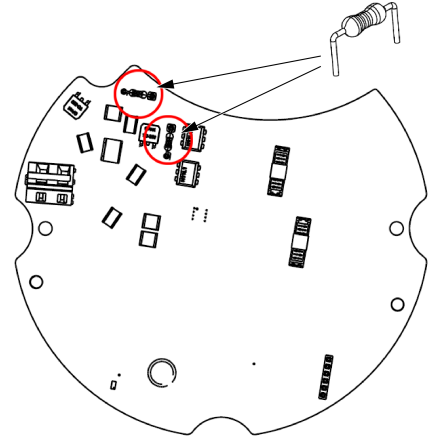
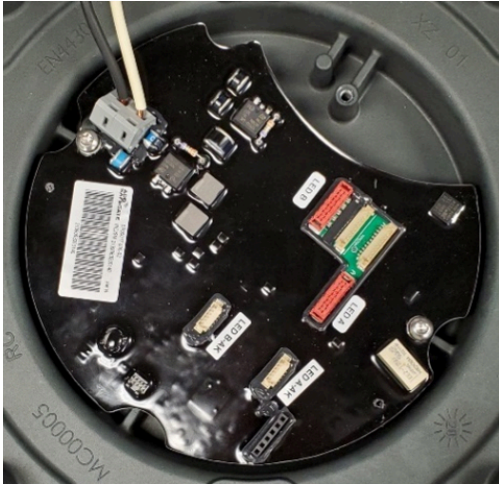
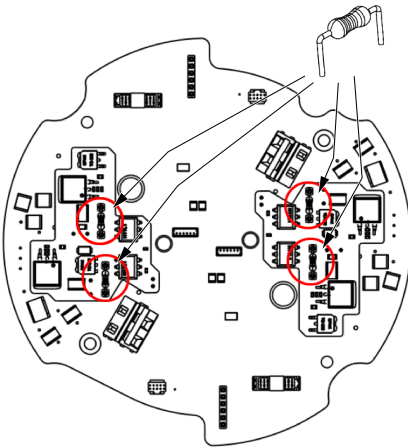

Figure 15: 2-connector converter (4 fuse resistors)



3. Gently **remove all the fuse resistors** by pulling them out of the sockets of the converter. Make sure to **dispose of the old fuse resistors**.



ATTENTION

Replace all fuse resistors at the same time.
For the 1-connector converter, replace both fuse resistors.
For the 2-connector converter, replace all four fuse resistors.

4. Gently place the new fuse resistors into the sockets of the converter.
5. [Connect the Bottom Pan to the Top Cover and Close the Light Fixture](#)

7.5 Replace the Secondary Cable – SJO Cord Set

Figure 16: SJO cord set

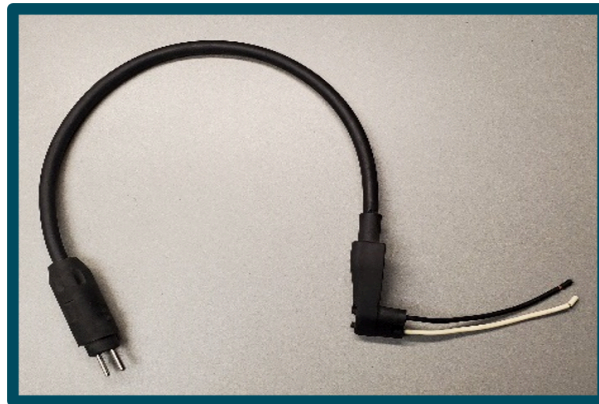

Tools to be used:

- Screwdriver or variable-speed torque drill driver with T20 Torx bit
- Small flat head screwdriver or insert tool, part no : 236-332

Figure 17: Insert tool



Procedure:

1. [Open the Light Fixture and Disconnect the Bottom Pan from the Top Cover.](#)
2. Release the secondary cable wires from the converter:
 - a. Place a small flat-head screwdriver into one of the the openings (or two of the openings with insert tool).
 - b. Gently press down on the screwdriver (or insert tool) to open the cable hole and insert/remove one of the secondary cables.
 - c. Gently release the downward pressure to lock the cable into place .
 - d. Repeat steps a-c for the other wire.

Figure 18: Releasing/locking secondary wires with insert tool

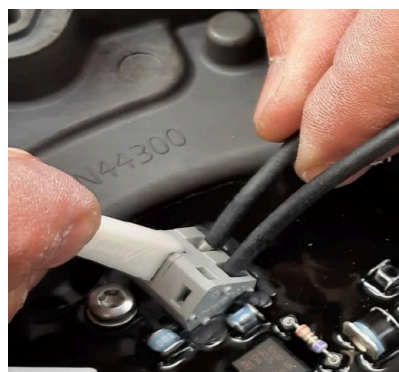

3. Cut the wire tie and remove the nylon hex nut.
Make sure to **discard the old hex nut**.

Figure 19: Wire tie and nylon hex nut

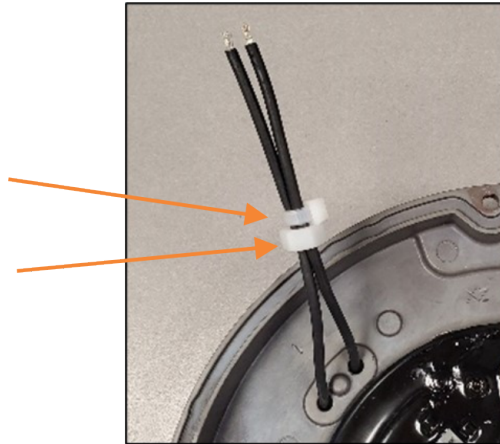

4. Flip the bottom pan converter side down and remove the bolt and cord set retainer disc.
Make sure to **discard the old bolt and cord-set retainer disc**

Figure 20: Cord set retainer disc and bolt (SJO jacketed cable)

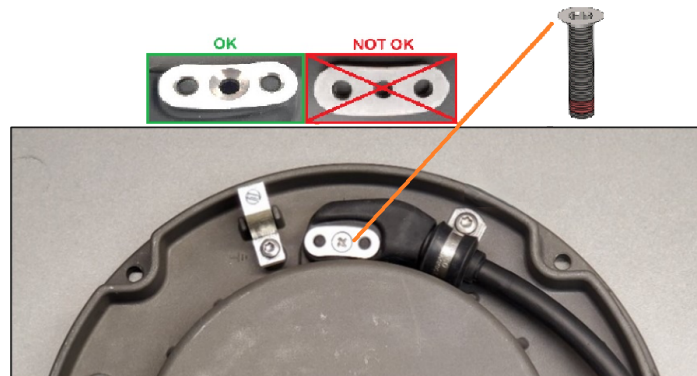

- Open the cable clamp by removing the bolt, washer and lock washer of the cable clamp. Make sure to **discard the old bolt, washer and lock washer of the cable clamp.**

Figure 21: Cable clamp, bolt, washer and lock washer



- Remove and discard the old secondary cable.
- Remove and discard the old cable gland gaskets and install new cable gland gaskets.

Figure 22: Cable gland gasket

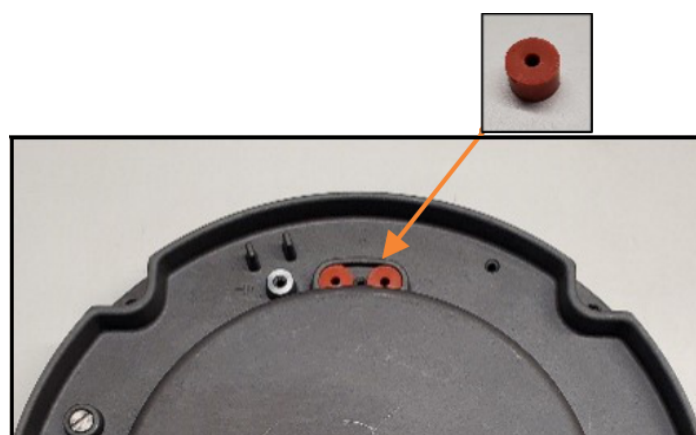

8. Install the new cord-set retainer disc and bolt (M4x10) **tightening the bolt about halfway** so the wires can move freely through the gland gaskets.

Figure 23: Cord set retainer disc and bolt (SJO jacketed cable)

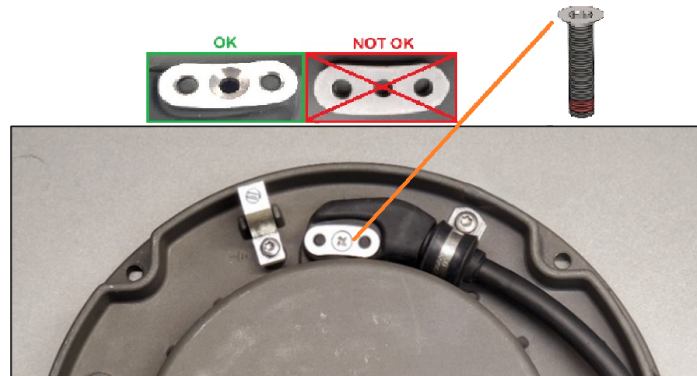

9. Insert the wires of the new secondary cable through the loosened gland gaskets feeding them through the bottom pan and flip the bottom pan converter side up. Hold the inserted cables in place while flipping so they do not exit the bottom pan.
10. Pull approximately 4 inches (100 mm) of the secondary cable through the cord set retainer disc plate. Make sure the 4-inches of the cable are on the converter side (the inside) of the bottom pan.

Figure 24: Installation of secondary cable

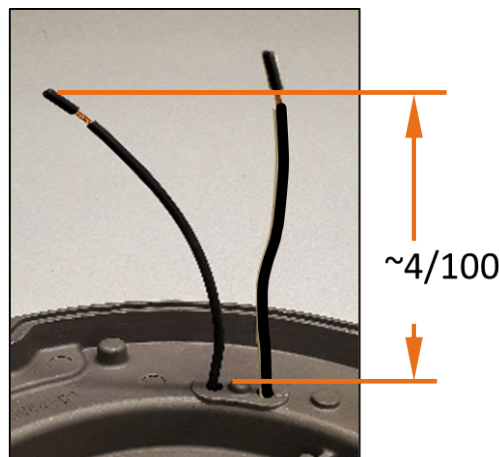

- Place the new nylon hex nut around the secondary cables and secure them tightly with a wire tie at a position of approximately 2½ inches (64 mm) from the end of the cables.

Figure 25: Wire tie and nylon hex nut

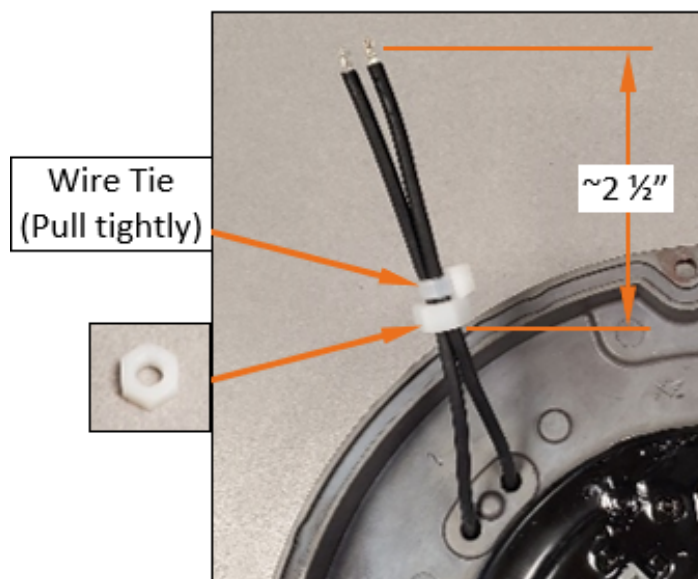

- Flip the bottom pan converter side down and tighten the new cord-set retainer bolt at 26 in-lbs (3 Nm).

Figure 26: Cord set retainer disc and bolt (SJO jacketed cable)

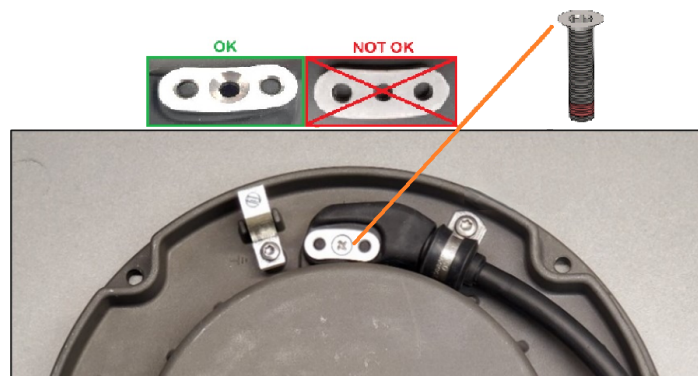

13. Inert the jacketed cable into the cable clamp and tighten the bolt, washer and lock washer of the cable clamp at 26 in-lbs (3 Nm) to fix the cable into place.

Figure 27: Cable clamp, bolt, washer and lock washer



14. Flip the bottom pan one last time and lock the secondary cables into the converter:
 - a. Place a small flat-head screwdriver into one of the the openings (or two of the openings with insert tool).
 - b. Gently press down on the screwdriver (or insert tool) to open the cable hole and insert/remove one of the secondary cables.
 - c. Gently release the downward pressure to lock the cable into place .
 - d. Repeat steps a-c for the other wire.

Figure 28: Releasing/locking secondary wires with insert tool

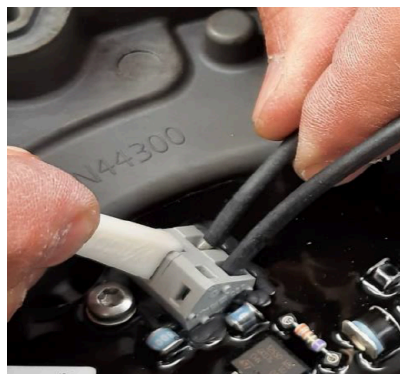

15. [Connect the Bottom Pan to the Top Cover and Close the Light Fixture](#)

7.6 Replace the Secondary Cable – Style-6 and French 3-pin Cord Set

Figure 29: Style 6 cord set



Tools to be used:

- Screwdriver or variable-speed torque drill driver with T20 Torx bit
- Small flat head screwdriver or insert tool, part no : 236-332

Figure 30: Insert tool



Procedure:

1. [Open the Light Fixture and Disconnect the Bottom Pan from the Top Cover.](#)
2. Release the secondary cable wires from the converter:
 - a. Place a small flat-head screwdriver into one of the the openings (or two of the openings with insert tool).
 - b. Gently press down on the screwdriver (or insert tool) to open the cable hole and insert/remove one of the secondary cables.
 - c. Gently release the downward pressure to lock the cable into place .
 - d. Repeat steps a-c for the other wire.

Figure 31: Releasing/locking secondary wires with insert tool

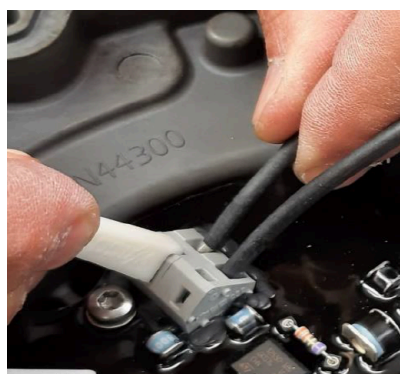

3. Cut the wire tie and remove the nylon hex nut.
Make sure to **discard the old hex nut**.

Figure 32: Wire tie and nylon hex nut

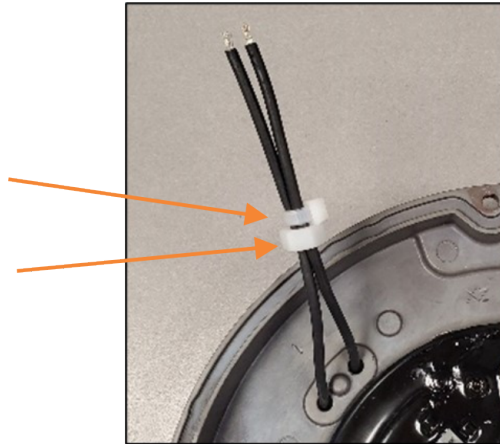

4. Flip the bottom pan converter side down and remove the bolt and cord set retainer disc.
Make sure to **discard the old bolt and cord-set retainer disc**

Figure 33: Cord set retainer disc and bolt

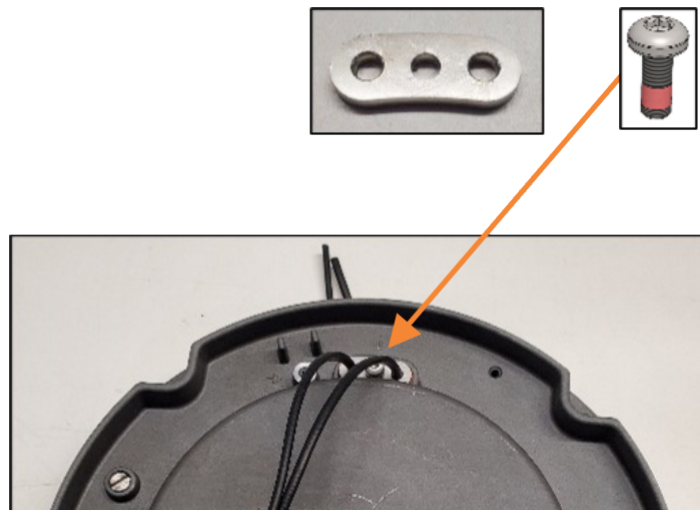

5. Disconnect the ground wire from the bottom pan and discard the bolt and washer.
Bolt and washer ordered separately as "Grounding kit Style 6".

Figure 34: Ground wire, bolt and washer

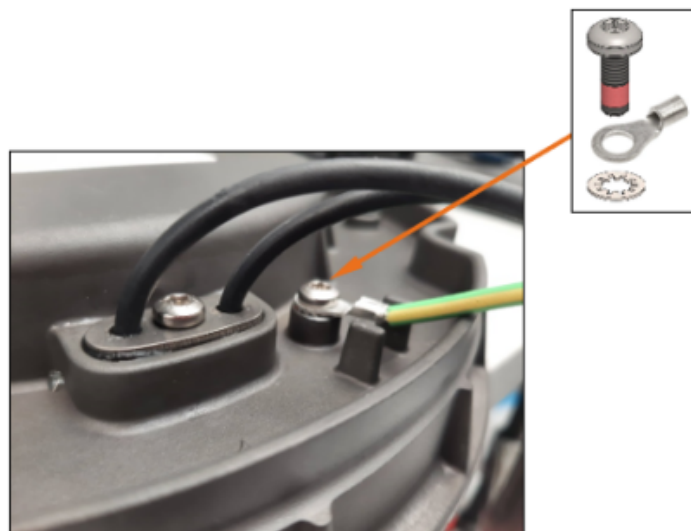

6. Remove and discard the old secondary cable.
7. Remove and discard the old cable gland gaskets and install new cable gland gaskets.

Figure 35: Cable gland gasket

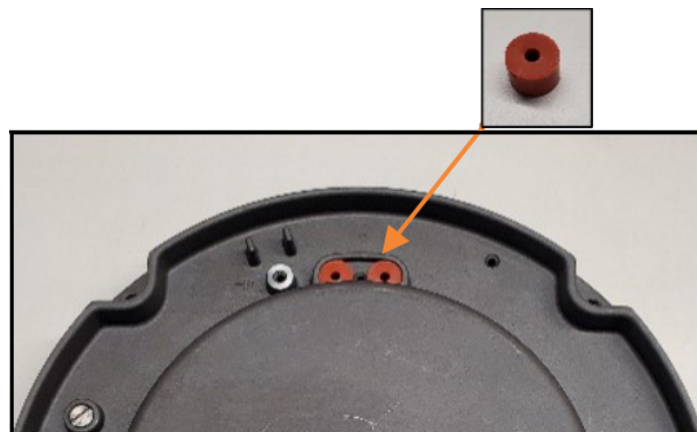

8. Install the new cord-set retainer disc and bolt (M4x10) **tightening the bolt about halfway** so the wires can move freely through the gland gaskets.

Figure 36: Cord set retainer disc and bolt

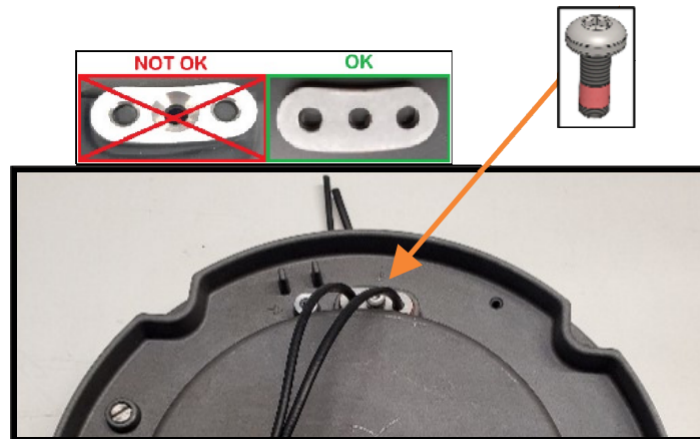

9. Insert the wires of the new secondary cable through the loosened gland gaskets feeding them through the bottom pan and flip the bottom pan converter side up. Hold the inserted cables in place while flipping so they do not exit the bottom pan.
10. Pull approximately 4 inches (100 mm) of the secondary cable through the cord set retainer disc plate. Make sure the 4-inches of the cable are on the converter side (the inside) of the bottom pan.

Figure 37: Installation of secondary cable

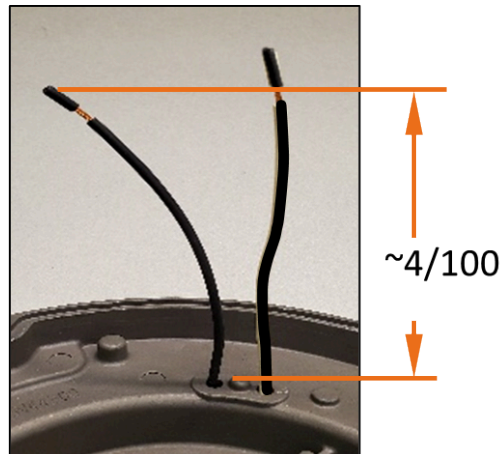

- Place the new nylon hex nut around the secondary cables and secure them tightly with a wire tie at a position of approximately 2½ inches (64 mm) from the end of the cables.

Figure 38: Wire tie and nylon hex nut

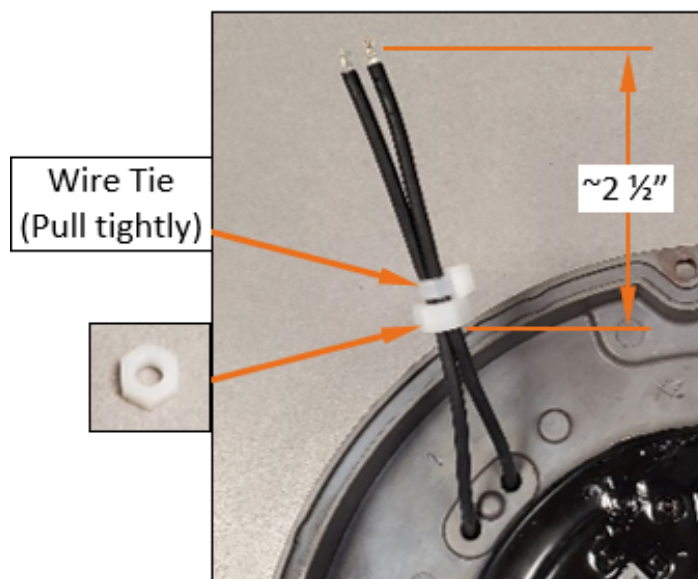

- Flip the bottom pan converter side down and tighten the new cord-set retainer bolt at 22 in-lbs (2.5 Nm).

Figure 39: Cord set retainer disc and bolt

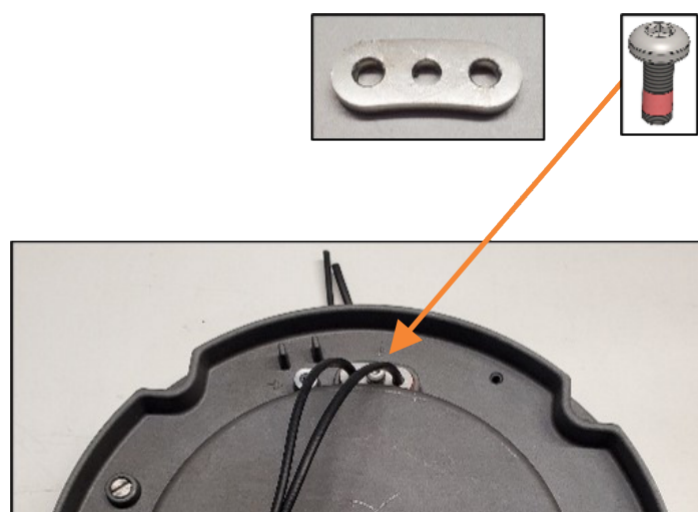

13. Connect the ground wire to the bottom pan and tighten the bolt and washer at 22 in-lbs (2.5 Nm). Bolt and washer ordered separately as "Grounding kit Style 6".

Figure 40: Ground wire, bolt and washer

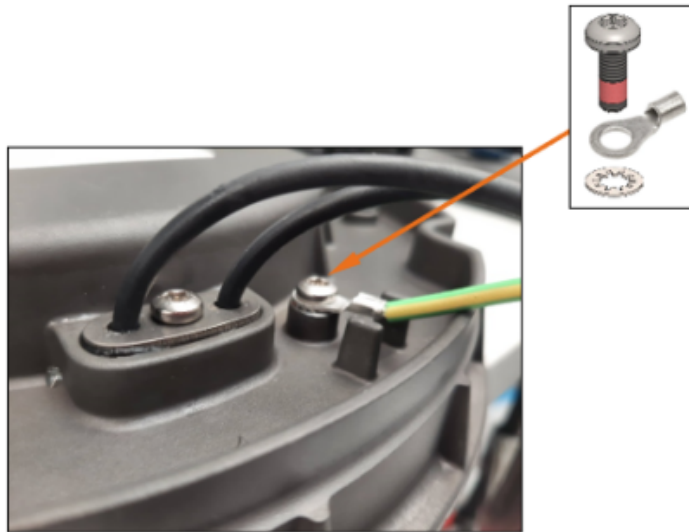

14. Flip the bottom pan one last time and lock the secondary cables into the converter:
 - a. Place a small flat-head screwdriver into one of the the openings (or two of the openings with insert tool).
 - b. Gently press down on the screwdriver (or insert tool) to open the cable hole and insert/remove one of the secondary cables.
 - c. Gently release the downward pressure to lock the cable into place .
 - d. Repeat steps a-c for the other wire.

Figure 41: Releasing/locking secondary wires with insert tool

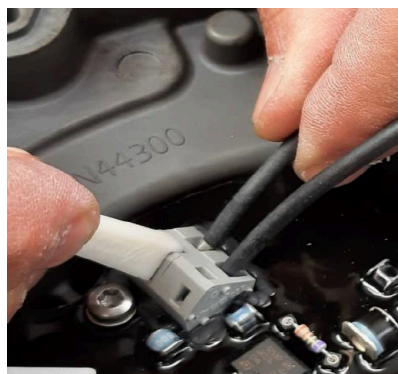

15. [Connect the Bottom Pan to the Top Cover and Close the Light Fixture](#)

7.7 Replace the LED Wire Harness



Note

Replacement light engine assemblies come with the power wire harness already attached.



ATTENTION

DO NOT use an impact driver

Figure 42: LED wire harness



Procedure:

1. Open the Light Fixture and Disconnect the Bottom Pan from the Top Cover.
2. Disconnect the wire harness and remove the old wire harness.
Make sure to **dispose of the old wire harness**.

Figure 43: LED wire harness

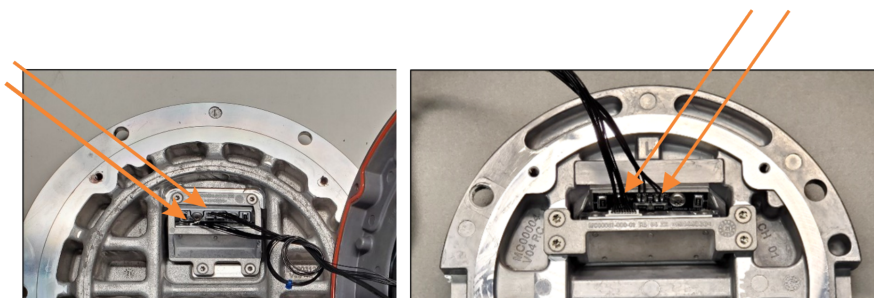

3. Connect the new wire harness to the top cover ensuring the direction of the connector is correct to avoid damaging pins.
4. Connect the Bottom Pan to the Top Cover and Close the Light Fixture

7.8 Replace the Light Engine Assembly



Note

- The blue protection spacers (gaps/plates) and gasket provided on delivery are intended only for transportation protection — please discard them and use the new spacers and gasket for installation
- Replacement light engine assemblies come with the power wire harness already attached
- Replace all light engines at the same time whenever one is replaced for optimal performance and reliability

Tools to be used:

- Screwdriver or variable-speed torque drill driver with a T20 Torx bit.



ATTENTION

DO NOT use an impact driver

Procedure:

1. [Open the Light Fixture and Disconnect the Bottom Pan from the Top Cover.](#)
2. Remove the four M4 screws from the light engine assembly and remove the light engine assembly from the fixture. Make sure to **dispose of the old screws.**

Figure 44: Light engine assembly

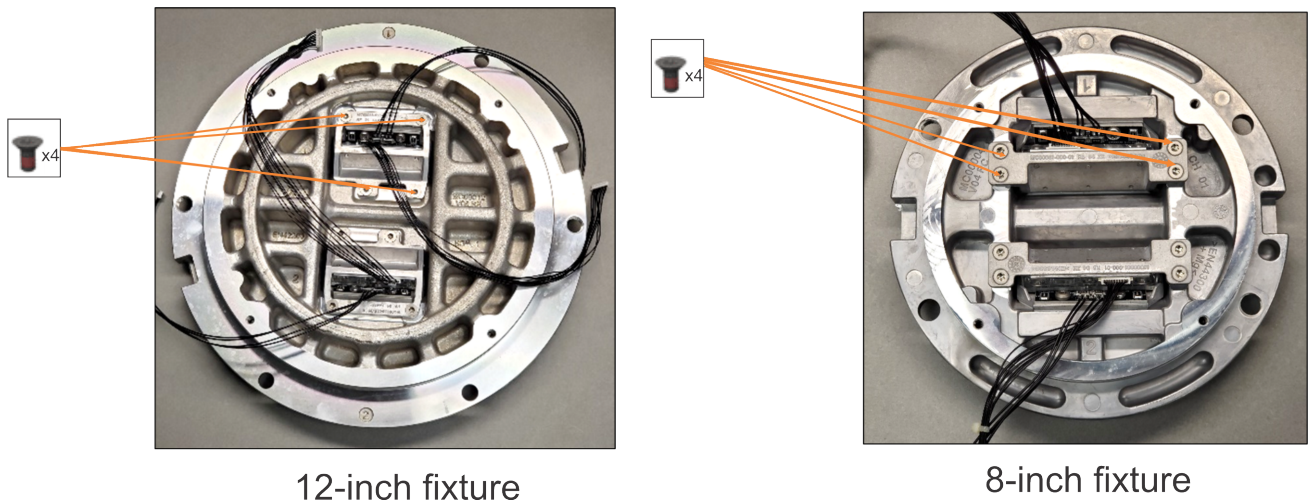

3. Attach the light engine assembly onto the top cover with four new M4x10 screws at 26 in-lbs (3 Nm). Make sure you tighten the screws in the correct order (refer to the image below).

Figure 45: Mounting sequence

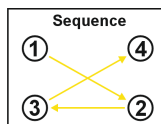

4. [Connect the Bottom Pan to the Top Cover and Close the Light Fixture](#)

7.9 Replace the Prism and its Gasket



IMPORTANT

Replace all prisms if you replace any single prism. Prisms must be replaced if there is water in the fixture or if any prism is cracked.

Tools to be used:

- Screwdriver or variable-speed torque drill driver with T20 Torx bit.



ATTENTION

DO NOT use an impact driver

Procedure:

1. [Open the Light Fixture and Disconnect the Bottom Pan from the Top Cover.](#)
2. Remove light engine assembly. See step 2 in [Replace the Light Engine Assembly](#)
3. Unscrew the four M4x10 screws from the prism-keeper plate. Unscrew the two M4x8 screws from the prism-protection gap pad. Remove the prism-keeper plate and the prism-protection gap pad from the fixture.

Figure 46: Prism-keeper plate (and gap pad not visible)

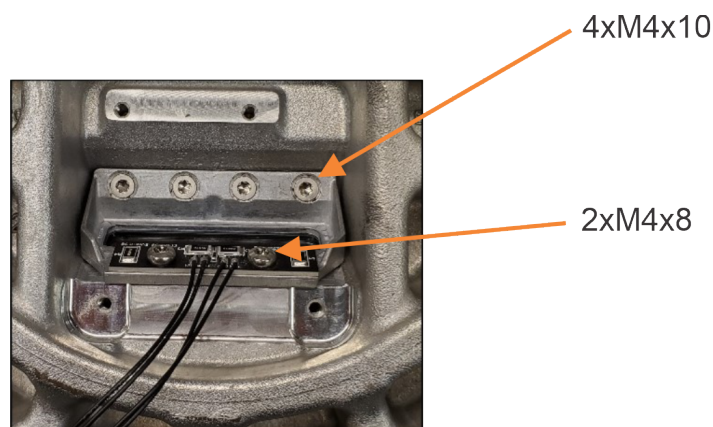

4. Remove the prism and the prism gasket by pushing from the outside (under the top cover) and clean the prism cavity.
Make sure to **dispose of the old prism and gasket.**
5. Install a new prism gasket into the prism cavity of the top cover.
Make sure the longer slanted part of the gasket is facing the center of the fixture.
6. Press a new prism into the prism gasket. Keep applying pressure for a few seconds until the prism is in place.
Clean the prism surfaces with a clean rag or wipe to remove any fingerprints.

7. Place the prism protection gap pad on top of the prism.

Figure 47: Prism protection gap pad

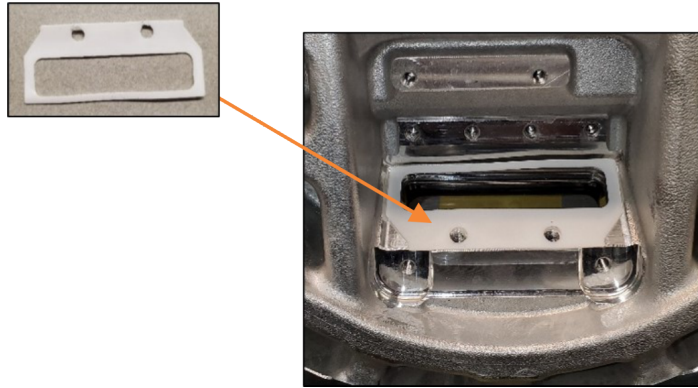

8. Place the prism-keeper plate over the protection gap pad, aligning the screw holes.
If a heater is included, install it between the protection gap pad and the prism-keeper plate.
Attach the gap pad (and heater, if applicable) to the prism protection plate using two M4x8 screws tightened to 26 in-lbs (3 Nm).

Figure 48: Attaching gap pad to prism-keeper plate

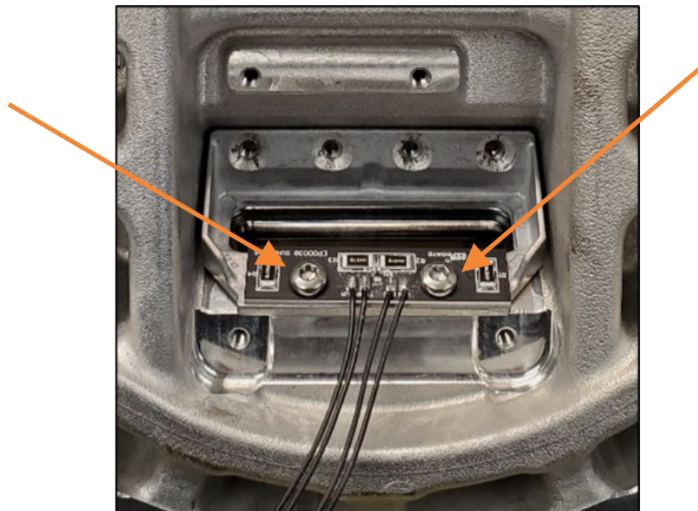

9. Attach the prism-keeper plate to the top cover with four M4x10 screws at 26 in-lbs (3 Nm). Make sure you tighten the screws in the correct order (refer to the image below).

Figure 49: Mounting procedure

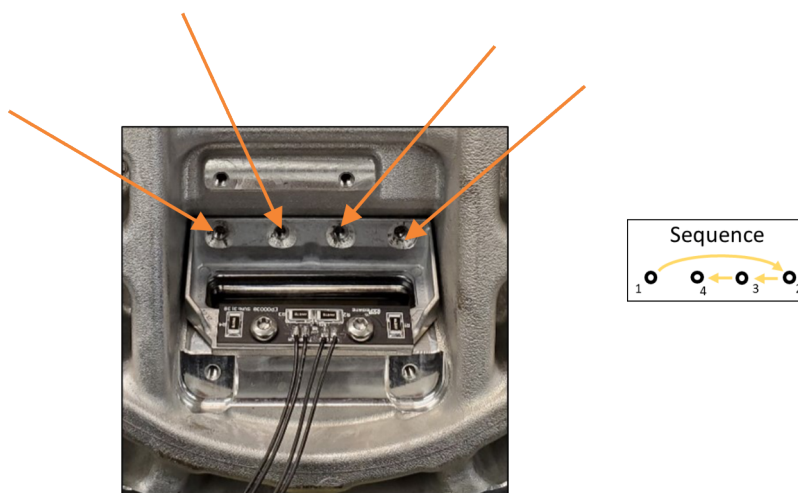

10. Attach light engine assembly. See step 3 in [Replace the Light Engine Assembly](#)
11. [Connect the Bottom Pan to the Top Cover and Close the Light Fixture](#)

7.10 Connect the Bottom Pan to the Top Cover and Close the Light Fixture

1. Clean all the contact surfaces and housing of the light fixture carefully.
2. Press a new gasket into the o-ring groove and make sure it is seated correctly.



IMPORTANT

The o-ring gasket must always be changed when the fixture is disassembled.

Figure 50: Gasket (o-ring)

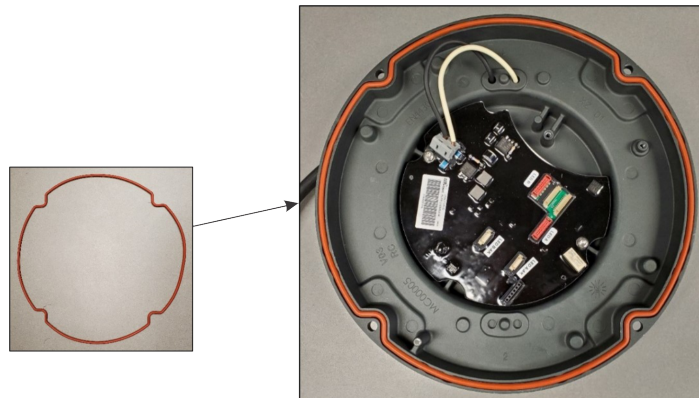

3. Connect the wire between the converter and the light engine.
4. Connect the wire between the converter and the arctic kit heater – if applicable.
5. Turn the top cover over (converter side down) carefully placing it over the bottom pan and making sure the poka-yoke pin is aligned correctly.



IMPORTANT

Make sure you do not pinch the wires or the gasket between the top cover and bottom pan contact surface.

6. Attach the top cover to the bottom pan:
 - a. Torque the four new fixation screws in the star pattern shown below at 53 in-lbs (6 Nm) for 12-inch lights or 31 in-lbs (3.5 Nm) for 8-inch lights.

Figure 51: Star pattern

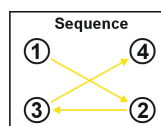

- b. Re-torque in the same pattern and at the same torque value.
7. [Test the Light Fixture for Leaks \(Water-Tightness\)](#)

7.11 Test the Light Fixture for Leaks (Water-Tightness)



Note

A compressor, or a manual car tire pump, equipped with a manometer is required to check the light fixture for watertightness.

Tools to be used:

- Flat head screwdriver
- Pressure test fitting tool to be used (pt no.44A6104/A) for watertight testing

Figure 52: Pressure test fitting tool



Procedure:

1. Remove the pressure release screw and discard.

Figure 53: Pressure release screw

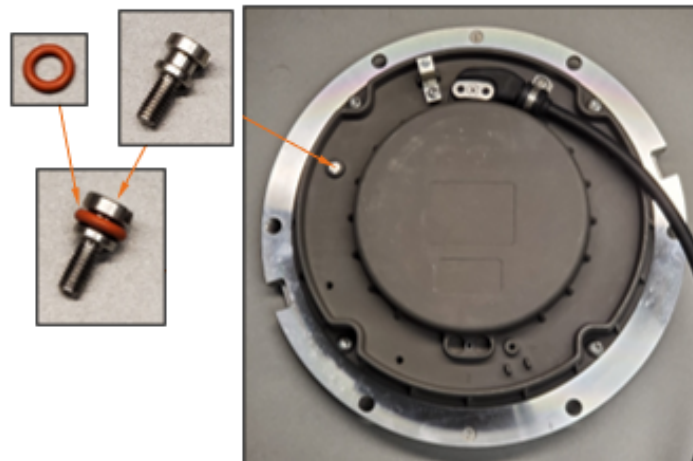

- Hand-tighten the pressure test fitting tool into the pressure-relief port. (The pressure-relief port is the opening where you removed the pressure release screw.)

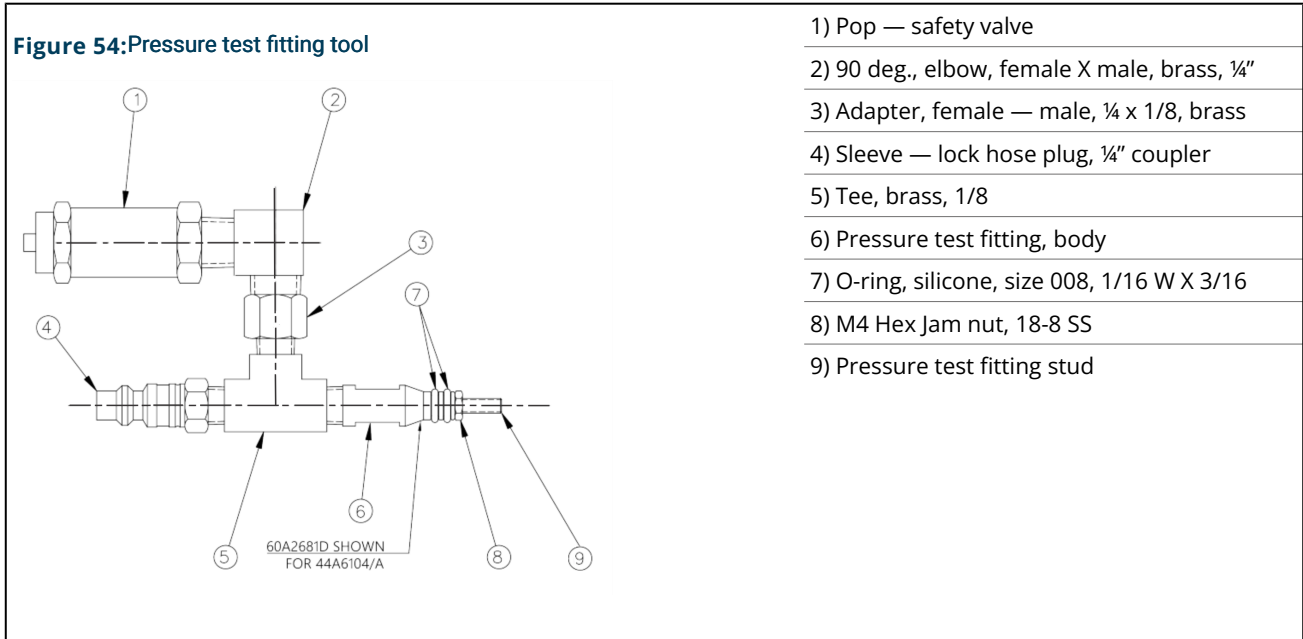

- Attach the shop airline (4) to the lock hose plug sleeve.
- Using a compressor or a manual car tire pump equipped with a manometer, pressurize to 20 psi (130 kPa). **Never exceed a pressure of 22 psi (150 kPa)** inside the light fixture. A higher pressure may cause injuries and damage the light.
- Submerge the pressure test fitting into a water tank.
- Wait 3 minutes and check if air leaks out between:
 - The bottom pan and the top cover
 - The prism and the top plate
 - The watertightness valve and top plateIf air leaks out of the light fixture, it is not watertight and must be repaired:
 - Release the air from the light
 - Disassemble the light fixture
 - Re-check the mating surfaces and gaskets
 - Re-assemble the light fixture
 - Return to step 1
- If the fixture is watertight, depressurize and install a new pressure release screw at 26 in-lbs (3 Nm).

8.0 Ordering Codes

8.1 L-850A(L) Runway Centerline and L-850B(L) Touchdown Zone

Ordering Code

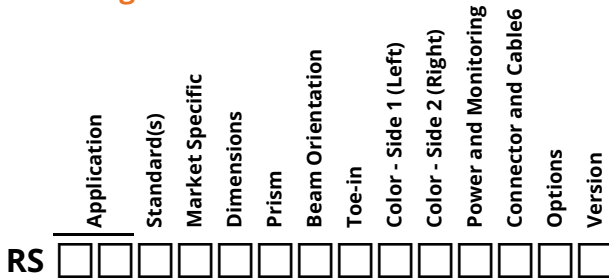

Application

RC = Runway Centerline, L-850A(L)

RZ = Touchdown Zone, L-850B(L)

Standard(s)

1 = FAA / ICAO¹

Market Specific

0 = None

1 = Buy American Preference (BAP)^{2,3}

4 = German MIL 7-step FO¹⁰

Dimensions

1 = 8 inch (203 mm) diameter, 2 bolt

2 = 12 inch (305 mm) diameter, 11.25 inch BC (285 mm)

3 = 8 inch (203 mm) diameter, 4 bolt

Prism

S = Standard prism

R = Reinforced prism¹⁰

Beam Orientation

1 = Unidirectional

2 = Bidirectional

Toe-in

L = Left Side Toe-in (Unidirectional - for RZ only)⁴

R = Right Side Toe-in (Unidirectional - for RZ only)⁴

N = None⁴

Color - Side 1 (Left)

W = White

R = Red

Color - Side 2 (Right)

W = White

R = Red

N = None (Unidirectional only)

Power and Monitoring

S = 2.8 - 6.6 A, Non-Monitored — Power Only

M = 2.8 - 6.6 A, Fail-Open Monitoring¹⁰

R = 2.8 - 6.6 A, EQ Integrated LINC 360⁵

Connector and Cable⁶

1 = 1 x Style 6 2-Pole Plug, 2 Individual Wires¹⁰

2 = 1 x Style 1 2-Pole Plug, Jacketed SO 2 Core Cable⁹

3 = 2 x Style 6 2-Pole Plug, 2 Individual Wires^{7,10}

4 = 2 x Style 1 2-Pole Plug, Jacketed SO 2 Core Cable^{7,9}

5 = 1 x Flat 3-Pole Plug, 3 Individual Wires¹⁰

6 = 2 x Flat 3-Pole Plug, 3 Individual Wires¹⁰

Options

0 = None⁸

1 = Arctic Kit⁸

Version

1 = Version 1

Ordering Code Notes

- Includes standards NATO, EASA, STAC, CAP 168, TP 312 and MOS 139.
- Required for FAA when funded by AIP.
- If a 2-cord set fixture is required meeting BAP, Digit 13, "power and monitoring", must be M.
- L and R designations are always in relationship to side 1 only.
- EQ light fixtures are only available as a one connector option.
- All Style 1 corded fixtures will include a ground lug. All Style 6 or 3-pole corded fixtures will be provided with grounding screw(s).
- Only available in digit 13 options S and M and bi-directional configuration.
- RC white/white application meets the heat rise requirements in engineering brief 67D, section 2.13.1, "arctic kit requirements" WITHOUT an arctic kit. We do not offer an arctic kit with this configuration as the additional heat would be detrimental to the life of the LEDs.
- SO cord set option is not compatible with shallow bases. If required please contact ADB Safegate.
- Not ETL submitted or not applicable to FAA market.

8.2 L-850C(L) Runway Edge \leq 45 m Width Runway

Ordering Code

Application	Standard(s)	Market Specific	Dimensions	Prism	Beam Orientation	Toe-in	Color - Side 1 (Left)	Color - Side 2 (Right)	Power and Monitoring	Connector and Cable ⁵	Options	Version
RS												

Application

RE = L-850C(L) Runway Edge \leq 45 m width

Standard(s)

1 = FAA / ICAO¹

Market Specific

0 = None

1 = Buy American Preference (BAP)^{1,2}

4 = German MIL 7-step FO⁹

Dimensions

2 = 12 inch (305 mm) diameter, 11.25 inch BC (285 mm)

Prism

S = Standard prism

R = Reinforced prism⁹

Beam Orientation

1 = Unidirectional

2 = Bidirectional

Toe-in

L = Left Side Toe-in (Unidirectional)

R = Right Side Toe-in (Unidirectional)

C = Both Sides Toe-in (Bidirectional)

Color - Side 1 (Left)

W = White

Y = Yellow

R = Red

F = F-Green (ICAO, default green)

Color - Side 2 (Right)

W = White

Y = Yellow

R = Red

F = F-Green (ICAO, default green)

Power and Monitoring

S = 2.8 - 6.6 A, Non-Monitored — Power Only

M = 2.8 - 6.6 A, Fail-Open Monitoring⁹

R = 2.8 - 6.6 A, EQ Integrated LINC 360⁴

Connector and Cable⁵

1 = 1 x Style 6 2-Pole Plug, 2 Individual Wires⁹

2 = 1 x Style 1 2-Pole Plug, Jacketed SO 2 Core Cable⁸

3 = 2 x Style 6 2-Pole Plug, 2 Individual Wires^{6,9}

4 = 2 x Style 1 2-Pole Plug, Jacketed SO 2 Core Cable^{6,8,9}

5 = 1 x Flat 3-Pole Plug, 3 Individual Wires⁹

6 = 2 x Flat 3-Pole Plug, 3 Individual Wires⁹

Options

0 = None⁷

Version

1 = Version 1

Ordering Code Notes

- Includes standards NATO, EASA, STAC, CAP 168, TP 312 and MOS 139.
- Required for FAA when funded by AIP.
- If a 2-cord set fixture is required meeting BAP, digit 13, "Power and Monitoring", must be M.
- EQ light fixtures are only available as a one connector option.
- All Style 1 corded fixtures will include a ground lug. All Style 6 or 3-pole corded fixtures will be provided with grounding screw(s).
- Only available in power and monitoring options S and M.
- RE white/white and white/yellow applications meet the heat rise requirements in engineering brief 67D, section 2.13.1, "arctic kit requirements" WITHOUT an arctic kit. We do not offer an arctic kit with this configuration as the additional heat would be detrimental to the life of the LEDs.
- SO cord set option is not compatible with shallow bases. If required please contact ADB Safegate.
- Not ETL submitted or not applicable to FAA market.

8.3 ICAO Runway Edge \leq 60 m Width Runway

Ordering Code

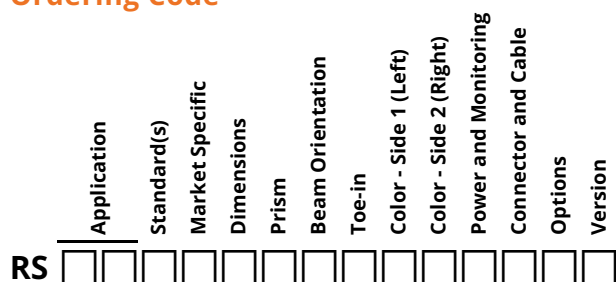

Application

R6 = Runway Edge \leq 60m

Standard(s)

3 = ICAO¹

Market Specific

0 = None

4 = German MIL 7-step FO

Dimensions

2 = 12 inch (305 mm) diameter, 11.25 inch BC (285 mm)

Prism

S = Standard prism

R = Reinforced prism

Beam Orientation

1 = Unidirectional

2 = Bidirectional

Toe-in

L = Left Side Toe-in (Unidirectional)²

R = Right Side Toe-in (Unidirectional)²

C = Both Sides Toe-in (Bidirectional)

Color - Side 1 (Left)

W = White³

Y = Yellow³

R = Red

Color - Side 2 (Right)

W = White³

Y = Yellow³

R = Red

N = None

Power and Monitoring

S = 2.8 - 6.6 A, Non-Monitored — Power Only

M = 2.8 - 6.6 A, Fail-Open Monitoring

R = 2.8 - 6.6 A, EQ Integrated LINC 360

Connector and Cable

1 = 1 x Style 6 2-Pole Plug, 2 Individual Wires²

2 = 1 x Style 1 2-Pole Plug, Jacketed SO 2 Core Cable²

3 = 2 x Style 6 2-Pole Plug, 2 Individual Wires²

4 = 2 x Style 1 2-Pole Plug, Jacketed SO 2 Core Cable²

5 = 1 x Flat 3-Pole Plug, 3 Individual Wires²

6 = 2 x Flat 3-Pole Plug, 3 Individual Wires²

Options

0 = None

1 = Arctic Kit

Version

1 = Version 1

Ordering Code Notes

1. Includes standards NATO, EASA, STAC, CAP 168, TP 312 and MOS 139.
2. All Style 1 corded fixtures will include a ground lug. All Style 6 or 3-pole corded fixtures will be provided with grounding screw(s).
3. RE white/white and white/yellow applications meet the heat rise requirements in engineering brief 67D, section 2.13.1, "arctic kit requirements" WITHOUT an arctic kit. We do not offer an arctic kit with this configuration as the additional heat would be detrimental to the life of the LEDs.

8.4 L- 852(L) Runway Guard Light

Ordering Code

	Application	Standard(s)	Market Specific	Dimensions	Prism	Beam Orientation	Toe-in	Color - Side 1 (Left)	Programming – Side 2 (Right) ³	Power and Monitoring	Connector and Cable	Options	Version
RS	<input type="checkbox"/>	<input type="checkbox"/>	<input type="checkbox"/>	<input type="checkbox"/>	<input type="checkbox"/>	<input type="checkbox"/>	<input type="checkbox"/>	<input type="checkbox"/>	<input type="checkbox"/>	<input type="checkbox"/>	<input type="checkbox"/>	<input type="checkbox"/>	<input type="checkbox"/>

Application

RG = L-852(L) Runway Guard Light

Standard(s)

2 = FAA

3 = ICAO⁶

Market Specific

0 = None

1 = Buy American Preference (BAP)¹

Dimensions

1 = 8 inch (203 mm) diameter, 2 bolt

2 = 12 inch (305 mm) diameter, 11.25 inch BC (285 mm)

3 = 8 inch (203 mm) diameter, 4 bolt

Prism

S = Standard prism

R = Reinforced prism

Beam Orientation

1 = Unidirectional

Toe-in

N = None

Color - Side 1 (Left)

Y = Yellow

Programming – Side 2 (Right)³

0 = Flash-Off

1 = Flash-On

Power and Monitoring

S = 2.8 - 6.6 A, Non-Monitored — Autonomous

R = 2.8 - 6.6 A, EQ Integrated LINC 360⁴

Connector and Cable

1 = 1 x Style 6 2-Pole Plug, 2 Individual Wires⁴

2 = 1 x Style 1 2-Pole Plug, Jacketed SO 2 Core Cable^{4,5}

5 = 1 x Flat 3-Pole Plug, 3 Individual Wires⁴

Options

0 = None

1 = Arctic Kit

Version

1 = Version 1

Ordering Code Notes

1. Required for USA FAA market.
2. 8"- 4 bolt top cover fixtures are not compatible with 8" shallow bases.
3. Side 2 will include a non-light producing window on the autonomous version which provides access to the internal optical sensor, allowing the local programming device to change flash programming. All fixtures must be ordered as either flash-on or flash-off. Typically, it is a 50/50 split between the two options.
4. All Style 1 corded fixtures will include a ground lug. All Style 6 or 3-pole corded fixtures will be provided with grounding screw(s).
5. Style 1 SO cord-set not compatible with 8" shallow bases using side entry.
6. Includes standards NATO, EASA, STAC, CAP 168, TP 312 and MOS 139.

8.5 FAA L-850D(L) Runway Threshold and Threshold/End; ICAO and FAA Runway End

Ordering Code

	Application	Standard(s)	Market Specific	Dimensions	Prism	Beam Orientation	Toe-in	Color - Side 1 (Left)	Color - Side 2 (Right)	Power and Monitoring	Connector and Cable	Options	Version
RS	<input type="checkbox"/>	<input type="checkbox"/>	<input type="checkbox"/>	<input type="checkbox"/>	<input type="checkbox"/>	<input type="checkbox"/>	<input type="checkbox"/>	<input type="checkbox"/>	<input type="checkbox"/>	<input type="checkbox"/>	<input type="checkbox"/>	<input type="checkbox"/>	<input type="checkbox"/>

Application

RN = L-850D(L) Runway End

RT = L-850D(L) Runway Threshold, Threshold End

Standard(s)

2 = FAA

3 = ICAO¹⁰

Market Specific

0 = None

1 = Buy American Preference (BAP)^{1,2}

Dimensions

2 = 12 inch (305 mm) diameter, 11.25 inch BC (285 mm)

Prism

S = Standard prism

R = Reinforced prism

Beam Orientation

1 = Unidirectional

2 = Bidirectional

Toe-in

L = Left Side Toe-in (Unidirectional)³

R = Right Side Toe-in (Unidirectional)³

N = None (RN must be N)³

Color - Side 1 (Left)

F = F-Green (ICAO, default green)

R = Red⁷

Color - Side 2 (Right)

R = Red

N = None

Power and Monitoring

S = 2.8 - 6.6 A, Non-Monitored — Power Only⁴

M = 2.8 - 6.6 A, Fail-Open Monitoring⁴

R = 2.8 - 6.6 A, EQ Integrated LINC 360

Connector and Cable

1 = 1 x Style 6 2-Pole Plug, 2 Individual Wires^{5,9}

2 = 1 x Style 1 2-Pole Plug, Jacketed SO 2 Core Cable⁵

3 = 2 x Style 6 2-Pole Plug, 2 Individual Wires^{4,5,6,9}

4 = 2 x Style 1 2-Pole Plug, Jacketed SO 2 Core Cable^{4,5,6}

Options

0 = None^{7,8}

1 = Arctic Kit^{7,8}

Version

1 = Version 1

Ordering Code Notes

1. Required for FAA when funded by AIP.
2. If a 2-cord set fixture is required meeting BAP, Digit 13, "power and monitoring", must be M.
3. L and R designations are always in relationship to side 1 only.
4. EQ light fixtures are only available as a one connector option.
5. All Style 1 corded fixtures will include a ground lug. All Style 6 or 3-pole corded fixtures will be provided with grounding screw(s).
6. Only available in digit 13 options S and M and bi-directional configuration.
7. RN red application meets the heat rise requirements in engineering brief 67D, section 2.13.1, "arctic kit requirements" WITHOUT an arctic kit. We do not offer an arctic kit with this configuration as the additional heat would be detrimental to the life of the LEDs.
8. RT green application does not meet the heat rise requirements in engineering brief 67D, section 2.13.1, "arctic kit requirements" WITHOUT an arctic kit.
9. Not ETL submitted or not applicable to FAA market.
10. RN application only. (RT ICAO is found in AXON high intensity approach and runway threshold manual – UM-5057)

8.6 ICAO Stopway ≤ 45 m Width Runway

Ordering Code

	Application	Standard(s)	Market Specific	Dimensions	Prism	Beam Orientation	Toe-in	Color - Side 1 (Left)	Color - Side 2 (Right)	Power and Monitoring	Connector and Cable ²	Options	Version
RS	<input type="checkbox"/>	<input type="checkbox"/>	<input type="checkbox"/>	<input type="checkbox"/>	<input type="checkbox"/>	<input type="checkbox"/>	<input type="checkbox"/>	<input type="checkbox"/>	<input type="checkbox"/>	<input type="checkbox"/>	<input type="checkbox"/>	<input type="checkbox"/>	<input type="checkbox"/>

Application

SW = Stopway 45 m Runway

Standard(s)

3 = ICAO¹

Market Specific

0 = None

Dimensions

2 = 12 inch (305 mm) diameter, 11.25 inch BC (285 mm)

Prism

S = Standard prism

R = Reinforced prism

Beam Orientation

1 = Unidirectional

Toe-in

L = Left Side Toe-in (Unidirectional)

R = Right Side Toe-in (Unidirectional)

Color - Side 1 (Left)

R = Red

Color - Side 2 (Right)

N = None

Power and Monitoring

S = 2.8 - 6.6 A, Non-Monitored — Power Only

M = 2.8 - 6.6 A, Fail-Open Monitoring

R = 2.8 - 6.6 A, EQ Integrated LINC 360

Connector and Cable²

1 = 1 x Style 6 2-Pole Plug, 2 Individual Wires

2 = 1 x Style 1 2-Pole Plug, Jacketed SO 2 Core Cable

5 = 1 x Flat 3-Pole Plug, 3 Individual Wires

Options

0 = None

1 = Arctic Kit

Version

1 = Version 1

Ordering Code Notes

- Includes standards NATO, EASA, STAC, TP 312 and MOS 139.
- All Style 1 corded fixtures will include a ground lug. All Style 6 or 3-pole corded fixtures will be provided with grounding screw(s).

8.7 RWSL: L-850T(L) Runway Takeoff/Hold and Intersection Light (THL/ RIL)

Ordering Code

	Application	Standard(s)	Market Specific	Dimensions	Prism	Beam Orientation	Toe-in	Color - Side 1 (Left)	Color - Side 2 (Right)	Power and Monitoring	Connector and Cable ¹	Options	Version
RS	<input type="checkbox"/>	<input type="checkbox"/>	<input type="checkbox"/>	<input type="checkbox"/>	<input type="checkbox"/>	<input type="checkbox"/>	<input type="checkbox"/>	<input type="checkbox"/>	<input type="checkbox"/>	<input type="checkbox"/>	<input type="checkbox"/>	<input type="checkbox"/>	<input type="checkbox"/>

Application

RS = Runway Status; Takeoff/ Hold (THL); L-850T(L) (RIL); Runway Intersection

TS = Runway Status; Runway Entry (REL)¹

Standard(s)

2 = FAA

3 = ICAO

Market Specific

0 = None

1 = Buy American Preference (BAP)

Dimensions

1 = 8 inch (203 mm) diameter, 2 bolt³

2 = 12 inch (305 mm) diameter, 11.25 inch BC (285 mm)

3 = 8 inch (203 mm) diameter, 4 bolt³

Prism

S = Standard prism

R = Reinforced prism³

Beam Orientation

1 = Unidirectional

Toe-in

N = None

Color - Side 1 (Left)

R = Red

Color - Side 2 (Right)

N = Not Applicable

Power and Monitoring

R = 2.8 - 6.6 A, EQ Integrated LINC 360

Connector and Cable¹

1 = 1 x Style 6 2-Pole Plug, 2 Individual Wires

2 = 1 x Style 1 2-Pole Plug, Jacketed SO 2 Core Cable²

Options

0 = None

1 = Arctic Kit

Version

1 = Version 1

Ordering Code Notes

1. All Style 1 corded fixtures will include a ground lug. All Style 6 or 3-pole corded fixtures will be provided with grounding screw(s).
2. SO cord set option is not compatible with shallow bases. If required please contact ADB Safegate.
3. Not ETL submitted or not applicable to FAA market.

8.8 ICAO Rapid Exit Taxiway Indicator Light (RETIL)

Ordering Code

	Application	Standard(s)	Market Specific	Dimensions	Prism	Beam Orientation	Toe-in	Color - Side 1 (Left)	Color - Side 2 (Right)	Power and Monitoring	Connector and Cable2	Options	Version
RS	<input type="checkbox"/>	<input type="checkbox"/>	<input type="checkbox"/>	<input type="checkbox"/>	<input type="checkbox"/>	<input type="checkbox"/>	<input type="checkbox"/>	<input type="checkbox"/>	<input type="checkbox"/>	<input type="checkbox"/>	<input type="checkbox"/>	<input type="checkbox"/>	<input type="checkbox"/>

Application

RY = Rapid Exit Taxiway Indicator Light (RETIL)

Standard(s)

3 = ICAO¹

Market Specific

0 = None

4 = German MIL 7-step FO

Dimensions

1 = 8 inch (203 mm) diameter, 2 bolt

2 = 12 inch (305 mm) diameter, 11.25 inch BC (285 mm)

Prism

S = Standard prism

R = Reinforced prism

Beam Orientation

1 = Unidirectional

Toe-in

N = None

Color - Side 1 (Left)

Y = Yellow

Color - Side 2 (Right)

N = Not Applicable

Power and Monitoring

M = 2.8 - 6.6 A, Fail-Open Monitoring²

R = 2.8 - 6.6 A, EQ Integrated LINC 360

Connector and Cable²

1 = 1 x Style 6 2-Pole Plug, 2 Individual Wires³

2 = 1 x Style 1 2-Pole Plug, Jacketed SO 2 Core Cable³

5 = 1 x Flat 3-Pole Plug, 3 Individual Wires

Options

0 = None

1 = Arctic Kit

Version

1 = Version 1

Ordering Code Notes

1. Includes standards NATO, EASA, STAC, TP 312 and MOS 139.
2. EQ light fixtures are only available as a one connector option.
3. All Style 1 corded fixtures will include a ground lug. All Style 6 or 3-pole corded fixtures will be provided with grounding screw(s).

8.9 ICAO Stopway ≤ 60 m Width Runway

Ordering Code

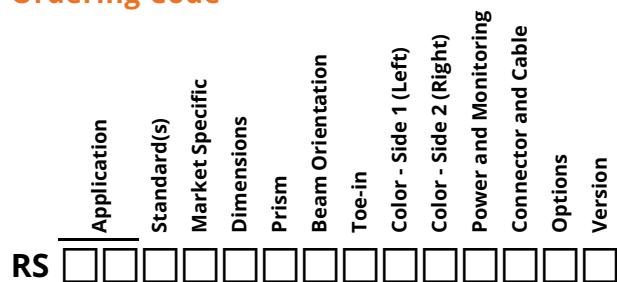

Application

S6 = Stopway 60 m Runway

Standard(s)

3 = ICAO¹

Market Specific

0 = None

Dimensions

2 = 12 inch (305 mm) diameter, 11.25 inch BC (285 mm)

Prism

S = Standard prism

R = Reinforced prism

Beam Orientation

1 = Unidirectional

Toe-in

L = Left Side Toe-in (Unidirectional)

R = Right Side Toe-in (Unidirectional)

Color - Side 1 (Left)

R = Red

Color - Side 2 (Right)

N = None

Power and Monitoring

S = 2.8 - 6.6 A, Non-Monitored — Power Only

M = 2.8 - 6.6 A, Fail-Open Monitoring

R = 2.8 - 6.6 A, EQ Integrated LINC 360¹⁰

Connector and Cable

1 = 1 x Style 6 2-Pole Plug, 2 Individual Wires²

2 = 1 x Style 1 2-Pole Plug, Jacketed SO 2 Core Cable²

5 = 1 x Flat 3-Pole Plug, 3 Individual Wires²

Options

0 = None

1 = Arctic Kit

Version

1 = Version 1

Ordering Code Notes

- Includes standards NATO, EASA, STAC, TP 312 and MOS 139.
- All Style 1 corded fixtures will include a ground lug. All Style 6 or 3-pole corded fixtures will be provided with grounding screw(s).

9.0 Spare Parts

Spare parts are available for inset light fixtures with and without the control and monitoring functionality. For more information, see the spare parts at www.adbsafegate.com or contact ADB SAFEGATE for assistance.

9.1 Versions and Exploded View

Partial Exploded View — Spare Part Assemblies

Figure 55: 8-inch fixtures (left) and 12-inch fixtures (right)

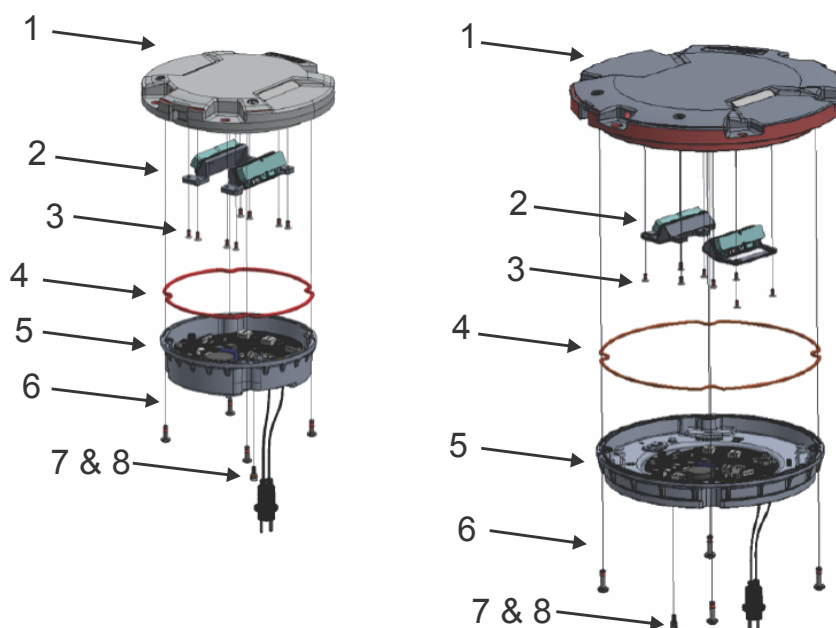

Call-out	Description	Assembly number prefix
1	Top cover assembly, 8-inch	SP.AS00019-XXX
1	Top Cover Assembly, 12-inch	SP.AS00018-XXX
2	Light Engine Assembly, 8-inch	SP.AS00020-XXX
2	Light Engine Assembly, 12-inch	SP.AS00023-XXX
3	Mounting Screws, Light Engine	SP.MFPM4PT-708-01
4	Gasket, 8" Bottom Pan	SP.MS00005-000-01
4	Gasket, 12" Bottom Pan	SP.MS00006-000-01
5	Bottom Pan Assembly, 8-inch	SP.AS00021-XXX
5	Bottom Pan Assembly, 12-inch	SP.AS00024-XXX
6	Mounting Screws, 8" Bottom Pan	SP.MFPM5PT-714-01
6	Mounting Screws, 12" Bottom Pan	SP.MFPM6PT-720-01
7 and 8	Pressure Relief Screw with O-ring	SP.MF00090-000-01

9.2 Illustration

Figure 56: 12-inch and 8-inch Runway Insets



Figure 57: Top Cover Assembly

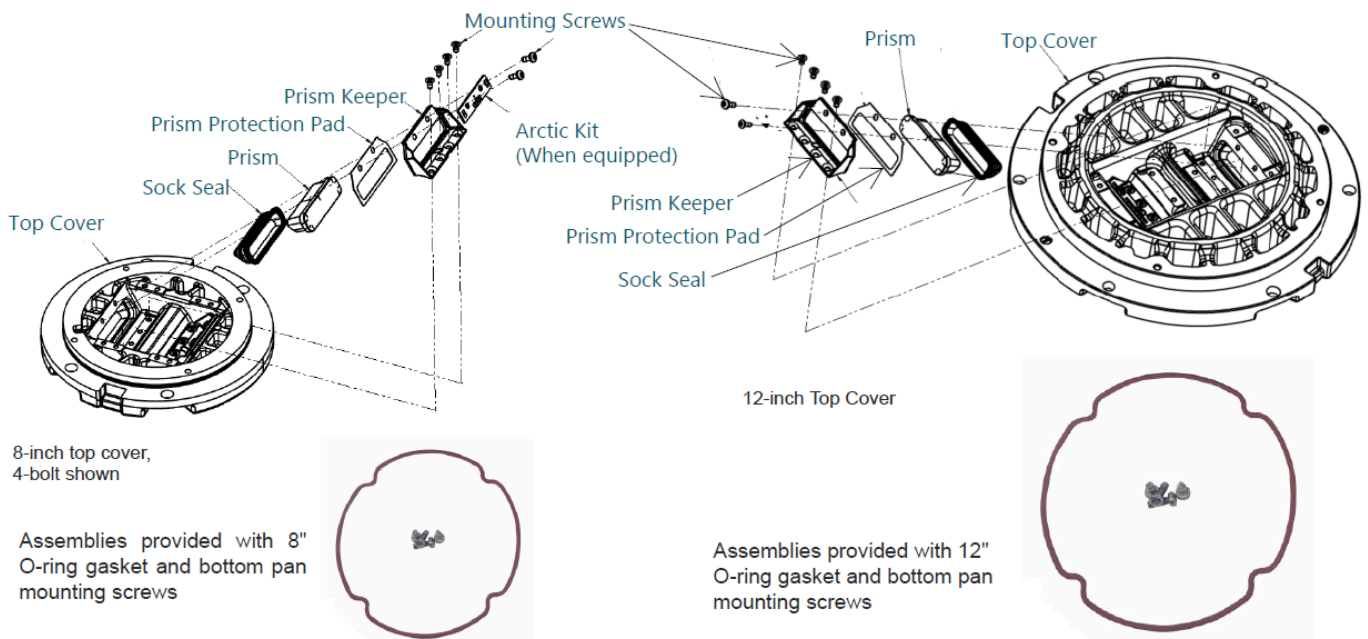

Figure 58: Bottom Pan Assembly, 8-inch

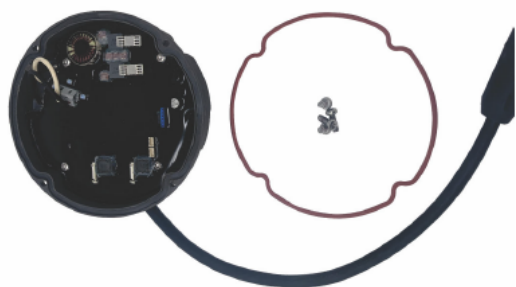

Figure 59: Bottom Pan Assembly, 12-inch



Shown with Gasket Installed

All bottom pan assemblies include a power supply, cord set, ground lug or ground screw, an O-ring gasket, and four bottom pan mounting screws.

Figure 60: Bottom Pan Gasket, 8-inch, Package of 10



Figure 61: Bottom Pan Gasket, 12-inch Package of 10

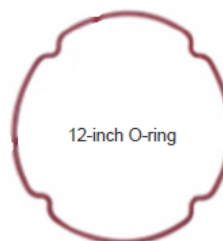
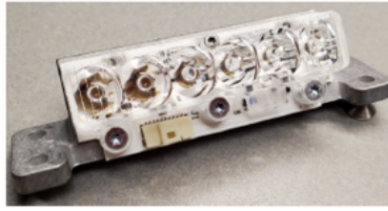

Figure 62: LED Light Engines Wire Harness, Package of 10



Sized for 8" and 12" Fixtures

Figure 63: Light Engine Assembly, Package of 2



8" Fixture Light Engines



12" Fixture Light Engines

Figure 64: Prism Kit, Package of 2



- Available in standard or protected (sapphire) prism.
- Kit includes the Prism, Sock Seal (both shown), Prism Protection Pad, Prism Keeper and all mounting screws.

Figure 65: Ground Lugs, Package of 5



Figure 66: Style-1 Cord Set Cable Clamp, Package of 5 Figure 67: Mounting Screws, Package of 100



Figure 68: Pressure Release Screws, Package of 5 Figure 69: Arctic Kit, Package of 2

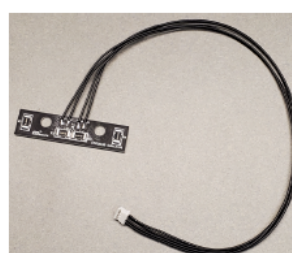

Note

Pressure release screw O-ring is to be replaced with new O-ring prior to re-installation of the pressure release screw.

9.3 L-850A(L) Runway Centerline



Note

- Each top cover and bottom pan assembly includes a gasket and screws for the bottom pan.
- Each light engine and heater kit assembly includes mounting screws.
- Each prism kit includes prism, gasket, protection plate (if applicable) and mounting screws.
- BAP stands for "buy American preference".

Top cover assemblies, 12-inch, <u>without</u> heater	Quantity per		Spare part code
	Fitting	Spare part	
Unidirectional, standard prism	1	1	SP.AS00018-UNG
Unidirectional, reinforced prism	1	1	SP.AS00018-UNS
Bidirectional, standard prism	1	1	SP.AS00018-BNG
Bidirectional, reinforced prism	1	1	SP.AS00018-BNS

Top Cover assemblies, 12-inch, <u>with</u> heater	Quantity per		Spare part code
	Fitting	Spare part	
Unidirectional, standard prism, non-monitored (S-BAP) & EQ (R)	1	1	SP.AS00018-UAG
Unidirectional, reinforced prism, non-monitored (S-BAP) & EQ (R)	1	1	SP.AS00018-UAS
Unidirectional, standard prism, non-monitored (S-non-BAP) & monitored (M)	1	1	SP.AS00018-UBG
Unidirectional, reinforced prism, non-monitored (S-non-BAP) & monitored (M)	1	1	SP.AS00018-UBS
Bidirectional, standard prism, non-monitored (S-BAP) & EQ (R)	1	1	SP.AS00018-BAG
Bidirectional, reinforced prism, non-monitored (S-BAP) & EQ (R)	1	1	SP.AS00018-BAS
Bidirectional, standard prism, non-monitored (S-non-BAP) & monitored (M)	1	1	SP.AS00018-BBG
Bidirectional, reinforced prism, non-monitored (S-non-BAP) & monitored (M)	1	1	SP.AS00018-BBS

Top cover assemblies, 8-inch (2-bolt), <u>without</u> heater	Quantity per		Spare part code
	Fitting	Spare part	
Unidirectional, standard prism	1	1	SP.AS00019-3NG
Unidirectional, reinforced prism	1	1	SP.AS00019-3NS
Bidirectional, standard prism	1	1	SP.AS00019-4NG
Bidirectional, reinforced prism	1	1	SP.AS00019-4NS

Top cover assemblies, 8-inch (2-bolt), <u>with</u> heater	Quantity per		Spare part code
	Fitting	Spare part	
Unidirectional, standard prism, non-monitored (S-BAP) & EQ (R)	1	1	SP.AS00019-3AG
Unidirectional, reinforced prism, non-monitored (S-BAP) & EQ (R)	1	1	SP.AS00019-3AS
Unidirectional, standard prism, non-monitored (S-non-BAP) & monitored (M)	1	1	SP.AS00019-3BG
Unidirectional, reinforced prism, non-monitored (S-non-BAP) & monitored (M)	1	1	SP.AS00019-3BS
Bidirectional, standard prism, non-monitored (S-BAP) & EQ (R)	1	1	SP.AS00019-4AG
Bidirectional, reinforced prism, non-monitored (S-BAP) & EQ (R)	1	1	SP.AS00019-4AS
Bidirectional, standard prism, non-monitored (S-non-BAP) & monitored (M)	1	1	SP.AS00019-4BG
Bidirectional, reinforced prism, non-monitored (S-non-BAP) & monitored (M)	1	1	SP.AS00019-4BS

Top cover assemblies, 8-inch (4-bolt), <u>without</u> heater	Quantity per		Spare part code
	Fitting	Spare part	
Unidirectional, standard prism	1	1	SP.AS00019-5NG
Unidirectional, reinforced prism	1	1	SP.AS00019-5NS
Bidirectional, standard prism	1	1	SP.AS00019-6NG
Bidirectional, reinforced prism	1	1	SP.AS00019-6NS

Top cover assemblies, 8-inch (4-bolt), <u>with</u> heater	Quantity per		Spare part code
	Fitting	Spare part	
Unidirectional, standard prism, non-monitored (S-BAP) & EQ (R)	1	1	SP.AS00019-5AG
Unidirectional, reinforced prism, non-monitored (S-BAP) & EQ (R)	1	1	SP.AS00019-5AS
Unidirectional, standard prism, non-monitored (S-non-BAP) & monitored (M)	1	1	SP.AS00019-5BG
Unidirectional, reinforced prism, non-monitored (S-non-BAP) & monitored (M)	1	1	SP.AS00019-5BS
Bidirectional, standard prism, non-monitored (S-BAP) & EQ (R)	1	1	SP.AS00019-6AG
Bidirectional, reinforced prism, non-monitored (S-BAP) & EQ (R)	1	1	SP.AS00019-6AS
Bidirectional, standard prism, non-monitored (S-non-BAP) & monitored (M)	1	1	SP.AS00019-6BG
Bidirectional, reinforced prism, non-monitored (S-non-BAP) & monitored (M)	1	1	SP.AS00019-6BS

Light engine assemblies, 12-inch	Quantity per		Spare part code
	Fitting	Spare part	
ICAO & FAA L-850A(L), red, straight	1 or 2	1	SP.AS00023-SR1
ICAO & FAA L-850A(L), white, straight	1 or 2	1	SP.AS00023-SW2

Light engine assemblies, 8-inch	Quantity per		Spare part code
	Fitting	Spare part	
ICAO & FAA L-850A(L), red, straight	1 or 2	1	SP.AS00020-SR1
ICAO & FAA L-850A(L)/L-850B(L), white, straight	1 or 2	1	SP.AS00020-SW2

Bottom pan assemblies, 12-inch	Quantity per		Spare part code
	Fitting	Spare part	
Non-monitored converter, style 6 cord set	1	1	SP.AS00024-L13
Non-monitored converter, 3-pole cord set	1	1	SP.AS00024-L1F
Non-monitored converter, style 1 SJO jacketed cord set	1	1	SP.AS00024-L1J
Non-monitored converter, 2-con style 6 cord set	1	1	SP.AS00024-L23
Non-monitored converter, 2-con 3-pole cord set	1	1	SP.AS00024-L2F
Non-monitored converter, 2-con style 1 SJO jacketed cord set	1	1	SP.AS00024-L2J
Monitored converter, style 6 cord set	1	1	SP.AS00024-M13
Monitored converter, 3-pole cord set	1	1	SP.AS00024-M1F
Monitored converter, style 1 SJO jacketed cord set	1	1	SP.AS00024-M1J
Monitored converter, 2-con style 6 cord sets	1	1	SP.AS00024-M23
Monitored converter, 2-con 3-pole cord sets	1	1	SP.AS00024-M2F
Monitored converter, 2-con style 1 SJO jacketed cord sets	1	1	SP.AS00024-M2J
EQ converter, style 6 cord set	1	1	SP.AS00024-R13
EQ converter, 3-pole cord set	1	1	SP.AS00024-R1F
EQ converter, style 1 SJO jacketed cord set	1	1	SP.AS00024-R1J
BAP, non-monitored converter, style 6 cord set	1	1	SP.AS00024-S13
BAP, non-monitored converter, style 1 SJO jacketed cord set	1	1	SP.AS00024-S1J

Bottom pan assemblies, 8-inch	Quantity per		Spare part code
	Fitting	Spare part	
Non-monitored converter, style 6 cord set	1	1	SP.AS00021-L13
Non-monitored converter, 3-pole cord set	1	1	SP.AS00021-L1F
Non-monitored converter, style 1 SJO jacketed cord set	1	1	SP.AS00021-L1J
Non-monitored converter, 2-con style 6 cord sets	1	1	SP.AS00021-L23
Non-monitored converter, 2-con 3-pole cord sets	1	1	SP.AS00021-L2F
Non-monitored converter, 2-con style 1 SJO jacketed cord sets	1	1	SP.AS00021-L2J
Monitored converter, style 6 cord set	1	1	SP.AS00021-M13
Monitored converter, 3-pole cord set	1	1	SP.AS00021-M1F
Monitored converter, style 1 SJO jacketed cord set	1	1	SP.AS00021-M1J
Monitored converter, 2-con style 6 cord sets	1	1	SP.AS00021-M23
Monitored converter, 2-con 3-pole cord sets	1	1	SP.AS00021-M2F
Monitored converter, 2-con style 1 SJO jacketed cord sets	1	1	SP.AS00021-M2J
EQ converter, style 6 cord set	1	1	SP.AS00021-R13
EQ converter, 3-pole cord set	1	1	SP.AS00021-R1F
EQ converter, style 1 SJO jacketed cord set	1	1	SP.AS00021-R1J
BAP non-monitored converter, style 6 cord set	1	1	SP.AS00021-S13
BAP non-monitored converter, style 1 SJO jacketed cord set	1	1	SP.AS00021-S1J

Cord sets	Quantity per		Spare part code
	Fitting	Spare part	
L-823 style 1, 8-inch bottom pan	1 or 2	5	SP.73A0193/1
L-823 style 1, 12-inch bottom pan	1 or 2	5	SP.73A0194/1
L-823 style 6, bottom pan	1 or 2	5	SP.73A0136/18
3-pole, bottom pan	1 or 2	5	SP.SGEFR500160
Cable retaining clamp, for style 1 cord set	1 or 2	5	SP.MB00003-013-01
Ground lug kit	1	5	SP.72A0401
Grounding kit style 6 (bolt & washer)	1 or 2	100	SP00102-100-01

Prism kits	Quantity per		Spare part code
	Fitting	Spare part	
Prism kit, runway standard, package of 2	1 or 2	2	SP.MG00001-G00-03
Prism kit, runway reinforced, package of 2	1 or 2	2	SP.MG00001-S00-03
Prism gaskets, runway, package of 10	1 or 2	10	SP.MS00004-000-02

Screws & gaskets	Quantity per		Spare part code
	Fitting	Spare part	
Screws, pressure release with o-ring, package of 5	1	5	SP.MF00090-000-01
Gaskets, 8-inch bottom pan, package of 10	1	10	SP.MS00005-000-01
Gaskets, 12-inch bottom pan, package of 10	1	10	SP.MS00006-000-01
Screws, bottom pan, package of 100	-	100	SP.MFPM5PT-714-01
Screws, 12-inch bottom pan, package of 100	-	100	SP.MFPM6PT-720-01
Screws, mounting light engine assemblies, package of 100	-	100	SP.MFPM4PT-710-01

Heater kits	Quantity per		Spare part code
	Fitting	Spare part	
Non-monitored (S-BAP) & EQ, with harness	1 or 2	2	SP.EP00038-R00-01
Non-monitored (S-non-BAP) & monitored, with harness	1 or 2	2	SP.EP00038-R01-01

Wire harnesses	Quantity per		Spare part code
	Fitting	Spare part	
Power supply to 8-inch light engine, package of 10	1 or 2	10	SP.EW00079-150-01
Power supply to 12-inch light engine, package of 10	1 or 2	10	SP.EW00079-300-01

Fuse resistors - only for fixtures with monitoring (M)	Quantity per		Spare part code
	Fitting	Spare part	
For use with legacy converters	1 or 2	20	SP.6132.00.250
For use with new style mon converters	1 or 2	20	SP.EZ00015-000-01



Note

Component availability or design may be subject to change due to unforeseen circumstances. This document is subject to change or new information from ADB SAFEGATE, as and when available or if required, with reservation for error or price changes.

For more information or assistance with ordering spare parts, contact ADB SAFEGATE, see www.adbsafegate.com.

9.4 ICAO and FAA L-850B(L) Touchdown Zone



Note

- Each top cover and bottom pan assembly includes a gasket and screws for the bottom pan.
- Each light engine and heater kit assembly includes mounting screws.
- Each prism kit includes prism, gasket, protection plate (if applicable) and mounting screws.
- BAP stands for "buy American preference".

Top cover assemblies, 12-inch, <u>without</u> heater	Quantity per		Spare part code
	Fitting	Spare part	
Unidirectional, standard prism	1	1	SP.AS00018-UNG
Unidirectional, reinforced prism	1	1	SP.AS00018-UNS

Top Cover assemblies, 12-inch, <u>with</u> heater	Quantity per		Spare part code
	Fitting	Spare part	
Unidirectional, standard prism, non-monitored (S-BAP) & EQ (R)	1	1	SP.AS00018-UAG
Unidirectional, reinforced prism, non-monitored (S-BAP) & EQ (R)	1	1	SP.AS00018-UAS
Unidirectional, standard prism, non-monitored (S-non-BAP) & monitored (M)	1	1	SP.AS00018-UBG
Unidirectional, reinforced prism, non-monitored (S-non-BAP) & monitored (M)	1	1	SP.AS00018-UBS

Top cover assemblies, 8-inch (2-bolt), <u>without</u> heater	Quantity per		Spare part code
	Fitting	Spare part	
Unidirectional, standard prism	1	1	SP.AS00019-3NG
Unidirectional, reinforced prism	1	1	SP.AS00019-3NS

Top cover assemblies, 8-inch (2-bolt), <u>with</u> heater	Quantity per		Spare part code
	Fitting	Spare part	
Unidirectional, standard prism, non-monitored (S-BAP) & EQ (R)	1	1	SP.AS00019-3AG
Unidirectional, reinforced prism, non-monitored (S-BAP) & EQ (R)	1	1	SP.AS00019-3AS
Unidirectional, standard prism, non-monitored (S-non-BAP) & monitored (M)	1	1	SP.AS00019-3BG
Unidirectional, reinforced prism, non-monitored (S-non-BAP) & monitored (M)	1	1	SP.AS00019-3BS

Top cover assemblies, 8-inch (4-bolt), <u>without</u> heater	Quantity per		Spare part code
	Fitting	Spare part	
Unidirectional, standard prism	1	1	SP.AS00019-5NG
Unidirectional, reinforced prism	1	1	SP.AS00019-5NS

Top cover assemblies, 8-inch (4-bolt), <u>with</u> heater	Quantity per		Spare part code
	Fitting	Spare part	
Unidirectional, standard prism, non-monitored (S-BAP) & EQ (R)	1	1	SP.AS00019-5AG
Unidirectional, reinforced prism, non-monitored (S-BAP) & EQ (R)	1	1	SP.AS00019-5AS
Unidirectional, standard prism, non-monitored (S-non-BAP) & monitored (M)	1	1	SP.AS00019-5BG
Unidirectional, reinforced prism, non-monitored (S-non-BAP) & monitored (M)	1	1	SP.AS00019-5BS

Light engine assemblies, 12-inch	Quantity per		Spare part code
	Fitting	Spare part	
ICAO & FAA L-850B(L), white, left toe	1	1	SP.AS00023-LW2
ICAO & FAA L-850B(L), white, straight	1	1	SP.AS00023-SW2
ICAO & FAA L-850B(L), white, right toe	1	1	SP.AS00023-RW2

Light engine assemblies, 8-inch	Quantity per		Spare part code
	Fitting	Spare part	
ICAO & FAA L-850B(L), white, left toe	1	1	SP.AS00020-LW2
ICAO & FAA L-850B(L), white, straight	1	1	SP.AS00020-SW2
ICAO & FAA L-850B(L), white, right toe	1	1	SP.AS00020-RW2

Bottom pan assemblies, 12-inch	Quantity per		Spare part code
	Fitting	Spare part	
Non-monitored converter, style 6 cord set	1	1	SP.AS00024-L13
Non-monitored converter, 3-pole cord set	1	1	SP.AS00024-L1F
Non-monitored converter, style 1 SJO jacketed cord set	1	1	SP.AS00024-L1J
Monitored converter, style 6 cord set	1	1	SP.AS00024-M13
Monitored converter, 3-pole cord set	1	1	SP.AS00024-M1F
Monitored converter, style 1 SJO jacketed cord set	1	1	SP.AS00024-M1J
EQ converter, style 6 cord set	1	1	SP.AS00024-R13
EQ converter, 3-pole cord set	1	1	SP.AS00024-R1F
EQ converter, style 1 SJO jacketed cord set	1	1	SP.AS00024-R1J

Bottom pan assemblies, 8-inch	Quantity per		Spare part code
	Fitting	Spare part	
Non-monitored converter, style 6 cord set	1	1	SP.AS00021-L13
Non-monitored converter, 3-pole cord set	1	1	SP.AS00021-L1F
Non-monitored converter, style 1 SJO jacketed cord set	1	1	SP.AS00021-L1J
Monitored converter, style 6 cord set	1	1	SP.AS00021-M13
Monitored converter, 3-pole cord set	1	1	SP.AS00021-M1F
Monitored converter, style 1 SJO jacketed cord set	1	1	SP.AS00021-M1J
EQ converter, style 6 cord set	1	1	SP.AS00021-R13
EQ converter, 3-pole cord set	1	1	SP.AS00021-R1F
EQ converter, style 1 SJO jacketed cord set	1	1	SP.AS00021-R1J

Cord sets	Quantity per		Spare part code
	Fitting	Spare part	
L-823 style 1, 8-inch bottom pan	1 or 2	5	SP.73A0193/1
L-823 style 1, 12-inch bottom pan	1 or 2	5	SP.73A0194/1
L-823 style 6, bottom pan	1 or 2	5	SP.73A0136/18
3-pole, bottom pan	1 or 2	5	SP.SGEFR500160
Cable retaining clamp, for style 1 cord set	1 or 2	5	SP.MB00003-013-01
Ground lug kit	1	5	SP.72A0401
Grounding kit style 6 (bolt & washer)	1 or 2	100	SP00102-100-01

Prism kits	Quantity per		Spare part code
	Fitting	Spare part	
Prism kit, runway standard, package of 2	1 or 2	2	SP.MG00001-G00-03
Prism kit, runway reinforced, package of 2	1 or 2	2	SP.MG00001-S00-03
Prism gaskets, runway, package of 10	1 or 2	10	SP.MS00004-000-02

Screws & gaskets	Quantity per		Spare part code
	Fitting	Spare part	
Screws, pressure release with o-ring, package of 5	1	5	SP.MF00090-000-01
Gaskets, 8-inch bottom pan, package of 10	1	10	SP.MS00005-000-01
Gaskets, 12-inch bottom pan, package of 10	1	10	SP.MS00006-000-01
Screws, bottom pan, package of 100	-	100	SP.MFPM5PT-714-01
Screws, 12-inch bottom pan, package of 100	-	100	SP.MFPM6PT-720-01
Screws, mounting light engine assemblies, package of 100	-	100	SP.MFPM4PT-710-01

Heater kits	Quantity per		Spare part code
	Fitting	Spare part	
Non-monitored (S-BAP) & EQ, with harness	1 or 2	2	SP.EP00038-R00-01
Non-monitored (S-non-BAP) & monitored, with harness	1 or 2	2	SP.EP00038-R01-01

Wire harnesses	Quantity per		Spare part code
	Fitting	Spare part	
Power supply to 8-inch light engine, package of 10	1 or 2	10	SP.EW00079-150-01
Power supply to 12-inch light engine, package of 10	1 or 2	10	SP.EW00079-300-01

Fuse resistors - only for fixtures with monitoring (M)	Quantity per		Spare part code
	Fitting	Spare part	
For use with legacy converters	1 or 2	20	SP.6132.00.250
For use with new style mon converters	1 or 2	20	SP.EZ00015-000-01



Note

Component availability or design may be subject to change due to unforeseen circumstances. This document is subject to change or new information from ADB SAFEGATE, as and when available or if required, with reservation for error or price changes.

For more information or assistance with ordering spare parts, contact ADB SAFEGATE, see www.adbsafegate.com.

9.5 L-850C(L) Runway Edge ≤ 45 m Width Runway



Note

- Each top cover and bottom pan assembly includes a gasket and screws for the bottom pan.
- Each light engine and heater kit assembly includes mounting screws.
- Each prism kit includes prism, gasket, protection plate (if applicable) and mounting screws.
- BAP stands for "buy American preference".

Top cover assemblies, 12-inch, without heater	Quantity per		Spare part code
	Fitting	Spare part	
Unidirectional, standard prism	1	1	SP.AS00018-UNG
Unidirectional, reinforced prism	1	1	SP.AS00018-UNS
Bidirectional, standard prism	1	1	SP.AS00018-BNG
Bidirectional, reinforced prism	1	1	SP.AS00018-BNS

Top Cover assemblies, 12-inch, with heater	Quantity per		Spare part code
	Fitting	Spare part	
Unidirectional, standard prism, EQ (R)	1	1	SP.AS00018-UAG
Unidirectional, reinforced prism, EQ (R)	1	1	SP.AS00018-UAS
Unidirectional, standard prism, non-monitored & monitored (M)	1	1	SP.AS00018-UBG
Unidirectional, reinforced prism, non-monitored & monitored (M)	1	1	SP.AS00018-UBS
Bidirectional, standard prism, EQ (R)	1	1	SP.AS00018-BAG
Bidirectional, reinforced prism, EQ (R)	1	1	SP.AS00018-BAS
Bidirectional, standard prism, non-monitored & monitored (M)	1	1	SP.AS00018-BBG
Bidirectional, reinforced prism, non-monitored & monitored (M)	1	1	SP.AS00018-BBS

Light engine assemblies, 12-inch	Quantity per		Spare part code
	Fitting	Spare part	
FAA L-850C(L), F-green, left toe	1	1	SP.AS00023-LF2-RE
FAA L-850C(L), F-green, right toe	1	1	SP.AS00023-RF2-RE
ICAO & FAA L-850C(L), white, left toe	1	1	SP.AS00023-LW3
ICAO & FAA L-850C(L), white, right toe	1	1	SP.AS00023-RW3
ICAO & FAA L-850C(L), yellow, left toe	1	1	SP.AS00023-LY3
ICAO & FAA L-850C(L), yellow, right toe	1	1	SP.AS00023-RY3

Bottom pan assemblies, 12-inch	Quantity per		Spare part code
	Fitting	Spare part	
Non-monitored converter, style 6 cord set	1	1	SP.AS00024-L13
Non-monitored converter, 3-pole cord set	1	1	SP.AS00024-L1F
Non-monitored converter, style 1 SJO jacketed cord set	1	1	SP.AS00024-L1J
Non-monitored converter, 2-con style 6 cord set	1	1	SP.AS00024-L23
Non-monitored converter, 2-con 3-pole cord set	1	1	SP.AS00024-L2F
Non-monitored converter, 2-con style 1 SJO jacketed cord set	1	1	SP.AS00024-L2J
Monitored converter, style 6 cord set	1	1	SP.AS00024-M13
Monitored converter, 3-pole cord set	1	1	SP.AS00024-M1F
Monitored converter, style 1 SJO jacketed cord set	1	1	SP.AS00024-M1J

Bottom pan assemblies, 12-inch	Quantity per		Spare part code
	Fitting	Spare part	
Monitored converter, 2-con style 6 cord sets	1	1	SP.AS00024-M23
Monitored converter, 2-con 3-pole cord sets	1	1	SP.AS00024-M2F
Monitored converter, 2-con style 1 SJO jacketed cord sets	1	1	SP.AS00024-M2J
EQ converter, style 6 cord set	1	1	SP.AS00024-R13
EQ converter, 3-pole cord set	1	1	SP.AS00024-R1F
EQ converter, style 1 SJO jacketed cord set	1	1	SP.AS00024-R1J

Cord sets	Quantity per		Spare part code
	Fitting	Spare part	
L-823 style 1, 12-inch bottom pan	1 or 2	5	SP.73A0194/1
L-823 style 6, bottom pan	1 or 2	5	SP.73A0136/18
3-pole, bottom pan	1 or 2	5	SP.SGEFR500160
Cable retaining clamp, for style 1 cord set	1 or 2	5	SP.MB00003-013-01
Ground lug kit	1	5	SP.72A0401
Grounding kit style 6 (bolt & washer)	1 or 2	100	SP00102-100-01

Prism kits	Quantity per		Spare part code
	Fitting	Spare part	
Prism kit, runway standard, package of 2	1 or 2	2	SP.MG00001-G00-03
Prism kit, runway reinforced, package of 2	1 or 2	2	SP.MG00001-S00-03
Prism gaskets, runway, package of 10	1 or 2	10	SP.MS00004-000-02

Screws & gaskets	Quantity per		Spare part code
	Fitting	Spare part	
Screws, pressure release with o-ring, package of 5	1	5	SP.MF00090-000-01
Gaskets, 12-inch bottom pan, package of 10	1	10	SP.MS00006-000-01
Screws, mounting light engine assemblies, package of 100	-	100	SP.MFPM4PT-710-01
Screws, 12-inch bottom pan, package of 100	-	100	SP.MFPM6PT-720-01

Heater kits	Quantity per		Spare part code
	Fitting	Spare part	
EQ, with harness	1 or 2	2	SP.EP00038-R00-01
Non-monitored & monitored with harness	1 or 2	2	SP.EP00038-R01-01

Wire harnesses	Quantity per		Spare part code
	Fitting	Spare part	
Power supply to 12-inch light engine, package of 10	1 or 2	10	SP.EW00079-300-01

Fuse resistors - only for fixtures with monitoring (M)	Quantity per		Spare part code
	Fitting	Spare part	
For use with legacy converters	1 or 2	20	SP.6132.00.250
For use with new style mon converters	1 or 2	20	SP.EZ00015-000-01



Note

Component availability or design may be subject to change due to unforeseen circumstances. This document is subject to change or new information from ADB SAFEGATE, as and when available or if required, with reservation for error or price changes.

For more information or assistance with ordering spare parts, contact ADB SAFEGATE, see www.adbsafegate.com.

9.6 ICAO Runway Edge ≤ 60 m Width Runway



Note

- Each top cover and bottom pan assembly includes a gasket and screws for the bottom pan.
- Each light engine and heater kit assembly includes mounting screws.
- Each prism kit includes prism, gasket, protection plate (if applicable) and mounting screws.
- BAP stands for "buy American preference".

Top cover assemblies, 12-inch, without heater	Quantity per		Spare part code
	Fitting	Spare part	
Unidirectional, standard prism	1	1	SP.AS00018-UNG
Unidirectional, reinforced prism	1	1	SP.AS00018-UNS
Bidirectional, standard prism	1	1	SP.AS00018-BNG
Bidirectional, reinforced prism	1	1	SP.AS00018-BNS

Top Cover assemblies, 12-inch, with heater	Quantity per		Spare part code
	Fitting	Spare part	
Unidirectional, standard prism, EQ (R)	1	1	SP.AS00018-UAG
Unidirectional, reinforced prism, EQ (R)	1	1	SP.AS00018-UAS
Unidirectional, standard prism, non-monitored & monitored (M)	1	1	SP.AS00018-UBG
Unidirectional, reinforced prism, non-monitored & monitored (M)	1	1	SP.AS00018-UBS
Bidirectional, standard prism, EQ (R)	1	1	SP.AS00018-BAG
Bidirectional, reinforced prism, EQ (R)	1	1	SP.AS00018-BAS
Bidirectional, standard prism, non-monitored & monitored (M)	1	1	SP.AS00018-BBG
Bidirectional, reinforced prism, non-monitored & monitored (M)	1	1	SP.AS00018-BBS

Light engine assemblies, 12-inch	Quantity per		Spare part code
	Fitting	Spare part	
Runway / stopway edge 60m, red, left toe	1	1	SP.AS00023-6R2
Runway edge 60m, white, left toe	1	1	SP.AS00023-6W1
Runway edge 60m, yellow, left toe	1	1	SP.AS00023-6Y3
Runway / stopway edge 60m, red, right toe	1	1	SP.AS00023-7R2
Runway edge 60m, white, right toe	1	1	SP.AS00023-7W1
Runway edge 60m, yellow, right toe	1	1	SP.AS00023-7Y3

Bottom pan assemblies, 12-inch	Quantity per		Spare part code
	Fitting	Spare part	
Non-monitored converter, style 6 cord set	1	1	SP.AS00024-L13
Non-monitored converter, 3-pole cord set	1	1	SP.AS00024-L1F
Non-monitored converter, style 1 SJO jacketed cord set	1	1	SP.AS00024-L1J
Non-monitored converter, 2-con style 6 cord set	1	1	SP.AS00024-L23
Non-monitored converter, 2-con 3-pole cord set	1	1	SP.AS00024-L2F
Non-monitored converter, 2-con style 1 SJO jacketed cord set	1	1	SP.AS00024-L2J
Monitored converter, style 6 cord set	1	1	SP.AS00024-M13
Monitored converter, 3-pole cord set	1	1	SP.AS00024-M1F
Monitored converter, style 1 SJO jacketed cord set	1	1	SP.AS00024-M1J

Bottom pan assemblies, 12-inch	Quantity per		Spare part code
	Fitting	Spare part	
Monitored converter, 2-con style 6 cord sets	1	1	SP.AS00024-M23
Monitored converter, 2-con 3-pole cord sets	1	1	SP.AS00024-M2F
Monitored converter, 2-con style 1 SJO jacketed cord sets	1	1	SP.AS00024-M2J
EQ converter, style 6 cord set	1	1	SP.AS00024-R13
EQ converter, 3-pole cord set	1	1	SP.AS00024-R1F
EQ converter, style 1 SJO jacketed cord set	1	1	SP.AS00024-R1J

Cord sets	Quantity per		Spare part code
	Fitting	Spare part	
L-823 style 1, 12-inch bottom pan	1 or 2	5	SP.73A0194/1
L-823 style 6, bottom pan	1 or 2	5	SP.73A0136/18
3-pole, bottom pan	1 or 2	5	SP.SGFEFR500160
Cable retaining clamp, for style 1 cord set	1 or 2	5	SP.MB00003-013-01
Ground lug kit	1	5	SP.72A0401
Grounding kit style 6 (bolt & washer)	1 or 2	100	SP00102-100-01

Prism kits	Quantity per		Spare part code
	Fitting	Spare part	
Prism kit, runway standard, package of 2	1 or 2	2	SP.MG00001-G00-03
Prism kit, runway reinforced, package of 2	1 or 2	2	SP.MG00001-S00-03
Prism gaskets, runway, package of 10	1 or 2	10	SP.MS00004-000-02

Screws & gaskets	Quantity per		Spare part code
	Fitting	Spare part	
Screws, pressure release with o-ring, package of 5	1	5	SP.MF00090-000-01
Gaskets, 12-inch bottom pan, package of 10	1	10	SP.MS00006-000-01
Screws, mounting light engine assemblies, package of 100	-	100	SP.MFPM4PT-710-01
Screws, 12-inch bottom pan, package of 100	-	100	SP.MFPM6PT-720-01

Heater kits	Quantity per		Spare part code
	Fitting	Spare part	
EQ, with harness	1 or 2	2	SP.EP00038-R00-01
Non-monitored & monitored with harness	1 or 2	2	SP.EP00038-R01-01

Wire harnesses	Quantity per		Spare part code
	Fitting	Spare part	
Power supply to 12-inch light engine, package of 10	1 or 2	10	SP.EW00079-300-01

Fuse resistors - only for fixtures with monitoring (M)	Quantity per		Spare part code
	Fitting	Spare part	
For use with legacy converters	1 or 2	20	SP.6132.00.250
For use with new style mon converters	1 or 2	20	SP.EZ00015-000-01



Note

Component availability or design may be subject to change due to unforeseen circumstances. This document is subject to change or new information from ADB SAFEGATE, as and when available or if required, with reservation for error or price changes.

For more information or assistance with ordering spare parts, contact ADB SAFEGATE, see www.adbsafegate.com.

9.7 FAA L - 852G(L) Runway Guard Light



Note

- Each top cover and bottom pan assembly includes a gasket and screws for the bottom pan.
- Each light engine and heater kit assembly includes mounting screws.
- Each prism kit includes prism, gasket, protection plate (if applicable) and mounting screws.
- BAP stands for "buy American preference".

Top cover assemblies, 12-inch, <u>without</u> heater	Quantity per		Spare part code
	Fitting	Spare part	
Unidirectional, standard prism	1	1	SP.AS00018-UNG
Unidirectional, reinforced prism	1	1	SP.AS00018-UNS

Top Cover assemblies, 12-inch, <u>with</u> heater	Quantity per		Spare part code
	Fitting	Spare part	
Unidirectional, standard prism, non-monitored (S-BAP) & EQ (R)	1	1	SP.AS00018-UAG
Unidirectional, reinforced prism, non-monitored (S-BAP) & EQ (R)	1	1	SP.AS00018-UAS
Unidirectional, standard prism, non-monitored (S-non BAP)	1	1	SP.AS00018-UBG
Unidirectional, reinforced prism, non-monitored (S-non BAP)	1	1	SP.AS00018-UBS

Top cover assemblies, 8-inch (2-bolt), <u>without</u> heater	Quantity per		Spare part code
	Fitting	Spare part	
Unidirectional, standard prism	1	1	SP.AS00019-3NG
Unidirectional, reinforced prism	1	1	SP.AS00019-3NS

Top cover assemblies, 8-inch (2-bolt), <u>with</u> heater	Quantity per		Spare part code
	Fitting	Spare part	
Unidirectional, standard prism, EQ (R)	1	1	SP.AS00019-3AG
Unidirectional, reinforced prism, EQ (R)	1	1	SP.AS00019-3AS
Unidirectional, standard prism, non-monitored (S-non BAP)	1	1	SP.AS00019-3BG
Unidirectional, reinforced prism, non-monitored (S-non BAP)	1	1	SP.AS00019-3BS

Top cover assemblies, 8-inch (4-bolt), <u>without</u> heater	Quantity per		Spare part code
	Fitting	Spare part	
Unidirectional, standard prism	1	1	SP.AS00019-5NG
Unidirectional, reinforced prism	1	1	SP.AS00019-5NS

Top cover assemblies, 8-inch (4-bolt), <u>with</u> heater	Quantity per		Spare part code
	Fitting	Spare part	
Unidirectional, standard prism, non-monitored (S-BAP) & EQ (R)	1	1	SP.AS00019-5AG
Unidirectional, reinforced prism, non-monitored (S-BAP) & EQ (R)	1	1	SP.AS00019-5AS
Unidirectional, standard prism, non-monitored (S-non-BAP)	1	1	SP.AS00019-5BG
Unidirectional, reinforced prism, non-monitored (S-non-BAP)	1	1	SP.AS00019-5BS

Light engine assemblies, 12-inch	Quantity per		Spare part code
	Fitting	Spare part	
FAA L-852G(L), yellow	1	1	SP.AS00023-GY2
IR sensor optic, autonomous RGL	1	1	SP.AS00277-012

Light engine assemblies, 8-inch	Quantity per		Spare part code
	Fitting	Spare part	
FAA L-852G(L), yellow	1	1	SP.AS00020-GY2
IR sensor optic, autonomous RGL	1	1	SP.AS00277-008

Bottom pan assemblies, 12-inch	Quantity per		Spare part code
	Fitting	Spare part	
Non-monitored converter, style 6 cord set	1	1	SP.AS00024-L13
Non-monitored converter, 3-pole cord set	1	1	SP.AS00024-L1F
Non-monitored converter, style 1 SJO jacketed cord set	1	1	SP.AS00024-L1J
EQ converter, style 6 cord set	1	1	SP.AS00024-R13
EQ converter, 3-pole cord set	1	1	SP.AS00024-R1F
EQ converter, style 1 SJO jacketed cord set	1	1	SP.AS00024-R1J

Bottom pan assemblies, 8-inch	Quantity per		Spare part code
	Fitting	Spare part	
Non-monitored converter, style 6 cord set	1	1	SP.AS00021-L13
Non-monitored converter, 3-pole cord set	1	1	SP.AS00021-L1F
Non-monitored converter, style 1 SJO jacketed cord set	1	1	SP.AS00021-L1J
EQ converter, style 6 cord set	1	1	SP.AS00021-R13
EQ converter, 3-pole cord set	1	1	SP.AS00021-R1F
EQ converter, style 1 SJO jacketed cord set	1	1	SP.AS00021-R1J

Cord sets	Quantity per		Spare part code
	Fitting	Spare part	
L-823 style 1, 8-inch bottom pan	1 or 2	5	SP.73A0193/1
L-823 style 1, 12-inch bottom pan	1 or 2	5	SP.73A0194/1
L-823 style 6, bottom pan	1 or 2	5	SP.73A0136/18
3-pole, bottom pan	1 or 2	5	SP.SGEFR500160
Cable retaining clamp, for style 1 cord set	1 or 2	5	SP.MB00003-013-01
Ground lug kit	1	5	SP.72A0401
Grounding kit style 6 (bolt & washer)	1 or 2	100	SP00102-100-01

Prism kits	Quantity per		Spare part code
	Fitting	Spare part	
Prism kit, runway standard, package of 2	1 or 2	2	SP.MG00001-G00-03
Prism kit, runway reinforced, package of 2	1 or 2	2	SP.MG00001-S00-03
Prism gaskets, runway, package of 10	1 or 2	10	SP.MS00004-000-02

Screws & gaskets	Quantity per		Spare part code
	Fitting	Spare part	
Screws, pressure release with o-ring, package of 5	1	5	SP.MF00090-000-01
Gaskets, 8-inch bottom pan, package of 10	1	10	SP.MS00005-000-01
Gaskets, 12-inch bottom pan, package of 10	1	10	SP.MS00006-000-01
Screws, bottom pan, package of 100	-	100	SP.MFPM5PT-714-01
Screws, 12-inch bottom pan, package of 100	-	100	SP.MFPM6PT-720-01
Screws, mounting light engine assemblies, package of 100	-	100	SP.MFPM4PT-710-01

Heater kits	Quantity per		Spare part code
	Fitting	Spare part	
Non-monitored (S-BAP) & EQ, with harness	1 or 2	2	SP.EP00038-R00-01
Non-monitored (S-non-BAP) & monitored, with harness	1 or 2	2	SP.EP00038-R01-01

Wire harnesses	Quantity per		Spare part code
	Fitting	Spare part	
Power supply to 8-inch light engine, package of 10	1 or 2	10	SP.EW00079-150-01
Power supply to 12-inch light engine, package of 10	1 or 2	10	SP.EW00079-300-01



Note

Component availability or design may be subject to change due to unforeseen circumstances. This document is subject to change or new information from ADB SAFEGATE, as and when available or if required, with reservation for error or price changes.

For more information or assistance with ordering spare parts, contact ADB SAFEGATE, see www.adbsafegate.com.

9.8 FAA L-850D(L) Runway Threshold and Threshold/End; ICAO and FAA Runway End



Note

- Each top cover and bottom pan assembly includes a gasket and screws for the bottom pan.
- Each light engine and heater kit assembly includes mounting screws.
- Each prism kit includes prism, gasket, protection plate (if applicable) and mounting screws.
- BAP stands for "buy American preference".

Top cover assemblies, 12-inch, without heater	Quantity per		Spare part code
	Fitting	Spare part	
Unidirectional, standard prism	1	1	SP.AS00018-UNG
Unidirectional, reinforced prism	1	1	SP.AS00018-UNS
Bidirectional, standard prism	1	1	SP.AS00018-BNG
Bidirectional, reinforced prism	1	1	SP.AS00018-BNS

Top Cover assemblies, 12-inch, with heater	Quantity per		Spare part code
	Fitting	Spare part	
Unidirectional, standard prism, non-monitored (S-BAP) & EQ (R)	1	1	SP.AS00018-UAG
Unidirectional, reinforced prism, non-monitored (S-BAP) & EQ (R)	1	1	SP.AS00018-UAS
Unidirectional, standard prism, non-monitored (S-non-BAP) & monitored (M)	1	1	SP.AS00018-UBG
Unidirectional, reinforced prism, non-monitored (S-non-BAP) & monitored (M)	1	1	SP.AS00018-UBS
Bidirectional, standard prism, non-monitored (S-BAP) & EQ (R)	1	1	SP.AS00018-BAG
Bidirectional, reinforced prism, non-monitored (S-BAP) & EQ (R)	1	1	SP.AS00018-BAS
Bidirectional, standard prism, non-monitored (S-non-BAP) & monitored (M)	1	1	SP.AS00018-BBG
Bidirectional, reinforced prism, non-monitored (S-non-BAP) & monitored (M)	1	1	SP.AS00018-BBS

Light engine assemblies, 12-inch	Quantity per		Spare part code
	Fitting	Spare part	
Threshold, FAA L-850D(L), F-green, left toe	1	1	SP.AS00023-LF2-RT
Threshold, FAA L-850D(L), F-green, straight	1	1	SP.AS00023-SF2
Threshold, FAA L-850D(L), F-green, right toe	1	1	SP.AS00023-RF2-RT
Runway end, ICAO & FAA L-850D(L), red, straight	1 or 2	1	SP.AS00023-SR3

Bottom pan assemblies, 12-inch	Quantity per		Spare part code
	Fitting	Spare part	
Non-monitored converter, style 6 cord set	1	1	SP.AS00024-L13
Non-monitored converter, style 1 SJO jacketed cord set	1	1	SP.AS00024-L1J
Non-monitored converter, 2-con style 6 cord set	1	1	SP.AS00024-L23
Non-monitored converter, 2-con style 1 SJO jacketed cord set	1	1	SP.AS00024-L2J
Monitored converter, style 6 cord set	1	1	SP.AS00024-M13
Monitored converter, style 1 SJO jacketed cord set	1	1	SP.AS00024-M1J
Monitored converter, 2-con style 6 cord sets	1	1	SP.AS00024-M23
Monitored converter, 2-con style 1 SJO jacketed cord sets	1	1	SP.AS00024-M2J
EQ converter, style 6 cord set	1	1	SP.AS00024-R13
EQ converter, style 1 SJO jacketed cord set	1	1	SP.AS00024-R1J

Cord sets	Quantity per		Spare part code
	Fitting	Spare part	
L-823 style 1, 12-inch bottom pan	1 or 2	5	SP.73A0194/1
L-823 style 6, bottom pan	1 or 2	5	SP.73A0136/18
Cable retaining clamp, for style 1 cord set	1 or 2	5	SP.MB00003-013-01
Ground lug kit	1	5	SP.72A0401
Grounding kit style 6 (bolt & washer)	1 or 2	100	SP00102-100-01

Prism kits	Quantity per		Spare part code
	Fitting	Spare part	
Prism kit, runway standard, package of 2	1 or 2	2	SP.MG00001-G00-03
Prism kit, runway reinforced, package of 2	1 or 2	2	SP.MG00001-S00-03
Prism gaskets, runway, package of 10	1 or 2	10	SP.MS00004-000-02

Screws & gaskets	Quantity per		Spare part code
	Fitting	Spare part	
Screws, pressure release with o-ring, package of 5	1	5	SP.MF00090-000-01
Gaskets, 12-inch bottom pan, package of 10	1	10	SP.MS00006-000-01
Screws, mounting light engine assemblies, package of 100	-	100	SP.MFPM4PT-710-01
Screws, 12-inch bottom pan, package of 100	-	100	SP.MFPM6PT-720-01

Heater kits	Quantity per		Spare part code
	Fitting	Spare part	
Non-monitored (S-BAP) & EQ, with harness	1 or 2	2	SP.EP00038-R00-01
Non-monitored (S-non-BAP) & monitored, with harness	1 or 2	2	SP.EP00038-R01-01

Wire harnesses	Quantity per		Spare part code
	Fitting	Spare part	
Power supply to 12-inch light engine, package of 10	1 or 2	10	SP.EW00079-300-01

Fuse resistors - only for fixtures with monitoring (M)	Quantity per		Spare part code
	Fitting	Spare part	
For use with legacy converters	1 or 2	20	SP.6132.00.250
For use with new style mon converters	1 or 2	20	SP.EZ00015-000-01



Note

Component availability or design may be subject to change due to unforeseen circumstances. This document is subject to change or new information from ADB SAFEGATE, as and when available or if required, with reservation for error or price changes.

For more information or assistance with ordering spare parts, contact ADB SAFEGATE, see www.adbsafegate.com.

9.9 ICAO Stopway ≤ 45 m Width Runway



Note

- Each top cover and bottom pan assembly includes a gasket and screws for the bottom pan.
- Each light engine and heater kit assembly includes mounting screws.
- Each prism kit includes prism, gasket, protection plate (if applicable) and mounting screws.
- BAP stands for "buy American preference".

Top cover assemblies, 12-inch, without heater	Quantity per		Spare part code
	Fitting	Spare part	
Unidirectional, standard prism	1	1	SP.AS00018-UNG
Unidirectional, reinforced prism	1	1	SP.AS00018-UNS

Top Cover assemblies, 12-inch, with heater	Quantity per		Spare part code
	Fitting	Spare part	
Unidirectional, standard prism, EQ (R)	1	1	SP.AS00018-UAG
Unidirectional, reinforced prism, EQ (R)	1	1	SP.AS00018-UAS
Unidirectional, standard prism, non-monitored & monitored (M)	1	1	SP.AS00018-UBG
Unidirectional, reinforced prism, non-monitored & monitored (M)	1	1	SP.AS00018-UBS

Light engine assemblies, 12-inch	Quantity per		Spare part code
	Fitting	Spare part	
Runway edge / stopway 45m, red, left toe	1	1	SP.AS00023-LR2
Runway edge / stopway 45m, red, right toe	1	1	SP.AS00023-RR2

Bottom pan assemblies, 12-inch	Quantity per		Spare part code
	Fitting	Spare part	
Non-monitored converter, style 6 cord set	1	1	SP.AS00024-L13
Non-monitored converter, 3-pole cord set	1	1	SP.AS00024-L1F
Non-monitored converter, style 1 SJO jacketed cord set	1	1	SP.AS00024-L1J
Monitored converter, style 6 cord set	1	1	SP.AS00024-M13
Monitored converter, 3-pole cord set	1	1	SP.AS00024-M1F
Monitored converter, style 1 SJO jacketed cord set	1	1	SP.AS00024-M1J
EQ converter, style 6 cord set	1	1	SP.AS00024-R13
EQ converter, 3-pole cord set	1	1	SP.AS00024-R1F
EQ converter, style 1 SJO jacketed cord set	1	1	SP.AS00024-R1J

Cord sets	Quantity per		Spare part code
	Fitting	Spare part	
L-823 style 1, 12-inch bottom pan	1 or 2	5	SP.73A0194/1
L-823 style 6, bottom pan	1 or 2	5	SP.73A0136/18
3-pole, bottom pan	1 or 2	5	SP.SGEFR500160
Cable retaining clamp, for style 1 cord set	1 or 2	5	SP.MB00003-013-01
Ground lug kit	1	5	SP.72A0401
Grounding kit style 6 (bolt & washer)	1 or 2	100	SP00102-100-01

Prism kits	Quantity per		Spare part code
	Fitting	Spare part	
Prism kit, runway standard, package of 2	1 or 2	2	SP.MG00001-G00-03
Prism kit, runway reinforced, package of 2	1 or 2	2	SP.MG00001-S00-03
Prism gaskets, runway, package of 10	1 or 2	10	SP.MS00004-000-02

Screws & gaskets	Quantity per		Spare part code
	Fitting	Spare part	
Screws, pressure release with o-ring, package of 5	1	5	SP.MF00090-000-01
Gaskets, 12-inch bottom pan, package of 10	1	10	SP.MS00006-000-01
Screws, mounting light engine assemblies, package of 100	-	100	SP.MFPM4PT-710-01
Screws, 12-inch bottom pan, package of 100	-	100	SP.MFPM6PT-720-01

Heater kits	Quantity per		Spare part code
	Fitting	Spare part	
EQ, with harness	1 or 2	2	SP.EP00038-R00-01
Non-monitored & monitored with harness	1 or 2	2	SP.EP00038-R01-01

Wire harnesses	Quantity per		Spare part code
	Fitting	Spare part	
Power supply to 12-inch light engine, package of 10	1 or 2	10	SP.EW00079-300-01

Fuse resistors - only for fixtures with monitoring (M)	Quantity per		Spare part code
	Fitting	Spare part	
For use with legacy converters	1 or 2	20	SP.6132.00.250
For use with new style mon converters	1 or 2	20	SP.EZ00015-000-01



Note

Component availability or design may be subject to change due to unforeseen circumstances. This document is subject to change or new information from ADB SAFEGATE, as and when available or if required, with reservation for error or price changes.

For more information or assistance with ordering spare parts, contact ADB SAFEGATE, see www.adbsafegate.com.

9.10 RWSL L-850T(L) Runway Takeoff/Hold and Intersection Light (THL/RIL)



Note

- Each top cover and bottom pan assembly includes a gasket and screws for the bottom pan.
- Each light engine and heater kit assembly includes mounting screws.
- Each prism kit includes prism, gasket, protection plate (if applicable) and mounting screws.
- BAP stands for "buy American preference".

Top cover assemblies, 12-inch, without heater	Quantity per		Spare part code
	Fitting	Spare part	
Unidirectional, standard prism	1	1	SP.AS00018-UNG
Unidirectional, reinforced prism	1	1	SP.AS00018-UNS

Top Cover assemblies, 12-inch, with heater	Quantity per		Spare part code
	Fitting	Spare part	
Unidirectional, standard prism, EQ (R)	1	1	SP.AS00018-UAG
Unidirectional, reinforced prism, EQ (R)	1	1	SP.AS00018-UAS

Top cover assemblies, 8-inch (2-bolt), without heater	Quantity per		Spare part code
	Fitting	Spare part	
Unidirectional, standard prism	1	1	SP.AS00019-3NG
Unidirectional, reinforced prism	1	1	SP.AS00019-3NS

Top cover assemblies, 8-inch (2-bolt), with heater	Quantity per		Spare part code
	Fitting	Spare part	
Unidirectional, standard prism, EQ (R)	1	1	SP.AS00019-3AG
Unidirectional, reinforced prism, EQ (R)	1	1	SP.AS00019-3AS

Top cover assemblies, 8-inch (4-bolt), without heater	Quantity per		Spare part code
	Fitting	Spare part	
Unidirectional, standard prism	1	1	SP.AS00019-5NG
Unidirectional, reinforced prism	1	1	SP.AS00019-5NS

Top cover assemblies, 8-inch (4-bolt), with heater	Quantity per		Spare part code
	Fitting	Spare part	
Unidirectional, standard prism, EQ (R)	1	1	SP.AS00019-5AG
Unidirectional, reinforced prism, EQ (R)	1	1	SP.AS00019-5AS

Light engine assemblies, 12-inch	Quantity per		Spare part code
	Fitting	Spare part	
Runway status take-off / hold, red	1	1	SP.AS00023-SR2

Light engine assemblies, 8-inch	Quantity per		Spare part code
	Fitting	Spare part	
Runway status take-off / hold, red	1	1	SP.AS00020-SR2

Bottom pan assemblies, 12-inch	Quantity per		Spare part code
	Fitting	Spare part	
RWSL EQ converter, style 1 SJO jacketed cord set	1	1	SP.AS00024-R1R
Bottom pan assemblies, 8-inch	Quantity per		Spare part code
	Fitting	Spare part	
RWSL EQ converter, style 1 SJO jacketed cord set	1	1	SP.AS00021-R1R
Cord sets	Quantity per		Spare part code
	Fitting	Spare part	
L-823 style 1, 8-inch bottom pan	1 or 2	5	SP.73A0193/1
L-823 style 1, 12-inch bottom pan	1 or 2	5	SP.73A0194/1
Cable retaining clamp, for style 1 cord set	1 or 2	5	SP.MB00003-013-01
Ground lug kit	1	5	SP.72A0401
Grounding kit style 6 (bolt & washer)	1 or 2	100	SP00102-100-01
Prism kits	Quantity per		Spare part code
	Fitting	Spare part	
Prism kit, runway standard, package of 2	1 or 2	2	SP.MG00001-G00-03
Prism kit, runway reinforced, package of 2	1 or 2	2	SP.MG00001-S00-03
Prism gaskets, runway, package of 10	1 or 2	10	SP.MS00004-000-02
Screws & gaskets	Quantity per		Spare part code
	Fitting	Spare part	
Screws, pressure release with o-ring, package of 5	1	5	SP.MF00090-000-01
Gaskets, 8-inch bottom pan, package of 10	1	10	SP.MS00005-000-01
Gaskets, 12-inch bottom pan, package of 10	1	10	SP.MS00006-000-01
Screws, bottom pan, package of 100	-	100	SP.MFPM5PT-714-01
Screws, 12-inch bottom pan, package of 100	-	100	SP.MFPM6PT-720-01
Screws, mounting light engine assemblies, package of 100	-	100	SP.MFPM4PT-710-01
Heater kits	Quantity per		Spare part code
	Fitting	Spare part	
EQ, with harness	1 or 2	2	SP.EP00038-R00-01
Wire harnesses	Quantity per		Spare part code
	Fitting	Spare part	
Power supply to 8-inch light engine, package of 10	1 or 2	10	SP.EW00079-150-01
Power supply to 12-inch light engine, package of 10	1 or 2	10	SP.EW00079-300-01



Note

Component availability or design may be subject to change due to unforeseen circumstances. This document is subject to change or new information from ADB SAFEGATE, as and when available or if required, with reservation for error or price changes.

For more information or assistance with ordering spare parts, contact ADB SAFEGATE, see www.adbsafegate.com.

9.11 ICAO Rapid Exit Taxiway Indicator Light (RETIL)



Note

- Each top cover and bottom pan assembly includes a gasket and screws for the bottom pan.
- Each light engine and heater kit assembly includes mounting screws.
- Each prism kit includes prism, gasket, protection plate (if applicable) and mounting screws.
- BAP stands for "buy American preference".

Top cover assemblies, 12-inch, <u>without</u> heater	Quantity per		Spare part code
	Fitting	Spare part	
Unidirectional, standard prism	1	1	SP.AS00018-UNG
Unidirectional, reinforced prism	1	1	SP.AS00018-UNS

Top Cover assemblies, 12-inch, <u>with</u> heater	Quantity per		Spare part code
	Fitting	Spare part	
Unidirectional, standard prism, EQ (R)	1	1	SP.AS00018-UAG
Unidirectional, reinforced prism, EQ (R)	1	1	SP.AS00018-UAS
Unidirectional, standard prism, monitored (M)	1	1	SP.AS00018-UBG
Unidirectional, reinforced prism, monitored (M)	1	1	SP.AS00018-UBS

Top cover assemblies, 8-inch (2-bolt), <u>without</u> heater	Quantity per		Spare part code
	Fitting	Spare part	
Unidirectional, standard prism	1	1	SP.AS00019-3NG
Unidirectional, reinforced prism	1	1	SP.AS00019-3NS

Top cover assemblies, 8-inch (2-bolt), <u>with</u> heater	Quantity per		Spare part code
	Fitting	Spare part	
Unidirectional, standard prism, EQ (R)	1	1	SP.AS00019-3AG
Unidirectional, reinforced prism, EQ (R)	1	1	SP.AS00019-3AS
Unidirectional, standard prism, monitored (M)	1	1	SP.AS00019-3BG
Unidirectional, reinforced prism, monitored (M)	1	1	SP.AS00019-3BS

Light engine assemblies, 12-inch	Quantity per		Spare part code
	Fitting	Spare part	
ICAO RETIL, yellow	1	1	SP.AS00023-SY1

Light engine assemblies, 8-inch	Quantity per		Spare part code
	Fitting	Spare part	
ICAO RETIL, yellow	1	1	SP.AS00020-SY1

Bottom pan assemblies, 12-inch	Quantity per		Spare part code
	Fitting	Spare part	
Monitored converter, style 6 cord set	1	1	SP.AS00024-M13
Monitored converter, 3-pole cord set	1	1	SP.AS00024-M1F
Monitored converter, style 1 SJO jacketed cord set	1	1	SP.AS00024-M1J
EQ converter, style 6 cord set	1	1	SP.AS00024-R13
EQ converter, 3-pole cord set	1	1	SP.AS00024-R1F
EQ converter, style 1 SJO jacketed cord set	1	1	SP.AS00024-R1J

Bottom pan assemblies, 8-inch	Quantity per		Spare part code
	Fitting	Spare part	
Monitored converter, style 6 cord set	1	1	SP.AS00021-M13
Monitored converter, 3-pole cord set	1	1	SP.AS00021-M1F
Monitored converter, style 1 SJO jacketed cord set	1	1	SP.AS00021-M1J
EQ converter, style 6 cord set	1	1	SP.AS00021-R13
EQ converter, 3-pole cord set	1	1	SP.AS00021-R1F
EQ converter, style 1 SJO jacketed cord set	1	1	SP.AS00021-R1J

Cord sets	Quantity per		Spare part code
	Fitting	Spare part	
L-823 style 1, 8-inch bottom pan	1 or 2	5	SP.73A0193/1
L-823 style 1, 12-inch bottom pan	1 or 2	5	SP.73A0194/1
L-823 style 6, bottom pan	1 or 2	5	SP.73A0136/18
3-pole, bottom pan	1 or 2	5	SP.SGFR500160
Cable retaining clamp, for style 1 cord set	1 or 2	5	SP.MB00003-013-01
Ground lug kit	1	5	SP.72A0401
Grounding kit style 6 (bolt & washer)	1 or 2	100	SP00102-100-01

Prism kits	Quantity per		Spare part code
	Fitting	Spare part	
Prism kit, runway standard, package of 2	1 or 2	2	SP.MG00001-G00-03
Prism kit, runway reinforced, package of 2	1 or 2	2	SP.MG00001-S00-03
Prism gaskets, runway, package of 10	1 or 2	10	SP.MS00004-000-02

Screws & gaskets	Quantity per		Spare part code
	Fitting	Spare part	
Screws, pressure release with o-ring, package of 5	1	5	SP.MF00090-000-01
Gaskets, 8-inch bottom pan, package of 10	1	10	SP.MS00005-000-01
Gaskets, 12-inch bottom pan, package of 10	1	10	SP.MS00006-000-01
Screws, bottom pan, package of 100	-	100	SP.MFPM5PT-714-01
Screws, 12-inch bottom pan, package of 100	-	100	SP.MFPM6PT-720-01
Screws, mounting light engine assemblies, package of 100	-	100	SP.MFPM4PT-710-01

Heater kits	Quantity per		Spare part code
	Fitting	Spare part	
EQ, with harness	1 or 2	2	SP.EP00038-R00-01
Monitored with harness	1 or 2	2	SP.EP00038-R01-01

Wire harnesses	Quantity per		Spare part code
	Fitting	Spare part	
Power supply to 8-inch light engine, package of 10	1 or 2	10	SP.EW00079-150-01
Power supply to 12-inch light engine, package of 10	1 or 2	10	SP.EW00079-300-01

Fuse resistors - only for fixtures with monitoring (M)	Quantity per		Spare part code
	Fitting	Spare part	
For use with legacy converters	1 or 2	20	SP.6132.00.250
For use with new style mon converters	1 or 2	20	SP.EZ00015-000-01



Note

Component availability or design may be subject to change due to unforeseen circumstances. This document is subject to change or new information from ADB SAFEGATE, as and when available or if required, with reservation for error or price changes.

For more information or assistance with ordering spare parts, contact ADB SAFEGATE, see www.adbsafegate.com.

9.12 ICAO Stopway ≤ 60 m Width Runway



Note

- Each top cover and bottom pan assembly includes a gasket and screws for the bottom pan.
- Each light engine and heater kit assembly includes mounting screws.
- Each prism kit includes prism, gasket, protection plate (if applicable) and mounting screws.
- BAP stands for "buy American preference".

Top cover assemblies, 12-inch, without heater	Quantity per		Spare part code
	Fitting	Spare part	
Unidirectional, standard prism	1	1	SP.AS00018-UNG
Unidirectional, reinforced prism	1	1	SP.AS00018-UNS

Top Cover assemblies, 12-inch, with heater	Quantity per		Spare part code
	Fitting	Spare part	
Unidirectional, standard prism, EQ (R)	1	1	SP.AS00018-UAG
Unidirectional, reinforced prism, EQ (R)	1	1	SP.AS00018-UAS
Unidirectional, standard prism, monitored (M)	1	1	SP.AS00018-UBG
Unidirectional, reinforced prism, monitored (M)	1	1	SP.AS00018-UBS

Light engine assemblies, 12-inch	Quantity per		Spare part code
	Fitting	Spare part	
Runway / stopway edge 60m, red, left toe	1	1	SP.AS00023-6R2
Runway edge 60m, white, right toe	1	1	SP.AS00023-7W1

Bottom pan assemblies, 12-inch	Quantity per		Spare part code
	Fitting	Spare part	
Non-monitored converter, style 6 cord set	1	1	SP.AS00024-L13
Non-monitored converter, 3-pole cord set	1	1	SP.AS00024-L1F
Non-monitored converter, style 1 SJO jacketed cord set	1	1	SP.AS00024-L1J
Monitored converter, style 6 cord set	1	1	SP.AS00024-M13
Monitored converter, 3-pole cord set	1	1	SP.AS00024-M1F
Monitored converter, style 1 SJO jacketed cord set	1	1	SP.AS00024-M1J
EQ converter, style 6 cord set	1	1	SP.AS00024-R13
EQ converter, 3-pole cord set	1	1	SP.AS00024-R1F
EQ converter, style 1 SJO jacketed cord set	1	1	SP.AS00024-R1J

Cord sets	Quantity per		Spare part code
	Fitting	Spare part	
L-823 style 1, 12-inch bottom pan	1 or 2	5	SP.73A0194/1
L-823 style 6, bottom pan	1 or 2	5	SP.73A0136/18
3-pole, bottom pan	1 or 2	5	SP.SGEFR500160
Cable retaining clamp, for style 1 cord set	1 or 2	5	SP.MB00003-013-01
Ground lug kit	1	5	SP.72A0401
Grounding kit style 6 (bolt & washer)	1 or 2	100	SP00102-100-01

Prism kits	Quantity per		Spare part code
	Fitting	Spare part	
Prism kit, runway standard, package of 2	1 or 2	2	SP.MG00001-G00-03
Prism kit, runway reinforced, package of 2	1 or 2	2	SP.MG00001-S00-03
Prism gaskets, runway, package of 10	1 or 2	10	SP.MS00004-000-02

Screws & gaskets	Quantity per		Spare part code
	Fitting	Spare part	
Screws, pressure release with o-ring, package of 5	1	5	SP.MF00090-000-01
Gaskets, 12-inch bottom pan, package of 10	1	10	SP.MS00006-000-01
Screws, mounting light engine assemblies, package of 100	-	100	SP.MFPM4PT-710-01
Screws, 12-inch bottom pan, package of 100	-	100	SP.MFPM6PT-720-01

Heater kits	Quantity per		Spare part code
	Fitting	Spare part	
EQ, with harness	1 or 2	2	SP.EP00038-R00-01
Non-monitored & monitored with harness	1 or 2	2	SP.EP00038-R01-01

Wire harnesses	Quantity per		Spare part code
	Fitting	Spare part	
Power supply to 12-inch light engine, package of 10	1 or 2	10	SP.EW00079-300-01

Fuse resistors - only for fixtures with monitoring (M)	Quantity per		Spare part code
	Fitting	Spare part	
For use with legacy converters	1 or 2	20	SP.6132.00.250
For use with new style mon converters	1 or 2	20	SP.EZ00015-000-01



Note

Component availability or design may be subject to change due to unforeseen circumstances. This document is subject to change or new information from ADB SAFEGATE, as and when available or if required, with reservation for error or price changes.

For more information or assistance with ordering spare parts, contact ADB SAFEGATE, see www.adbsafegate.com.

10.0 Power Tables

L-850A(L) Runway Centerline and L-850B(L) Touchdown Zone

8-inch and 12-inch light fixtures without Arctic Kit (heater)

Fixture type - 1 cord set ¹	Fixture load	Isolation transformer		CCR load
		Wattage	Load	
Runway centerline, L-850A(L), bidirectional	34.9 VA	45 W	14.2 VA	49.1 VA
Touchdown zone, L-850B(L), unidirectional	25.5 VA	25 W	7.2 VA	32.7 VA

8-inch and 12-inch light fixtures with Arctic Kit (heater)

Fixture Types - 1 cord set ¹	Fixture load	Isolation transformer		CCR load
		Wattage	Load	
Runway centerline, L-850A(L), bidirectional	62.6 VA	65 W	16.6 VA	79.2 VA
Touchdown zone, L-850B(L), unidirectional	48.8 VA	45 W	9.7 VA	58.5 VA

¹Values provided are for the "S" option non-monitored power only.



Note

- EQ fixtures:
 - The isolation transformer must have an additional 8 VA available above the fixture load for communication bandwidth. Size transformer to next size up to assure additional 8 VA coverage
 - Legacy BRITE II or AGLAS 2 systems — Order "M" power supply
- Fail-open fixtures:
 - The maximum rating for the isolation transformer is 150 W (a correctly calibrated CCR is important to achieve an accurate fail open response)
- Additional voltage loss not included in the above table which must be factored into the circuit load calculation:
 - Primary cables will result in a higher CCR load
 - Longer secondary cables may result in a larger size isolation transformer requirement
- Efficiency of the isolation transformer depends on the manufacturer of the transformer

LED L-850C(L) Runway Edge ≤ 45 m Width Runway

12-inch light fixtures without Arctic Kit (heater)

Fixture type – 1 cord set ¹	Fixture load	Isolation transformer		CCR load
		Wattage	Load	
Runway edge, L-850C(L), bidirectional	50 VA	65 W	13 VA	63 VA

12-inch light fixtures with Arctic Kit (heater)

Fixture type – 1 cord set ¹	Fixture load	Isolation transformer		CCR load
		Wattage	Load	
Runway edge, L-850C(L), bidirectional	71.6 VA	65 W	15.7 VA	87.3 VA

¹Values provided are for the "S" option non-monitored power only.



Note

- EQ fixtures:
 - The isolation transformer must have an additional 8 VA available above the fixture load for communication bandwidth. Size transformer to next size up to assure additional 8 VA coverage
 - Legacy BRITE II or AGLAS 2 systems — Order "M" power supply
- Fail-open fixtures:
 - The maximum rating for the isolation transformer is 150 W (a correctly calibrated CCR is important to achieve an accurate fail open response)
- Additional voltage loss not included in the above table which must be factored into the circuit load calculation:
 - Primary cables will result in a higher CCR load
 - Longer secondary cables may result in a larger size isolation transformer requirement
- Efficiency of the isolation transformer depends on the manufacturer of the transformer

ICAO Runway Edge ≤ 60 m Width Runway

12-inch light fixtures without Arctic Kit (heater)

Fixture type - 1 cord set ¹	Fixture load	Isolation transformer		CCR load
		Wattage	Load	
Runway edge, bidirectional, white/white	50 VA	65 W	13 VA	63 VA
Runway edge, unidirectional, white	30 VA	45 W	10 VA	40 VA

12-inch light fixtures with Arctic Kit (heater)

Fixture Types - 1 cord set ¹	Fixture load	Isolation transformer		CCR load
		Wattage	Load	
Runway edge, bidirectional, white/red	72 VA	65 W	15 VA	87 VA
Runway edge, unidirectional, red	40 VA	45 W	10 VA	50 VA

¹Values provided are for the "S" option non-monitored power only.



Note

- EQ fixtures:
 - The isolation transformer must have an additional 8 VA available above the fixture load for communication bandwidth. Size transformer to next size up to assure additional 8 VA coverage
 - Legacy BRITE II or AGLAS 2 systems — Order "M" power supply
- Fail-open fixtures:
 - The maximum rating for the isolation transformer is 150 W (a correctly calibrated CCR is important to achieve an accurate fail open response)
- Additional voltage loss not included in the above table which must be factored into the circuit load calculation:
 - Primary cables will result in a higher CCR load
 - Longer secondary cables may result in a larger size isolation transformer requirement
- Efficiency of the isolation transformer depends on the manufacturer of the transformer

FAA L-852G(L) Runway Guard Light

8-inch and 12-inch light fixtures without Arctic Kit (heater)

Fixture type – 1 cord set ¹	Fixture load	Isolation transformer		CCR load
		Wattage	Load	
Runway guard light, L-852(L), autonomous	26 VA	25 W	8 VA	34 VA
Runway guard light, L-852(L), EQ / LINC 360	28 VA	45 W	10 VA	38 VA

8 and 12-inch light fixtures with Arctic Kit (heater)

Fixture type – 1 cord set ¹	Fixture load	Isolation transformer		CCR load
		Wattage	Load	
Runway guard light, L-852(L), autonomous	43 VA	45 W	9 VA	52 VA
Runway guard light, L-852(L), EQ / LINC 360	45 VA	45 W	9 VA	54 VA

¹Values provided are for the "S" option non-monitored power only.



Note

- EQ fixtures:
 - The isolation transformer must have an additional 8 VA available above the fixture load for communication bandwidth. Size transformer to next size up to assure additional 8 VA coverage
 - Legacy BRITE II or AGLAS 2 systems — Order "M" power supply
- Fail-open fixtures:
 - The maximum rating for the isolation transformer is 150 W (a correctly calibrated CCR is important to achieve an accurate fail open response)
- Additional voltage loss not included in the above table which must be factored into the circuit load calculation:
 - Primary cables will result in a higher CCR load
 - Longer secondary cables may result in a larger size isolation transformer requirement
- Efficiency of the isolation transformer depends on the manufacturer of the transformer

FAA L-850D(L) Runway Threshold and Threshold/End; ICAO and FAA Runway End

12-inch light fixtures without arctic kit (heater)

Fixture type - 1 cord set ¹	Fixture load	Isolation transformer		CCR load
		Wattage	Load	
Runway threshold, L-850D(L), bidirectional, F-green/red	36.6 VA	45 W	14.2 VA	50.8 VA
Runway end, bidirectional, red/red	46.6 VA	45 W	13 VA	59.6 VA
Runway threshold, L-850D(L), unidirectional, F-green	21.2 VA	25 W	6.8 VA	28 VA
Runway end, unidirectional, red	31.6 VA	25 W	9.5 VA	41.1 VA

12-inch light fixtures with arctic kit (heater)

Fixture type - 1 cord set ¹	Fixture load	Isolation transformer		CCR load
		Wattage	Load	
Runway threshold, L-850D(L), bidirectional, F-green/red	65.3 VA	65 W	16.2 VA	81.5 VA

¹Values provided are for the "S" option non-monitored power only.



Note

- EQ fixtures:
 - The isolation transformer must have an additional 8 VA available above the fixture load for communication bandwidth. Size transformer to next size up to assure additional 8 VA coverage
 - Legacy BRITE II or AGLAS 2 systems — Order "M" power supply
- Fail-open fixtures:
 - The maximum rating for the isolation transformer is 150 W (a correctly calibrated CCR is important to achieve an accurate fail open response)
- Additional voltage loss not included in the above table which must be factored into the circuit load calculation:
 - Primary cables will result in a higher CCR load
 - Longer secondary cables may result in a larger size isolation transformer requirement
- Efficiency of the isolation transformer depends on the manufacturer of the transformer

ICAO Stopway ≤ 45 m Width Runway

12-inch light fixtures without Arctic Kit (heater)

Fixture type - 1 cord set ¹	Fixture load	Isolation transformer		CCR load
		Wattage	Load	
Stopway unidirectional	15 VA	45W	10 VA	25 VA

¹Values provided are for the "S" option non-monitored power only.



Note

- EQ fixtures:
 - The isolation transformer must have an additional 8 VA available above the fixture load for communication bandwidth. Size transformer to next size up to assure additional 8 VA coverage
 - Legacy BRITE II or AGLAS 2 systems — Order "M" power supply
- Fail-open fixtures:
 - The maximum rating for the isolation transformer is 150 W (a correctly calibrated CCR is important to achieve an accurate fail open response)
- Additional voltage loss not included in the above table which must be factored into the circuit load calculation:
 - Primary cables will result in a higher CCR load
 - Longer secondary cables may result in a larger size isolation transformer requirement
- Efficiency of the isolation transformer depends on the manufacturer of the transformer

LED RWSL: L-850T(L) Runway Takeoff/Hold and Intersection Light (THL/RIL) and L-852S(L) Runway Entry Light (REL)

8-inch and 12-inch light fixtures without Arctic Kit

Fixture type - 1 cord set ¹	Fixture load	Isolation transformer		CCR load
		Wattage	Load	
L-850T(L) runway takeoff/hold and intersection light (THL/RIL)	16.5 VA	25 W	10 VA	26.5 VA

8-inch and 12-inch light fixtures with Arctic Kit

Fixture type - 1 cord set ¹	Fixture load	Isolation transformer		CCR load
		Wattage	Load	
L-850T(L) runway takeoff/hold and intersection light (THL/RIL)	48.5 VA	65 W	14 VA	62.5 VA



Note

- EQ fixtures:
 - The isolation transformer must have an additional 8 VA available above the fixture load for communication bandwidth. Size transformer to next size up to assure additional 8 VA coverage
 - Legacy BRITE II or AGLAS 2 systems — Order "M" power supply
- Fail-open fixtures:
 - The maximum rating for the isolation transformer is 150 W (a correctly calibrated CCR is important to achieve an accurate fail open response)
- Additional voltage loss not included in the above table which must be factored into the circuit load calculation:
 - Primary cables will result in a higher CCR load
 - Longer secondary cables may result in a larger size isolation transformer requirement
- Efficiency of the isolation transformer depends on the manufacturer of the transformer

ICAO Rapid Exit Taxiway Indicator Light (RETIL)

8-inch and 12-inch light fixtures without Arctic Kit

Fixture type – 1 cord set ¹	Fixture load	Isolation transformer		CCR load
		Wattage	Load	
Rapid exit taxiway indicator light	20 VA	45 W	7.2 VA	27.2 VA



Note

- EQ fixtures:
 - The isolation transformer must have an additional 8 VA available above the fixture load for communication bandwidth. Size transformer to next size up to assure additional 8 VA coverage
 - Legacy BRITE II or AGLAS 2 systems — Order "M" power supply
 - Fail-open fixtures:
 - The maximum rating for the isolation transformer is 150 W (a correctly calibrated CCR is important to achieve an accurate fail open response)
 - Additional voltage loss not included in the above table which must be factored into the circuit load calculation:
 - Primary cables will result in a higher CCR load
 - Longer secondary cables may result in a larger size isolation transformer requirement
 - Efficiency of the isolation transformer depends on the manufacturer of the transformer
-

ICAO Stopway ≤ 60 m Width Runway

12-inch light fixtures without Arctic Kit (heater)

Fixture type - 1 cord set ¹	Fixture load	Isolation transformer		CCR load
		Wattage	Load	
Stopway unidirectional	15 VA	45 W	10 VA	25 VA



Note

- EQ fixtures:
 - The isolation transformer must have an additional 8 VA available above the fixture load for communication bandwidth. Size transformer to next size up to assure additional 8 VA coverage
 - Legacy BRITE II or AGLAS 2 systems — Order "M" power supply
- Fail-open fixtures:
 - The maximum rating for the isolation transformer is 150 W (a correctly calibrated CCR is important to achieve an accurate fail open response)
- Additional voltage loss not included in the above table which must be factored into the circuit load calculation:
 - Primary cables will result in a higher CCR load
 - Longer secondary cables may result in a larger size isolation transformer requirement
- Efficiency of the isolation transformer depends on the manufacturer of the transformer

Appendix A: INTEROPERABILITY – 12-inch and 8-inch

Base installation – O-ring selection and retaining bolts 12-inch

The O-ring is required for 12-inch light fixtures. For corresponding 12-inch base, refer to the ordering code in the data sheet.



CAUTION

Use of incorrect combination of gaskets, bolts and nuts can cause multiple safety risks and severe damage to product. To obtain a safe and watertight installation, the O-ring and retaining bolt stated in the document must be used. In order to choose the correct gasket, bolts and nuts, you need to know what base the light fixture will be installed in. **Failure to follow these precautions can result in equipment damage and/or aircraft FOD.**

Table 7: Interoperability matrix – 12-inch

Base type	Required O-ring	Bolt installation		Stud installation	
		Required dimension	Recommended torque ³	Required nut	Recommended torque ³
RELIANCE 12" 150 mm ERNI 12" ED12-190	O-ring D259, 3x5, 7 SP.013114/10pc SP.013115/100pc	1411.20.482 Metric screw kit 12" M10x25 mm	40 Nm+locking washer ²	1411.20.500 Self-locking nut kit 12" M10xH=100	35 Nm
Thorn 12" 150 mm			40 Nm+locking washer ²		35 Nm
12" Eurobase			21 Nm + Loctite 2701 or 638		21 Nm ¹
L-868 deep can with flange		1411.20.452 UNC screw kit	reference EB83	NA	NA

1. Do not use Loctite or washer with self-locking nut
2. Max height 2 mm
3. Do not use SO jacketed cord style 1



Note

If the use of Loctite is not necessary or obligatory, then it is recommended to use a suitable lubricant when fastening the bolts. Use nickel or graphite grease, but do NOT use copper-based grease as it stimulates corrosion.

Base installation – O-ring selection and retaining bolts 8-inch



CAUTION

Use of incorrect combination of gaskets, bolts and nuts can cause multiple safety risks and severe damage to product.

To obtain a safe and watertight installation, the O-ring and retaining bolt stated in the document must be used.

In order to choose the correct gasket, bolts and nuts, you need to know what base the light fixture will be installed in.

Failure to follow these precautions can result in equipment damage and/or aircraft FOD.

Table 8: Interoperability matrix – 8-inch

Base type	Required O-ring	Bolt installation		Stud installation	
		Required dimension	Recommended torque ³	Required nut	Recommended torque ³
RELIANCE 8" 135 mm Thorn 8" 100 mm Thorn 8" 133 mm IDM 6494 120 mm Adapter ring SG/Thorn/ID 8"-12"	Red O-Ring SGE.SP24523/10 pc SGE.SP24526/100 pc	1411.20.522 Metric screw kit 8" M10x25mm	40 Nm+locking washer ²	1411.20.430 Self-locking nut kit 8" M10xH100	35 Nm
ERNI 8" EE08 150 mm ERNI 8" ED08 133 mm	Blue O-Ring SGE.SP24521/10 pc SGE.SP24524/100 pc		21 Nm + Loctite 2701 or 638		
8" Eurobase Adapter ring ADB 8"-12"					
8" HPI	Grey O-Ring SGE.SP24522/10 pc SGE.SP24525/100 pc				

1. Do not use Loctite or washer with self-locking nut
2. Max height 2 mm
3. Do not use SO jacketed cord style 1

The pictures below show photos of the bases mentioned above and the frame shows the color of the intended gasket (o-ring).

Figure 70: Shallow bases

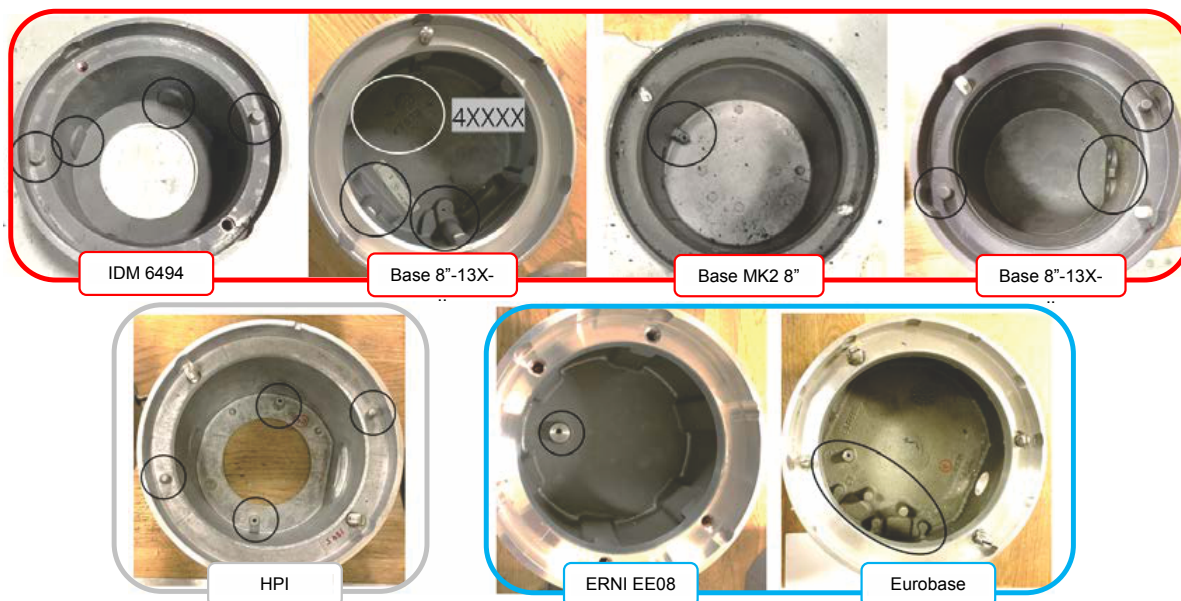

Appendix B: Cable Loss

The formula for measuring the cable resistance **R** (in ohms) for a single conductor is calculated with following formula:

$$R = \rho \times (L / A)$$

Where:

- **R** = resistance of the cable (in ohms, Ω)
- **ρ** = resistivity of the conductor material (in ohm-meters, $\Omega \cdot m$)
- **L** = length of the conductor (in meters, m)
- **A** = cross-sectional area of the conductor (in square meters, m^2)

Example: for 1 km of 2.5 mm² copper conductor (where the the resistivity (ρ) is 1.72 10⁻⁸ (m^2), the resistance R is calculated as follows:

$$(1.72 \cdot 10^{-8}) \times 1000 / (2.5 \cdot 10^{-6} m^2) = 6.88 \text{ ohms}$$

The loss (Watt) is then $R \times I^2$ or $6.88 \text{ ohms} \times 6.6^2 A^2 = 299.69 \text{ W/km}$ or 0.299 W/m .

The loss (Watt) for a secondary cable with 2 conductors is thus $2 \times 0.299 = 0.599$ or 0.6 W/m .

As such we can calculate:

- Secondary cable for a 2.5 mm² Cu-wire (2 conductors): 0.6 W/m
- Secondary cable for a 4 mm² Cu-wire (2 conductors): 0.4 W/m
- Primary cable for a 6 mm² Cu-wire (1 conductor): 0.12 W/m

The cable between the isolation transformer and the lamp adds losses that cannot be ignored when dimensioning the circuits and selecting rating for secondary transformers and regulators.



WARNING

Cable lengths should not exceed 100 meters.

For a secondary cable of e.g., 20 m of 2.5 mm² CU-wire, $20 \text{ m} \times 0.6 \text{ W/m} = 12 \text{ W}$ equals the additional loss to be taken into account.

For a primary cable of e.g., 100 m of 6 mm² CU-wire, $100 \text{ m} \times 0.12 \text{ W/m} = 12 \text{ W}$ equals the additional loss to be taken into account.

Appendix C: Snow Plowing Guidelines

Introduction

ADB SAFEGATE inset light fixtures are engineered with a low protrusion height to minimize the risk of damage during snow plowing, compared to medium or high protrusion alternatives. Select fixtures offer reinforced prisms (see [Reinforced Prisms](#)) or sapphire prisms for increased scratch resistance and extended product lifetime.

Consistent adherence to airport winter operations guidelines is essential to protect in-pavement airfield ground lights from snow plow damage. This manual provides a summary of key airport operator specifications and additional recommendations to help prevent damage to inset lights throughout winter operations.

- FAA AC 150/5200-30D – Airport Winter Safety and Operations
- FAA AC 150/5220-20A – Airport Snow and Ice Control Equipment
- FAA AC 150/5340-26C – Maintenance of Airport Visual Aid Facilities
- FAA EB85 – Ductile Snow Plow Protection Ring and Installation Procedures
- ACRP Report 123 – A Guidebook for Airport Winter Operations

Winter Operation Training

Many airports conduct dry-run winter operations training ahead of the winter season. To maximize safety and efficiency, we recommend performing tests and simulations on designated sections of taxiways or runways that are equipped with the relevant fittings. This proactive approach helps identify potential issues early, minimizing the risk of damage to airfield luminaires and maintenance vehicles during snow plowing.

Preparation

You can take some steps before snow or ice removal to make the process easier:

- **Anti-icing chemicals:** Before precipitation forms, use only approved anti-icing chemicals to prevent strong ice bonds and assist with melting. Ensure pH does not exceed 11.
- **Pre-heating:** Switch on in-pavement lights at maximum intensity 30–40 minutes prior to removal. This helps melt snow and ice and reduces fixture damage.

Snow and Ice Removal Practices

A combination of snow plows, rotary runway brooms, de-icing chemicals and blowers should be used for comprehensive snow and ice removal.

- **Snow plows:**
 - Adjust the blade to maintain a small distance above the pavement surface, minimizing contact with in-pavement lights.
 - Reduce vehicle speed for added protection.

Rotary runway brooms:

- Use rotary brooms to remove residual snow from in-pavement light fixtures for a thorough finish.

De-icing chemicals:

- Use only approved de-icing chemicals to break down the ice structure, lower its freezing point and cause it to melt. Ensure pH does not exceed 11.

For detailed guidance, see [Snow Plows](#), [Rotary Brooms](#) and [De-Icing Chemicals](#).



Note

For frequent snow removal, high-strength steel snow plow rings are recommended to better absorb impact and protect aluminum alloy in-pavement lights. For detailed design and installation information, consult FAA Engineering Brief 85.

Snow Plows

Cutting edge material and structure:

- Equip snow plows with plastic cutting edges made from polyurethane, rubber, or similar materials.
- Regularly check for wear and abrasion marks; replace worn down plastic immediately. Avoid exposure of metal portions.

Figure 71: Well-aligned plastic cutting edge



- Ensure plastic segments are well-aligned and free of vertical or horizontal steps, which increase risk of luminaire damage.

Figure 72: Signs of wear on plastic cutting edge



Cutting edge height:

- Set the plow blade/cutting edge slightly above ground level (10–15 mm clearance) when stationary.

Figure 73: Cutting edge without clearance



- Remaining snow/ice should be removed with rotary brooms or approved chemicals.

- Use casters, shoes, or support wheels to maintain clearance during operation; avoid steel wheels and protruding bolts with less than 20 mm clearance.

Figure 74: Snow plow with support wheels



Snow plow angle and speed:

- Limit plow speed to 40 km/h or less; when crossing over in-pavement fixtures, reduce to below 10 km/h or lift blades.
- Maintain movable segment mechanics; adjust and control plow angles per manufacturer recommendations.
- If frequent prism damage occurs, adjust the snow plow swivel angle to better align with the vehicle's driving line.
- Adapt settings to temperature and snow quantity, following supplier recommendations.

Rotary Brooms

Rotary runway brooms play a vital role in both snow and ice removal, helping to maintain a connected airfield for smarter, data-driven decision making.

- **Snow removal:** Rotary brooms are highly effective at clearing snow from in-pavement light fixtures, often outperforming plow blades in removing the final layers.
- **Ice removal:** The type of broom used is critical. In some cases, brooms may "polish" the ice, which can reduce runway traction. Select broom types carefully for ice removal operations.

Bristle selection and maintenance:

- Bristles are available in steel or poly varieties.
 - **Steel bristles** cut through ice but can accelerate wear and scratching of glass prisms, impacting light photometry.
 - **Poly bristles** are ideal for flipping or wiping away snow with minimal impact on fixtures.
- To reduce wear and damage, avoid using steel bristles when possible, or use a mix of steel and poly bristles (e.g., one-third steel).
- Always check for adequate contact pressure, especially during pre-winter dry-run tests.
- Inspect bristle wear according to manufacturer recommendations and replace brooms as needed. Worn bristles become stiffer and can significantly increase wear on light fixtures, particularly the prisms.
- Avoid using silica or glass sand. If their use is necessary, remove as soon as operational conditions allow and use rotating brushes at low speed.

De-Icing Chemicals

In some cases, chemicals may be necessary to remove compacted snow from in-pavement light fixtures. To protect your airfield equipment, we recommend using these solutions sparingly. Excessive chemical application can increase the risk of damage to both the fixtures and underground electrical components, leading to additional maintenance and costs. For best results, ensure that chemical solutions do not exceed a pH value of 11. This precaution helps safeguard your lighting systems and supports dependable, long-term airside operations/

Ensure pH value does not exceed 11 to safeguard lighting systems and minimize additional maintenance.

ADB SAFEGATE light fixtures are tested to work with common airfield chemicals, including:

- Potassium Acetate
- Potassium Formate
- Sodium Acetate
- Sodium Formate

Reinforced Prisms

Using reinforced prisms, such as "sapphire™" prisms available in the AXON range, can significantly extend maintenance intervals. These prisms are approximately four times harder than standard glass, offering increased durability when steel brushes are required. While not scratch-proof, sapphire prisms can help increase service life and reduce maintenance frequency.

Appendix D: Support

Our experienced engineers are available for support and service at all times, 24 hour/7 days a week. They are part of a dynamic organization making sure the entire ADB SAFEGATE is committed to minimal disturbance for airport operations.

ADB SAFEGATE Support

Technical Support – Global

Customers in Europe, the Middle East, Africa and Asia Pacific are more than welcome to our portal for technical support. Trained in all areas of system issues, troubleshooting, quality control and technical assistance, our highly experienced Technical support specialists are available 24 hours a day, seven days a week to provide assistance over the phone.

Europe: **+32-2-722-17-11**

China: **+86-10-8476-0106**

Middle East and Africa: **+971-4-452-7575**

In the Americas, we also offer live technical support.

Live Technical Support – Americas

If at any time you have a question or concern about your product, contact ADB SAFEGATE's US-based technical support specialists, available 24 hours a day, seven days a week, to assist you via phone.

ADB SAFEGATE Americas Technical Service & Support (US & Canada) :**+1-800-545-4157**

ADB SAFEGATE Americas Technical Service & Support (Canada): **+1-905-631-1597**

ADB SAFEGATE Americas Technical Service & Support (International): **+1-614-861-1304**. For technical service press 3 and for sales support press 4.

We can also be reached via email during regular business hours.

Airfield and Gate: **techservice.us@adbsafegate.com**

Gate: **gateservice.us@adbsafegate.com**

We look forward to working with you!

Before You Call

When you have an airfield lighting or control system problem, prior to calling, please ensure the following:

- Review the product's manual and troubleshooting guide.
- Be located with the product ready to troubleshoot.
- Have all necessary information available: airport code/company name, customer id number, contact phone number/email address, product/part number.
- Have all necessary tools that may be needed at hand.

When calling about an issue with Safedock A-VDGS, we can serve you better if you collect the following information before you call:

- Relevant information regarding the issue you are calling about, such as gate number, flight number, aircraft type and time of the event.
- What, if any, actions have been taken to resolve the issue prior to the call.
- If available, provide a CCTV recording of the incident to aid in aligning the information from the Safedock log file.

For more information, see www.adbsafegate.com, contact ADB SAFEGATE Support via email at **support@adbsafegate.com**.

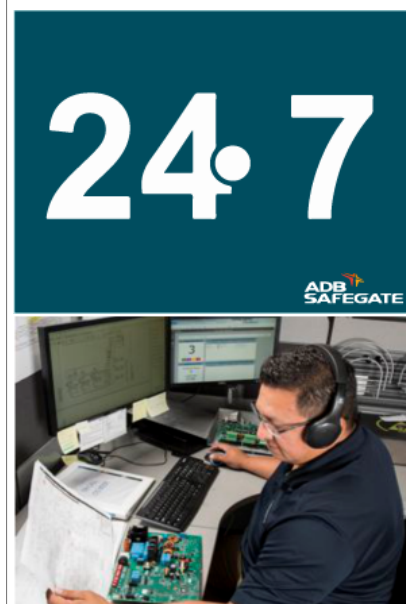

D.1 ADB SAFEGATE Website

The ADB SAFEGATE website, www.adbsafegate.com, offers information regarding our airport solutions, products, company, news, links, downloads, references, contacts and more.

D.2 Recycling

D.2.1 Local Authority Recycling

The disposal of ADB SAFEGATE products is to be made at an applicable collection point for the recycling of electrical and electronic equipment. The correct disposal of equipment prevents any potential negative consequences for the environment and human health, which could otherwise be caused by inappropriate waste handling. The recycling of materials helps to conserve natural resources. For more detailed information about recycling of products, contact your local authority city office.

D.2.2 ADB SAFEGATE Recycling

ADB SAFEGATE is fully committed to environmentally-conscious manufacturing with strict monitoring of our own processes as well as supplier components and sub-contractor operations. ADB SAFEGATE offers a recycling program for our products to all customers worldwide, whether or not the products were sold within the European Union (EU).

ADB SAFEGATE products and/or specific electrical and electronic component parts which are fully removed/separated from any customer equipment and returned will be accepted for our recycling program.

All items returned must be clearly labeled as follows:

- For Restriction of Hazardous Substances (*RoHS*)/Waste Electrical and Electronic Equipment (*WEEE*) Recycling
- Sender contact information (Name, Business Address, Phone number).
- Main Unit Serial Number.

ADB SAFEGATE will continue to monitor and update according for any future requirements for *EU directives* as and when *EU member states* implement new *regulations* and or *amendments*. It is our aim to maintain our *compliance plan* and assist our customers.

Company Addresses

ADB SAFEGATE, Belgium	ADB SAFEGATE BV Leuvensesteenweg 585 B-1930 Zaventem Belgium
Contact:	
Tel.: +32 2 722 17 11	Email: marketing@adbsafegate.com
Fax: +32 2 722 17 64	Internet: www.adbsafegate.com
ADB SAFEGATE, Americas	ADB SAFEGATE Americas, LLC 700 Science Blvd Gahanna, OH 43230 USA
Contact:	
Tel.: +1 (614) 861 1304	Email: sales.us@adbsafegate.com
Fax: +1 (614) 864 2069	Internet: www.adbsafegate.com
ADB SAFEGATE, Sweden	ADB SAFEGATE Sweden AB Djurhagegatan 19 SE-213 76 Malmö Sweden
Contact:	
Tel.: +46 (0)40 699 17 00	Email: marketing@adbsafegate.com
Fax: +46 (0)40 699 17 30	Internet: www.adbsafegate.com
ADB SAFEGATE, China	ADB SAFEGATE Airfield Technologies Ltd. China Unit 603, D Block, CAMIC International Convention Center, No 3, Hua Jia Di East road, ChaoYang district, Beijing 100102 P.R. China
Contact:	
Tel.: +86 (10) 8476 0106	Email: china@safegate.com
Fax: +86 (10) 8476 0090	Internet: www.adbsafegate.com
ADB SAFEGATE, Germany	ADB SAFEGATE Germany GmbH Konrad-Zuse-Ring 6, D-68163 Mannheim Germany
Contact:	
Tel.: +49 (621) 87 55 76-0	Email: marketing@adbsafegate.com
Fax: +49 (621) 87 55 76-55	Internet: www.adbsafegate.com

WWW.ADBSAFEGATE.COM

Empowering the Airside **Evolution**

SMARTER. BETTER. **NOW.**



Copyright ©2016—2026 ADB SAFEGATE, All Rights Reserved