



CRT - Thyristor Constant Current Regulator
L-828/L-829, 4-30kW, 6.6A, with RELIANCE Power ACE3

User Manual

DM00007-000-00, Rev. C, 2023/04/28



A.0 Disclaimer / Standard Warranty

CE certification

The equipment listed as CE certified means that the product complies with the essential requirements concerning safety and hygiene. The European directives that have been taken into consideration in the design are available on written request to ADB SAFEGATE.

ETL certification

The equipment listed as ETL certified means that the product complies with the essential requirements concerning safety and FAA Airfield regulations. The FAA directives that have been taken into consideration in the design are available on written request to ADB SAFEGATE.

All Products Guarantee

ADB SAFEGATE will correct by repair or replacement per the applicable guarantee below, at its option, equipment or parts which fail because of mechanical, electrical or physical defects, provided that the goods have been properly handled and stored prior to installation, properly installed and properly operated after installation, and provided further that Buyer gives ADB SAFEGATE written notice of such defects after delivery of the goods to Buyer. Refer to the Safety section for more information on Material Handling Precautions and Storage precautions that must be followed.

ADB SAFEGATE reserves the right to examine goods upon which a claim is made. Said goods must be presented in the same condition as when the defect therein was discovered. ADB SAFEGATE further reserves the right to require the return of such goods to establish any claim.

ADB SAFEGATE's obligation under this guarantee is limited to making repair or replacement within a reasonable time after receipt of such written notice and does not include any other costs such as the cost of removal of defective part, installation of repaired product, labor or consequential damages of any kind, the exclusive remedy being to require such new parts to be furnished.

ADB SAFEGATE's liability under no circumstances will exceed the contract price of goods claimed to be defective. Any returns under this guarantee are to be on a transportation charges prepaid basis. For products not manufactured by, but sold by ADB SAFEGATE, warranty is limited to that extended by the original manufacturer. This is ADB SAFEGATE's sole guarantee and warranty with respect to the goods; there are no express warranties or warranties of fitness for any particular purpose or any implied warranties of fitness for any particular purpose or any implied warranties other than those made expressly herein. All such warranties being expressly disclaimed.

Standard Products Guarantee

Products manufactured by ADB SAFEGATE are guaranteed against mechanical, electrical, and physical defects (excluding lamps) which may occur during proper and normal use for a period of two years from the date of ex-works delivery, and are guaranteed to be merchantable and fit for the ordinary purposes for which such products are made.



Note

See your applicable sales agreement for a complete warranty description.

Replaced or repaired equipment under warranty falls into the warranty of the original delivery. No new warranty period is started for these replaced or repaired products.

FAA Certified products manufactured by ADB SAFEGATE

ADB SAFEGATE L858 Airfield Guidance Signs are warranted against mechanical and physical defects in design or manufacture for a period of 2 years from date of installation, per FAA AC 150/5345-44 (applicable edition).

ADB SAFEGATE LED products (with the exception of obstruction lighting) are warranted against electrical defects in design or manufacture of the LED or LED specific circuitry for a period of 4 years from date of installation, per FAA EB67 (applicable edition). These FAA certified constant current (series) powered LED products must be installed, interfaced and powered with and through products certified under the FAA Airfield Lighting Equipment Program (ALECP) to be included in this 4 (four) year warranty. This includes, but is not limited to, interface with products such as Base Cans, Isolation Transformers, Connectors, Wiring, and Constant Current Regulators.



Note

See your sales order contract for a complete warranty description.

Replaced or repaired equipment under warranty falls into the warranty of the original delivery. No new warranty period is started for these replaced or repaired products.

Liability



WARNING

Use of the equipment in ways other than described in the catalog leaflet and the manual may result in personal injury, death, or property and equipment damage. Use this equipment only as described in the manual.

ADB SAFEGATE cannot be held responsible for injuries or damages resulting from non-standard, unintended uses of its equipment. The equipment is designed and intended only for the purpose described in the manual. Uses not described in the manual are considered unintended uses and may result in serious personal injury, death or property damage.

Unintended uses, includes the following actions:

- Making changes to equipment that have not been recommended or described in this manual or using parts that are not genuine ADB SAFEGATE replacement parts or accessories.
- Failing to make sure that auxiliary equipment complies with approval agency requirements, local codes, and all applicable safety standards if not in contradiction with the general rules.
- Using materials or auxiliary equipment that are inappropriate or incompatible with your ADB SAFEGATE equipment.
- Allowing unskilled personnel to perform any task on or with the equipment.

Copyright Statement

This manual or parts thereof may not be reproduced, stored in a retrieval system, or transmitted, in any form or by any means, electronic, mechanical, photocopying, recording, nor otherwise, without the author's prior written consent.

This manual could contain technical inaccuracies or typographical errors. The author reserves the right to revise this manual from time to time in the contents thereof without obligation of the author to notify any person of such revision or change. Details and values given in this manual are average values and have been compiled with care. They are not binding, however, and the author disclaims any liability for damages or detriments suffered as a result of reliance on the information given herein or the use of products, processes or equipment to which this manual refers. No warranty is made that the use of the information or of the products, processes or equipment to which this manual refers will not infringe any third party's patents or rights. The information given does not release the buyer from making their own experiments and tests.

TABLE OF CONTENTS

1.0 Safety	1
1.1 Safety Messages	1
1.1.1 Introduction to Safety	2
1.1.2 Intended Use	2
1.1.3 Material Handling Precautions: Storage	3
1.1.4 Material Handling: Heavy Equipment	3
1.1.5 Operation Safety	3
1.1.6 Maintenance Safety	4
1.1.7 Material Handling Precautions, ESD	4
1.1.8 Arc Flash and Electric Shock Hazard	5
2.0 Introduction	7
2.1 About this manual	7
2.1.1 How to work with the manual	7
2.2 CRT Introduction	7
2.3 Constant Current Regulator	8
2.3.1 Total Harmonic Distortion ¹ (THD)	9
2.4 Power Circuit	9
2.4.1 Output Measurement	9
2.5 CCR Control PCB	10
2.5.1 URC4 CCR Controller	10
2.6 L-828/L-829 CCR Monitoring Options	11
2.6.1 Optional Insulation Resistance Monitoring System	11
2.7 Optional Series Cutout Type SCO	12
2.8 Optional Current Clamp Test Point	12
2.9 Local Control Position Detection	12
2.10 Contactor Drive	12
2.11 Remote Control Position Detection	12
2.12 Fault Protection	12
2.13 L-828 CCR	13
2.14 L-829 CCR	14
2.15 L-828 CCRs (4-30 kW 6.6 A): Required Equipment	14
2.16 Input Wire Size	15
2.17 Input Power Breaker Sizing	15
2.18 Specifications	16
2.18.1 Efficiency	16
2.18.2 Reactive Loading	16
2.18.3 Resistive Loading	17
2.18.4 Regulation	17
2.18.5 Environmental Operating Conditions	17
2.18.6 Protection Devices	17
2.18.7 Open-Circuit Protection	17
2.18.8 Input Voltage	18
2.18.9 Temperature Rise	18
3.0 Installation Overview	19
3.1 Intended Use	19
3.2 Unpacking	19
3.3 Material Handling: Heavy Equipment	19
3.4 Installation Overview	20
3.4.1 Wiring Connections and Startup	20
3.5 Stacking Information	22
4.0 CCR Operation	23
4.1 Operation Safety	23
4.2 CCR Control Procedures	23

4.2.1 Local Control	24
4.2.2 Remote Control	25
4.2.3 CCR Shutdown Procedure	25
4.3 CCR Adjustment Procedures	26
4.3.1 Adjusting Output Current (no ACE3)	27
4.3.2 Adjusting Overcurrent Control Board (44A6546)	27
4.3.3 Reducing CCR Power Consumption	28
4.4 SCO Operation	30
5.0 Graphics User Interface (GUI)	33
5.1 Menu Screen	37
5.1.1 Alarms View	38
5.1.2 Events View	38
5.1.3 Status Menu – Hours/Cycle Count	39
5.1.4 Status Menu – Waveform	39
5.1.5 Status Menu – Miscellaneous	40
5.1.6 CCR Menu - Configuration	40
5.1.7 CCR Menu – Measurement Calibration	45
5.1.8 CCR Menu – VA Calibration	45
5.1.9 CCR Menu – IRMS Configuration	47
5.1.10 CCR Menu – Lamps Out Calibration	49
5.1.11 ACE Menu - Configuration	51
5.1.12 ACE Menu – Failsafe	52
5.1.13 ACE Menu – Feature Enable	53
5.1.14 ACE Menu – About	54
6.0 CCR Maintenance	57
6.1 Maintenance Safety	57
6.2 Maintenance Schedule	57
6.2.1 Short-Circuit Test	58
6.2.2 Open-Circuit Test	58
6.3 DA00019-THY-01 Schematics	59
7.0 Troubleshooting	63
7.1 Introduction	63
7.2 Preliminary Troubleshooting	63
7.3 Troubleshooting Failed Components	64
7.3.1 L-828 General Troubleshooting	64
7.4 Additional L-829 General Troubleshooting Procedures	65
7.5 Component Replacement Procedures	65
7.5.1 Removing and Replacing URC4 Regulator Control PCB	66
7.5.2 CCR Contactor Replacement	69
7.5.3 Removing and Replacing Input Lightning Arrestors (front of Component Mounting Plate)	71
7.5.4 Removing and Replacing Output Lightning Arrestors	72
8.0 CRT Parts	75
8.1 CRT Kits	75
8.2 Spare Parts	76
8.3 Assembly Parts	77
9.0 SUPPORT	79
9.1 ADB SAFEGATE Website	79
9.2 Recycling	79
9.2.1 Local Authority Recycling	79
9.2.2 ADB SAFEGATE Recycling	80

List of Figures

Figure 1: L-828 CCR Power Circuit Block Diagram	10
Figure 2: URC4 CCR Controller	10
Figure 3: ACE3 Control Board	11
Figure 4: Current Meter Display	13
Figure 5: L-829 CCR with ACE	14
Figure 6: Wiring on Right Side of the CCR	21
Figure 7: L-828/L-829 Switches	24
Figure 8: Output Current Clamp	26
Figure 9: Regulator URC4 Control PCB	27
Figure 10: CCR Transformer Taps	29
Figure 11: Output Current Gauge	35
Figure 12: Output View and Diagram View	35
Figure 13: IO Card Cage View	36
Figure 14: Regulator Interface Card View	36
Figure 15: Regulator Interface Card View (4x4 Card)	36
Figure 16: Alarms and Warnings Screen (Alarms View)	38
Figure 17: Alarms and Warnings Screen (Events View)	38
Figure 18: Hour/Cycle Count Screen	39
Figure 19: Wave Form Screen	39
Figure 20: Status Menu – Miscellaneous	40
Figure 21: Status Menu – Miscellaneous	40
Figure 22: CCR Configuration Screen 1	41
Figure 23: CCR Configuration Screen 1 for 20A CCRs	42
Figure 24: CCR Configuration Screen 2	42
Figure 25: Current Set Point	42
Figure 26: Current Set Point for 20A CCRs	43
Figure 27: I/O CCR Alarm	43
Figure 28: CSS Loops	44
Figure 29: Calibration Screen	45
Figure 30: Calibration Screen Override	45
Figure 31: Calibration Screen with the red X shown	45
Figure 32: ACE Info Config Screen (network Config)	52
Figure 33: Failsafe Config Screen	52
Figure 34: About Screen	54
Figure 35: About Screen Menu	54
Figure 36: About Screen Disclaimer	55

Figure 37: DA00019-THY-01 Schematic	59
Figure 38: DA00019-THY-01 Schematic T4 Connections	60
Figure 39: DA00019-THY-01 Schematic T1 Voltages	60
Figure 40: DA00019-THY-01 Schematic SCR Connections	61
Figure 41: DA00019-THY-01 Schematic PCB Layout	61
Figure 42: DA00019-THY-01 Schematic Details	62
Figure 43: PCB URC4 Regulator Control (44A7693)	66
Figure 44: Switch Bank 1	67
Figure 45: Switch Bank 2	68
Figure 46: Switch Bank 3	69
Figure 47: Mounting Adapter 63A1153	70
Figure 48: Mounting Adapter 63A1153 Location	71
Figure 49: 94A0576 Type Output Lightning Arrestors	72
Figure 50: Output Lightning Arrestors	73
Figure 51: Component Assembly AS00037-XXXXXXX-01 Parts (front)	77
Figure 52: Component Assembly AS00037-XXXXXXX-01 Parts (back)	77

List of Tables

Table 1: Required Equipment Supplied	14
Table 2: Required Equipment Not Supplied	14
Table 3: Recommended Input Wiring Rating	15
Table 4: CCR Input Voltage and Current for the CCR Power Ratings	15
Table 5: Class, Style and Power Ratings	16
Table 6: Power Factor	16
Table 7: Efficiency	16
Table 8: Output Current and Limits	16
Table 9: Environmental Operating Conditions	17
Table 10: Remote Control Connections (3-Step/6.6 A)	21
Table 11: Remote Control Connections (5-Step/6.6 A)	22
Table 12: Input/Output Connections	22
Table 13: Output Current from Rotary Switch (3-Step/6.6 A)	24
Table 14: Output Current from Rotary Switch (5-Step/6.6 A)	24
Table 15: Remote Control	25
Table 16: Cutout Working Positions	31
Table 17: L-828/L-829 CCR (4-30 kW) Maintenance	57
Table 18: General Troubleshooting	64
Table 19: F3-F4 Fuses	78
Table 20: F1-F2 Fuses	78
Table 21: Contactors K2	78

1.0 Safety

Introduction to Safety

This section contains general safety instructions for installing and using ADB SAFEGATE equipment. Some safety instructions may not apply to the equipment in this manual. Task- and equipment-specific warnings are included in other sections of this manual where appropriate.

1.1 Safety Messages

HAZARD Icons used in the manual

For all HAZARD symbols in use, see the Safety section. All symbols must comply with ISO and ANSI standards.

Carefully read and observe all safety instructions in this manual, which alert you to safety hazards and conditions that may result in personal injury, death or property and equipment damage and are accompanied by the symbol shown below.



WARNING

Failure to observe a warning may result in personal injury, death or equipment damage.



DANGER - Risk of electrical shock or ARC FLASH

Disconnect equipment from line voltage. Failure to observe this warning may result in personal injury, death, or equipment damage. ARC Flash may cause blindness, severe burns or death.



WARNING - Wear personal protective equipment

Failure to observe may result in serious injury.



WARNING - Do not touch

Failure to observe this warning may result in personal injury, death, or equipment damage.



CAUTION

Failure to observe a caution may result in equipment damage.



ELECTROSTATIC SENSITIVE DEVICES

This equipment may contain electrostatic devices.

Qualified Personnel



Important Information

The term **qualified personnel** is defined here as individuals who thoroughly understand the equipment and its safe operation, maintenance and repair. Qualified personnel are physically capable of performing the required tasks, familiar with all relevant safety rules and regulations and have been trained to safely install, operate, maintain and repair the equipment. It is the responsibility of the company operating this equipment to ensure that its personnel meet these requirements.

Always use required personal protective equipment (PPE) and follow safe electrical work practice.

1.1.1 Introduction to Safety

CAUTION

Unsafe Equipment Use

This equipment may contain electrostatic devices, hazardous voltages and sharp edges on components

- Read installation instructions in their entirety before starting installation.
- Become familiar with the general safety instructions in this section of the manual before installing, operating, maintaining or repairing this equipment.
- Read and carefully follow the instructions throughout this manual for performing specific tasks and working with specific equipment.
- Make this manual available to personnel installing, operating, maintaining or repairing this equipment.
- Follow all applicable safety procedures required by your company, industry standards and government or other regulatory agencies.
- Install all electrical connections to local code.
- Use only electrical wire of sufficient gauge and insulation to handle the rated current demand. All wiring must meet local codes.
- Route electrical wiring along a protected path. Make sure they will not be damaged by moving equipment.
- Protect components from damage, wear, and harsh environment conditions.
- Allow ample room for maintenance, panel accessibility, and cover removal.
- Protect equipment with safety devices as specified by applicable safety regulations
- If safety devices must be removed for installation, install them immediately after the work is completed and check them for proper functioning prior to returning power to the circuit.



Failure to follow this instruction can result in serious injury or equipment damage

Additional Reference Materials



Important Information

- IEC - International Standards and Conformity Assessment for all electrical, electronic and related technologies.
- IEC 60364 - Electrical Installations in Buildings.
- FAA Advisory: AC 150/5340-26 (current edition), Maintenance of Airport Visual Aid Facilities.
- Maintenance personnel must refer to the maintenance procedure described in the ICAO Airport Services Manual, Part 9.
- ANSI/NFPA 79, Electrical Standards for Metalworking Machine Tools.
- National and local electrical codes and standards.

1.1.2 Intended Use



CAUTION

Use this equipment as intended by the manufacturer

This equipment is designed to perform a specific function, do not use this equipment for other purposes

- Using this equipment in ways other than described in this manual may result in personal injury, death or property and equipment damage. Use this equipment only as described in this manual.

Failure to follow this instruction can result in serious injury or equipment damage

1.1.3 Material Handling Precautions: Storage



CAUTION

Improper Storage

Store this equipment properly

- If equipment is to be stored prior to installation, it must be protected from the weather and kept free of condensation and dust.

Failure to follow this instruction can result in equipment damage

1.1.4 Material Handling: Heavy Equipment



DANGER

Unstable load

Use caution when moving heavy equipment

- Use extreme care when moving heavy equipment.
- Verify that the moving equipment is rated to handle the weight.
- When removing equipment from a shipping pallet, carefully balance and secure it using a safety strap.

Failure to follow this instruction can result in death, serious injury, or equipment damage

1.1.5 Operation Safety



CAUTION

Improper Operation

Do Not Operate this equipment other than as specified by the manufacturer

- Only qualified personnel, physically capable of operating the equipment and with no impairments in their judgment or reaction times, should operate this equipment.
- Read all system component manuals before operating this equipment. A thorough understanding of system components and their operation will help you operate the system safely and efficiently.
- Before starting this equipment, check all safety interlocks, fire-detection systems, and protective devices such as panels and covers. Make sure all devices are fully functional. Do not operate the system if these devices are not working properly. Do not deactivate or bypass automatic safety interlocks or locked-out electrical disconnects or pneumatic valves.
- Protect equipment with safety devices as specified by applicable safety regulations.
- If safety devices must be removed for installation, install them immediately after the work is completed and check them for proper functioning.
- Route electrical wiring along a protected path. Make sure they will not be damaged by moving equipment.
- Never operate equipment with a known malfunction.
- Do not attempt to operate or service electrical equipment if standing water is present.
- Use this equipment only in the environments for which it is rated. Do not operate this equipment in humid, flammable, or explosive environments unless it has been rated for safe operation in these environments.
- Never touch exposed electrical connections on equipment while the power is ON.

Failure to follow these instructions can result in equipment damage

1.1.6 Maintenance Safety

DANGER

Electric Shock Hazard

This equipment may contain electrostatic devices

- Do not operate a system that contains malfunctioning components. If a component malfunctions, turn the system OFF immediately.
- Disconnect and lock out electrical power.
- Allow only qualified personnel to make repairs. Repair or replace the malfunctioning component according to instructions provided in its manual.
-



Failure to follow these instructions can result in death or equipment damage

1.1.7 Material Handling Precautions, ESD



CAUTION

Electrostatic Sensitive Devices

This equipment may contain electrostatic devices

- Protect from electrostatic discharge.
- Electronic modules and components should be touched only when this is unavoidable e.g. soldering, replacement.
- Before touching any component of the cabinet you shall bring your body to the same potential as the cabinet by touching a conductive earthed part of the cabinet.
- Electronic modules or components must not be brought in contact with highly insulating materials such as plastic sheets, synthetic fiber clothing. They must be laid down on conductive surfaces.
- The tip of the soldering iron must be grounded.
- Electronic modules and components must be stored and transported in conductive packing.

Failure to follow this instruction can result in equipment damage

1.1.8 Arc Flash and Electric Shock Hazard



DANGER

Series Circuits have Hazardous Voltages

This equipment produces high voltages to maintain the specified current - Do NOT Disconnect while energized.

- Allow only qualified personnel to perform maintenance, troubleshooting, and repair tasks.
- Only persons who are properly trained and familiar with ADB SAFEGATE equipment are permitted to service this equipment.
- An open airfield current circuit is capable of generating >5000 Vac and may appear OFF to a meter.
- Never unplug a device from a constant current circuit while it is operating; Arc flash may result.
- Disconnect and lock out electrical power.
- Always use safety devices when working on this equipment.
- Follow the recommended maintenance procedures in the product manuals.
- Do not service or adjust any equipment unless another person trained in first aid and CPR is present.
- Connect all disconnected equipment ground cables and wires after servicing equipment. Ground all conductive equipment.
- Use only approved ADB SAFEGATE replacement parts. Using unapproved parts or making unapproved modifications to equipment may void agency approvals and create safety hazards.
- Check the interlock systems periodically to ensure their effectiveness.
- Do not attempt to service electrical equipment if standing water is present. Use caution when servicing electrical equipment in a high-humidity environment.
- Use tools with insulated handles when working with airfield electrical equipment.

Failure to follow these instructions can result in death or equipment damage

2.0 Introduction

Thyristor L-828 / L-829 Constant Current Regulator

2.1 About this manual

The manual shows the information necessary to:

- Install the CCR
- Carry Out Maintenance
- Carry Out Troubleshooting

2.1.1 How to work with the manual

1. Familiarize yourself with the structure and content.
2. Carry out the actions completely and in the given sequence.

2.2 CRT Introduction



WARNING

Read the instructions in their entirety before starting installation.

This section describes the ADB Safegate Thyristor Controlled L-828/L-829, constant current regulators (CCRs). These CCRs are manufactured to meet FAA Advisory Circular 150/5345-10 (latest edition).



2.3 Constant Current Regulator

Compliance with Standards

FAA: L-828/L-829 AC 150/5345-10 (Current Edition).
ETL Certified.

Uses

FAA L-828/L-829 Supplies three or five precision output levels to power series lighting circuits on airport runways and taxiways.

Theory of Operation

Solid-state control and monitoring feedback circuitry is used for output current regulation of ± 0.1 A over an input voltage variation of -5% to +10% of nominal. If the load on the regulator varies, a gating signal controlled by feedback circuitry changes the control circuit conduction angle in order to control the power to the main transformer. This maintains the transformer's output current at the preset brightness level.

RELIANCE Power ACE3 Unit

The optional RELIANCE Power ACE3 unit provides L-829 monitoring and optional Insulation Resistance and CCR Input Monitoring capability.

- CCR output, current, voltage, VA, watts
- CCR input voltage
- CCR run-time by step
- CCR cycle count

Optional CCR input monitoring adds the following parameters:

- CCR input current
- CCR input volt-amps (VA)
- CCR input power (watts)
- CCR input power factor
- CCR % efficiency

The RELIANCE Power ACE3 unit is also a component of ADB SAFEGATE's distributed control and monitoring system. Each unit can be easily connected to an Airport Lighting Control & Monitoring System (ALCMS) by simply adding redundant communication wires. More information can be found on the RELIANCE Power ACE3 data sheet 3097.

Application

The CRT thyristor type CCR should not be used to power an L-849 REIL system using xenon flash lamps unless the CCR is at least half loaded with steady burning lights. The CRT-Type CCR should not be used to power Runway Guard Lights using incandescent (tungsten-halogen) lamps regardless of load. Do not route output cable in the vicinity of other wiring sensitive to electromagnetic interference or radio frequency interference. See RELIANCE Power CRF ferroresonant regulator data sheet 4024 for these applications.

Environmental Operating Conditions

Temperature:	L-828: -40°C to +55°C (-40°F to +131°F) L-829: 0°C to +55°C (+32°F to +131°F)
--------------	--

Humidity:	10 to 95%
-----------	-----------

Altitude:	0 to 6,600 ft (2,000 m)
-----------	-------------------------

Power Supply

Power Input:	60 Hz, 1 P, 208 - 480 VAC (-5/+10%) 50 Hz, 1 P, 208 - 400 VAC (-5/+10%)
Power Factor:	0.90 minimum for 4 - 10 kW* 0.95 minimum for 15 - 30 kW*
Efficiency:	90% minimum for 4 - 25 kW* 92% minimum for 30 kW*
Remote Control (internally sourced):	120 VAC 50/60 Hz (-5/+10%) +48 VDC ($\pm 10\%$) +24 VDC ($\pm 10\%$)

* At top step with full resistive load.

Weights and Dimensions

CCR Size	Dimensions in (mm) (H x W x D)	CCR Weight lb (kg)	Shipping Weight lb (kg)
4 - 30 kW	40 x 24 x 26 (1016 x 610 x 660)	4 kW: 215 (91.5)	4 kW: 255 (115.7)
		7.5 kW: 265 (120.2)	7.5 kW: 305 (138.3)
		10 kW: 302 (137)	10 kW: 342 (155.1)
		15 kW: 470 (213.5)	15 kW: 510 (231.3)
		20 kW: 553 (250.8)	20 kW: 593 (269)
		30 kW: 705 (320)	30 kW: 745 (338)

Additional Options

Additional options are available to customize CCRs for specific application requirements.

- Output Current Sensing Relay Option: provides a dedicated dry contact closure if CCR output current is present
- Door Documentation Pocket Option: provides a pocket for CCR documentation on the inside of the front door
- Input Circuit Breaker Option: replaces the standard input power fuses with an internally mounted thermal circuit breaker

Not all Additional Options are shown in the ordering code. Please contact ADB SAFEGATE Sales for further information.

2.3.1 Total Harmonic Distortion¹ (THD)

Current THD: 10% maximum in highest step

Voltage THD: 1.9% maximum in all steps

2.4 Power Circuit

See [Figure 1](#). Constant voltage input lines are fed through an SCR to a power transformer (T1). The output of T1 feeds a field circuit with a constant current level set by switch 1 or by remote signals from TB1. The URC PCB monitors the field current through a high voltage current transformer (T2) and regulates the field current by switching the SCR on and off as needed to maintain the desired current.

2.4.1 Output Measurement

The output current flows through the current transformer, T2, which provides feedback to the URC PCB board on the actual current output to the airfield series circuit and to a true-rms-reading ammeter mounted onto the front panel to indicate output current.

¹ ¹ Tested with 100% resistive load according to FAA AC150/5345-10 (Latest Edition).

2.5 CCR Control PCB

See in the schematics section: [Figure 37](#).

This subsection describes the board level circuitry found on the URC PCB.

Figure 1: L-828 CCR Power Circuit Block Diagram

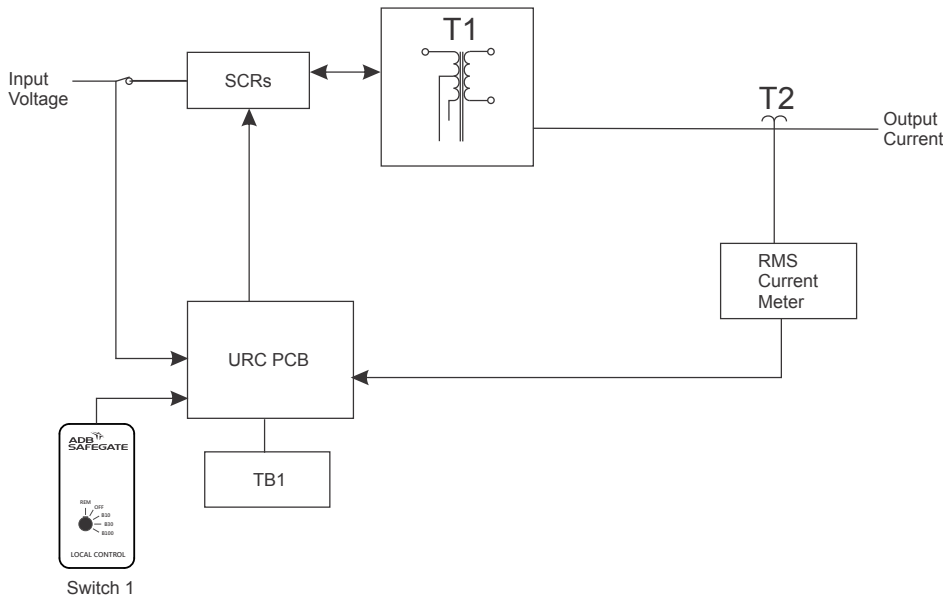

2.5.1 URC4 CCR Controller

The URC4 CCR Controller is an advanced PC board that is designed to provide all regulator and control, monitoring and interface functions to the ACE3™. This is accomplished with a microcontroller and interface circuitry contained on a single 4 x 8 inch (102 mm x 203 mm) through-hole type printed circuit board. The regulator controller PCB performs the functions listed below..

- Produces SCR drive signals in accordance with the desired output current setting.
- Detects an over-current, or open circuit, and switches the constant current regulator off.
- When in Remote mode, enables the CCI to provide 120 Vac at 50 W. The CCI is the Remote power control source.
- Provides direct, real time communication to the ACE3 control and monitoring unit via proprietary protocol

Figure 2: URC4 CCR Controller

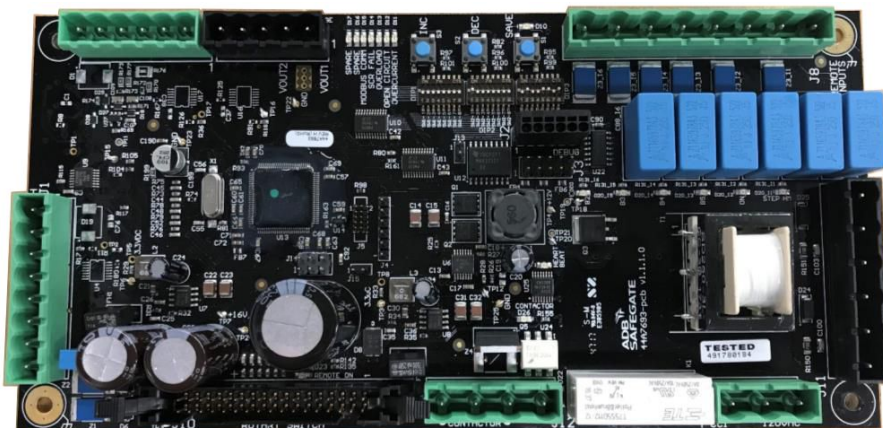

2.5.1.1 L-829 Advanced Control Equipment

The L-829 ACE3™ control and monitoring unit consists of an integrated control unit that is interfaced to each CCR either internally or within a small external enclosure. The ACE3 printed circuit boards are mounted inside an environmental enclosure that is directly attached to the door of the L-829 CCR.

Figure 3: ACE3 Control Board

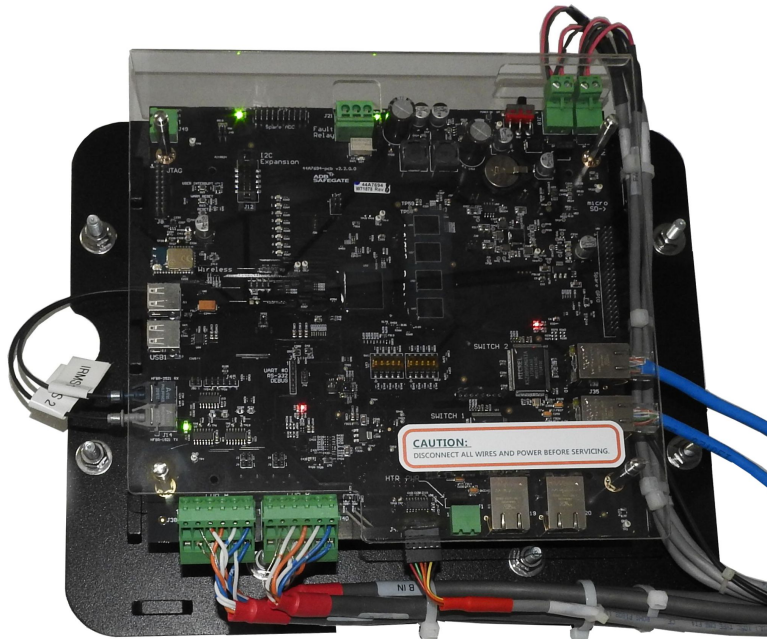

For more information see www.adbsafegate.com

2.6 L-828/L-829 CCR Monitoring Options

The L-829 CCR monitoring options include the Insulation Resistance Monitoring System (IRMS), Lamps out Monitoring for non- LED type airfield circuits and ALCMS Computer or PLC Interface.

2.6.1 Optional Insulation Resistance Monitoring System



CAUTION

When servicing a regulator with an IRMS module, be sure that power to the IRMS is disconnected before touching the IRMS board or any of the high voltage components or wires.

The IRMS is used only on the L-829. It performs scheduled cable insulation resistance measurements and can also perform manually requested measurements. IRMS provides the ability for monitoring the long-term degradation of the airfield series circuit cabling and showing the results on the L-829 CCR front display panel. Utilizing the ACE3 display, all features of the Megging option, from alarm thresholds to Meg on demand can be performed.

2.7 Optional Series Cutout Type SCO

The series cutout Type SCO is often used at airports having a large number of series circuits to isolate the series circuit from the CCR during maintenance or testing operations. It also allows manual measurement of resistance of the series circuit to ground without disconnecting the series cable. The SCO cutout has a nominal working voltage of 5 kV and a nominal carrying current capacity of 20 amps AC.



Note

For more information refer to the SCO Cutout manual 96A0294.

2.8 Optional Current Clamp Test Point

Regulators without an optional Series Circuit Cutout (SCO) will have a current clamp test point installed to provide a location to attach an output current clamp when used to calibrate the output of the CCR.

2.9 Local Control Position Detection

Local control position detection is accomplished by using a rotary switch mounted on the front door of the CCR. See [Figure 2](#).

2.10 Contactor Drive

The contactor drive circuit on the CCR Control PCB pulls in the main contactor K2 by shorting points J3-7 to J3-8.

2.11 Remote Control Position Detection

When the local control signal to the micro-controller indicates "remote" the remote control circuitry is active, providing 120VAC to the CCI connection on TB1. The remote control inputs incorporate surge suppression and are optically isolated from the rest of the PCB.

2.12 Fault Protection

This subsection describes CCR fault protection.

Overcurrent Protection

The micro-controller detects an over current condition by comparing the output current to a preset value. If the output current exceeds this value the controller will shut the regulator down by removing drive to the input contactor. This contactor will remain de-energized until the controller is reset either by selecting the OFF position (remotely or locally) or cycling the input power off for a minimum of 2 seconds and then back on. The control board will not recognize momentary over currents caused by load switching or other transient conditions.

Open Circuit Protection

The micro-controller detects an open circuit by the absence of current in the regulator output (this will also detect an open or shorted current transformer). If the output current is less than 1.5 amps, the controller will shut the current regulator down within one second by removing drive to the input contactor. This contactor will remain de-energized until the controller is reset either by selecting the OFF position (remotely or locally) or cycling the input power off for a minimum of 2 seconds and then back on.

2.13 L-828 CCR

See [Figure 2](#). This subsection describes the L-828 CCR. The L-828 uses a CCR Control PCB to provide regulator and control functions.



Note

[Figure 2](#) shows the display of a 15 kW 6.6 A L-828 Thyristor Controlled CCR.

Figure 4: Current Meter Display

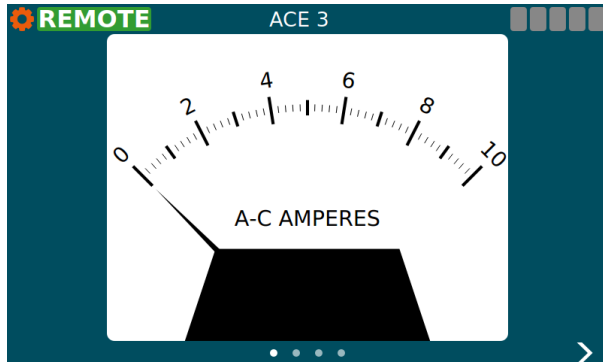

The L-828 CCRs are designed to:

- Supply three or five precision output current levels (6.6 A maximum) to power airport series lighting circuits on runways and taxiways.
- Accurately regulate the output current to within $\pm 1\%$ of the adjustable nominal levels from no load to full load and with input voltage variations of -5% to $+10\%$ of nominal.
- Maintain the nominal output current levels even when 30 percent of the isolation transformers in the series lighting circuit supplied by the regulator have open secondaries.

2.14 L-829 CCR

See [Figure 3](#). This subsection describes the L-829 CCR. The L-829 uses a CCR Control PCB to provide regulator and control functions. It also uses the Advanced Control Equipment (ACE™ or ACE3™) for control and monitoring functions.

Note

[Figure 3](#) shows a L-829 (15 kW/6.6 A) CCR. The other L-829 CCRs (4, 7.5, 10, 20-30 kW/6.6 A) may differ in size and appearance.

Figure 5: L-829 CCR with ACE

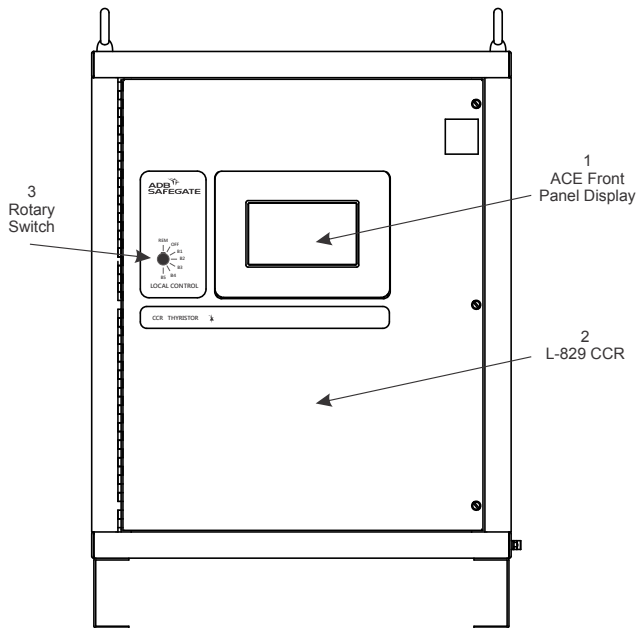

2.15 L-828 CCRs (4-30 kW 6.6 A): Required Equipment

Refer to [Table 1](#) for required equipment that is supplied.

Refer to [Table 2](#) for required equipment that is not supplied.

Table 1: Required Equipment Supplied

Description	Quantity
L-828/L-829 constant current regulator	As Req'd on Order
Instruction manual	1 per CCR on Order

Table 2: Required Equipment Not Supplied

Description	Quantity
Input power wire. Refer to Input Wire Size .	As required
Remote control wire, AWG 18 minimum, AWG 14 maximum	As required
Ground wire, AWG 8 minimum (6.6 A); AWG 6 minimum (20 A)	As required
Output load wire, AWG 6 minimum, 5000 Vac, L-824 type (6.6 A); AWG 8 minimum (20 A)	As required

Table 2: Required Equipment Not Supplied (Continued)

Description	Quantity
Shorting jumper wire, AWG 8 minimum	As required
Disconnect switch or main circuit breaker	1
Voltmeter, 60 Vdc full scale	1
Ammeter, true-rms-reading, 9 A maximum scale	1
Inductive-type current probe	1
Ohmmeter	1
Mounting bolts, ½-16 x 1-1/2 in. long, ½ STD washers, and lock washers	4

2.16 Input Wire Size

Input Wire Size refers to recommended input power supply wire size for each regulator power rating dependent on the input voltage. This recommendation is based on 75°C rated copper wire per NEC Table 310.16.

Table 3: Recommended Input Wiring Rating

Power Rating	208 Vac	220 Vac	240 Vac	347 Vac	380, 400 Vac	480 Vac
4 kW	AWG 10	AWG 10	AWG 10 ²	AWG 12 ²	AWG 12 ²	AWG 14 ²
7.5 kW	AWG 6	AWG 8	AWG 8	AWG 8	AWG 8	AWG 10 ²
10 kW	AWG 4	AWG 6	AWG 6	AWG 8	AWG 8	AWG 10
15 kW	AWG 3	AWG 3	AWG 4	AWG 6	AWG 6	AWG 8
20 kW	AWG 2/0	AWG 1/0	AWG 2	AWG 4	AWG 4	AWG 6
30 kW	AWG 3/0	AWG 3/0	AWG 2/0	AWG 2	AWG 2	AWG 4

2.17 Input Power Breaker Sizing

It is recommended that the circuit breaker on the input power supply lines have a rating of 125% of the CCR's input current, as given in [Table 4](#), unless local codes require a different rating technique. Refer to the CCR's nameplate for the kW rating and input voltage to determine the actual input current from [Table 4](#). If no standard-size circuit breaker exists at the 125% value, use the next larger standard-size circuit breaker.

Note

The currents listed in [Table 4](#) represent actual input currents assuming the worst case limits of AC 150/5345-10 for power factor, efficiency, and number of required lamps out.

Table 4: CCR Input Voltage and Current for the CCR Power Ratings

Power Rating	208 Vac	220 Vac	240 Vac	347 Vac	380 Vac	400 Vac	480 Vac
4 kW	27 A	26 A	24 A	16 A	15 A	14 A	12 A
7.5 kW	51 A	48 A	44 A	31 A	28 A	26 A	22 A
10 kW	68 A	65 A	59 A	41 A	37 A	35 A	30 A

² * Increased 1 wire size to comply with small conductor limits in NEC 240.4.D.

Table 4: CCR Input Voltage and Current for the CCR Power Ratings (Continued)

Power Rating	208 Vac	220 Vac	240 Vac	347 Vac	380 Vac	400 Vac	480 Vac
15 kW	97 A	92 A	84 A	58 A	53 A	50 A	42 A
20 kW	129 A	122 A	112 A	78 A	71 A	67 A	56 A
30 kW	190 A	179 A	164 A	114 A	104 A	98 A	82 A

2.18 Specifications

This subsection provides specifications for L-828/L-829 CCR (4-70 kW 6.6 A/20 A).

Table 5: Class, Style and Power Ratings

Class	L-828/L-829 CCR Max Output Current	Style	Brightness Steps	Nominal Output Current	Power Ratings
1	6.6 A	1	3	4.8 A, 5.5 A, 6.6 A	4, 7.5, 10, 15, 20 and 30 kW
		2	5	2.8 A, 3.4 A, 4.1 A, 5.2 A, 6.6 A	

Table 6: Power Factor

CCR	Power Factor
4 - 10 kW	0.90 minimum
15 - 30 kW	0.95 minimum

2.18.1 Efficiency

The efficiency of the regulator operated with rated input voltage into a full load having unity power factor is not less than the value shown in [Table 6](#).

Table 7: Efficiency

CCR	Efficiency
4-20 kW	0.90 minimum
30 kW	0.92 minimum

2.18.2 Reactive Loading

The CCR maintains the output current within the limits of [Table 8](#) for all brightness steps when the load is connected via isolating transformers, and the secondaries of 30 percent of the transformers become open-circuited. The load before opening the isolation transformer secondaries may be any value from half to full load. For regulators less than 10 kW loaded as specified above, the current remains below 6.8 amperes for the 100 percent brightness step.

Table 8: Output Current and Limits

Class	Style	Step	Nominal output amperes (A) root mean square (RMS)	Allowable range (A RMS)
1	1	B100	6.6	6.5 - 6.7
		B30	5.5	5.4 - 5.6
		B10	4.8	4.7 - 4.9

Table 8: Output Current and Limits (Continued)

Class	Style	Step	Nominal output amperes (A) root mean square (RMS)	Allowable range (A RMS)
1	2	B5	6.6	6.5 - 6.7
		B4	5.2	5.1 - 5.3
		B3	4.1	4.0 - 4.2
		B2	3.4	3.3 - 3.5
		B1	2.8	2.7 - 2.9

2.18.3 Resistive Loading

The regulator maintains the output current within the limits of [Table 8](#) while powering any load between no load (or short circuit) and full load. For regulators 10 kW or larger, the regulation is maintained over the full range of environmental conditions specified in this section and for the input voltages specified in [Table 4](#). For regulators less than 10 kW, the regulation is provided at nominal input voltage for all brightness steps.

2.18.4 Regulation

Refer to [Table 8](#) for output current limits. Current regulation is obtained under the conditions listed in [Environmental Operating Conditions](#).

2.18.5 Environmental Operating Conditions

The L-828 CCRs are designed for indoor use only in an area with adequate ventilation for cooling the constant current regulator. The environmental operating conditions include temperature range, relative humidity, and altitude.

Table 9: Environmental Operating Conditions

Temperature Range		Relative Humidity	Altitude
Without monitoring circuitry	With monitoring circuitry		
-40 to +55 °C (-40 to +131 °F)	0 to +55 °C (-18 to +131 °F)	10 to 95% (non-condensing)	Sea level to 6,600 ft (2000 m)

2.18.6 Protection Devices

L-828 CCRs have the following protection devices:

- Output open-circuit protection.
- Output overcurrent protection.
- Lightning arrestors on output terminals and bushings.
- Lightning arrestors on input terminals.
- Fuse protection of AC supply voltage of the CCR Control PCB and brightness control voltage for Remote control.

2.18.7 Open-Circuit Protection

The regulator includes an open-circuit protective device to open the primary switch within 2 seconds after an open circuit occurs in the secondary. The device resets within 2 seconds after the control switch is turned off and re-energized, and cannot be tripped by switching the load circuits or other transients.

2.18.7.1 Overcurrent Protection

Regulators include an overcurrent protective device that opens the primary switch when the output current exceeds the 100 percent current (6.6 A) by 5 percent. The device operates within 5 seconds after an overcurrent of 5 percent and within 1 second after an overcurrent of 25 percent. The device resets within 2 seconds after the control switch is turned off and re-energized. The overcurrent protection cannot be activated by a momentary (0.25 second) overcurrent caused by switching the load circuits and other transients.

2.18.8 Input Voltage

Input voltage is single phase 50 or 60 Hz ac. Regulators operate as required (see subsections [Resistive Loading](#) and [Reactive Loading](#) in this section) when the input voltage is anywhere between 95 and 110 percent of the nominal value. The regulator is designed to withstand momentary voltages up to 120 percent of nominal input voltage without shutting off or being damaged by such overvoltage so long as the duration of overvoltage excursions are not longer than 50 milliseconds and do not occur more than once per minute.

Thyristor Regulators are configured for either 50 or 60 Hz operation at the factory. Contact ADB for additional information or changing the input frequency.

2.18.8.1 Built-In True-rms-Reading Ammeter, L-828 only

For the L-828 only, a flush-mounted true-rms-reading ammeter mounted on the front of the input module PCB indicates the output current. The meter accuracy is ± 3.0 percent of the maximum output current.

2.18.9 Temperature Rise

The temperature rise of the transforming portion of the regulator is in accordance with ANSI C57.12.91 for air-cooled regulators.

3.0 Installation Overview

Recommend lifting for regulators is to use a forklift from underneath the CCR frame. Lifting points, four 3/4-inch ID eye-bolts on the top corners of the CCR frame, are provided per FAA specifications. If lifting eye bolts are used, use either a portable hoist and sling(s) or sling(s) attached from forks on forklift. See [Table 12](#), for CCR weight before lifting.



WARNING

Read installation instructions in their entirety before starting installation.

- If lift points (eye bolts) are used, lift straight up. Side loading on the eye bolts may cause them to bend.

Place the regulator inside a well ventilated room with sufficient clearance for personnel to inspect and maintain the unit.

3.1 Intended Use



CAUTION

Use this equipment as intended by the manufacturer

This equipment is designed to perform a specific function, do not use this equipment for other purposes

- Using this equipment in ways other than described in this manual may result in personal injury, death or property and equipment damage. Use this equipment only as described in this manual.

Failure to follow this instruction can result in serious injury or equipment damage

3.2 Unpacking

The equipment is shipped ready for installation. Handle equipment very carefully to prevent component damage. Unpack the carton upon receipt and check the contents and their condition. Note any exterior damage to the carton that might lead to detection of equipment damage.

If you note any damage to any equipment, file a claim with the carrier immediately. The carrier may need to inspect the equipment.



Note

Take care to maintain the unit in an upright position when handling the regulator.

3.3 Material Handling: Heavy Equipment



DANGER

Unstable load

Use caution when moving heavy equipment

- Use extreme care when moving heavy equipment.
- Verify that the moving equipment is rated to handle the weight.
- When removing equipment from a shipping pallet, carefully balance and secure it using a safety strap.

Failure to follow this instruction can result in death, serious injury, or equipment damage

3.4 Installation Overview

Recommend lifting for the 4 thru 30kW regulators is to use a forklift from underneath the CCR frame. Lifting points, four 3/4-inch ID eye-bolts on the top corners of the CCR frame, are provided per FAA specifications. If lifting eye bolts are used, use either a portable hoist and sling(s) or sling(s) attached from forks on forklift. See [Table 12](#), for CCR Weight before lifting.



WARNING

Read installation instructions in their entirety before starting installation.

- If lift points (eye bolts) are used, lift straight up. Side loading on the eye bolts may cause them to bend.

Place the regulator inside a well ventilated room with sufficient clearance for personnel to inspect and maintain the unit.

3.4.1 Wiring Connections and Startup



WARNING

Read installation instructions in their entirety before starting installation.

- Installation and operation of the CCR should be performed by personnel qualified to work on high voltage equipment. The high voltage involved with the unit makes it potentially dangerous and may be lethal if contacted by operating personnel.
 - Place wiring for output, input, and remote control only on the right side of the CCR to prevent damage to the PCB that is located on the front Left side of the enclosure. If output, input, and remote control wiring must enter from the left side of the enclosure then wiring must be then routed through conduit where it passes the PCB area. See [Figure 1](#).
-

To install wiring, perform the following procedure:

1. Verify the input supply voltage corresponds to the voltage rating on the nameplate of the regulator.
2. Make sure the front panel rotary selector switch is set to the OFF position.
3. Ground the regulator by making an adequate ground wire (AWG 6 or larger) connection to the external earth ground lug on the regulator.
4. An appropriate disconnect-type cutout or circuit breaker shall be provided outside the regulator for the input power supply lines.
5. Short-circuit the output terminals TB2-1, TB2-2 using 8 AWG minimum wire to avoid lamp destruction in case of excessive current output.
6. Refer to [Input Wire Size](#) for the recommended input wire.

Connect the power supply lines from the disconnect switch or main circuit breaker to the CCR input fuse block F1/F2 or terminal block TB3. Tighten all connections.

Figure 6: Wiring on Right Side of the CCR

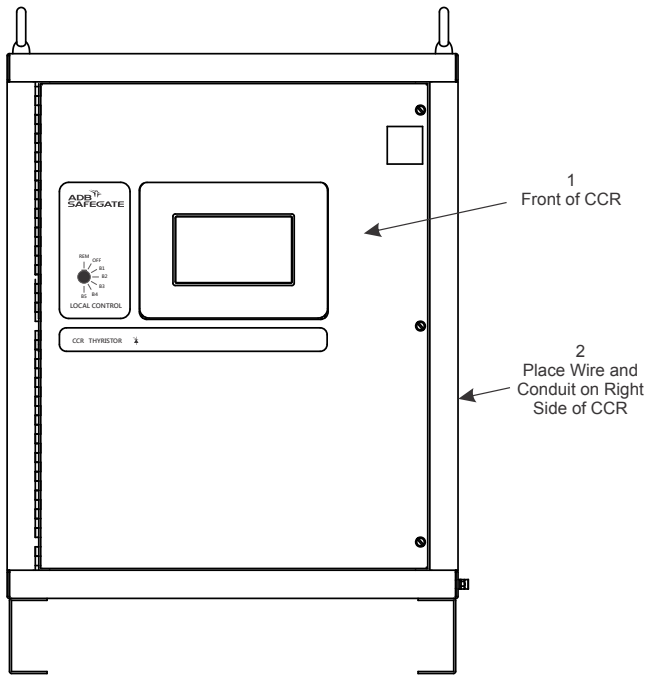

7. Engage main circuit breaker or disconnect switch to energize the regulator.
8. Turn front panel rotary selector switch to all brightness steps, and verify that current values on the panel ammeter correspond to those in [Table 8](#) for each brightness step.
9. Disengage the main current breaker or disconnect switch to de-energize the regulator.
10. Turn the rotary selector switch to OFF.
11. Connect remote control lines, if required, to remote control terminal block TB1.

Use AWG 18, 300 V wire or larger for 120 Vac signals. See [Figure 1](#) and [Figure 3](#) in the “Schematics” section for remote control connections.



Note

If the ADB Safegate Advanced Control Equipment (ACE) is used with the Ferroresonant L-828 CCR, refer to the Advanced Control Equipment manual (ACE) manual for wiring connections to remote control.

[Table 38](#) and [Table 3](#) provide the necessary connections for remote control. Terminal B1 (B10) does not need to be wired. Brightness step B1 (B10) occurs when the regulator is switched on.

Table 10: Remote Control Connections (3-Step/6.6 A)

For this remote intensity step...	Connect CCI to...
LOW (4.8 A)	CC
MEDIUM (5.5 A)	CC, B30
HIGH (6.6 A)	CC, B100
OFF	Not applicable

Table 11: Remote Control Connections (5-Step/6.6 A)

For this remote intensity step...	Connect CCI to...
2.8 A	CC
3.4 A	CC, B2
4.1 A	CC, B3
5.2 A	CC, B4
6.6 A	CC, B5
OFF	Not applicable

12. Make sure wiring connections are tight and no wires are shorting across each other.



CAUTION

Read installation instructions in their entirety before starting installation.

- Incorrect wiring can damage regulator. Double check all connections.

13. Energize regulator and set rotary selector switch to REM.

Operate the CCR by remote control, and verify correct current levels are obtained on all brightness steps.

14. Turn rotary selector switch to OFF and de-energize regulator (disengage disconnect switch or main circuit breaker).

Remove short-circuit link between output terminals TB2-1 and TB2-2.

15. Connect the 6.6 A or 20 A series lighting circuit to the output terminals/ bushings and tighten all connections.

Table 12: Input/Output Connections

CCR Design	Input Location	Output Location
With SCO	Top of each Fuse Block front of component plate right hand side	Bottom of SCO Lightning Arrestors
Without SCO		(VR1 and VR2) on Back of component plate

3.5 Stacking Information

CCRs can be stacked to minimize the floor space required in a vault. Standard 3/8"-16 x 3/4" hex head bolts are used to secure the regulators together. Regulators can only be stacked two high.

The following hardware is required to complete the stacking task:

- 1/2" or 13mm socket, 3/8" drive
- 3/8" drive ratchet
- (4) 3/8"-16 x 3/4" Hex Head Bolts
- (4) 3/8" Flat Washers
- (4) 3/8" Lockwashers

To stack two regulators, complete the following steps:

1. Remove 4 eyebolts from bottom regulator. Retain all hardware.
2. Carefully stack top regulator onto bottom regulator.
3. Bolt the top regulator to the bottom regulator with the 3/8" bolts and washers.

4.0 CCR Operation

This section provides the operational procedures listed below for the L-828/L-829 constant current regulator (CCR) (4-30 kW).

- CCR control procedures
- CCR shutdown procedures
- CCR adjustment procedures
- SCO cutout working positions

4.1 Operation Safety



CAUTION

Improper Operation

Do Not Operate this equipment other than as specified by the manufacturer

- Only qualified personnel, physically capable of operating the equipment and with no impairments in their judgment or reaction times, should operate this equipment.
- Read all system component manuals before operating this equipment. A thorough understanding of system components and their operation will help you operate the system safely and efficiently.
- Before starting this equipment, check all safety interlocks, fire-detection systems, and protective devices such as panels and covers. Make sure all devices are fully functional. Do not operate the system if these devices are not working properly. Do not deactivate or bypass automatic safety interlocks or locked-out electrical disconnects or pneumatic valves.
- Protect equipment with safety devices as specified by applicable safety regulations.
- If safety devices must be removed for installation, install them immediately after the work is completed and check them for proper functioning.
- Route electrical wiring along a protected path. Make sure they will not be damaged by moving equipment.
- Never operate equipment with a known malfunction.
- Do not attempt to operate or service electrical equipment if standing water is present.
- Use this equipment only in the environments for which it is rated. Do not operate this equipment in humid, flammable, or explosive environments unless it has been rated for safe operation in these environments.
- Never touch exposed electrical connections on equipment while the power is ON.

Failure to follow these instructions can result in equipment damage

4.2 CCR Control Procedures

This subsection describes the regulator operations in local and remote controls.

4.2.1 Local Control

See [Figure 1](#). Refer to [Table 1](#) and [Spare Parts](#) for output current when using local control. The front panel rotary selector switch is used for regulator local control. The rotary switch for the 3-step CCR has five positions; the rotary switch for the 5-step has seven positions. The regulator automatically maintains the output current within $\pm 1\%$ of the nominal value for the brightness position selected.

Figure 7: L-828/L-829 Switches

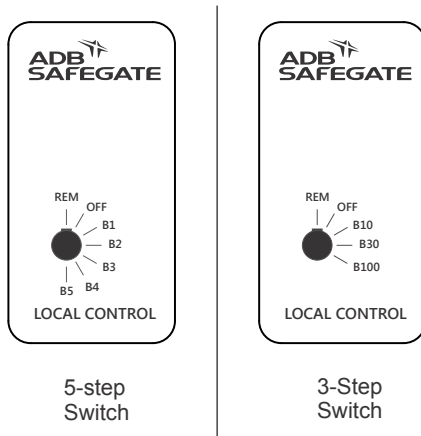

Table 13: Output Current from Rotary Switch (3-Step/6.6 A)

If you set the rotary switch to the following...	The result is...
B10	4.8 A current output
B30	5.5 A current output
B100	6.6 A current output
B4	Not Used/Blocked
B5	Not Used/Blocked

Table 14: Output Current from Rotary Switch (5-Step/6.6 A)

If you set the rotary switch to the following...	The result is...
B1	2.8 A current output
B2	3.4 A current output
B3	4.1 A current output
B4	5.2 A current output
B5	6.6 A current output

4.2.2 Remote Control

See Remote Control Table for instructions on how to set up and use the CCR remote control.

Table 15: Remote Control

If...	Then...
The rotary switch is set to position REM and remote control wiring is connected to remote control terminal block TB1 on the regulator	Remote control of the regulator is possible. The output current of the regulator will correspond to the brightness setting energized by remote 120 Vac or 48 Vdc control signals.
Switch is set to OFF	Remote control signals will not operate the regulator; that is, turn the regulator on to a particular brightness setting or turn the regulator off.
No remote control connections exist on terminal block TB1 (switch is set to REM)	The position REM becomes an additional OFF position; that is, the regulator is de-energized.

4.2.3 CCR Shutdown Procedure

See Figure in Local Control. To shut down the CCR, set the rotary switch to position OFF.

NOTE: Power to the output terminals is now off, and the regulator cannot be energized by remote control signals.



CAUTION

Caution Power is still present on the input power terminals and on the internal control circuitry.

To remove input power, disengage disconnect switch or external circuit breaker.

4.3 CCR Adjustment Procedures

This subsection provides regulator adjustment procedures.

Note

The regulator has been adjusted at the factory to provide the nominal output current levels as given in Table 16. If the current level settings need to be adjusted, read the following warning statement before proceeding.

CAUTION

Read the instructions in their entirety before starting calibration procedures.

Only personnel qualified to work on high voltage systems should attempt to make any adjustments on the constant current regulator.

Turn the rotary selector switch on the front panel of the regulator to position OFF. Remove input power before servicing control circuitry.

Never service the regulator when it is in protective shutdown mode, Remote controls or power fluctuations can restart the regulator.

To adjust the output current, perform the following procedure:

1. Connect a clamp-on true RMS reading instrument (such as a Fluke 87 multimeter with a current clamp) around one of the output current leads. See Figure 24.
2. If the optional current clamp test point is present the clamp-on instrument on the CCR component plate should be utilized.

Figure 8: Output Current Clamp

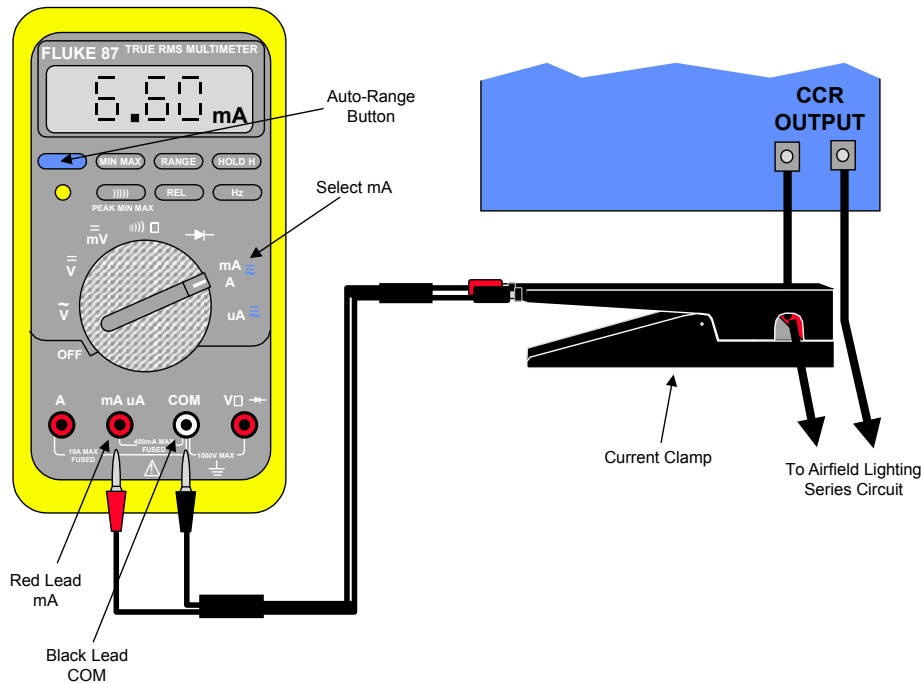

Note

Make sure the meter is set on the AC current scale.

Because the output current waveform is not a true sine wave, the ammeter must be of the True-RMS (root mean squared) type. Field instruments such as clamp-on ammeters and Simpson voltmeters will give erroneously low readings.

4.3.1 Adjusting Output Current (no ACE3)

Current adjustments on regulators with ACE3 must be done from the ACE3 touchscreen display (see the ACE3 manual 96A0500 in our product center at www.adbsafegate.com).

Figure 9: Regulator URC4 Control PCB

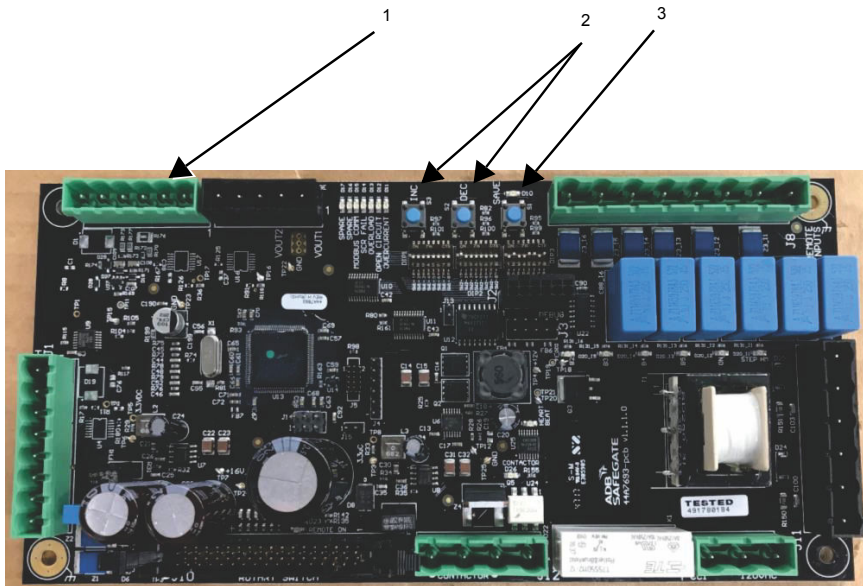

To adjust the output current of Regulator Control Board, perform the following procedure:

1. For 3-step operation, verify that DIP switch Bank 1 Position 2 is ON. For 5-step operation, verify that DIP switch Bank 1 Position 2 is OFF. .
2. Turn on the CCR and set local control switch to the highest intensity step, B5 for 5-step CCR, B100 for a 3-step CCR.
3. The external True-RMS ammeter should read 6.60 ± 0.1 amps or 20 ± 0.3 amps for 20A regulators. If the reading is outside of this range, adjust the output current with buttons INC and DEC (Figure 23, Item 2) on the Control PCB until the correct current is obtained. Press and hold the SAVE button (Figure 23, Item 3) for two seconds to save the setting.
4. Turn off the CCR. Remove the short from the output and apply the field load.
5. Again, turn on the CCR and set local control switch to the highest intensity step, B5 for 5-step CCR, B100 for a 3-step CCR.
6. The external True-RMS ammeter should read 6.60 ± 0.1 amps or 20 ± 0.3 amps for 20A regulators. If the reading is outside of this range, adjust the output current with buttons INC and DEC (2) on the Control PCB until the correct current is obtained. Press and hold the SAVE button (3) for two seconds to save the setting.

NOTE: Each CCR output current step is independently adjustable and must be independently saved.

7. Set the local switch to next to the lowest brightness step, and verify that the True-RMS ammeter reading corresponds to current tables.
8. If the reading is not in the current value range given in the Tables, adjust the appropriate step until the correct current value is obtained.
9. Repeat Step 2 for the remaining lower brightness step(s).

When the output current adjustment has been completed, turn off the CCR.

4.3.2 Adjusting Overcurrent Control Board (44A6546)

ADJUSTING THE CCR OVER CURRENT DETECTION LEVEL

Before adjusting the Over Current Detection level, set up the regulator and adjust the output current per the **ADJUSTING THE CCR OUTPUT CURRENT** section of this section.

i Note

The Over Current setting is pre-set and should normally not need adjusted.

To adjust the overcurrent, perform the following procedure:

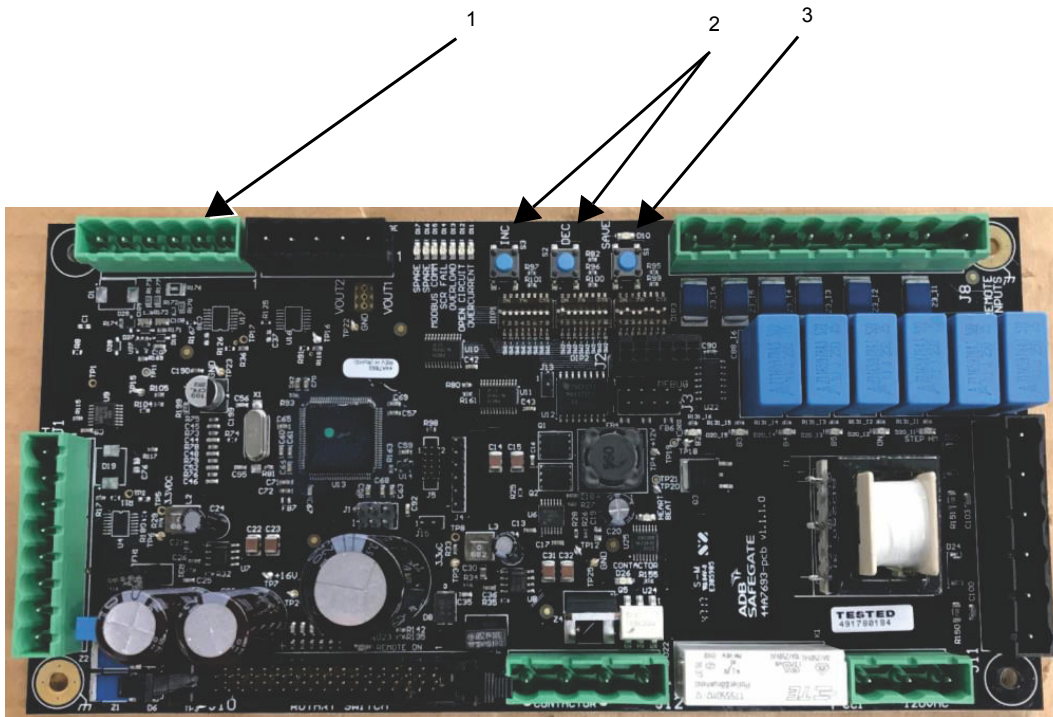

1. Short the output of the CCR so the field load cannot be damaged by an over current situation during the adjustment.
2. Turn the local switch to the highest brightness step, B5 for 5-step CCR, B100 for a 3-step CCR.
The true-RMS ammeter should read 6.6 amps.
3. Press and hold for three seconds both the INC (2) and DEC (2) buttons.
The LED next to the SAVE (3) button will light when you are in the Over Current Adjustment Mode. **NOTE:** The CCR output current will increase to the level previously set as the Over Current level. This will be above 6.6 amps.
4. Press the INC (2) or DEC (2) buttons until you reach the desired Over Current detection level.
5. Press and hold the SAVE (3) button for two seconds.
The SAVE LED will go out and the CCR output will go back to the top step setting of 6.6 amps.
6. Remove the short from the CCR output and apply the field load.

4.3.3 Reducing CCR Power Consumption

To reduce the CCR power consumption the transformer output can be adjusted in 10 per cent increments to match applied loads. The power consumption will approximately drop with respect to the output percentage selected. See the following table and diagram to reduce the CCR power consumption.

Percent of Transformer Rated Load	Connect HV (6.6A) Output Across Terminals
10	5 and 6
20	3 and 4
30	1 and 2
40	3 and 6

Percent of Transformer Rated Load	Connect HV (6.6A) Output Across Terminals
50	2 and 4
60	2 and 5
70	2 and 6
80	1 and 4
90	1 and 5
100	1 and 6

Figure 10: CCR Transformer Taps

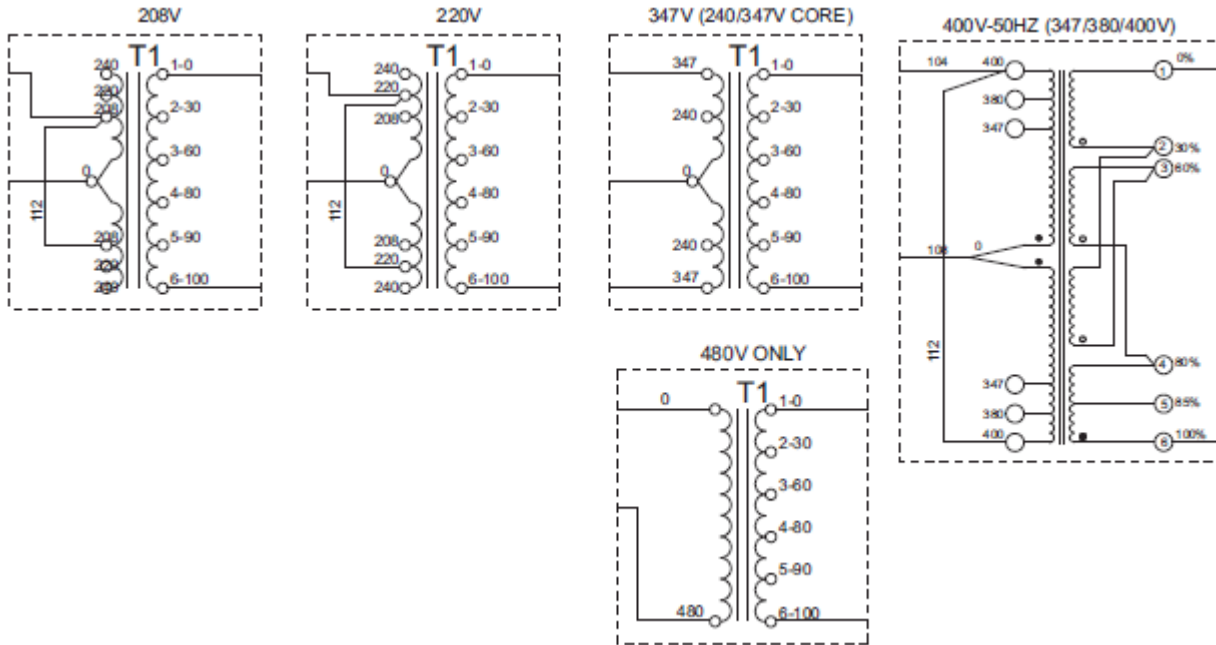

4.4 SCO Operation

This subsection provides the SCO cutout working positions.



DANGER

ARC FLASH AND ELECTRIC SHOCK HAZARD

Allow only qualified personnel to perform maintenance, troubleshooting, and repair tasks.

- Only persons who are properly trained and familiar with ADB Safegate equipment are permitted to service this equipment.
- An open airfield current circuit is capable of generating >5000 Vac and may appear OFF to a meter.
- Never unplug a device from a constant current circuit while it is operating. Arc flash may result.
- Disconnect and lock out electrical power.
- Always use safety devices when working on this equipment.
- Follow the recommended maintenance procedures in the product manuals.
- Do not service or adjust any equipment unless another person trained in first aid and CPR is present.
- Connect all disconnected equipment ground cables and wires after servicing equipment. Ground all conductive equipment.
- Use only approved ADB Safegate replacement parts. Using unapproved parts or making unapproved modifications to equipment may void agency approvals and create safety hazards.
- Check the interlock systems periodically to ensure their effectiveness.
- Do not attempt to service electrical equipment if standing water is present. Use caution when servicing electrical equipment in a high-humidity environment.
- Use tools with insulated handles when working with airfield electrical equipment

Failure to follow these warnings will result in death or equipment damage.

Refer to [Table 16](#) for the different working positions.



WARNING

Switch off the constant current regulator before manipulating the cutout.

Table 16: Cutout Working Positions

	Position A	Position B	Position C
Mode of operation	Allows the regulator to deliver current to the series circuit.	Maintenance can be done safely on the series circuit.	The series circuit insulation versus ground can be measured by applying the measurement voltage, max 9000 V DC, between the measurement socket (Item 3, Figure 2) and the ground strip (Item 8, Figure 2).
Diagram			
Cover			
Handle is	horizontal	turned 90° CCW from position A	turned 270° CCW from position A
The series circuit is	connected to the CCR	Disconnected from the CCR, shorted and grounded	disconnected from the CCR, shorted and connected to the measurement socket (Item 3, Figure 2)
The CCR is	delivering current to the series circuit	shorted and grounded	shorted and grounded
The interlock switch is	activated and allows the CCR to be ON	not activated and inhibits the CCR to be ON	activated and allows the regulator to be ON (operation in short circuit)
The cover	can be locked by the key	can be locked by the key	can be locked by the key

Notes

- The position of the cover intermediate between B and C, that is, turned 180 degrees from position A, cannot be used and the cover cannot be plugged into the body.
- An activated interlock switch means that the normally open contact is closed and that the normally closed contact is open. For interlocking with the CCR, only the normally open contact will be used.

5.0 Graphics User Interface (GUI)

The ACE3 graphic user interface (GUI) consists of a 7-inch 800 x 480 pixel full-color LCD touchscreen. In typical modes of operation, the ACE3 will display several tiles, which contain all available output data. The user can select the individual tiles to make it more prominent on the screen. Other data available on the screen include:

- Brightness step
- Remote/Local
- Primary power present / loss of power
- Communication
- IRMS status
- CCR Cycle Count
- Total Run Time
- Run Time per Step

The ACE3 GUI also contains a localized event database to allow the user to view alarms/warnings for the individual device without the need to interface with the higher level control system.

HMI Screen Map

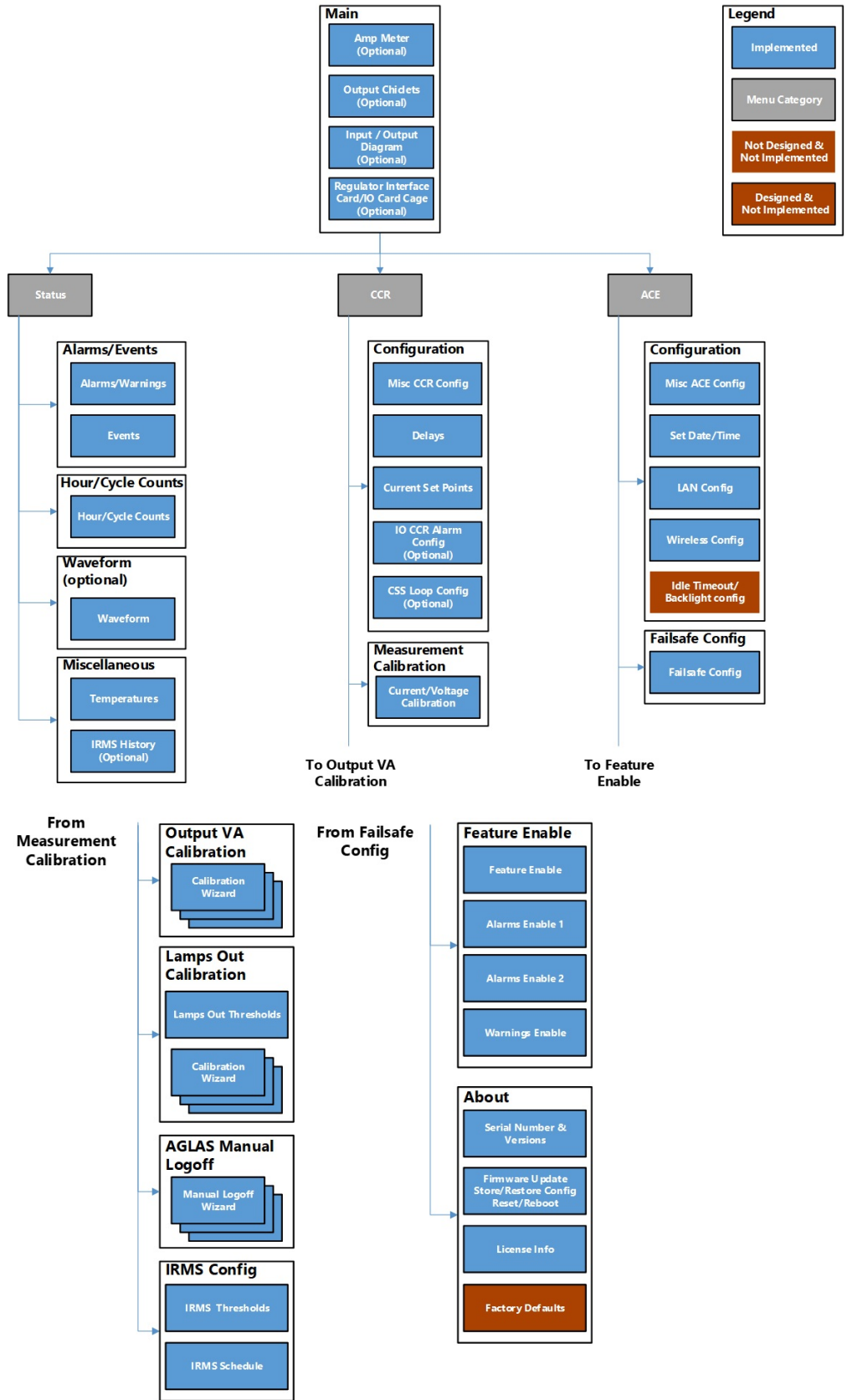

Main Display



The main screen is the first usable screen (not the splash screen) the user sees after starting the ACE3 (except when in L828 Display mode). The page is laid out with a header at the top and the body below it. The body contains a large display which shows the primary item being monitored.

There are four views associated with the main screen which can be shown or hidden based on the ACE3 configuration.

Figure 11: Output Current Gauge

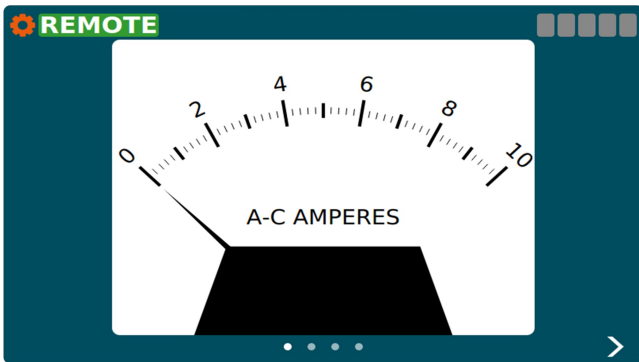

This view is shown when the ACE3 mode is "CCR" and the display mode is L828 or when the "Display Analog Current Gauge" feature is enabled.

Figure 12: Output View and Diagram View

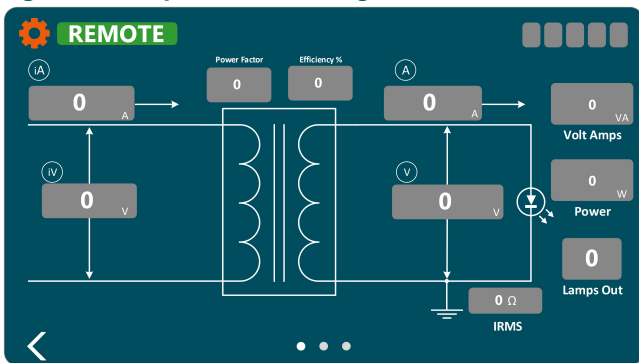

These views are shown when the ACE's mode is "CCR". The first view shows all of the output power related applications. The second view contains input power (if enabled) and output power values arranged on an electrical diagram. If the ACE's mode is "IO" neither the Output View nor the Diagram View will be displayed.

Figure 13: IO Card Cage View

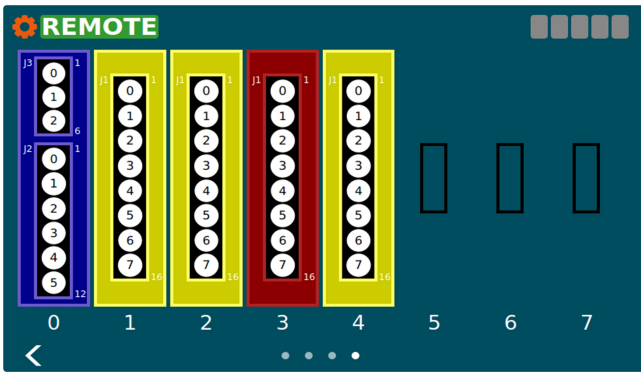

This view is shown when an IO card cage is installed. It shows what type of card is installed in which slot. Blue = Regulator Interface Card, red = output card, yellow = input card. These colors correspond to the actual color of the PCB. If the ACE's Mode is "IO" the outputs on the Regulator Interface Card and output cards can be toggled by touching the circle corresponding to the channel. The user will have to be in control before they can change the output. Touching an output while not in control causes the "Override Control" popup to be opened asking the user to take control. The channels on the output cards will turn red and input cards will turn green when the channel has gone high.

Figure 14: Regulator Interface Card View

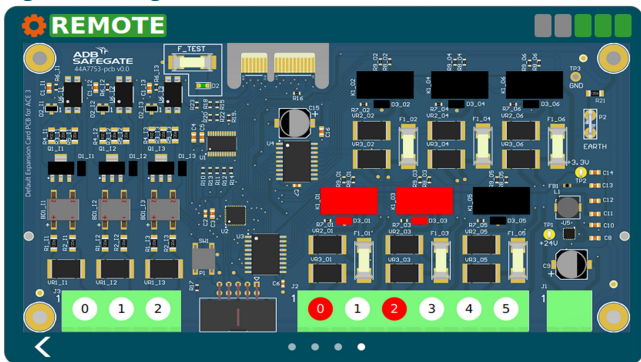

This view is shown when only the Regulator Interface Card is installed with no card cage. If the ACE's Mode is "IO" the outputs on the Regulator Interface Card can be toggled by touching the circle corresponding to the channel. The user will have to be in control before they can change the output. Touching an output while not in control causes the "Override Control" popup to be opened asking the user to take control. The board components, LED, and channel indicator on the card will turn red for outputs and green for inputs when activated.

Figure 15: Regulator Interface Card View (4x4 Card)

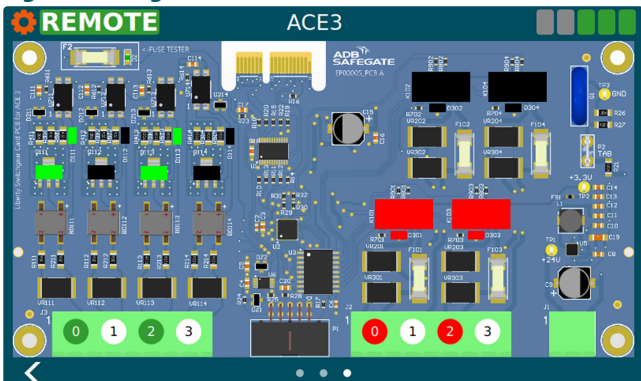

This view is shown when only the 4x4 Regulator Interface Card is installed in a URC4 integrated CCR. The user will have to be in control before they can change the output. Touching an output while not in control causes the "Override Control" popup to be opened asking the user to take control. The board components, LED, and channel indicator on the card will turn red for outputs and green for inputs when activated.



The user can switch between pages by using the navigation arrows at the bottom left and right of the screen. A page indicator located at the bottom center of the screen shows which page the user is on.

5.1 Menu Screen

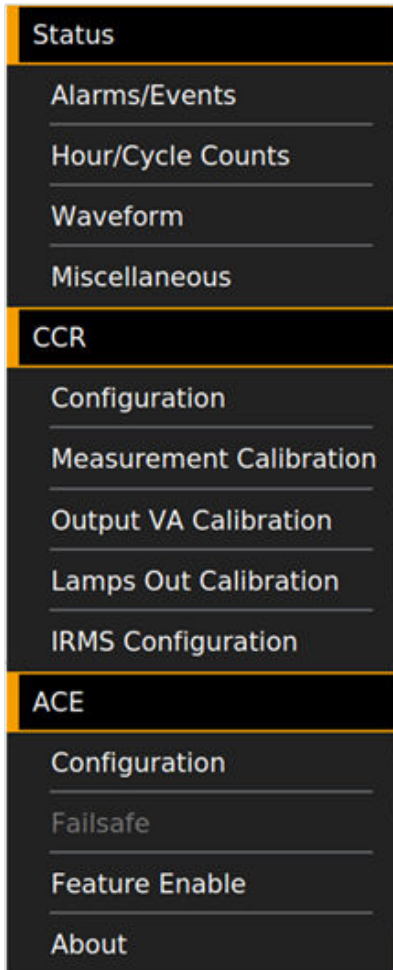
Menu Overview



The menu will allow the user to navigate away from the main screen to various status and config screens. It is broken down into three sections "Status", "CCR", and "ACE". Under each section will be screens related to the section title.

The menu will slide out from the left of the screen when the user presses the  icon. The menu will slide back off the screen after the user has touched somewhere outside of the menu. Selecting an item from the menu will replace the main screen with the chosen screen. The menu icon  will change to a left pointing arrow  indicating you can go back from the newly opened screen.

Status

Alarms/Events – This will display the Alarms/Warnings/Events pages

Hours/Cycle Counts – This will display the built-in Hour/Cycle counter

Waveform – This will display a graphical representation of the input and output electrical characteristics

Miscellaneous – This page displays the internal temperature page and IRMS Viewer page

CCR

Configuration – This displays the page used for configuring CCR parameters

Measurement Calibration - This displays the page used for calibrating the output measurement of the CCR

Output VA Calibration - This displays the page used for calibrating the VA measurement of the CCR

Lamps Out Calibration - This displays the page used for calibrating Lamps Out

IRMS Configuration - This displays the page used for configuring IRMS schedule and parameters

ACE

Configuration – This displays the page used for configuring ACE parameters

Failsafe - This displays the page used for configuring failsafe parameters

Feature Enable - This displays the page used for enabling/disabling features, as well as enabling/disabling desired warnings and alarms

About – This page displays serial number and firmware information, as well as backup and restore functions

5.1.1 Alarms View

Figure 16: Alarms and Warnings Screen (Alarms View)

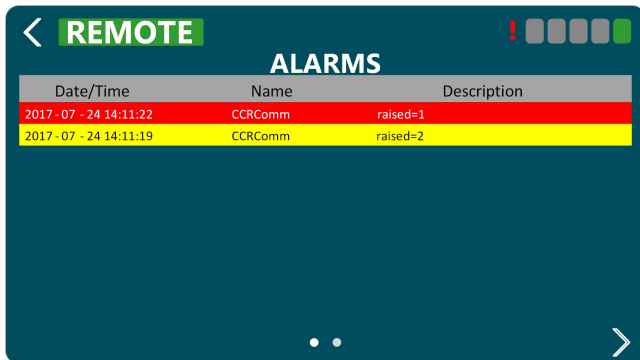

The screenshot shows a mobile application interface with a dark blue header. On the left is a back arrow and the word 'REMOTE' in green. On the right is a status bar with a red exclamation mark and four colored indicators (grey, grey, grey, green). Below the header is the title 'ALARMS' in white. A table with three columns: 'Date/Time', 'Name', and 'Description' is displayed. The first row is red and the second is yellow. Below the table are two white dots and a right-pointing arrow.

Date/Time	Name	Description
2017-07-24 14:11:22	CCRComm	raised=1
2017-07-24 14:11:19	CCRComm	raised=2

The Alarms and Warnings Screen will show all currently active alarms (red) and warnings (yellow).

Columns are follows:

- Date/Time - The date/time the alarm/warning occurred
- Name - The name of the alarm/warning
- Description - A user friendly description of the alarm/warning

The Alarm View shows the user the current alarms and warnings. Alarms/warnings that are cleared will not be shown on this screen. The list of alarms/warnings will be sorted by date/time.

5.1.2 Events View

Figure 17: Alarms and Warnings Screen (Events View)

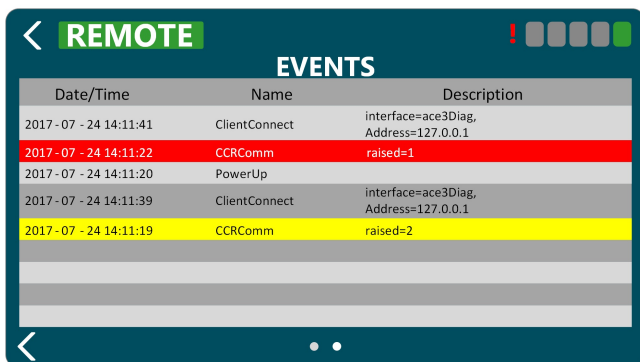

The screenshot shows a mobile application interface with a dark blue header. On the left is a back arrow and the word 'REMOTE' in green. On the right is a status bar with a red exclamation mark and four colored indicators (grey, grey, grey, green). Below the header is the title 'EVENTS' in white. A table with three columns: 'Date/Time', 'Name', and 'Description' is displayed. The rows are color-coded: red, yellow, grey, red, yellow, grey, grey, grey, grey, grey. Below the table are two white dots and a left-pointing arrow.

Date/Time	Name	Description
2017-07-24 14:11:41	ClientConnect	interface=ace3Diag, Address=127.0.0.1
2017-07-24 14:11:22	CCRComm	raised=1
2017-07-24 14:11:20	PowerUp	
2017-07-24 14:11:39	ClientConnect	interface=ace3Diag, Address=127.0.0.1
2017-07-24 14:11:19	CCRComm	raised=2

On the Alarms and Warning screen the event view shows a history of alarms (red), warnings (yellow), and events (grey).

Columns are follows:

- Date/Time - The date/time the alarm/warning/event occurred.
- Name - The name of the alarm/warning/event.
- Data - Information pertaining to the event.

The event view shows the time an alarm or warning started and the time it stopped. Entries which are for started alarms/warnings will be colored red or yellow. Alarms/warnings will have grayed out text and will not be red or yellow when the condition causing them has ended. General informational events will not be colored and will have regular text.

The event view is reachable by navigating right on the Alarms and Warnings Screen.

5.1.3 Status Menu – Hours/Cycle Count

Figure 18: Hour/Cycle Count Screen

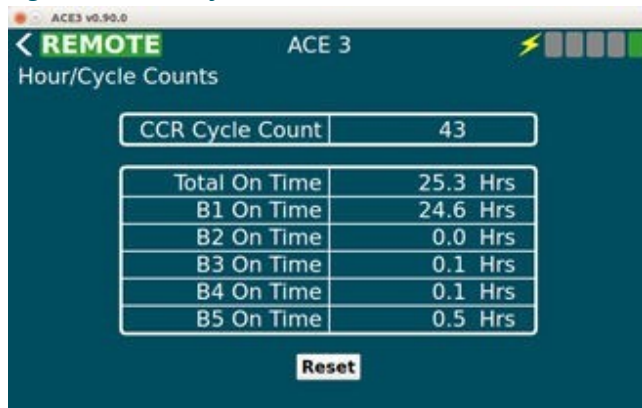

Note

Only the hour counters per step and cycle count will be tracked.

The Hour/Cycle Count screen will consist of one view. This view shows how long the CCR has been on in each step and how many times the CCR was cycled (turned from off to on). At the bottom of the screen there is a reset button which will send a command to reset all statistics.

5.1.4 Status Menu – Waveform

Figure 19: Wave Form Screen

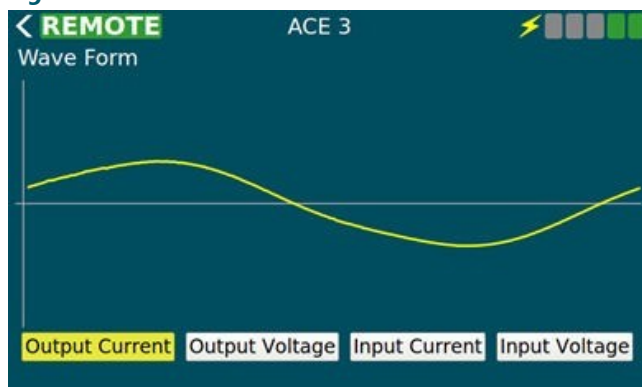

The wave form screen displays a wave form for:

- Output Current
- Output Voltage

- Input Current
- Input Voltage

The data will be in the shape of the wave and won't give exact measurements to the user. There are buttons along the bottom to turn on and off each wave form allowing the user to select which data they wish to view. The display a wave form screen will only update a few times a second to give the user an idea what the wave form looks like but **CANNOT** replace an oscilloscope.

5.1.5 Status Menu – Miscellaneous

Figure 20: Status Menu – Miscellaneous

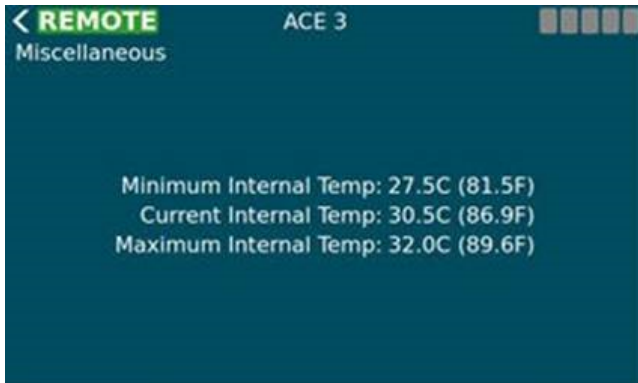

The Miscellaneous screen will contain small items which don't warrant their own page. Logical groups will be broken out into separate views on the miscellaneous page.

The Temperature view displays ambient temperature in both Celsius and Fahrenheit values. It also shows the min and max ambient temperature since the device was started. This information is not persisted through power cycles.

Figure 21: Status Menu – Miscellaneous

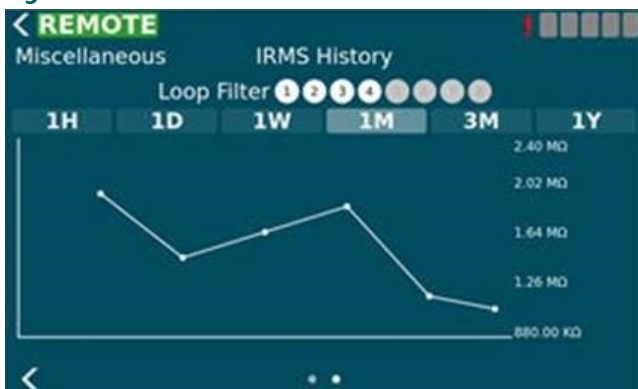

The IRMS History view allows the user to query IRMS data from the past and display it in a graph form so the user can notice trends. The user can select duration of 1 hour to 1 year. If a circuit selector is enabled a loop filter will appear at the top of the view and can be used to filter data based on loops which are being monitored.

5.1.6 CCR Menu - Configuration

The CCR Configuration screen is a set of views used to configure items related to CCR operation. This screen is disabled if the Mode configuration item on the ACE Info Configuration Screen is not set to "CCR" which indicates the ACE 3 is attached to a CCR.

5.1.6.1 Screen 1

The first page has parameters which give general information about the CCR the ACE is attached to.

- Display Mode - This modifies how the HMI presents itself to the user. L828 mode shows the Output Current gauge View only.
- Control Type - How the attached regulator is controlled

- ALCS Enabled - Indicates an ALCS system is connected to the ACE to monitor and control it. Checking this allows the ACE to enter into the failsafe mode when there are not controlling clients.
- Regulation Type - The type of regulator the ACE is connected to. This is disabled when the "Control Type" is "Integrated".
- CCR Class - CCR output current rating. This is disabled when the "Control Type" is "Integrated".
- Total Steps - The max number of steps for the CCR. This is disabled when the "Control Type" is "Integrated".
- CCR Size (W) - The size of the CCR in watts. This is disabled when the "Control Type" is "Integrated".
- CCR Extra IO – This enables communication to the IO backplane for a non-IO ACE mode. ACE mode is set in the ACE configuration menu.

Figure 22: CCR Configuration Screen 1

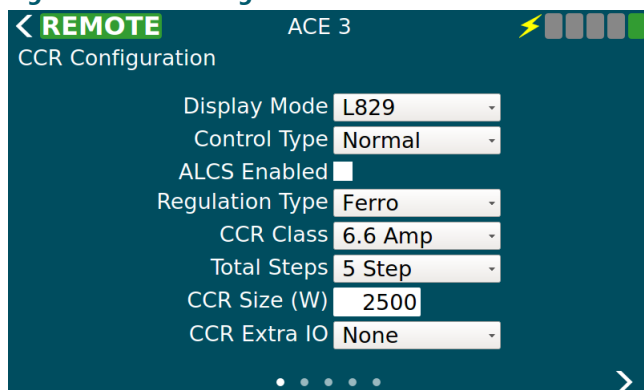

The following table describes the configurable parameters on view 1:

Control	Value	Description
Display Mode	L828	Shows the analog ammeter gauge only
	L829	Shows the full user interface
	ALCS	Currently the same as L829
Control Type	Integrated	ACE is integrated with URC4 and uses serial AIP to control the CCR
	Normal	ACE uses a Default Card to control the CCR
	Separate CC	ACE uses a Default Card and has an IO reserved to CC line
	Binary	Not Implemented yet, will be binary step control
ALCS Enabled	True	Failsafe, as configured, will be enforced Commanded step is displayed in step bars (upper right)
	False	Failsafe is disabled Reported step is displayed in step bars (upper right)
Regulation Type	Ferro	CVM2 will use Ferro Lamps Out Algorithm Lamps Out Calibration will be two phase
	Thyristor	CVM2 will use Thyristor Lamps Out Algorithm Lamps Out Calibration will be three phase
CCR Class	6.6	For 6.6 amp series circuits
	20	For 20 Amp series circuits
Total Steps	3 Step	The CCR has three steps B10, B30, B100
	5 Step	The CCR has five steps B1 - B5
CCR Size (W)	Watts	Sets open circuit voltage set point to 120% value Sets over load voltage set point to 110% value

CCR Extra IO	None	ACE doesn't monitor extra IO slots
	Standard	ACE monitors for output in slot 4, input in slot 6
	Extended	ACE monitors for output in slots 4 & 5, input in slots 6 & 7

Figure 23: CCR Configuration Screen 1 for 20A CCRs

5.1.6.2 Screen 2

The Timings view allows the user to change various delays and timeouts. These timings are for operations such as changing the step or alarm conditions such as how long to stay in a 5% over current condition before generating the Over Current Alarm.

Figure 24: CCR Configuration Screen 2

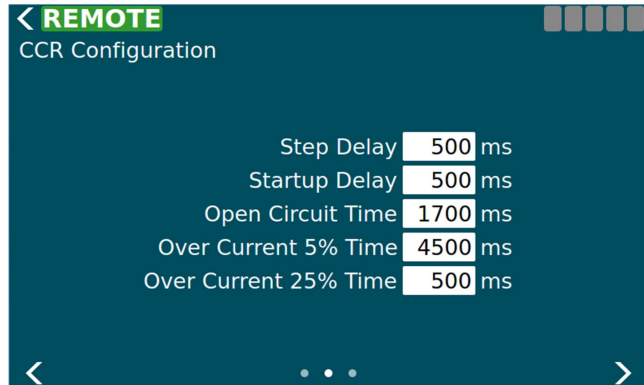

The following table describes the configurable parameters on view 2:

Step Delay	milliseconds	Amount of time to pause between steps when changing CCR step
Startup Delay	milliseconds	Amount of time to pause between off and step 1
Open Circuit Time	milliseconds	Amount of time before open circuit is declared
Over Current 5% Time	milliseconds	Amount of time 5% over before over current is declared
Over Current 25% Time	milliseconds	Amount of time 25% over before over current is declared

5.1.6.3 Screen 3

The Current Set Point view allows the user to change the expected min/max/nominal currents for each step as well as the over current set points for the 5% and 25% over current conditions.

Figure 25: Current Set Point

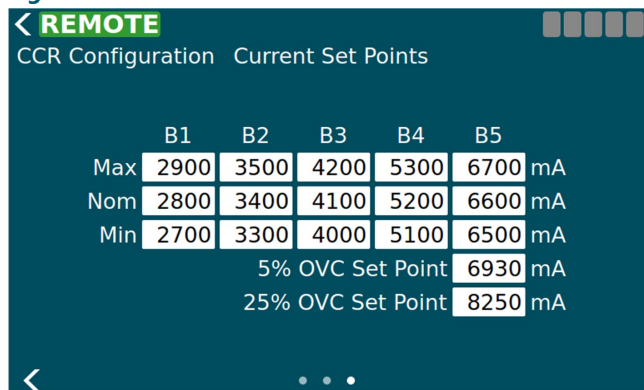
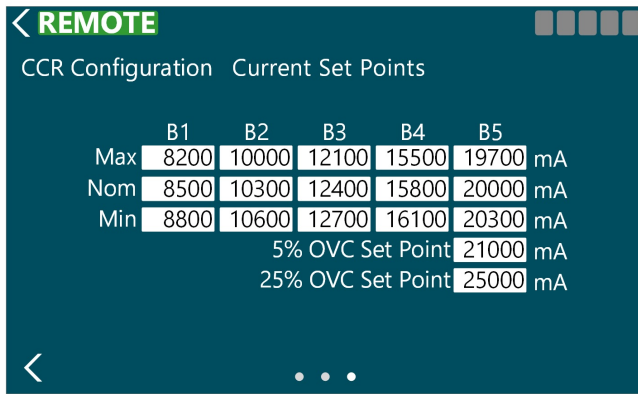

Figure 26: Current Set Point for 20A CCRs



5.1.6.4 Screen 4

The IO CCR Alarm view allows the user to configure alarms to be generated when the state of an input channel changes. The following information is displayed on the page and some things can only be changed when in advanced mode.

- Enabled - If this alarm will be generated based on input state changes.
- Slot - (only in advanced mode) The slot the card occupies in the IO card cage.
- Channel - (only in advanced mode) The channel on the card to monitor for this alarm.
- Polarity- (only in advanced mode) Determines if the alarm is generated when the input channel goes low or high. None of the changes will take effect until the "Set" button has been pressed next to each alarm (default low).

Figure 27: I/O CCR Alarm

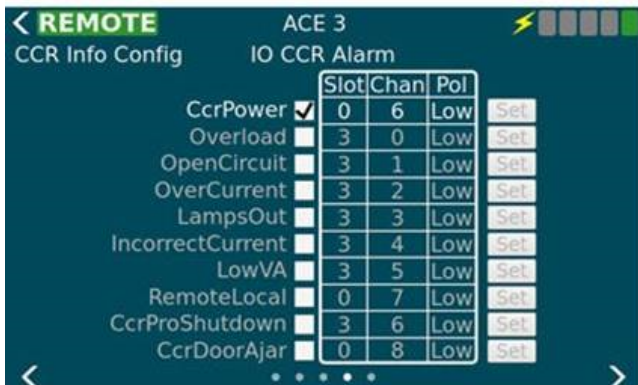

5.1.6.5 Screen 5

The CSS Loops View is used to set the various config parameters for CSS loop setup. This view will only be available if the "Circuit Selector" feature is enabled on the Feature Enable page. It allows the user to configure the following parameters for each loop.

- Enabled - If this loop is installed
- Output Slot - (only in advanced mode) The slot the card occupies in the IO card cage
- Output Channel - (only in advanced mode) The channel on the card to set for this loop
- Output Polarity - (only in advanced mode) Active high or low
- Monitored - Determines if the IO line is monitored which enables the input config parameters below
- Input Slot - (only in advanced mode) The slot the card occupies in the IO card cage
- Input Channel - (only in advanced mode) The channel on the card to set for this loop
- Input Polarity - (only in advanced mode) Active high or low (default high)

None of the changes will take effect until the "Set" button has been pressed.

Figure 28: CSS Loops

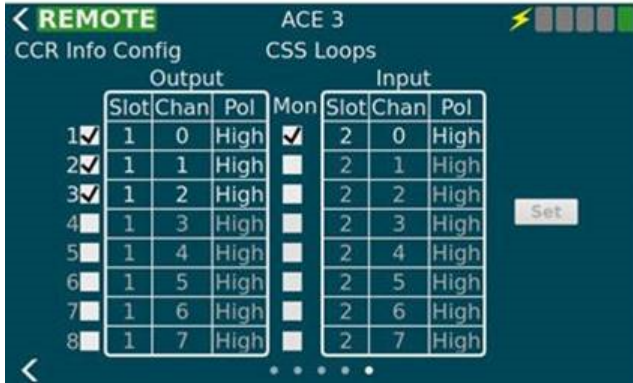

Note
Enabled output slots must be consecutive.

Note
These values are read only if the "cssAdvancedConfig" is absent (default) or set to false in the ace.ini file. If the "cssAdvancedConfig" is set to true then the **slot, channel, polarity**.
A current clamp and True RMS multimeter are required to perform this calibration.

5.1.7 CCR Menu – Measurement Calibration

The Calibration screen is used to calibrate the Output Voltage, Output Current, Input Voltage, and Input Current. The calibrate button at the bottom becomes active when one or more complete units of calibration values have been filled in.

Figure 29: Calibration Screen

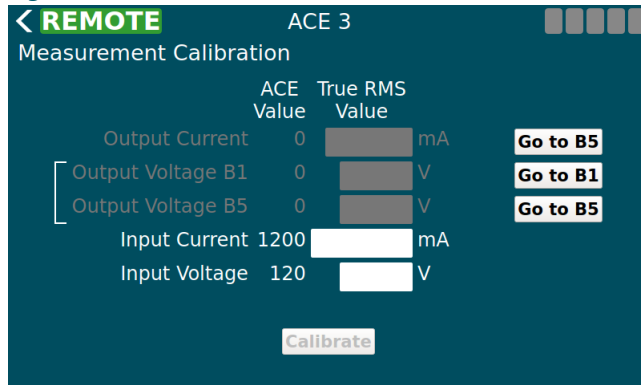

You will need a True RMS Multimeter and a current clamp.

1. Ensure the CCR switch is in Remote.
2. On the ACE3 screen, select **Go to B5**.
3. Select **Override Control**. (see Figure 30)
4. Using your True RMS multimeter and test leads, measure the input voltage of the CCR and input the value in the **Input Voltage** box.
5. Using your True RMS multimeter and current clamp, measure the input current of the CCR and input the value in the **Input Current** box.
6. Using your True RMS multimeter and current clamp, measure the output current of the CCR and input the value in the **Output Current** box.
7. After a calibration value has been entered a red "X" appears next to it allowing the user to reset that value if they want to calibrate again.
8. Select **Calibrate**.

Figure 30: Calibration Screen Override

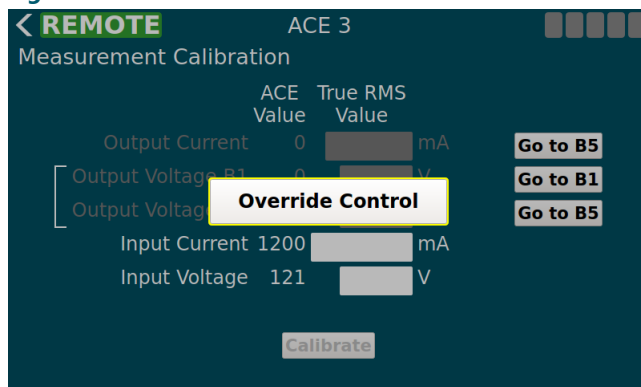

The ACE Value column displays the currently reported value until the True RMS Value column has been filled in. The ACE Value column will then stop updating until the calibrate button is 'pressed' or the value is reset with the red "X".

Figure 31: Calibration Screen with the red X shown

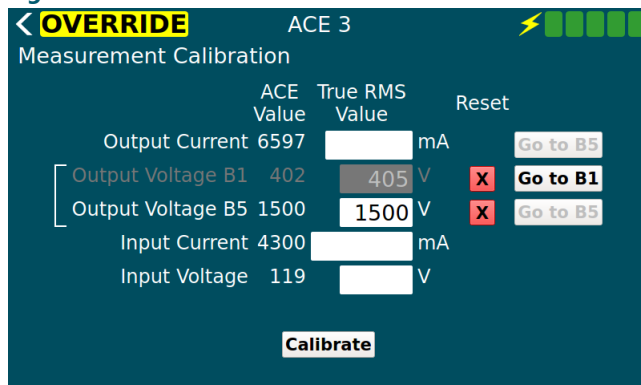

5.1.8 CCR Menu – VA Calibration

The first page of the Output VA Calibration provides a box to adjust the settling time for each step that the ACE3 will wait before taking readings. This will allow any circuit noise that occurs during step change to settle before measuring.

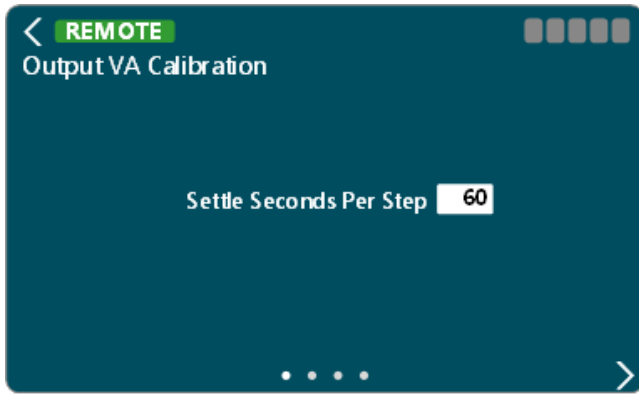

Once the value has been set, select the  button to move to the next page

The second page is where the calibration can begin. Be aware that the CCR will energize and cycle through all available steps.

Press **Start Calibration** to begin

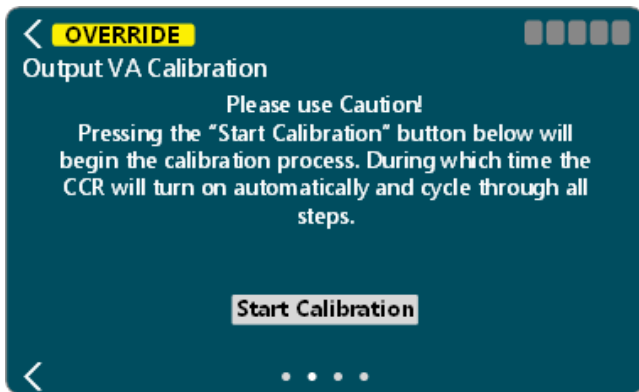

During calibration, the user will be given the ability to cancel the calibration operation, if necessary.

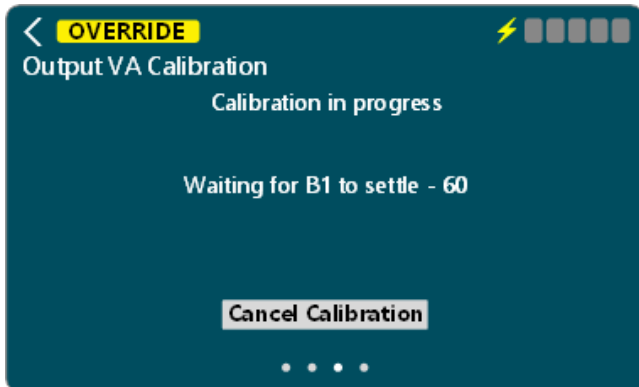

Once the calibration has completed the measurements at all steps, it will give you the ability to **Accept Results** or **Reject Results**.

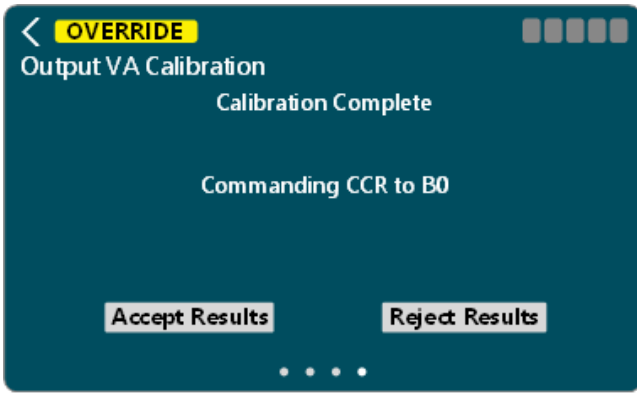

Once the results have been accepted or rejected, the calibration will complete.

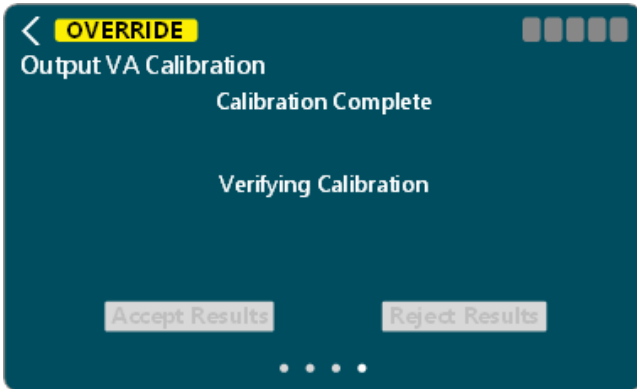

Select the  to return to the main screen

5.1.9 CCR Menu – IRMS Configuration

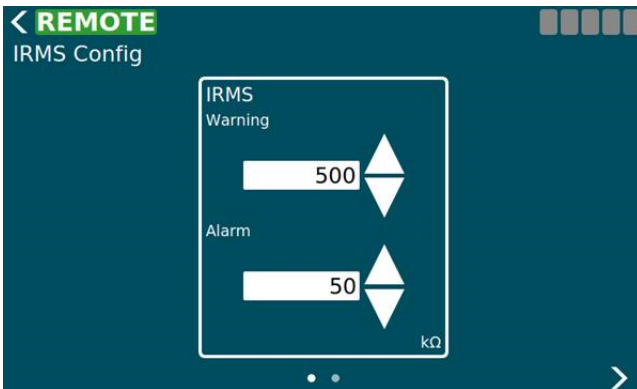

The IRMS config page allows the user to configure thresholds for IRMS alarms and warning as well as set two megging schedules.

The controls on the thresholds page allow the user to either increment or decrement the alarm/warning thresholds by one Kilo-ohm using the up/down arrows or the user can touch the value bringing up a num pad. From there they can select any value within the allowable range. Note that the alarm value must be lower than or the same as the warning.

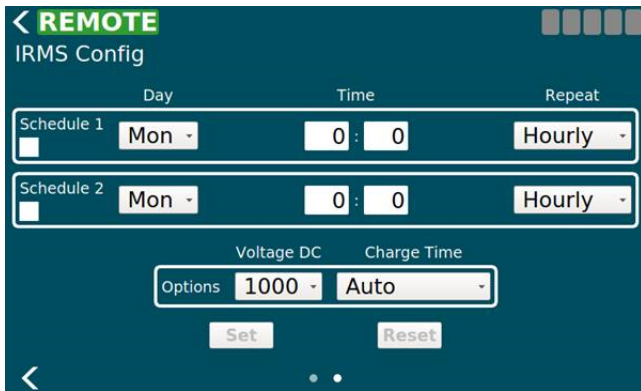

The controls on the scheduling page allow the user to setup the initial delay and the reoccurring interval as well as some additional options.

- Enable checkbox: This is used to enable and disable each IRMS schedule independently.
- Day: This is the day of this week to start the schedule. If the day is in the past then a meg will start immediately and then run again once the next reoccurring period has passed.
- Hour & Minute: The hour and minute for the initial delay. If the time is in the past then a meg will start immediately and then run again once the next reoccurring period has passed.
- Repeat: This is the repeat interval to run the meg after the initial delay has passed. Possible values are listed in the IRMS Schedule Repeat Table.
- Voltage: This is the maximum voltage the IRMS test will attempt to run at. Depending on the quality of the circuit the max may never be reached. This voltage is used for both megging schedules. Possible values are listed in the IRMS Schedule Voltage Table. Values may be set to 50, 500, or 1000 volts.
- Charge Time: The charge time is how long to charge the IRMS equipment to the desired max voltage before starting the test. Possible values are listed in the IRMS Schedule Charge Table. Note: The continuous option is not available due to a design decision.

Once the user has modified a field it will no longer be updated with changes until the user presses "Set" or "Reset". The "Set" button sends all currently displayed values while the "Reset" button removes any modifications the user has made and will refresh everything with what is currently reported.

Megging Immediately

To start a meg immediately, return to the ACE3 main screen. Press the ellipsis icon in the IRMS window.

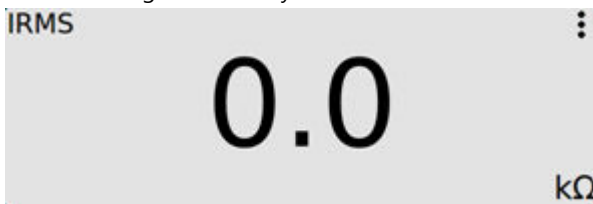

1. Click the green arrow to start a meg check. (active if no meg is in progress) (greyed out during a meg in process). A yellow Ω icon will appear at the top of the ACE3 screen while megging is in progress.
2. Click the red box to stop the meg check. (active if a meg is in progress) (greyed out if no meg is in process)



5.1.10 CCR Menu – Lamps Out Calibration

The first view allows the user to set the lamps out thresholds before a warning and/or alarm is generated. Setting these to 0 turns the alarm and warning off. The warning value can never be greater than the alarm. The numpad or the increment/decrement arrows can both be used to change the value(s). Changes to the screen take effect immediately.

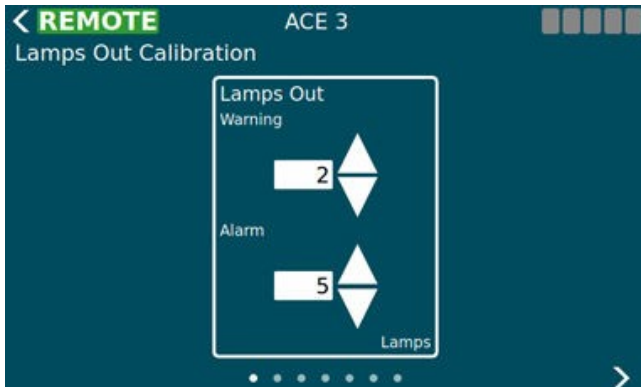

The remaining views act as a wizard. The first three views can be navigated by the user however if the user wishes to start an actual calibration then they must have control of the ACE 3 and they no longer have the ability to navigate through the wizard. They will be allowed to cancel the calibration at any time which will take them back to the first view.

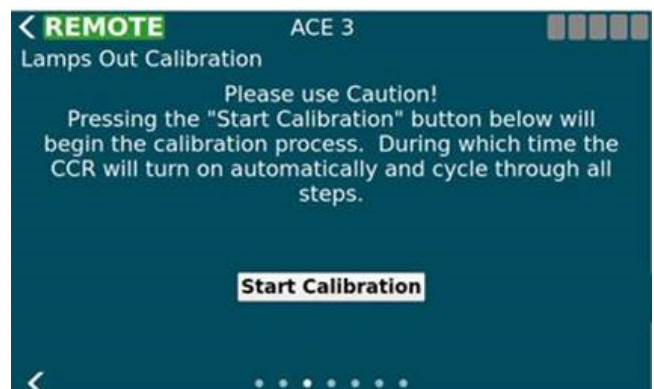
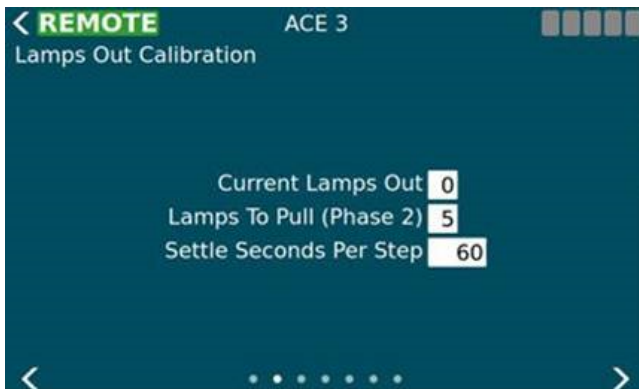

The calibration consists of two phases. The first is calibrating the existing circuit. The second is pulling a set number of lamps and calibrating again.

After calibration is complete the user can accept the results or reject them. Accepting saves the results to the ACE 3 and they will be used going forward.

Once the calibration has started, the ACE3 will command the CCR on to each brightness step, taking measurements at each step, for the duration of the configured settle time per step.

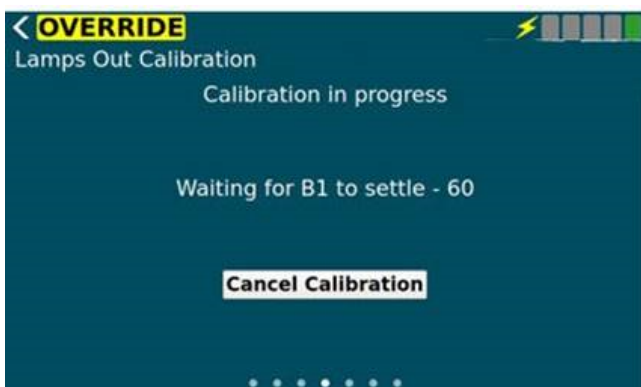

After the initial measurement phase, the user will need to pull the appropriate number of lamps*.

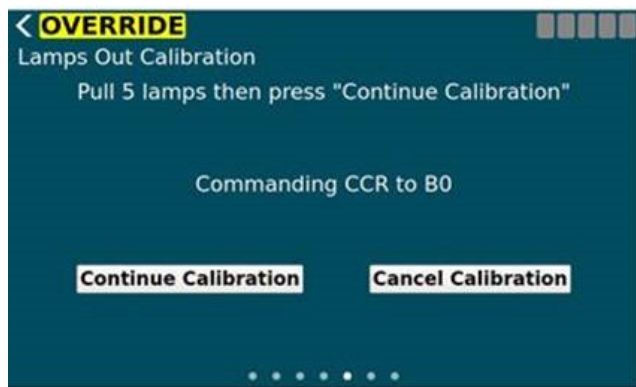

 **CAUTION**
*Make sure the CCR is De-Energized

Press **Continue Calibration** after the lamps have been pulled.

Once the calibration continues, the ACE3 will command the CCR on to each brightness step, taking measurements at each step, for the duration of the configured settle time per step.

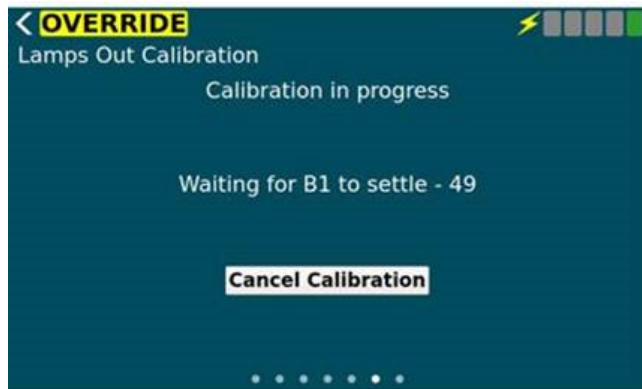

Once the calibration has completed the measurements at all steps, it will give you the ability to **Accept Results** or **Reject Results**.

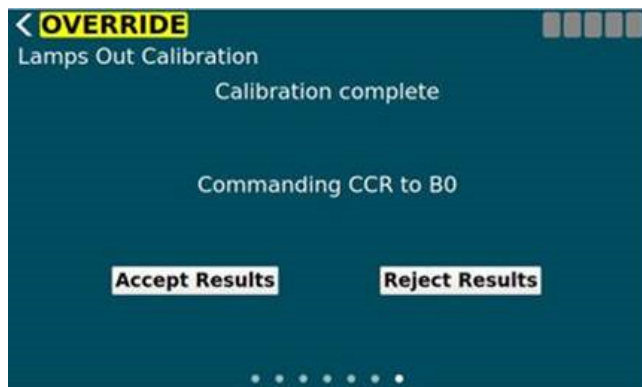

Once the results have been accepted or rejected. The calibration will complete.

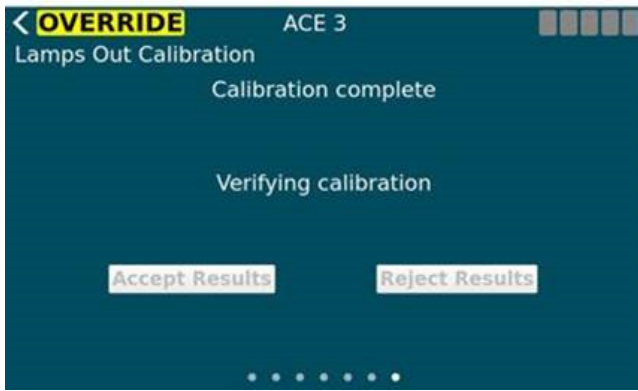

Select the  to return to the main screen

5.1.11 ACE Menu - Configuration

The ACE Info Config screen has a set of views which allow the user to configure various parameters of the ACE 3. The first view is a set of miscellaneous items which setup the ACE 3.

- Name - The name of the ACE 3. This will be displayed in the header bar.
- Mode - This determines how the ACE 3 is setup. Is it connected to a CCR or is it IO only, etc...
- Port A (enabled, Baud, Address) - A checkbox to enable or disable port A (legacy ACE protocol), the baud rate, and the multi-drop address. This is only used when in ALCS mode.
- Port B (enabled, Baud, Address) - A checkbox to enable or disable port B (legacy ACE protocol), the baud rate, and the multi-drop address. This is only used when in ALCS mode.



The second view allows the user to set the date and time. The date and time are set in UTC time. The user can also see the current date/time on the ACE 3. To enable NTP (Network Time Protocol) the user can check the box at the bottom of the view and specify a NTP server. The ACE 3 will then use NTP to get its time from that point on. Unchecking the box turns off the use of NTP.



The network configuration views allow the user to configure both the LAN interfaces as well as the wireless interface.

The third view allows the user to configure the two local area network (LAN) connections. Once the user has made all desired modifications they can press the "Set" button to **store** the new configuration or the "Reset" button to **erase** all local changes and use the existing configuration.

Figure 32: ACE Info Config Screen (network Config)

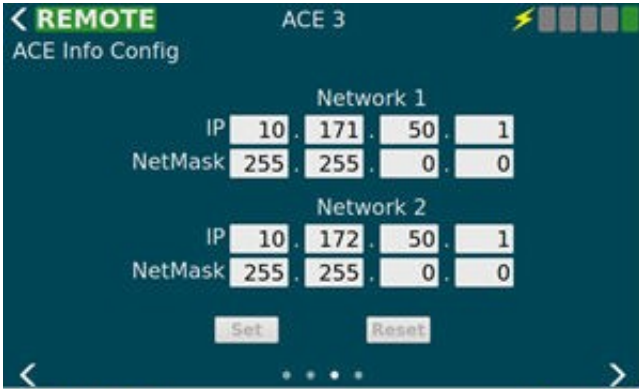

The fourth view allows the user to configure the Wireless connection located on the ACE 3. To use the WIFI interface the user must select the "Enable WIFI" checkbox at the top of the view. The network security will always be WPA2-Personal and cannot be changed from the GUI. The user can browse the broadcast SSID's and choose one by pressing the left arrow button or type in a hidden SSID directly in the "SSID" text area. The passphrase text area allows the user to type in their password. If they wish to see what they have typed they can check the "Show Passphrase" checkbox on the left hand side of the screen.

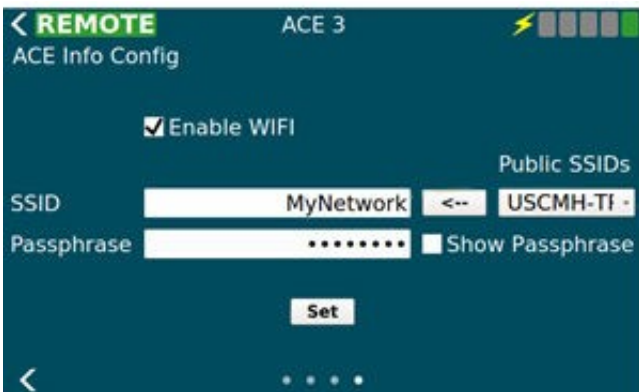

5.1.12 ACE Menu – Failsafe

The Failsafe Config screen is used to setup how the ACE 3 handles failsafe conditions. It determines when entering failsafe how the step, loops, and output cards should be set. Output Card is populated only when there are cards detected.

Figure 33: Failsafe Config Screen

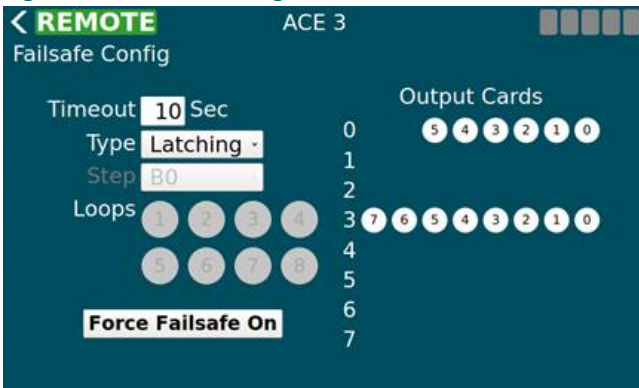

The button at the bottom can force failsafe on and off even if the ACE 3 is not in a failsafe situation.

The fail-safe mode of each ACE3 unit is defined per requirements of the airport/owner. The fail-safe modes are as follows:

- **Latching Fail-safe Mode:**

This mode is executed as follows:

- If the CCR was switched ON before the failure, it will remain ON at the same brightness level.
- If the CCR was switched OFF before the failure, it will remain OFF.

- **Simple Fail-safe Mode:**

This mode is executed as follows:

- After a failure occurs, the CCR will switch ON to a predetermined brightness level without regard to the current step.

- **Smart Fail-safe Mode:**

This mode is executed as follows:

- If the CCR was switched ON before the failure, it will remain ON at the same brightness level.
- If the CCR was switched OFF before the failure, it will switch ON to a predetermined brightness level.

5.1.13 ACE Menu – Feature Enable

The Feature Enable screen is used to enable or disable features, alarms, and warnings one at a time by checking the box next to the feature/alarm/warning name. These changes take effect immediately and are stored.

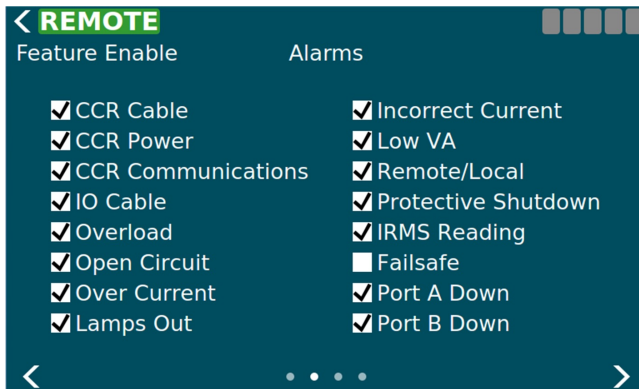

Disabling an alarm or warning prevents that alarm/warning from showing up on the alarm page and the corresponding event(s) will not be generated.

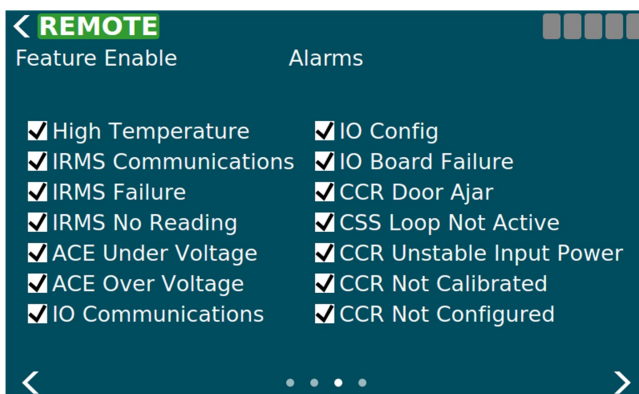

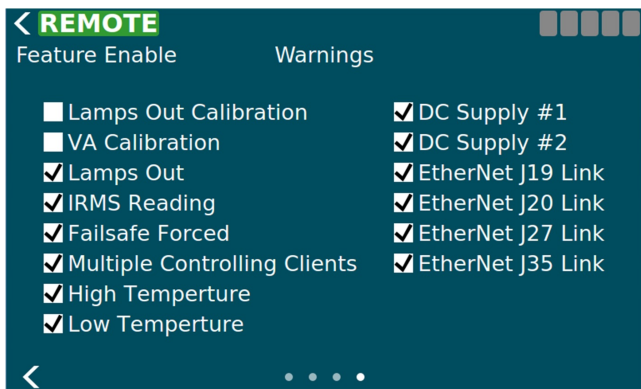

5.1.14 ACE Menu – About

The first view on the About screen displays the serial number and version info of installed modules. Using three fingers and swiping up will add a column next to the version info to display the build number for trouble shooting purposes.

Figure 34: About Screen

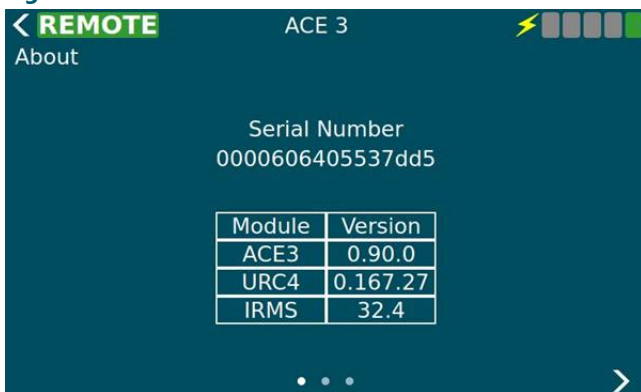

The second view is a collection of buttons which do system maintenance activities. On this view the user can upgrade the software from a USB device, restart the ACE 3 software only, restart the entries ACE 3 device, backup the ACE 3 (config, calibration data, logs, database) to a USB device, restore the ACE 3 (config, calibration data, logs, database) from a USB device.

Figure 35: About Screen Menu



The third view shows any licensing info such as the LGPL license and any other related info. This information comes from a text file so it can be customized by the legal department. There is no limit on the length of the text since this view's contents are scrollable.

Figure 36: About Screen Disclaimer

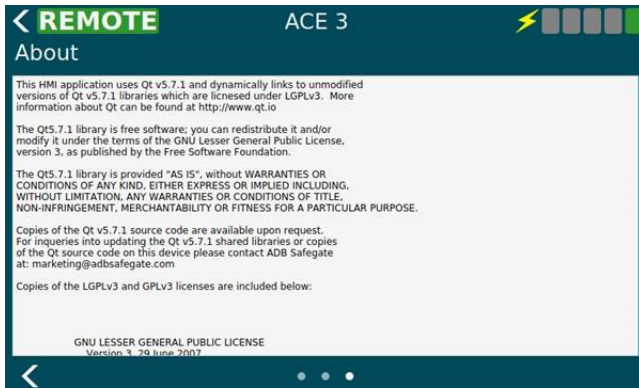

6.0 CCR Maintenance

This section provides preventive maintenance for Thyristor Controlled L-828/L-829 constant current regulators (CCRs) (4-30 kW).

6.1 Maintenance Safety

DANGER

Electric Shock Hazard

This equipment may contain electrostatic devices

- Do not operate a system that contains malfunctioning components. If a component malfunctions, turn the system OFF immediately.
- Disconnect and lock out electrical power.
- Allow only qualified personnel to make repairs. Repair or replace the malfunctioning component according to instructions provided in its manual.



Failure to follow these instructions can result in death or equipment damage

6.2 Maintenance Schedule

To keep the L-828/L-829 CCRs operating efficiently, follow a preventive maintenance schedule. Refer to [Table 17](#).

Table 17: L-828/L-829 CCR (4-30 kW) Maintenance

Interval	Maintenance Task	Action
Daily	Check all control equipment for proper operation.	Check local and remote control (if used) on each brightness step.
Monthly	Check input voltage.	If input voltage is not within -5% to +10% of the nominal value specified on the nameplate of the regulator, notify power company to correct voltage.
	Check and record output current on each brightness step.	Use a true rms-reading instrument. Adjust current levels if out of tolerance. Refer to Adjustment Procedures in the CCR Operation section. Refer to Table 8 for the current range for the 3-Step and 5Step CCRs.
Annually	Check relays, wiring and insulation.	Clean dirty or slightly pitted contactor contacts. Use a fine file for surface cleaning. Replace contacts that are excessively burned or pitted. Operate the local control switch to check for proper operation of relays and contactors. Make sure input and output connections are tight and that no damaged wires or damaged insulation exists.
	Inspect housing for rust spots.	Clean and touch-up rust spots with paint.
	Inspect lightning arrestor connections.	Tighten any loose connections. Replace charred or burnt wiring or broken arrestors.
	Perform a short-circuit test.	Refer to Short-Circuit Test in this section.
	Perform an open-circuit test.	Refer to Open-Circuit Test in this section.
Unscheduled	Check load on regulator.	At installation and subsequent load changes make sure that the output RMS voltage times the output true RMS current does not exceed the rated load on the nameplate of the regulator.

6.2.1 Short-Circuit Test



WARNING

Since high open-circuit voltages may result by opening the primary of a series lighting circuit, only personnel authorized to work on high-voltage equipment should be allowed to perform the short-circuit test.

To perform the short-circuit test, perform the following procedure:

1. Remove input power to the regulator (turn off disconnect switch or main circuit breaker) and turn the rotary switch to OFF.
 2. Remove leads from output terminals and bushings. Use AWG 8 or larger wire to short output bushings.
 3. Energize the regulator and turn the rotary selector switch to the lowest brightness step (B1 or B30) and then to the remaining brightness steps. Check the output current on the ammeter at each step.
-



Note

The output current should be within the tolerance given in [Table 8](#). The panel meter is intended to indicate function. Any calibrations should be performed with a calibrated true RMS current meter.

If the output current is not within the limits specified in [Table 8](#) check the input voltage to the regulator. The supply voltage should be within -5% to +10% of the nominal input voltage given on the regulator nameplate. Refer to Adjustment Procedures in the Operation section.

1. Turn off disconnect switch or main circuit breaker to remove input power to regulator.
 2. Disconnect the shorting jumper and reconnect output cables.
 3. Close input-power disconnect switch or main circuit breaker.
-

6.2.2 Open-Circuit Test



WARNING

Since high open-circuit voltages may result by opening the primary of a series lighting circuit, only personnel authorized to work on high-voltage equipment should be allowed to perform the open-circuit test.

To perform the open-circuit test, perform the following procedure:

1. Remove input power to regulator (turn off disconnect switch or main circuit breaker) and turn the rotary switch to OFF.
 2. Disconnect cables from the output terminals and bushings.
 3. Turn on input power to the regulator.
 4. Turn the rotary switch to the lowest brightness position (B1 or B30). The open-circuit protective device should automatically de-energize the regulator in less than 2 seconds.
 5. Turn the rotary switch to OFF. The open-circuit protective device should reset.
 6. Turn the rotary switch to position B1 or B30. The regulator should turn on and then de-energize in less than 2 seconds.
 7. If regulator operation is satisfactory, turn rotary switch to OFF, and turn off disconnect switch or main circuit breaker before reconnecting the load.
 8. After the load has been reconnected, turn on input power to the regulator.
-

6.3 DA00019-THY-01 Schematics

Figure 37: DA00019-THY-01 Schematic

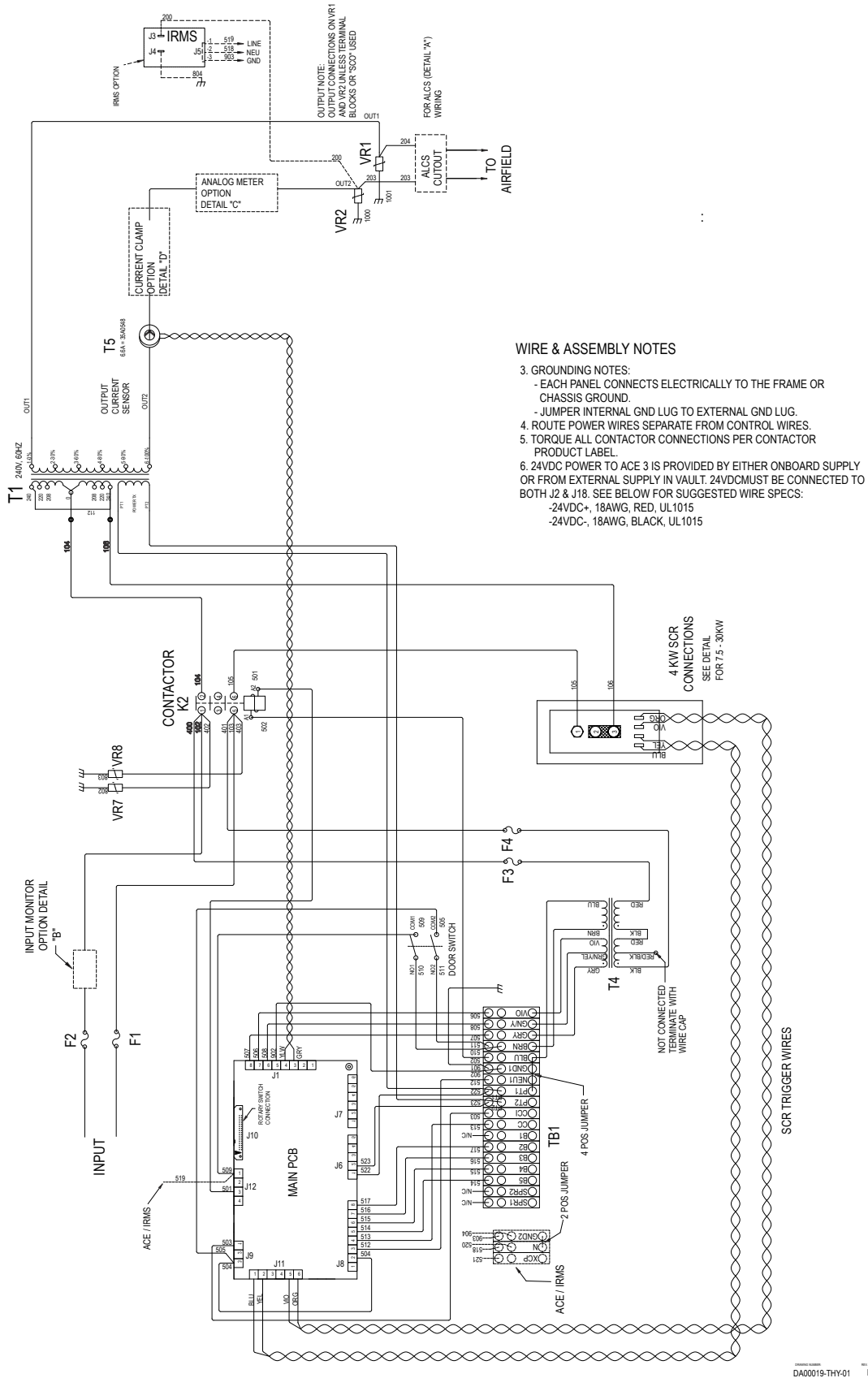

Figure 38: DA00019-THY-01 Schematic T4 Connections

T4 "THYRISTOR" WIRING CONNECTIONS

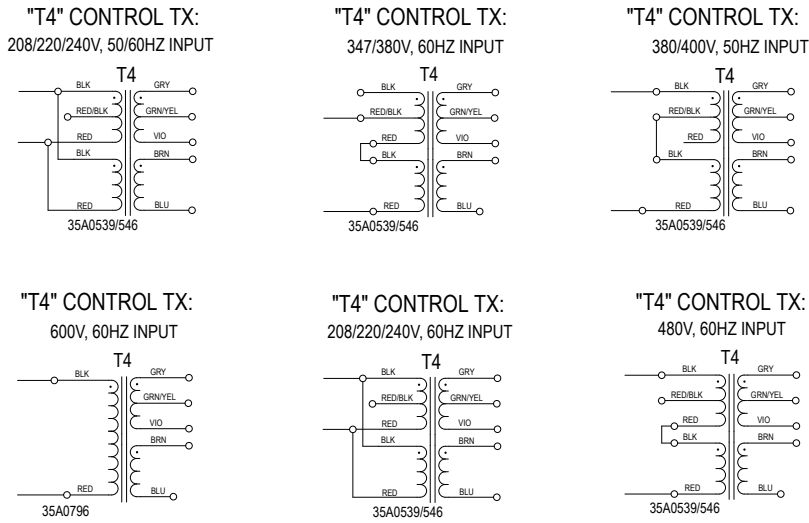

Figure 39: DA00019-THY-01 Schematic T1 Voltages

T1 "THYRISTOR" WIRING CONNECTIONS

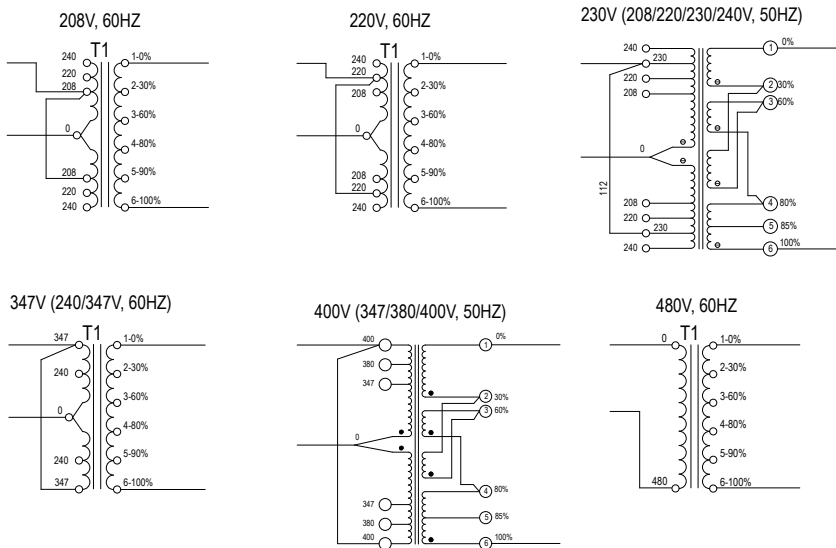
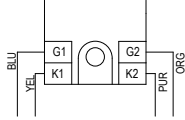

Figure 40: DA00019-THY-01 Schematic SCR Connections

SCR "THYRISTOR"
WIRING CONNECTIONS

7.5KW, SCR 28A0039,
208-480V (NO GND WIRE)



10KW, SCR 28A0038,
208-480V (NO GND WIRE)

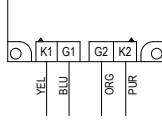

15KW, SCR 28A0034,
208-480V (NO GND WIRE)

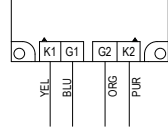

20 & 30KW, SCR 28A0041,
(ALSO 28A0028),
208-480V (NO GND WIRE)

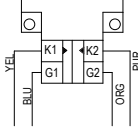

Figure 41: DA00019-THY-01 Schematic PCB Layout

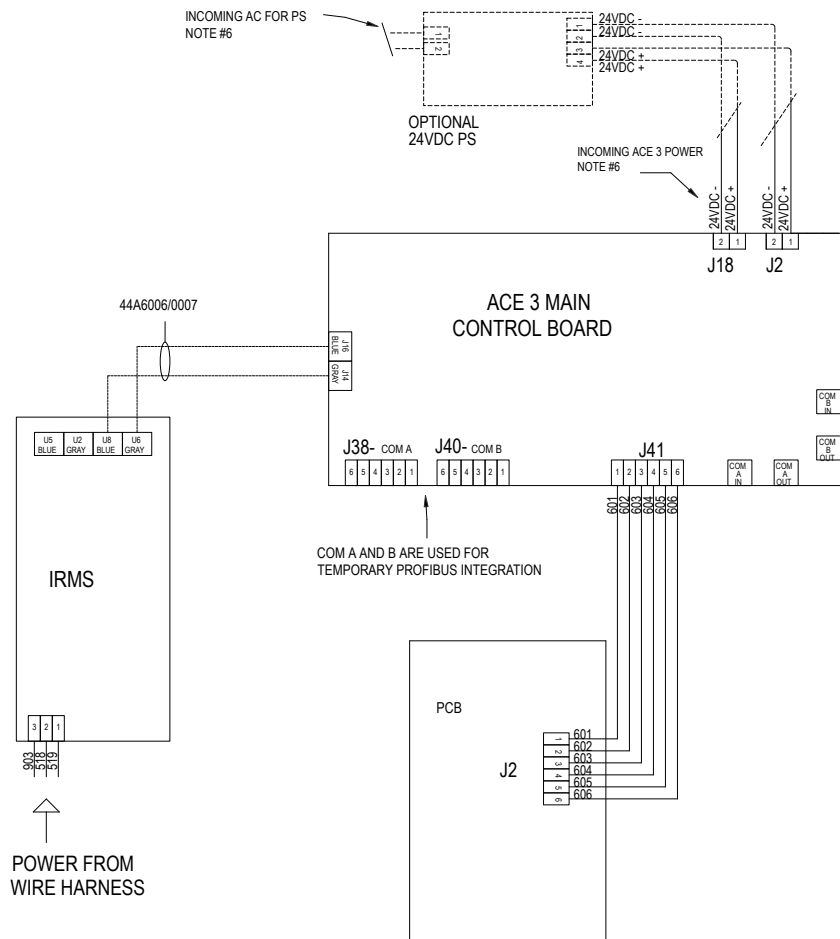
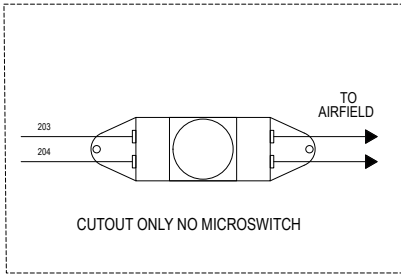
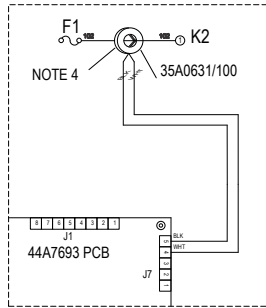

Figure 42: DA00019-THY-01 Schematic Details

**DETAIL "A"
 ALCS OPTION**



**DETAIL "B"
 INPUT MONITOR OPTION**



**DETAIL "C"
 ANALOG METER OPTION (6.6A)**

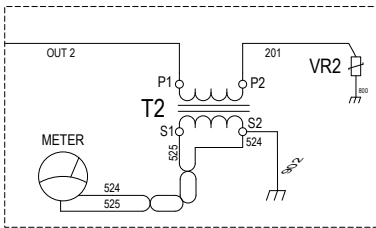

**DETAIL "D"
 CURRENT CLAMP OPTION**

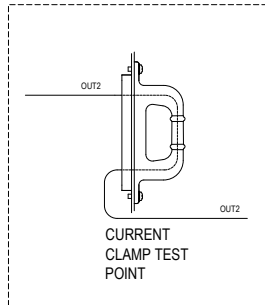

7.0 Troubleshooting



WARNING

Allow only qualified personnel to perform the following tasks. Observe and follow the safety instructions in this document and all other related documentation.

- De-energize regulator by turning rotary switch S1 to OFF, and remove input power to regulator by turning off disconnect switch or main circuit breaker. Discharge capacitors and ground output terminals bushings by using a grounding rod prior to touching any parts.
- If the regulator de-energizes, the output circuit could be interrupted by an overcurrent, open-circuit, or under-voltage condition. Before inspecting the output circuit, place rotary selector switch S1 in the OFF position and turn off disconnect switch or main circuit breaker. Without this precaution, a dip in the power line may reset the regulator and turn it on, resulting in an output voltage of thousands of volts which can cause serious injury or death.
- Contents are static-sensitive. Must be grounded when handling PCB.



CAUTION

Short the output terminals before switching the regulator on. The wire should be AWG 8 or larger.

7.1 Introduction

This section provides a preliminary troubleshooting check list and troubleshooting procedures for the Thyristor Controlled L-828/L-829 CCR (4-30 kW):

7.2 Preliminary Troubleshooting

The following is a check list of initial steps to perform.

- Visually examine all areas of the CCR. Do burnt or loose connections/parts exist?
- Is the input voltage present and within -5 to +10% of nominal?
- Check all the fuses.
- Are the wire harness connectors to the control board fully seated?
- Have the PCBs been adjusted in accordance with the instruction manual?
- If the CCR works in local but not Remote, check the voltage on the Remote control lines.
- Can the CCR be re-energized by turning the rotary switch from OFF to Step B1 (B10)?
- Short the output of the CCR with an AWG 8 wire, and turn on the CCR. If the regulator operates normally, the problem is probably load related.
- If the CCR turns on and then shuts off after a few seconds and the ammeter has a high current reading, the problem is overcurrent. Adjust the output current accordingly. If the output current is not adjustable, replace the control board restart the regulator.
- If the CCR still fails in overcurrent, replace the SCR and restart.

7.3 Troubleshooting Failed Components

This subsection provides information for troubleshooting fuses and other components.

7.3.1 L-828 General Troubleshooting

This subsection provides general troubleshooting procedures for the L-828 CCR.



WARNING

Read the instructions in their entirety before starting installation.

Only personnel authorized to work on high-voltage equipment should perform maintenance on the regulator.

Since high open-circuit voltages may result by opening the primary of a series lighting circuit, only personnel authorized to work on high-voltage equipment should be allowed to perform the open-circuit test.

Operating a regulator for long periods of time while seriously overloaded may cause the regulator to overheat.

Table 18: General Troubleshooting

Problem	Possible Cause	Corrective Action
1. Regulator not turning on	Main power supply off	Verify presence of input voltage.
	Switched off due to overcurrent	Switch regulator off in local. Wait for 2 seconds and check to see if the regulator now operates correctly.
	Incorrect external wiring	If the regulator works correctly in local but not in Remote, check the Remote control signals.
	Blown fuse	Replace any blown fuse. Check the input supply voltage and make sure that it is between -5% and +10% of the nominal value listed on the CCR nameplate.
2. Regulator turns on but de-energizes suddenly	Defective PCB	Replace PCB.
	Output circuit interrupted	Apply a short to the regulator output. Turn the regulator on. If the regulator works correctly, repair the lighting circuit. Follow all safety precautions in this manual.
	Defective printed circuit board	Replace regulator controller.
	Overcurrent condition	Check SCRs and wiring. Replace SCR.
3. Output Current always 6.6 A	CCR controller not calibrated	Refer to "Output Current Adjustment" Check remaining steps to verify the values from Table 8 .
	Overcurrent condition	Refer to problem #2 in this table, <i>Regulator turns on but de-energizes suddenly</i> .
4. Output Current always 4.8 A or less for 3-Step CCR or 2.8 A or less for 5-Step CCR	Defective control board	If problem exists in Remote and local control, replace CCR controller.
	SCRs always conducting	Verify SCR is triggering by replacing PCB. Check SCRs and wiring for shorts in SCR circuitry. Replace SCR.
	CCR overload	Remove section of load.
5. More than 2 seconds required for CCR to de-energize on open-circuit load	Faulty overcurrent protection	Replace CCR Controller PCB.

Table 18: General Troubleshooting (Continued)

Problem	Possible Cause	Corrective Action
6. Short lamp life and/or high output current reading on panel ammeter	Incorrect output current adjustment Faulty overcurrent protection	Refer to "Output Current Adjustment" . Replace CCR Controller PCB.
	Incorrect output current adjustment	Refer to "Output Current Adjustment" . Refer to Problem #10 in this table.
7. Regulator not indicating proper current	Current meter not calibrated or faulty	Turn the regulator to the top step (6.6 A/20 A). Verify the current with a true-rms current meter. If the meter is not accurate, adjust the meter with the screw on the front cover. For systems equipped with ACE, refer to: <ul style="list-style-type: none"> • Advanced Control Equipment (ACE1) manual 96A0287 or • Advanced Control Equipment (ACE3) manual 96A0357 for display calibration procedures.
	The rotary switch on the input module not set to REM	Set the rotary switch to REM.
8. Regulator operates by the local control switch but not by Remote control	Blown fuse	Check fuse F5.
	Loose or broken Remote control wires	Check connections on Remote terminal block TB1. If 120 Vac Remote control signals are used, use an AC voltmeter (300 Vac scale) to verify correct signals are received at the CCR.
	Incorrect wire connections	Refer to schematics .
9. Ammeter on CCR oscillates and loud noise occurs	SCR drive not working properly	Check connections at SCR module. Replace CCR Control PCB. Verify that the CCR transformer output taps are not set too low for the desired output. Refer to schematics .
10. Output current not able to be adjusted up to 6.6 A/20 A	Regulator load too large	Either reduce the load or replace the regulator with a larger kW CCR. When overloaded, the regulator may make a faint bouncing sound as the controller bounces against the upper control limits.
		 Note This problem can also be verified by shorting the output of the CCR and verifying output current can be adjusted correctly in each step.

7.4 Additional L-829 General Troubleshooting Procedures

For additional L-829 CCR general troubleshooting procedures, refer to the Troubleshooting section in manuals:

- 96A0287, Advanced Control Equipment (ACE™) or
- 96A0357, Advanced Control Equipment (ACE3™).

7.5 Component Replacement Procedures

Replacement procedures for several various components.

7.5.1 Removing and Replacing URC4 Regulator Control PCB



CAUTION

It is very important to match the configuration for regulator type and regulator class when replacing the URC4. Take a picture and write down the switch positions of the URC4 prior to starting this procedure.

1. Turn CCR local switch to the OFF position.
2. Remove and "lock out/tag out" primary power to the CCR at the breaker panel.
3. Lock out/tag out the SCO in the maintenance position.
4. Loosen the door latch screws and open the CCR door.
5. Unplug all connectors from the PCB.
6. Disconnect the ribbon cable from J10 by pressing out on the tabs at both sides of the ribbon connection and pull the cable away from the board.
7. Remove the 4 screws at the 4 corners of the PCB. Retain the standoffs.

Figure 43: PCB URC4 Regulator Control (44A7693)

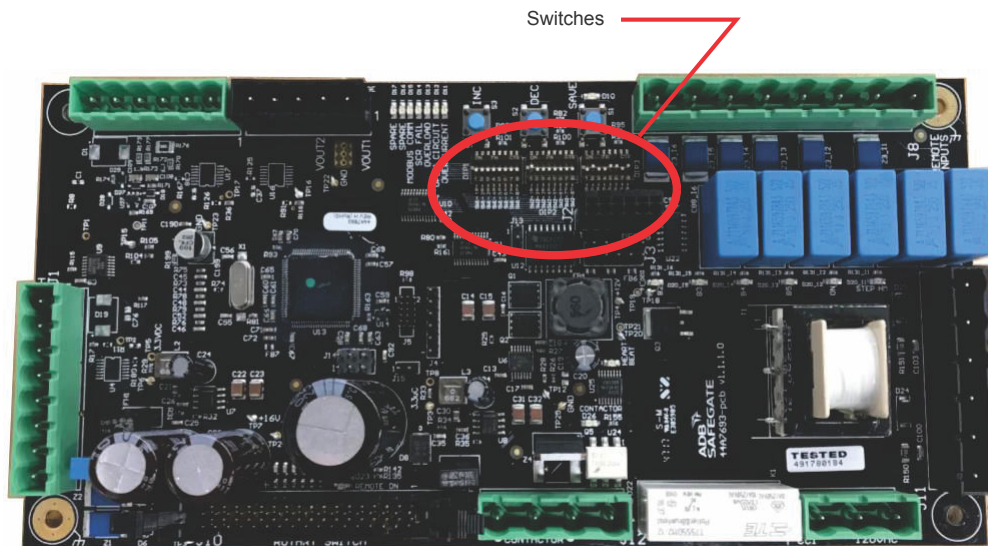

8. Ensure that the DIP switches of the new board match exactly to those of the board being replaced.
9. Mount the new PCB by replacing the 4 screws and the standoffs at the corners of the PCB.
10. Plug the ribbon cable back into J10 by pressing it in.
It is keyed and will only go in one way. Also verify the tabs on the side have locked into place.
11. Plug in all of the connectors disconnected in step 5 to the PCB.
12. Close the CCR door and tighten the door latch screws.
13. Restore the SCO to the ON position.

14. Restore primary power to the CCR at the breaker panel.

15. Turn the CCR local switch to the REM position.

Figure 44: Switch Bank 1

1	1	Factory Reset OFF = Normal Operation ON = Load Default Configuration
	2	Style (3/5 step) OFF = 5 step ON = 3 step
	3	<div style="background-color: yellow; text-align: center; padding: 2px;">CAUTION</div> Disconnect any load and short the output of the regulator before testing with this DIP switch enabled. Calibration Mode (105% OC) (Default to OFF)
	4	<div style="background-color: yellow; text-align: center; padding: 2px;">CAUTION</div> Disconnect any load and short the output of the regulator before testing with this DIP switch enabled. Calibration Mode (125% OC) (Default to OFF)
	5	Start Mode OFF = Hard start ON = Soft start Hard start injects around 2.8A of current into the field circuit upon regulator activation before moving to the set step. This is done to synchronize flashing loads such as runway guard lights. Note: When URC4 is setup for 20 amp mode the CCR will always operate is "soft start". So the position of the dip switch which selects hard/soft start (default hard) is ignored.
	6	URC4 Input Power Door Switch OFF = No URC4 input power door switch ON = URC4 input power door switch installed
	7	Reserved (Default to OFF)
	8	Slow PID OFF = Not enabled

Figure 45: Switch Bank 2

Bank	Position	Purpose	
2	1	CAUTION	
		It is very important when replacing the URC4 to match the Regulator type.	
			Regulator Type
			123
	2		Ferro
			Thyristor
			SynchroThyristor
			Synchro-Tap
			000
			100
			010
			110
	3		Reserved
			Reserved
			Reserved
			Reserved
		001	
		101	
		011	
		111	
4		Reserved (Default to OFF)	
5		Reserved (Default to OFF)	
6		CAUTION	
		It is very important when replacing the URC4 to match the Class type.	
			Class (6.6 / 20 amp)
			OFF = 6.6 amp
		ON = 20 amp	
7		Output Voltage Sensing	
		OFF = Core Winding	
		ON = External Transformer	
8		Reserved for Manufacturer (Default to OFF)	

Figure 46: Switch Bank 3

Bank	Position	Purpose		
3	1	Input Volts	1234	
		120 VAC	0000	
	2	208 VAC	1000	
		220 VAC	0100	
		230 VAC	1100	
	3	240 VAC	0010	
		347 VAC	1010	
		380 VAC	0110	
	4	400 VAC	1110	
		480 VAC	0001	
		600 VAC	1001	
	5	5	Output Power	5678
			200 Watts	0000
		6	1 KW	1000
			2 KW	0100
			3 KW	1100
		7	4 KW	0010
			5 KW	1010
			8 KW	0110
		8	10 KW	1110
			15 KW	0001
			20 KW	1001
			25 KW	0101
				30 KW

7.5.2 CCR Contactor Replacement

To Provide users with the steps necessary to replace the CCR contactor and connect the wires.



WARNING

Electrical Shock

Read installation instructions in their entirety before starting installation.

- Become familiar with the general safety instructions in this section of the manual before installing, operating, maintaining or repairing this equipment.
- Read and carefully follow the instructions throughout this manual for performing specific tasks and working with specific equipment.
- Follow all applicable safety procedures required by your company, industry standards and government or other regulatory agencies.
- Protect components from damage, wear, and harsh environment conditions.
- Protect equipment with safety devices as specified by applicable safety regulations.
- If safety devices must be removed for installation, install them immediately after the work is completed and check them for proper functioning prior to returning power to the circuit.

Failure to follow these warnings may result in serious injury or equipment damage.

1. Turn CCR local switch to the OFF position.

diagram or picture here

2. Label the wires.
3. Remove and lock out/tag out primary power to the CCR at the breaker panel.
4. Lock out/tag out the SCO in the maintenance position.
5. Open the CCR front door by loosening the 3 door screws.
6. Loosen the wire retaining lugs for 102, 103, 104 and 105 and disconnect.
See diagram.
7. Label any wires not labeled prior to disconnecting them.
8. Remove wires 400 and 401 from the top connectors of the contactor.
9. Remove the wires 531 and 501 from the contactor coil connections at the bottom of the contactor.
10. Remove the mounting screws until the contactor is free.
 - a. Remove the mounting adapter (ADBSG# 63A1153) if used. Only used for contactor, part number 53A0412/25.

Figure 47: Mounting Adapter 63A1153

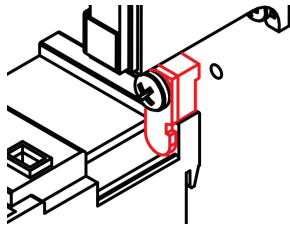

1. **Replace the contactor.**
11. Replace the contactor, except for contactor part number 53A0412/25. See note.
Tighten the contactor retaining screws on the contactor plate.

Note

For a contactor, part number 53A0412/25, which requires replacing, a tapped hole will need to be added because the contactor is mounted with a screw a mounting adapter (ADBSG# 63A1153).

Figure 48: Mounting Adapter 63A1153 Location

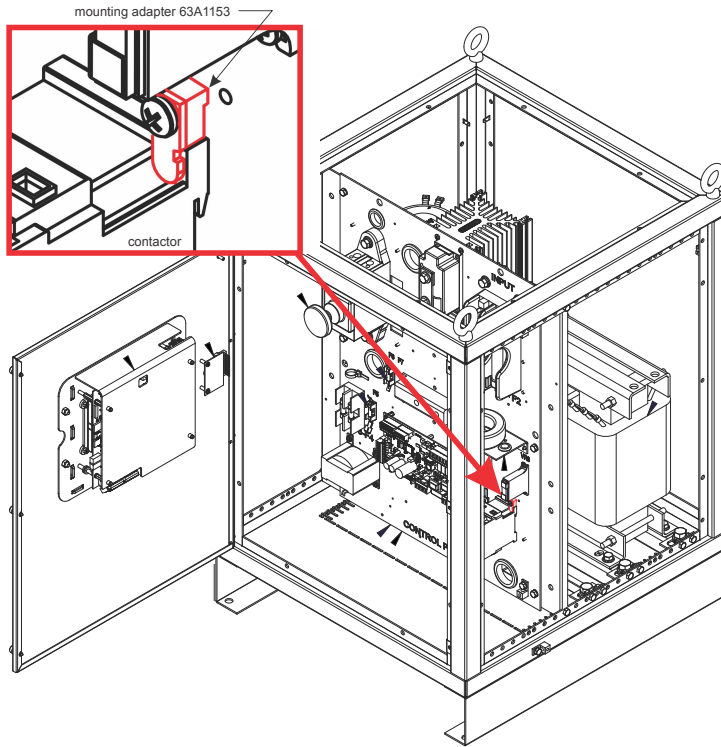

- a. Hold the contactor (fasten) on the component plate so that the top mounting hole aligns on the panel.
 - b. Mark the location for the new 8-32 tapped hole.
 - c. Remove the contactor and drill the hole with #29 drill.
 - d. Tap drilled hole with a 8-32 unc-2b (course thread) tap.
 - e. Replace the contactor and rewire.
12. Connect wires 531 and 501 to the contactor coil connections at the bottom of the contactor.
 13. Connect wires 400 and 401 to the top connectors of the contactor.
 14. Connect the wires for 102, 103, 104 and 105 and tighten retaining lugs.
 15. Close the CCR front door by tightening the 3 door screws.
 16. Restore the SCO to the ON position.
 17. Restore primary power to the CCR at the breaker panel.
 18. Turn the CCR local switch to the REM position.

7.5.3 Removing and Replacing Input Lightning Arrestors (front of Component Mounting Plate)

1. Turn CCR local switch to the OFF position.
2. Remove and lock out/tag out primary power to the CCR at the breaker panel.
3. Lock out/tag out the SCO in the maintenance position.

4. Open the CCR front door by loosening the 3 door screws.
5. Loosen the wire retaining screws for 402, 403, 802 and 803 and disconnect.
See drawing 43A2845.
6. Remove the top two of (4) #10 x 32 pan-head screws and loosen the bottom two screws until the arrestors are free.
7. Replace the Input Lightning Arrestor assembly.
Replace the two top screws on the assembly plate and tighten all four until the arrestors are secure.
8. Connect the wires for 402, 403, 802 and 803 and tighten retaining screws.
9. Close the CCR front door by tightening the 3 door screws.
10. Restore the SCO to the ON position.
11. Restore primary power to the CCR at the breaker panel.
12. Turn the CCR local switch to the REM position.

7.5.4 Removing and Replacing Output Lightning Arrestors

(Located in front of Component Mounting Plate)

1. Turn CCR local switch to the OFF position.
2. Remove and lock out/tag out primary power to the CCR at the breaker panel.
3. Lock out/tag out the SCO in the maintenance position.
4. Remove the side panel of the CCR, by removing the 8 mounting screws.

Be careful as you will also need to disconnect the ground wire attached from the frame to the panel.

Figure 49: 94A0576 Type Output Lightning Arrestors



5. Loosen the 11/16-inch wire retaining nuts for 200, 201, 203, ST1, ST2 and 202 and disconnect.
6. Remove the (4) #10 x 32 pan-head screws and retain until later.
7. Replace the Input Lightning Arrestor assembly.
Replace and tighten the screws on the assembly plate.
8. Connect the wires for 200, 201, 203, ST1, ST2 and 202 and tighten retaining nuts.
9. Connect the ground wire from the frame to the side panel.
10. Put the side panel back on the CCR with the 8 screws.
11. Restore the SCO to the ON position.

8.0 CRT Parts

To order parts, call ADB Safegate Customer Service or your local representative. Use this parts list, and the accompanying illustration, to describe and locate parts correctly.



8.1 CRT Kits

Various kits are available to customize CCRs for specific application requirements. Some kits are integrated within the regulator. If a CCR is desired with an integrated kit, please contact ADB Safegate sales.

Current Sensing AC Relay Kit	Contact ADB Safegate Sales
Provides a dedicated AC contact closure if CCR output current is present.	
Current Sensing DC Relay Kit	Contact ADB Safegate Sales
Provides a dedicated DC contact closure if CCR output current is present.	
Door Documentation Kit	Contact ADB Safegate Sales
Provides a pocket for CCR documentation on the inside of the front door.	
SCO Kit	94A0341
This kit is used to install an SCO Series Circuit Cutout (PN 1475.92.030).	

Kit Notes

- A ferroresonant CCR is preferred for airports that require low output harmonic content (EMI) or that have varying loads, such as Runway Guard Lights using incandescent (tungsten -halogen) lamps, L-849 REILs using xenon flash lamps, or Runway Status Lights (RWSL).

8.2 Spare Parts

Part Number	Description	Location
EU00005-105-01	SCR assembly for 4kW	Figure 51
EU00005-136-01	SCR assembly for 5-7.5kW	Figure 51
EU00005-170-01	SCR assembly for 10kW	Figure 51
EU00005-250-01	SCR assembly for 15kW	Figure 51
EU00005-330-01	SCR assembly for 20kW	Figure 51
EU00005-500-01	SCR assembly for 25-30kW	Figure 51
35A0546	Transformer T4 for 15-30KW, 208-480V	Figure 51
35A0539	Transformer T4 for 4-10KW, 208-480V	Figure 51
35A0796	Transformer T4 for 600V	Figure 51
35A0548	Current Sensor for 6.6A	Figure 52
35A0528	Current Sensor for 20A	Figure 52
35A0631-100	Current Transformer 100A:5A 50-400HZ 600V	Figure 51
44A6397	PCB IRMS-LI (Low Impedance)	Figure 52
44A7693	PCB URC4 Control	Figure 51
94A0341	S1 Cutout SCO	Figure 51
47AXXXX	FUSE See fuse tables (F1-2) and (F3-4)	Table 19 and Table 20
53A0XXX	Contactors K2 - see Contactor Table	Table 21
32A0114	Surge Arrestor for 15-30kW, 6.6A	Figure 51
32A0115	Surge Arrestor for 4-10kW, 6.6A and ALL 20A	Figure 51
94B0011	Input Varistor Assembly	Figure 51
32A0264	Current Transformer 6.6A/66mA	Figure 52
72A0010	Ground Lug	
45A0303	Door Interlock Switch SPST 0.1A ON-OFF	
60A4426	Door Interlock Switch Bracket	
94A0650-ICVM- ACEIII	ICVM ADDER KIT FOR ACEIII	
44A6178	3-Step Brightness Control PCB	
44A6178/5	5-Step Brightness Control PCB	
61A0340	Remote Operator Knob	
52A0107	L-828 Analog Ammeter 6.6A	
52A0098	L-828 Analog Ammeter 20A	

8.3 Assembly Parts

Figure 51: Component Assembly AS00037-XXXXXXX-01 Parts (front)

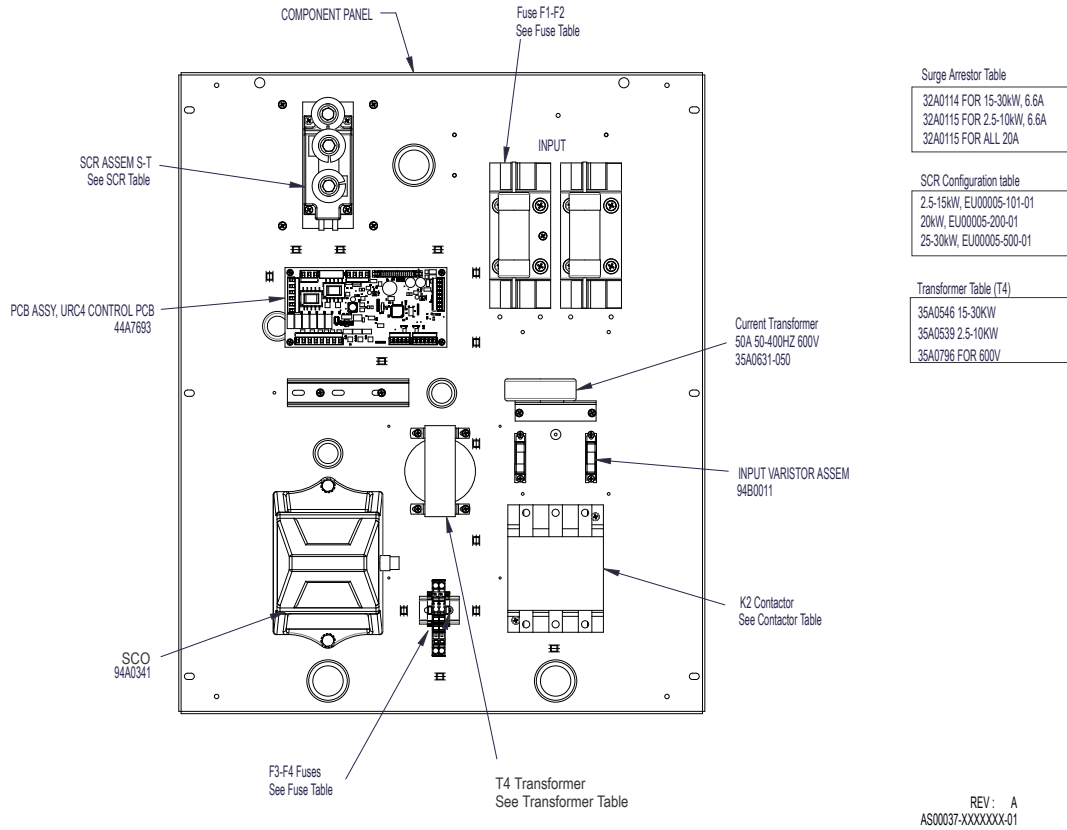

Figure 52: Component Assembly AS00037-XXXXXXX-01 Parts (back)

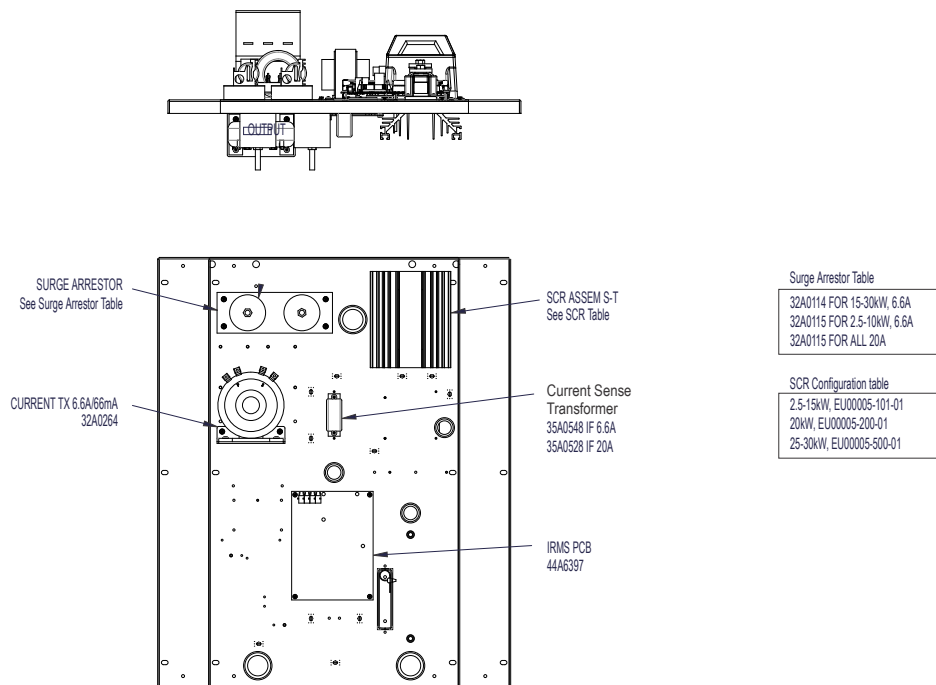

Table 19: F3-F4 Fuses

CRT Size/Voltage	Part #
4-10kW, 347-480V	EZ00002-501-01, 500V, 1A
4-10kW, 208-240V	EZ00002-502-01, 500V, 2A
15-30kW	EZ00002-503-01, 500V, 3.15A
4-30kW, 600V	EZ00002-601-01, 600V, 1A

Table 20: F1-F2 Fuses

REG SIZE	208V	220V	240V	347V	380V-400V	480V	600V
4KW	47A0092, 30A 250V	47A0092, 30A 250V	47A0069, 25A 250V	47A0191, 20A 600V	47A0191, 20A 600V	47A0090, 12A 600V	47A0223, 10A 600V
7.5KW	47A0093, 50A 250V	47A0093, 50A 250V	47A0070, 45A 250V	47A0193, 35A 600V	47A0085, 30A 600V	47A0091, 25A 600V	47A0191, 20A 600V
10KW	47A0094, 70A 250V	47A0094, 70A 250V	47A0071, 60A 250V	47A0086, 40A 600V	47A0086, 40A 600V	47A0085, 30A 600V	47A0091, 25A 600V
15KW	47A0099, 110A 250V	47A0099, 110A 250V	47A0083, 90A 250V	47A0087, 60A 600V	47A0087, 60A 600V	47A0088, 50A 600V	47A0086, 40A 600V
20KW	47A0230, 150A 250V	47A0072, 125A 250V	47A0072, 125A 250V	47A0097, 90A 600V	47A0217, 80A 600V	47A0087, 60A 600V	47A0224, 45A 600V
30KW	47A0102, 200A 250V	47A0102, 200A 250V	47A0101, 175A 250V	47A0106, 125A 600V	47A0106, 125A 600V	47A0097, 90A 600V	47A0225, 70A, 600V

Table 21: Contactors K2

REG SIZE	208 - 240V	347V	380-400V	480V	600V
4KW	53A0412/30	53A0412/25	53A0412/25	53A0412/25	53A0412/25
7.5KW	53A0412/50	53A0412/40	53A0412/40	53A0412/40	53A0412/25
10KW	53A0412/75	53A0412/40	53A0412/40	53A0412/40	53A0412/25
15KW	53A0412/120	53A0412/60	53A0412/60	53A0412/50	53A0412/40
20KW	53A0412/150	53A0412/90	53A0412/90	53A0412/60	53A0412/50
30KW	53A0331	53A0412/150	53A0412/150	53A0412/90	53A0412/75

9.0 SUPPORT

Our experienced engineers are available for support and service at all times, 24 hour/7 days a week. They are part of a dynamic organization making sure the entire ADB SAFEGATE is committed to minimal disturbance for airport operations.

ADB SAFEGATE Support

Live Technical Support - Americas

If at any time you have a question or concern about your product, just contact ADB SAFEGATE's technical service department. Trained in all areas of system issues, troubleshooting, quality control and technical assistance, our highly experienced Technical support specialists are available 24 hours a day, seven days a week to provide assistance over the phone.

ADB SAFEGATE **Americas Technical Service & Support (US & Canada): +1-800-545-4157**

ADB SAFEGATE Americas Technical Service & Support (International): +1-614-861-1304

During regular business hours, you can also Chat with a Service Technician. We look forward to working with you!

Before You Call

When you have an airfield lighting or system control system problem it is our goal to support airfield maintenance staff as quickly as possible. To support this effort we ask that you have the following information ready before calling.

- The *airport code*
- If not with an airport, then company name (prefer customer id number)
- Contact phone number and email address
- Product with part number preferable or product number
- Have you reviewed the product's manual and troubleshooting guide
- Do you have a *True RMS* meter available (and any other necessary tools)
- Be located with the product ready to troubleshoot

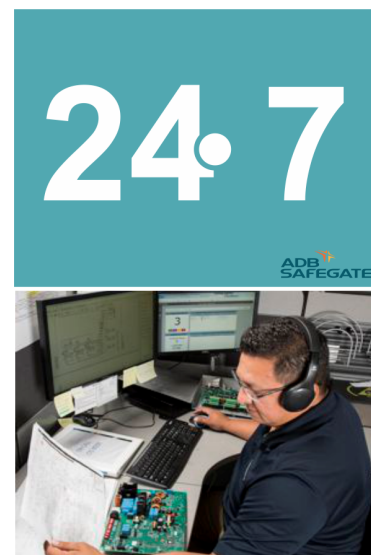

Note

For more information, see www.adbsafegate.com, or contact ADB SAFEGATE Support via email at support@adbsafegate.com or

Brussels: +32 2 722 17 11

Rest of Europe: +46 (0) 40 699 17 40

Americas: +1 614 861 1304. Press 3 for technical service or press 4 for sales support.

China: +86 (10) 8476 0106

9.1 ADB SAFEGATE Website

The ADB SAFEGATE website, www.adbsafegate.com, offers information regarding our airport solutions, products, company, news, links, downloads, references, contacts and more.

9.2 Recycling

9.2.1 Local Authority Recycling

The disposal of ADB SAFEGATE products is to be made at an applicable collection point for the recycling of electrical and electronic equipment. The correct disposal of equipment prevents any potential negative consequences for the environment and human health, which could otherwise be caused by inappropriate waste handling. The recycling of materials helps to conserve natural resources. For more detailed information about recycling of products, contact your local authority city office.

9.2.2 ADB SAFEGATE Recycling

ADB SAFEGATE is fully committed to environmentally-conscious manufacturing with strict monitoring of our own processes as well as supplier components and sub-contractor operations. ADB SAFEGATE offers a recycling program for our products to all customers worldwide, whether or not the products were sold within the EU.

ADB SAFEGATE products and/or specific electrical and electronic component parts which are fully removed/separated from any customer equipment and returned will be accepted for our recycling program.

All items returned must be clearly labeled as follows:

- For *ROHS/WEEE* Recycling
- Sender contact information (Name, Business Address, Phone number).
- Main Unit Serial Number.

ADB SAFEGATE will continue to monitor and update according for any future requirements for *EU directives* as and when *EU member states* implement new *regulations* and or *amendments*. It is our aim to maintain our *compliance plan* and assist our customers.

Company Addresses

ADB SAFEGATE, Belgium	ADB SAFEGATE BV Leuvensesteenweg 585, B-1930 Zaventem Belgium
Contact: Tel.: +32 2 722 17 11 Fax: +32 2 722 17 64	Email: marketing@adbsafegate.com Internet: www.adbsafegate.com
ADB SAFEGATE, Americas	ADB SAFEGATE Americas LLC 977 Gahanna Parkway, Columbus, OH 43230 USA
Contact: Tel.: +1 (614) 861 1304 Fax: +1 (614) 864 2069	Email: sales.us@adbsafegate.com Internet: www.adbsafegate.com
ADB SAFEGATE, Sweden	ADB SAFEGATE Sweden AB Djurhagegatan 19 SE-213 76 Malmö Sweden
Contact: Tel.: +46 (0)40 699 17 00 Fax: +46 (0)40 699 17 30	Email: marketing@adbsafegate.com Internet: www.adbsafegate.com
ADB SAFEGATE, China	ADB SAFEGATE Airfield Technologies Ltd. China Unit 603, D Block, CAMIC International Convention Center, No 3, Hua Jia Di East road, ChaoYang district, Beijing 100102 P.R. China
Contact: Tel.: +86 (10) 8476 0106 Fax: +86 (10) 8476 0090	Email: china@safegate.com Internet: www.adbsafegate.com
ADB SAFEGATE, Germany	ADB SAFEGATE Germany GmbH Konrad-Zuse-Ring 6, D-68163 Mannheim Germany
Contact: Tel.: +49 (621) 87 55 76-0 Fax: +49 (621) 87 55 76-55	Email: marketing@adbsafegate.com Internet: www.adbsafegate.com



Powering Your Airport Performance from Approach to Departure

adbsafegate.com

Copyright © ADB SAFEGATE, all rights reserved

