



# Primary Connector Kit (PRK) Installation Instructions

**User Manual**

UM-7017, Rev. B, 2025/07/25

**ADB**   
**SAFEGATE**



## A.0 Disclaimer / Standard Warranty

### CE certification

The equipment listed as CE certified means that the product complies with the essential requirements concerning safety and hygiene. The European directives that have been taken into consideration in the design are available on written request to ADB SAFEGATE.

### ETL certification

The equipment listed as ETL certified means that the product complies with the essential requirements concerning safety and C22.2 No.180:13 (R2018) regulations. The CSA directives that have been taken into consideration in the design are available on written request to ADB SAFEGATE.

### All Products Guarantee

ADB SAFEGATE will correct by repair or replacement per the applicable guarantee below, at its option, equipment or parts which fail because of mechanical, electrical or physical defects, provided that the goods have been properly handled and stored prior to installation, properly installed and properly operated after installation, and provided further that Buyer gives ADB SAFEGATE written notice of such defects after delivery of the goods to Buyer. Refer to the Safety section for more information on Material Handling Precautions and Storage precautions that must be followed.

ADB SAFEGATE reserves the right to examine goods upon which a claim is made. Said goods must be presented in the same condition as when the defect therein was discovered. ADB SAFEGATE further reserves the right to require the return of such goods to establish any claim.

ADB SAFEGATE's obligation under this guarantee is limited to making repair or replacement within a reasonable time after receipt of such written notice and does not include any other costs such as the cost of removal of defective part, installation of repaired product, labor or consequential damages of any kind, the exclusive remedy being to require such new parts to be furnished.

ADB SAFEGATE's liability under no circumstances will exceed the contract price of goods claimed to be defective. Any returns under this guarantee are to be on a transportation charges prepaid basis. For products not manufactured by, but sold by ADB SAFEGATE, warranty is limited to that extended by the original manufacturer. This is ADB SAFEGATE's sole guarantee and warranty with respect to the goods; there are no express warranties or warranties of fitness for any particular purpose or any implied warranties of fitness for any particular purpose or any implied warranties other than those made expressly herein. All such warranties being expressly disclaimed.

### Standard Products Guarantee

Products manufactured by ADB SAFEGATE are guaranteed against mechanical, electrical, and physical defects (excluding lamps) which may occur during proper and normal use for a period of two years from the date of ex-works delivery, and are guaranteed to be merchantable and fit for the ordinary purposes for which such products are made.



### Note

See your applicable sales agreement for a complete warranty description.

Replaced or repaired equipment under warranty falls into the warranty of the original delivery. No new warranty period is started for these replaced or repaired products.

### FAA Certified products manufactured by ADB SAFEGATE

ADB SAFEGATE L858 Airfield Guidance Signs are warranted against mechanical and physical defects in design or manufacture for a period of 2 years from date of installation, per FAA AC 150/5345-44 (applicable edition).

ADB SAFEGATE LED products (with the exception of obstruction lighting) are warranted against electrical defects in design or manufacture of the LED or LED specific circuitry for a period of 4 years from date of installation, per FAA EB67 (applicable edition). These FAA certified constant current (series) powered LED products must be installed, interfaced and powered with and through products certified under the FAA Airfield Lighting Equipment Program (ALECP) to be included in this 4 (four) year warranty. This includes, but is not limited to, interface with products such as Base Cans, Isolation Transformers, Connectors, Wiring, and Constant Current Regulators.



## Note

See your sales order contract for a complete warranty description.

Replaced or repaired equipment under warranty falls into the warranty of the original delivery. No new warranty period is started for these replaced or repaired products.

---

## Liability



### WARNING

Use of the equipment in ways other than described in the catalog leaflet and the manual may result in personal injury, death, or property and equipment damage. Use this equipment only as described in the manual.

ADB SAFEGATE cannot be held responsible for injuries or damages resulting from non-standard, unintended uses of its equipment. The equipment is designed and intended only for the purpose described in the manual. Uses not described in the manual are considered unintended uses and may result in serious personal injury, death or property damage.

Unintended uses, includes the following actions:

- Making changes to equipment that have not been recommended or described in this manual or using parts that are not genuine ADB SAFEGATE replacement parts or accessories.
- Failing to make sure that auxiliary equipment complies with approval agency requirements, local codes, and all applicable safety standards if not in contradiction with the general rules.
- Using materials or auxiliary equipment that are inappropriate or incompatible with your ADB SAFEGATE equipment.
- Allowing unskilled personnel to perform any task on or with the equipment.

## Copyright Statement

This manual or parts thereof may not be reproduced, stored in a retrieval system, or transmitted, in any form or by any means, electronic, mechanical, photocopying, recording, nor otherwise, without the author's prior written consent.

This manual could contain technical inaccuracies or typographical errors. The author reserves the right to revise this manual from time to time in the contents thereof without obligation of the author to notify any person of such revision or change. Details and values given in this manual are average values and have been compiled with care. They are not binding, however, and the author disclaims any liability for damages or detriments suffered as a result of reliance on the information given herein or the use of products, processes or equipment to which this manual refers. No warranty is made that the use of the information or of the products, processes or equipment to which this manual refers will not infringe any third party's patents or rights. The information given does not release the buyer from making their own experiments and tests.

# Table of Contents

<b>1.0 Safety</b> .....	<b>1</b>
1.1 Safety Messages.....	1
1.1.1 Introduction to Safety.....	2
1.1.2 Intended Use.....	2
1.1.3 Material Handling Precautions: Storage.....	3
1.1.4 Material Handling Precautions: Fasteners.....	3
1.1.5 Maintenance Safety.....	3
1.1.6 Material Handling Precautions, ESD.....	4
1.1.7 Arc Flash and Electric Shock Hazard.....	4
<b>2.0 Primary Connector Kit (PRK) Installation Instructions</b> .....	<b>5</b>
2.1 Safety Precautions.....	5
2.2 Ordering Code.....	5
2.3 Ordering Code.....	0
2.4 Assembly of Connector Kit.....	6
2.5 Assembly of plug and receptacle.....	7
<b>3.0 SUPPORT</b> .....	<b>9</b>
3.1 ADB SAFEGATE Website.....	9
3.2 Recycling.....	10
3.2.1 Local Authority Recycling.....	10
3.2.2 ADB SAFEGATE Recycling.....	10

# List of Figures

# 1.0 Safety

## Introduction to Safety

This section contains general safety instructions for installing and using ADB SAFEGATE equipment. Some safety instructions may not apply to the equipment in this manual. Task- and equipment-specific warnings are included in other sections of this manual where appropriate.

## 1.1 Safety Messages

### HAZARD Icons used in this manual

For all HAZARD symbols in use, see the Safety section. All symbols must comply with ISO and ANSI standards.

Carefully read and observe all safety instructions in this manual, which alert you to safety hazards and conditions that may result in personal injury, death or property and equipment damage and are accompanied by the symbols shown below.

	<p>WARNING</p> <p>Failure to observe a warning may result in personal injury, death or equipment damage.</p>
	<p>DANGER – Risk of electrical shock or ARC FLASH</p> <p>Disconnect equipment from line voltage. Failure to observe this warning may result in personal injury, death, or equipment damage. ARC Flash may cause blindness, severe burns or death.</p>
	<p>WARNING – Wear personal protective equipment</p> <p>Failure to observe may result in serious injury.</p>
	<p>WARNING – Do not touch</p> <p>Failure to observe this warning may result in personal injury, death, or equipment damage.</p>
	<p>CAUTION</p> <p>Failure to observe a caution may result in equipment damage.</p>
	<p>ELECTROSTATIC SENSITIVE DEVICES</p> <p>This equipment may contain electrostatic devices.</p>

### Qualified Personnel

	<p><b>Important Information</b></p> <p>The term <b>qualified personnel</b> is defined here as individuals who thoroughly understand the equipment and its safe operation, maintenance and repair. Qualified personnel are physically capable of performing the required tasks, familiar with all relevant safety rules and regulations and have been trained to safely install, operate, maintain and repair the equipment. It is the responsibility of the company operating this equipment to ensure that its personnel meet these requirements.</p> <p>Always use required personal protective equipment (PPE) and follow safe electrical work practice.</p>
--	---

## 1.1.1 Introduction to Safety



### CAUTION

#### Unsafe Equipment Use

This equipment may contain electrostatic devices, hazardous voltages and sharp edges on components

- Read installation instructions in their entirety before starting installation.
- Become familiar with the general safety instructions in this section of the manual before installing, operating, maintaining or repairing this equipment.
- Read and carefully follow the instructions throughout this manual for performing specific tasks and working with specific equipment.
- Make this manual available to personnel installing, operating, maintaining or repairing this equipment.
- Follow all applicable safety procedures required by your company, industry standards and government or other regulatory agencies.
- Install all electrical connections to local code.
- Use only electrical wire of sufficient gauge and insulation to handle the rated current demand. All wiring must meet local codes.
- Route electrical wiring along a protected path. Make sure they will not be damaged by moving equipment.
- Protect components from damage, wear, and harsh environment conditions.
- Allow ample room for maintenance, panel accessibility, and cover removal.
- Protect equipment with safety devices as specified by applicable safety regulations
- If safety devices must be removed for installation, install them immediately after the work is completed and check them for proper functioning prior to returning power to the circuit.

**Failure to follow these instructions can result in serious injury, death or equipment damage**

## Additional Reference Materials



#### Important Information

- IEC – International Standards and Conformity Assessment for all electrical, electronic and related technologies.
- IEC 60364 – Electrical Installations in Buildings.
- CSA – C22.2 No.180:13 (R2018), series isolating transformers for airport lighting.
- FAA Advisory: AC 150/5340-26 (current edition), Maintenance of Airport Visual Aid Facilities.
- Maintenance personnel must refer to the maintenance procedure described in the ICAO Airport Services Manual, Part 9.
- ANSI/NFPA 79, Electrical Standards for Metalworking Machine Tools.
- National and local electrical codes and standards.

## 1.1.2 Intended Use



### CAUTION

#### Use this equipment as intended by the manufacturer.

This equipment is designed to perform a specific function. Do not use this equipment for other purposes.

**Failure to follow this instruction can result in serious injury, death or equipment damage.**

### 1.1.3 Material Handling Precautions: Storage



#### CAUTION

##### Improper Storage

Store this equipment properly

- If equipment is to be stored prior to installation, it must be protected from the weather elements and kept free of condensation and dust.

**Failure to follow this instruction can result in equipment damage**

### 1.1.4 Material Handling Precautions: Fasteners



#### DANGER

##### FOREIGN OBJECT DAMAGE - FOD

THIS EQUIPMENT MAY CONTAIN FASTENERS THAT CAN LOOSEN UNLESS TORQUED PROPERLY.

- ONLY USE FASTENERS OF THE SAME TYPE AS ORIGINALLY SUPPLIED WITH THE EQUIPMENT.
- USE OF INCORRECT COMBINATION OF GASKETS, BOLTS AND NUTS CAN CAUSE SEVERE DAMAGE TO THE PRODUCT AND CREATE MULTIPLE SAFETY RISKS .
- YOU NEED TO KNOW WHAT BASE THE LIGHT FIXTURE WILL BE INSTALLED IN, IN ORDER TO CHOOSE THE CORRECT GASKET, BOLTS AND NUTS.
- BOLT TYPE, LENGTH, AND TORQUE VALUE ARE DETERMINED BY TYPE OF BASE, HEIGHT OF SPACERS USED, AND CLAMP FORCE REQUIRED IN FAA ENGINEERING BRIEF NO 83 (LATEST REVISION).
- USE ONLY ANTI-VIBRATION WASHERS WITH THE FIXING BOLTS AS DEFINED IN FAA EB 83 (LATEST EDITION) TO AVOID THE RISK OF LOOSENING BOLTS . DO NOT USE OF ANY OTHER TYPE OF WASHER (SUCH AS SPLIT-LOCK WASHERS). FOR INSTALLATION OTHER THAN FAA, USE THE BASE CAN MANUFACTURER'S RECOMMENDATIONS.
- ALWAYS TIGHTEN THE FASTENERS TO THE RECOMMENDED TORQUE USING A CALIBRATED TORQUE WRENCH.
- APPLY THE RECOMMENDED TYPE OF ADHESIVE AND FOLLOW THE ADHESIVE INSTRUCTIONS CAREFULLY.

**FAILURE TO FOLLOW THESE WARNINGS MAY CAUSE THE FASTENERS TO LOOSEN, POSSIBLY DAMAGING THE EQUIPMENT. THIS CAN LEAD TO THE HIGHLY DANGEROUS SITUATION OF FOD, WITH POTENTIALLY LETHAL CONSEQUENCES.**



#### Note

To minimize the risk of errors, the ADB SAFEGATE Sales Representative will have information on which gasket goes with which base. This information is also provided in the product Data sheets, the User Manuals and the Spare Part Lists.

### 1.1.5 Maintenance Safety



#### DANGER

##### ELECTRIC SHOCK HAZARD

THIS EQUIPMENT MAY CONTAIN ELECTROSTATIC DEVICES

- DO NOT OPERATE A SYSTEM THAT CONTAINS MALFUNCTIONING COMPONENTS. IF A COMPONENT MALFUNCTIONS, TURN THE SYSTEM OFF IMMEDIATELY.
- DISCONNECT AND LOCK OUT ELECTRICAL POWER.
- ALLOW ONLY QUALIFIED PERSONNEL TO MAKE REPAIRS OR REPLACE MALFUNCTIONING COMPONENTS ACCORDING TO INSTRUCTIONS PROVIDED IN MANUAL.

**FAILURE TO FOLLOW THESE INSTRUCTIONS CAN RESULT IN DEATH OR EQUIPMENT DAMAGE**

## 1.1.6 Material Handling Precautions, ESD



### CAUTION

#### Electrostatic Sensitive Devices

This equipment may contain electrostatic devices

- Protect from electrostatic discharge.
- Electronic modules and components should be touched only when this is unavoidable e.g. soldering, replacement.
- Before touching any component of the cabinet you shall bring your body to the same potential as the cabinet by touching a conductive earthed part of the cabinet.
- Electronic modules or components must not be brought in contact with highly insulating materials such as plastic sheets, synthetic fiber clothing. They must be laid down on conductive surfaces.
- The tip of the soldering iron must be grounded.
- Electronic modules and components must be stored and transported in conductive packing.

**Failure to follow this instruction can result in equipment damage**

## 1.1.7 Arc Flash and Electric Shock Hazard



### DANGER

#### SERIES CIRCUITS HAVE HAZARDOUS VOLTAGES

THIS EQUIPMENT PRODUCES HIGH VOLTAGES TO MAINTAIN THE SPECIFIED CURRENT - DO NOT DISCONNECT WHILE ENERGIZED.

- ALLOW ONLY QUALIFIED PERSONNEL TO PERFORM MAINTENANCE, TROUBLESHOOTING, AND REPAIR TASKS.
- ONLY PERSONS WHO ARE PROPERLY TRAINED AND FAMILIAR WITH ADB SAFEGATE EQUIPMENT ARE PERMITTED TO SERVICE THIS EQUIPMENT.
- AN OPEN AIRFIELD CURRENT CIRCUIT IS CAPABLE OF GENERATING >5000 VAC AND MAY APPEAR OFF TO A METER.
- NEVER UNPLUG A DEVICE FROM A CONSTANT CURRENT CIRCUIT WHILE IT IS OPERATING; ARC FLASH MAY RESULT.
- DISCONNECT AND LOCK OUT ELECTRICAL POWER.
- ALWAYS USE SAFETY DEVICES WHEN WORKING ON THIS EQUIPMENT.
- FOLLOW THE RECOMMENDED MAINTENANCE PROCEDURES IN THE PRODUCT MANUALS.
- DO NOT SERVICE OR ADJUST ANY EQUIPMENT UNLESS ANOTHER PERSON TRAINED IN FIRST AID AND CPR IS PRESENT.
- CONNECT ALL DISCONNECTED EQUIPMENT GROUND CABLES AND WIRES AFTER SERVICING EQUIPMENT. GROUND ALL CONDUCTIVE EQUIPMENT.
- USE ONLY APPROVED ADB SAFEGATE REPLACEMENT PARTS. USING UNAPPROVED PARTS OR MAKING UNAPPROVED MODIFICATIONS TO EQUIPMENT MAY VOID AGENCY APPROVALS AND CREATE SAFETY HAZARDS.
- CHECK THE INTERLOCK SYSTEMS PERIODICALLY TO ENSURE THEIR EFFECTIVENESS.
- DO NOT ATTEMPT TO SERVICE ELECTRICAL EQUIPMENT IF STANDING WATER IS PRESENT. USE CAUTION WHEN SERVICING ELECTRICAL EQUIPMENT IN A HIGH-HUMIDITY ENVIRONMENT.
- USE TOOLS WITH INSULATED HANDLES WHEN WORKING WITH AIRFIELD ELECTRICAL EQUIPMENT.

**FAILURE TO FOLLOW THESE INSTRUCTIONS CAN RESULT IN DEATH OR EQUIPMENT DAMAGE**

## 2.0 Primary Connector Kit (PRK) Installation Instructions

### 2.1 Safety Precautions

- **AGL equipment should be installed only by competent personnel.**  
Operating and maintenance personnel should refer to IEC standard 61821, ICAO Airport Services Manual Part 9, "Airport Maintenance Practices" and to FAA Advisory Circular AC 150/5340-26 "Maintenance of Airport Visual Aid Facilities" for instructions on safety precautions. Personnel must always observe the safety regulations. The equipment has been designed and manufactured to allow safe and secure operation, however, the listed rules must be strictly observed.
- **Prior to installation and disconnection, de-energize all cables and equipment.**
- **Inspect all parts for rating and compatibility.**

### 2.2 Ordering Code

#### Ordering Code

Cable Type  
 Insulation Outside Diameter  
 Wire Size (Stranded)

PRK    000000

#### Cable Type

U = Unscreened  
 S = Screened



#### Insulation Outside Diameter

1 = 8.0-11.5 mm (0.315-0.453 inch)  
 2 = 11.0-14.5 mm (0.433-0.571 inch)  
 3 = 14.0-18.5 mm (0.551-0.728 inch)

#### Wire Size (Stranded)

A = 10 mm<sup>2</sup> (AWG 6)  
 B = 6 mm<sup>2</sup> (AWG 8)

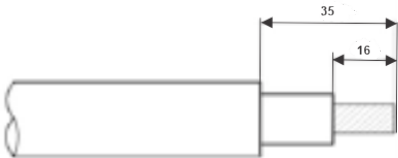
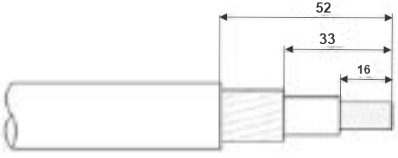
## 2.3 Assembly of Connector Kit

Sequence		Description						
Unscreened cable	Screened cable							
1	1	Clean the cable end to be inserted into the connector kit housing 15 mm (6") to 20 mm (8") with a solvent.						
2	2	<p>Prepare / strip the cable as shown in the drawings below:</p> <p><b>CAUTION</b> Do not overstrip and cut into conductors/insulation.</p> <div style="display: flex; justify-content: space-around;"> <div style="text-align: center;"> <p>Unscreened cable</p>  </div> <div style="text-align: center;"> <p>Screened cable</p>  </div> </div>						
3	3	<p>Crimp the conductor into the crimp barrel of the pin / socket contact of the kit. Recommended crimping tools</p> <table border="1" style="width: 100%; border-collapse: collapse;"> <thead> <tr> <th style="text-align: center;">Crimping Tool</th> <th style="text-align: center;">Part Number</th> </tr> </thead> <tbody> <tr> <td style="text-align: center;">Thomas &amp; Betts TBM45S</td> <td style="text-align: center;">TBM45S</td> </tr> <tr> <td style="text-align: center;">Channellock 909</td> <td style="text-align: center;">CHANNEL909</td> </tr> </tbody> </table> <p><b>Note</b> Always crimp the barrel of the pin/socket twice. The second crimp shall be rotated 90° from the 1st crimp, approximately 6-7mm apart.</p>	Crimping Tool	Part Number	Thomas & Betts TBM45S	TBM45S	Channellock 909	CHANNEL909
Crimping Tool	Part Number							
Thomas & Betts TBM45S	TBM45S							
Channellock 909	CHANNEL909							
	4	<p>Gradually press the screen sleeve around the cable screen as shown below. Apply Grease at the cable/ contact assy and if available the earth conductor and its transparent sleeve [The transparent sleeve has to be positioned closest to the crimped ring],</p>  <p><b>CAUTION</b> Ensure no sharp edges are on the screen sleeve after the "pressing" action is complete.</p>						

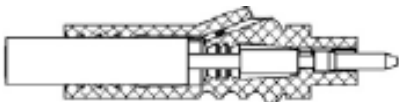
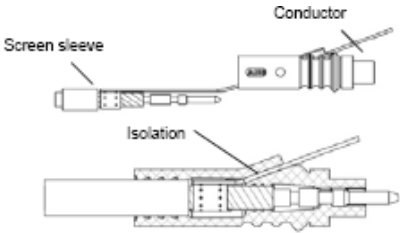
Sequence		Description
Unscreened cable	Screened cable	
4	4	<p>Slide the above cable/pin or cable/receptacle assy into the respective connector housings. For the receptacle, use the plastic "paw" as a guide and to prevent grease from getting into the socket contact :</p>  <p>In case of screened cable, make sure that the conductor connected to the screen sleeve is pushed through the isolation as shown below.</p> <hr/> <p><b>i Note</b> For a good, watertight connection, make sure to perform this assembly in one smooth single sequence. <i>Repeated sliding in both directions may jeopardize the water tightness.</i></p>
		<div style="display: flex; justify-content: space-around;"> <div style="text-align: center;"> <p>Unscreened cable</p>  </div> <div style="text-align: center;"> <p>Screened cable</p>  </div> </div>

## 2.4 Assembly of plug and receptacle

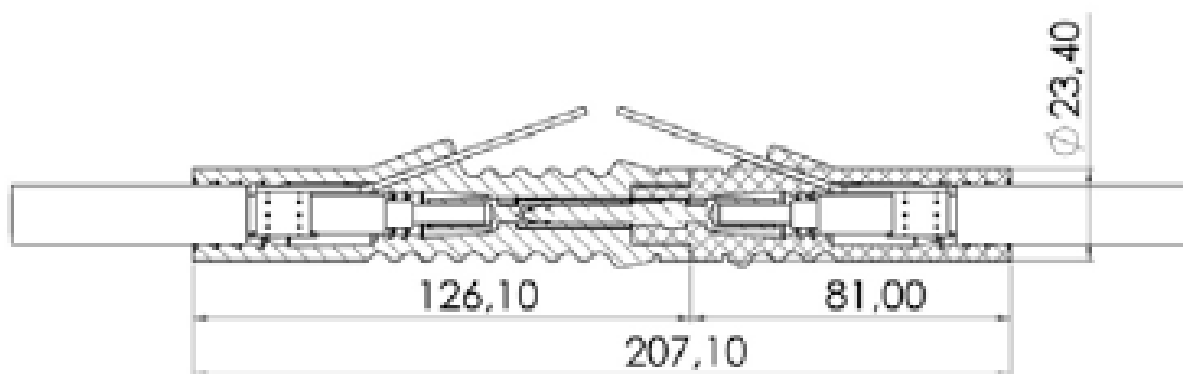

1. While making electrical contact between plug and receptacle, air captured between the two parts of the water seal may resist complete insertion. This is especially the case when one or both parts are lubricated. To overcome the phenomenon proceed as follows:
  - a. Fold a piece of paper or electrical tape ( with adhesive sides together)
  - b. Place inside the receptacle and insert the plug.
  - c. Pull out the folded paper or tape.

2. To prevent water and dirt ingress, apply 2 layers of self-vulcanizing tape (Scotch 23, 130C, or similar) around the connection joint, half-overlapped, extending at least 1-1.5 in (25-38 mm). This will keep the connection clean and dry, preventing water and dirt from being drawn into the water seal when the connector gets separated. For another layer of protection, wrap a layer of electrical tape (Scotch 33+ or similar) or heat shrink sleeve over the rubber taps. Apply 2 layers of self vulcanizing tape (Scotch 23, 130C or similar) around the joint of the connectors, ½ overlapped, extending at least 25 to 38mm (1 to 1 ½") in order to keep it dry and clean, and hence preventing water and dirt being drawn into the water seal when the connector gets separated. Wrap another layer of electrical tape (Scotch 33+ or equivalent - e.g. heat shrink sleeve) over the rubber tape.

## 3.0 SUPPORT

Our experienced engineers are available for support and service at all times, 24 hour/7 days a week. They are part of a dynamic organization making sure the entire ADB SAFEGATE is committed to minimal disturbance for airport operations.

### ADB SAFEGATE Support

#### Technical Support – Global

Customers in Europe, the Middle East, Africa or Asia Pacific are more than welcome to our portal for technical support. Trained in all areas of system issues, troubleshooting, quality control and technical assistance, our highly experienced Technical support specialists are available 24 hours a day, seven days a week to provide assistance over the phone. In the Americas, we also offer live technical support.

#### Live Technical Support – Americas

If at any time you have a question or concern about your product, contact ADB SAFEGATE's US-based technical support specialists, available 24 hours a day, seven days a week, to assist you via phone.

ADB SAFEGATE Americas Technical Service & Support (US & Canada) :+1-800-545-4157

ADB SAFEGATE Americas Technical Service & Support (Canada): +1-905-631-1597

ADB SAFEGATE Americas Technical Service & Support (International): +1-614-861-1304

We can also be reached via email during regular business hours:

Airfield and Gate: [techservice.us@adbsafegate.com](mailto:techservice.us@adbsafegate.com)

Gate: [gateservice.us@adbsafegate.com](mailto:gateservice.us@adbsafegate.com)

We look forward to working with you!

#### Before You Call

When you have an airfield lighting or system control system problem, prior to calling, please ensure the following:

- Review the product's manual and troubleshooting guide.
- Be located with the product ready to troubleshoot.
- Have all necessary information available: airport code/company name, customer id number, contact phone number/email address, product/part number.
- Have a True RMS meter available and any other necessary tools.

When calling about an issue with Safedock A-VDGS, we can serve you better if you collect the following information before you call:

- Relevant information regarding the issue you are calling about, such as gate number, flight number, aircraft type and time of the event.
- What, if any, actions have been taken to resolve the issue prior to the call.
- If available, provide a CCTV recording of the incident to aid in aligning the information from the Safedock log file.

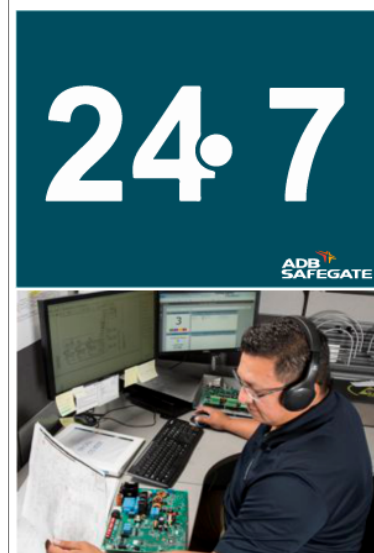

### Note

For more information, see [www.adbsafegate.com](http://www.adbsafegate.com), contact ADB SAFEGATE Support via email at [support@adbsafegate.com](mailto:support@adbsafegate.com) or Europe: +32 2 722 17 11

Americas: +1 614 861 1304. Press 3 for technical service or press 4 for sales support.

China: +86 (10) 8476 0106

Middle East and Africa: +971 4 452 7575

## 3.1 ADB SAFEGATE Website

The ADB SAFEGATE website, [www.adbsafegate.com](http://www.adbsafegate.com), offers information regarding our airport solutions, products, company, news, links, downloads, references, contacts and more.

## 3.2 Recycling

### 3.2.1 Local Authority Recycling

The disposal of ADB SAFEGATE products is to be made at an applicable collection point for the recycling of electrical and electronic equipment. The correct disposal of equipment prevents any potential negative consequences for the environment and human health, which could otherwise be caused by inappropriate waste handling. The recycling of materials helps to conserve natural resources. For more detailed information about recycling of products, contact your local authority city office.

### 3.2.2 ADB SAFEGATE Recycling

ADB SAFEGATE is fully committed to environmentally-conscious manufacturing with strict monitoring of our own processes as well as supplier components and sub-contractor operations. ADB SAFEGATE offers a recycling program for our products to all customers worldwide, whether or not the products were sold within the EU.

ADB SAFEGATE products and/or specific electrical and electronic component parts which are fully removed/separated from any customer equipment and returned will be accepted for our recycling program.

All items returned must be clearly labeled as follows:

- For RoHS/WEEE Recycling
- Sender contact information (Name, Business Address, Phone number).
- Main Unit Serial Number.

ADB SAFEGATE will continue to monitor and update according for any future requirements for EU directives as and when EU member states implement new regulations and or amendments. It is our aim to maintain our compliance plan and assist our customers.

## Company Addresses

ADB SAFEGATE, Belgium	ADB SAFEGATE BV Leuvensesteenweg 585 B-1930 Zaventem Belgium
Contact:	
Tel.: +32 2 722 17 11	Email: <a href="mailto:marketing@adbsafegate.com">marketing@adbsafegate.com</a>
Fax: +32 2 722 17 64	Internet: <a href="http://www.adbsafegate.com">www.adbsafegate.com</a>
ADB SAFEGATE, Americas	ADB SAFEGATE Americas, LLC 700 Science Blvd Gahanna, OH 43230 USA
Contact:	
Tel.: +1 (614) 861 1304	Email: <a href="mailto:sales.us@adbsafegate.com">sales.us@adbsafegate.com</a>
Fax: +1 (614) 864 2069	Internet: <a href="http://www.adbsafegate.com">www.adbsafegate.com</a>
ADB SAFEGATE, Sweden	ADB SAFEGATE Sweden AB Djurhagegatan 19 SE-213 76 Malmö Sweden
Contact:	
Tel.: +46 (0)40 699 17 00	Email: <a href="mailto:marketing@adbsafegate.com">marketing@adbsafegate.com</a>
Fax: +46 (0)40 699 17 30	Internet: <a href="http://www.adbsafegate.com">www.adbsafegate.com</a>
ADB SAFEGATE, China	ADB SAFEGATE Airfield Technologies Ltd. China Unit 603, D Block, CAMIC International Convention Center, No 3, Hua Jia Di East road, ChaoYang district, Beijing 100102 P.R. China
Contact:	
Tel.: +86 (10) 8476 0106	Email: <a href="mailto:china@safegate.com">china@safegate.com</a>
Fax: +86 (10) 8476 0090	Internet: <a href="http://www.adbsafegate.com">www.adbsafegate.com</a>
ADB SAFEGATE, Germany	ADB SAFEGATE Germany GmbH Konrad-Zuse-Ring 6, D-68163 Mannheim Germany
Contact:	
Tel.: +49 (621) 87 55 76-0	Email: <a href="mailto:marketing@adbsafegate.com">marketing@adbsafegate.com</a>
Fax: +49 (621) 87 55 76-55	Internet: <a href="http://www.adbsafegate.com">www.adbsafegate.com</a>

WWW.ADBSAFEGATE.COM

# Empowering the Airside **Evolution**

SMARTER. BETTER. **NOW.**



Copyright ©2023—2025 ADB Safegate, All Rights Reserved