

FloPro™ e3

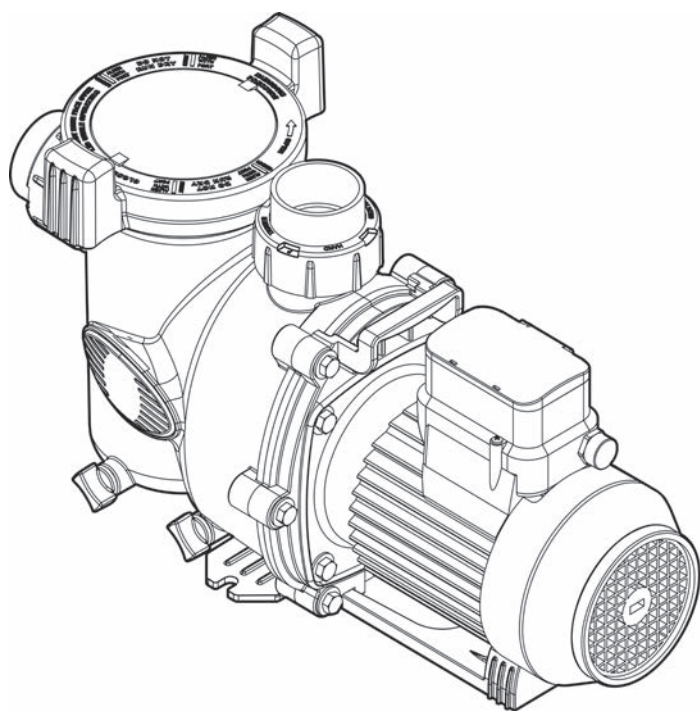

Instructions for installation and use - English
Filtration pump
Translation of the original instructions in french

EN

More documents on:
www.zodiac-poolcare.com

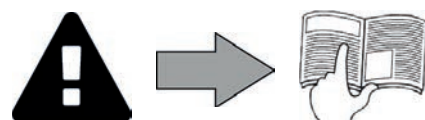



WARNINGS

- Failure to respect the warnings may cause serious damage to the pool equipment or cause serious injury, even death.
- The appliance is intended to be used only for swimming pools and spas; it must not be used for any purpose other than that for which it has been designed.
- It is important that the appliance is operated by people who are competent and qualified (both physically and mentally), after having read the instructions for use. All persons not meeting these criteria must not approach the appliance in order to avoid exposure to dangerous elements.
- Keep the appliance out of the reach of children.
- The appliance must be installed according to the manufacturer's instructions and in compliance with local standards. The installer is responsible for installing the appliance and for compliance with national installation regulations. Under no circumstances may the manufacturer be held liable in the event of failure to comply with applicable local installation standards.
- Incorrect installation and/or use may cause serious damage to property or serious injuries (possibly causing death).
- All equipment, even postage and packing paid, travels at the risks and perils of the recipient. The latter shall issue reserves in writing on the carrier's delivery slip if damage is detected, caused during transport (confirmation to be sent to the carrier within 48 hours by registered letter). In the event that an appliance containing coolant has been turned on its side, mention your reservations in writing to the carrier.
- If the appliance suffers a malfunction, do not try to repair the appliance yourself. Instead contact a qualified technician for service.
- Refer to the warranty conditions for details of the permitted water balance values for operating the appliance.
- Defeating, eliminating or shunting any of the safety that may be a part of the device automatically voids the warranty, as does the use of unauthorized, third party replacement parts.
- Do not spray insecticide or any other chemical (inflammable or non-inflammable) in the direction of the appliance, as this may damage the body and cause a fire.
- The power supply to the appliance must be protected by a dedicated 30 mA residual current device, complying with the standards and regulations in force in the country in which it is installed.
- Do not use an extension cord to plug the appliance into; plug it directly into a proper wall socket or outlet.
- Before carrying out any operations, check that:
 - The voltage indicated on the appliance information plate corresponds to the mains voltage,
 - The power grid is adapted to the power requirements of the appliance, and is properly grounded.
 - The plug (where applicable) is suitable for the socket.
- In the event of abnormal operation or the release of odours from the appliance, turn it off immediately, unplug it from its power supply and contact a professional.
- Before any access to the appliance for any required service or maintenance, ensure that it is switched off and disconnected from the power supply.
- Do not disconnect and reconnect the appliance to the power supply when in operation.
- Do not pull on the power cord to disconnect it from the power supply.
- Do not attempt to carry out any service or maintenance with wet hands or while the appliance is wet.
- Clean the terminal board or the power supply socket before connection.
- For any component or sub-assembly containing a battery: do not recharge or dismantle the battery, or throw it into a fire. Do not expose it to high temperatures or direct sunlight.
- In stormy weather, unplug the appliance to prevent it from suffering lightning damage.
- Do not immerse the appliance in water (with the exception of cleaners) or mud.
- This appliance is compatible with all types of water treatment used in swimming pools. Refer to the Zodiac® warranty conditions for details of the permitted water balance values.
- Never run the pump dry or out of the water as this will invalidate the warranty.

EN

Recycling



This symbol means that your appliance must not be thrown into a normal bin. It will be selectively collected for the purpose of reuse, recycling or transformation. If it contains any substances that may be harmful to the environment, these will be eliminated or neutralised.
Contact your retailer for recycling information.



- Before handling the appliance, it is essential that you read this installation and user manual, as well as the "warnings and warranty" booklet delivered with the appliance. Failure to do so may result in material damage or serious or fatal injury and will void the warranty.
- Keep and pass on these documents for later viewing throughout the appliance's service life.
- The distribution or modification of this document in any way is prohibited, without prior authorisation from Zodiac®.
- Zodiac® is constantly developing its products to improve their quality. The information contained herein may therefore be modified without notice.

CONTENTS



1 Specifications

3

1.1 | Description

3

1.2 | Technical specifications

3

1.3 | Dimensions and marking

4

1.4 | Performance curves

4



2 Installation

5

2.1 | Selecting the location

5

2.2 | Hydraulic connections

6

2.3 | Power connections

7



3 Use

8

3.1 | Operating principle

8

3.2 | User interface presentation

8

3.3 | Operation

8

3.4 | Additional user functions

9



4 Maintenance

10

4.1 | Winterising

10

4.2 | Servicing

10



5 Troubleshooting

11

5.1 | Appliance behaviour

11

5.2 | Error codes

12



Tip: to make it easier to contact your retailer

- Write down your retailer's contact details to help you find them more easily and fill in the "product" information on the back of the manual; your retailer will ask you for this information.



1 Specifications

1.1 I Description

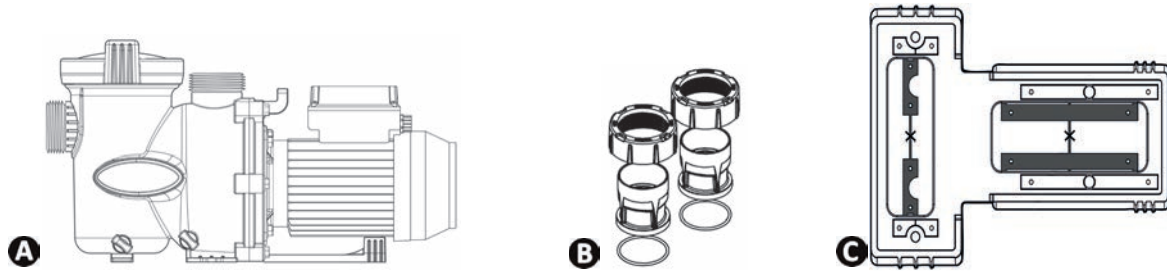

A	FloPro™ e3 pump	✓
B	Union connection Ø63/50 mm x2	✓
C	Pump base	+

EN

1.2 I Technical specifications

		Unit	FloPro™ e3
Operating water temperature			2 to 35°C
Nominal voltage of motor			230 Vac-50 Hz
Motor power - phases			1P
Admissible variation in motor voltage			± 10% (during operation)
Motor output power (P2)	HP		1
	W		750
Maximum power at motor input (P1)	W		1000
Maximum motor amperage	A		6.5
Cable cross-section	mm ²		3x1.5
	Lug type		3G1.5
Electrical protection	A		10
Primary protection			8A fuse 32x6.3mm
Motor protection rating			IPX5
Maximum pump flow	m ³ /h		22.4
Pump flow rate at 10 meters of head	m ³ /h		16.3 (at 2850 RPM)
Maximum pump pressure	mH ₂ O		19.1
	bar		1.9
Pump pipe connection			2" threaded suction/discharge Ø63/50 mm union couplings
Maximum pump salinity			6g/L (6000 ppm)

Pipes	Maximum suction rate at 1.8 metres/second	Maximum discharge rate at 2.4 metres/second
Ø 50 mm	14 m ³ /h	19 m ³ /h
Ø 63 mm	20 m ³ /h	27 m ³ /h

➤ 1.3 I Dimensions and marking

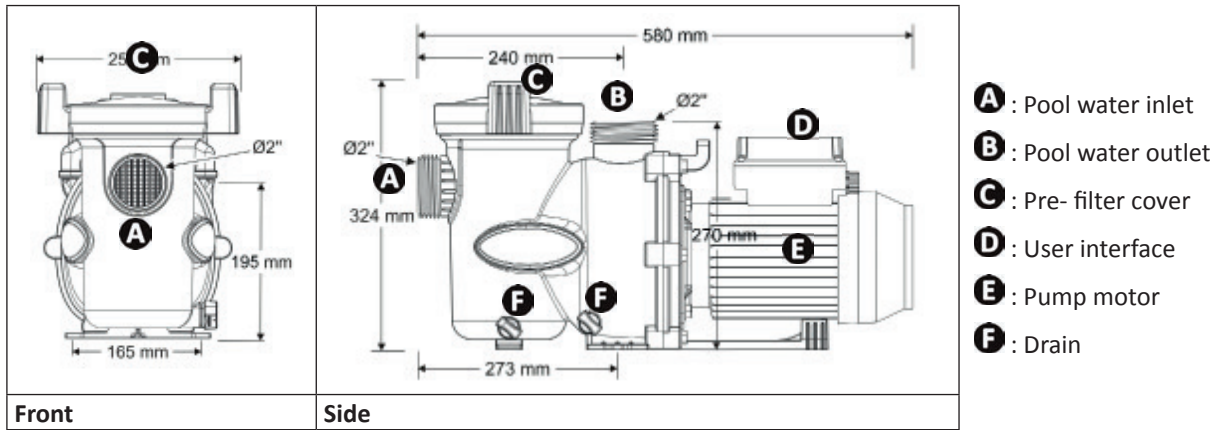

Weight: 10 Kg

➤ 1.4 I Performance curves

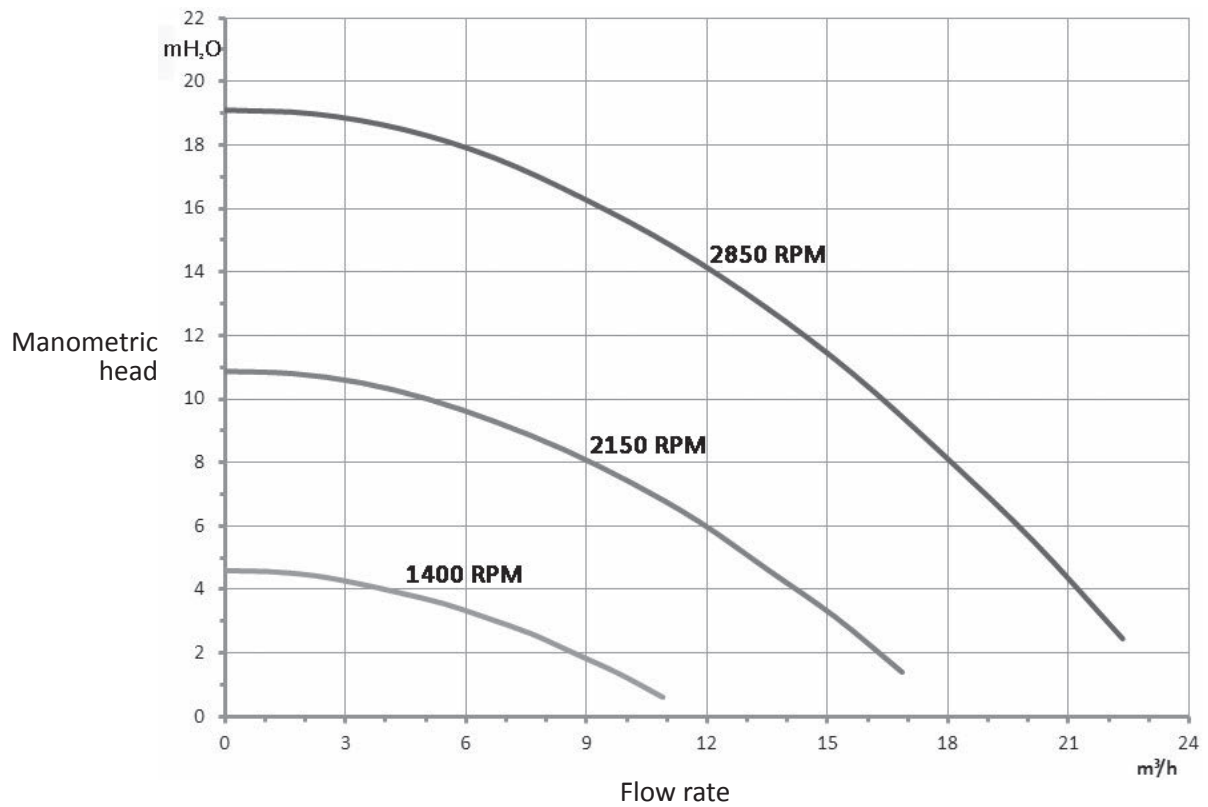



2 Installation

2.1 I Selecting the location

- The pump must be installed:
 - before the filter, a heating and/or water treatment system,
 - at a minimum distance of 3.5 metres from the edge of the pool, to avoid any water being sprayed onto the appliance. Some standards allow for other distances. Refer to the regulations in effect in the country of installation.
 - ideally 30 cm below the water level,
 - out of an area subject to flooding, or on a base with drainage,
 - in a ventilated area to allow the pump and motor to cool.
- The pump must not be installed:
 - in an area subject to splashing or rain.
 - more than 1 m above the water level.
 - near a heat source or source of flammable gas.
 - in an area that cannot be cleaned or kept free of leaves, dry foliage, and other potentially flammable items.
- Easy access is required for maintenance work on the appliance.
- Place on a stable, level and solid surface (e.g. concrete floor).
- If necessary, use the bases (2 types of base, not supplied, available as an option) to raise the pump to the level of the existing pipes.
- Anchor the pump to the ground using the adapted foundation bolt.

EN

2.2 I Hydraulic connections



- Respect the direction of hydraulic connection (see § “1.3 I Dimensions and marking”).

- Choose the dimension of the pipes according to the size of the pool and respecting the hydraulic rules which apply in the country of installation.
- Performance curves are available in § “1.4 I Performance curves” for the pipe dimensions.
- For hydraulic connections, use the Ø63/50 mm union couplings via bonding (provided) or the 2” threaded PVC couplings directly screwed onto the pump.
- Fit a check valve if the filter is installed above the water level.
- Fit suction and discharge isolation valves if the pump is installed below the water level.
- To help prevent difficulty in priming, install the suction pipe without high points, which can trap air.
- Check that the hydraulic connections are correctly tightened and that there are no leaks.
- The pipes must be supported to prevent any risk of breakage due to the weight of the water.

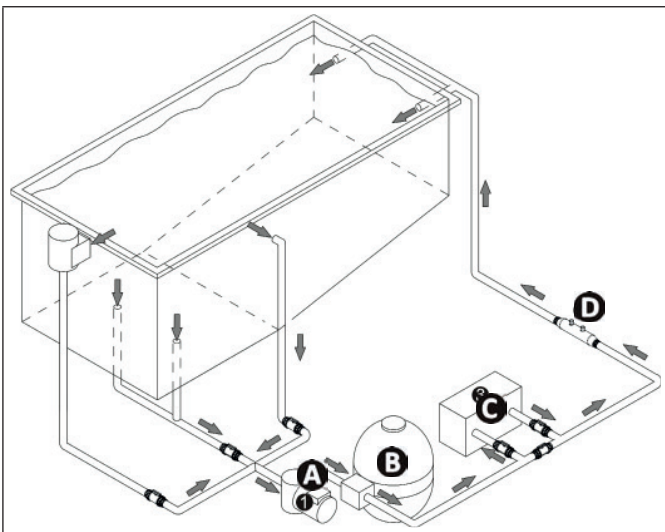

- A**: pump
- B**: filter
- C**: heating system
- D**: water treatment system

- Use as few elbow joints as possible. If there needs to be more than 10 elbow joints on the hydraulic circuit, increase the pipe diameter.

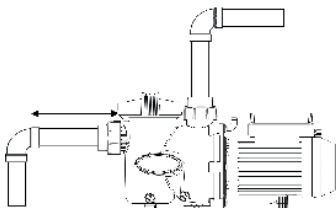

- Suction pipe length = $4 \times \varnothing$

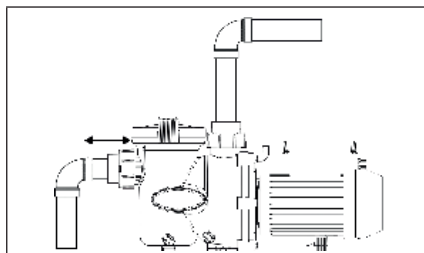

- Suction pipe too short
- Risk of cavitation

- Air retention
- Risk of incorrect pre- filter filling

2.3 I Power connections



- Before any work on the appliance, you must disconnect the electricity supply to avoid the risk of electric shock which may cause material damage, serious injury or even death.
- Only a qualified and experienced technician is authorised to carry out any service, including cabling work within the appliance or to replace the power cord.
- To prevent overheating of the terminal board, which could create a fire hazard, check that all terminals have been properly tightened. Loose terminals will void the warranty.
- The appliance must be connected to the earth.
- Any unsuitable electrical connection will invalidate the warranty.

- The appliance's electrical supply must be provided through a protection and circuit breaking device (not supplied) complying with the standards and regulations in force in the country in which it is installed.
- Electrical protection: by circuit breaker (D curve), with a 30 mA dedicated differential circuit breaker (circuit breaker or switch) at the head of the line.
- The power supply must correspond to the voltage indicated on the appliance's information plate.
- The power cord must be insulated and protected against abrasions and damage.
- Use the gland to pass the power cord into the appliance.
- The appliance and the swimming pool and any other electrical equipment must be connected to the earth.

EN

2.4.2 Power supply and clock

Connect the pump to the contactor downstream of the swimming pool switch box's filtration clock. The filtration unit clock directly controls the pump's electricity supply, which then starts.

2.4.3 Connecting the motor's power supply

- Open the electrical connection box by unscrewing the 3 screws on the user interface and tilting it to the side (pay attention to the wires underneath).
- Disconnect and remove the factory test power wires exiting the connection box where necessary.
- Run the power cord through the gland and connect it to the terminals in accordance with the power supply:

230 Vac - 50 Hz power supply = connection to the  (earth) and N-L terminals.

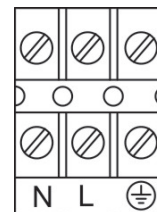

- Close the electrical connection box, making sure that the seal is on place and tighten the 3 screws.







3 Use

3.1 I Operating principle

The filtration pump forms the core of the pool and is essential as it is used to circulate water through the pool's different components, in particular the filter.

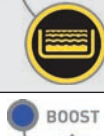
Its motor drives the turbine in rotation, which drives the water. The large strainer of the pre- filter collects major debris to prevent the filter from becoming clogged too quickly or from becoming damaged.

3.2 I User interface presentation

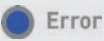
Symbol		Designation
	Key	"ECO" speed activation Speed reduction in setting mode
	LED	Flashing: in priming mode (approx. 2 minutes on start-up) Fixed: speed in operation
	Key	"CLEAN" speed activation Recording of the current setting (press for 10 seconds)
	LED	Flashing: in priming mode (approx. 2 minutes on start-up) Fixed: speed in operation
	Key	"BOOST" speed activation Speed increase in setting mode
	LED	Flashing: in priming mode (approx. 2 minutes on start-up) Fixed: speed in operation
	Key	Shutdown of the speed during operation
	LED	Flashing: pump stopped, powered up Fixed: pump in operation
	LED	The number of flashes indicates the error in progress

3.3 I Operation





- To prevent against any risk of explosion that may cause material damage, serious injury or even death, make sure that the hydraulic circuit is free of any debris or blockage and is not subject to excessive pressure.
- Never run the pump "dry" as this may damage it.
- The pre- filter strainer cover must be closed by hand (do not use any tools).

- Check that the hydraulic connections are correctly tightened.
- Check that the pump is stable and level.
- The hydraulic circuit must be bled and not contain any foreign bodies.
- The pump pre- filter strainer cover must be correctly closed (by hand) and its gasket clean and in place.
- Check that the valves are open.
- Start up the pump by activating a speed. The pump always starts in "priming" mode (2850 rpm for approx. 2 minutes).
- The pump is self-priming. However, you are strongly recommended to fill the pre- filter strainer with water before starting it up for the first time to facilitate the procedure.
- The pump has a priming capacity up to 3 metres above the swimming pool water level and at sea level elevation (if the hydraulic circuit is perfectly sealed).
- Bleed any air present in the filtration circuit using the bleed normally present on the filter (refer to the swimming pool filter's manual).
- Check that there are no leaks on the hydraulic circuit.

▶ 3.4 I Additional user functions

3.4.1 Using speeds

Speed	Keys to start the speed	Default speed
"ECO" speed		1400 rpm
"CLEAN" speed		2150 rpm
"BOOST" speed		2850 rpm
"PRIMING" speed	Automatic at start-up	2850 rpm for 2 minutes

- When the pump is running, it displays the operating speed and an LED lights up above the key which corresponds to the speed.





If the mains supply is disconnected (manually or via the filtration clock) the pump will restart at the last speed active.

EN

3.4.2 Modifying the speed configuration

- the speed you want to modify must be operating,
- press the key that corresponds to this speed for 5 seconds (the corresponding LED must flash).

- press  or  until you reach the speed you want (increments of 50 rpm).
- Press  and hold for 10 seconds to save.



3.4.3 Pump shutdown

- Press .

3.4.4 Pump reset

You may reset the pump to return it to "factory" configuration:

- make sure that the pump is powered up but stopped ("OFF" is displayed on the screen).

- press  +  +  for 5 seconds until the 3 corresponding LEDs flash once.

- release the keys: the pump is now reset.



4 Maintenance

➤ 4.1 | Winterising



- **The pump must be fully wintered in the event of a risk of frost or extended electrical disconnection. If the pump freezes it may cause severe damage and invalidate the warranty.**
- **To avoid damaging the appliance with condensation, do not fully cover it.**

- If the pump is positioned below the water level, close the isolation valves at suction and discharge.
- Drain the pump (using the 2 bleed screws) and the hydraulic circuit, following the swimming pool manufacturer's instructions.
- Remove the 2 bleed screws and keep them to reinstall them when the pump is put back into operation.
- You are recommended to disconnect the electrical power cable then unscrew the hydraulic connectors to store the pump in a dry place away from frost.
- Store the pump in a dry environment at a temperature that varies as little as possible to prevent condensation which would damage the pump.

➤ 4.2 | Servicing



- **It is recommended that the appliance undergo general servicing at least on a yearly basis to ensure proper operation, maintain performance levels and potentially prevent certain failures. These operations are carried out at the user's expense and certain operations must be performed by a technician.**

4.2.1 User maintenance

- Make sure that the pump and electrical compartment contain no foreign bodies.
- Clean the outside of the appliance, do not use solvent-based products.
- Clean the pre- filter strainer, the cover and the gasket regularly.
- Check that the pre- filter strainer is correctly in place, or it may prevent the cover from closing fully.

4.2.2 Maintenance to be carried out by a qualified technician

- Check the connection of the metal masses to the earth.
- Check that the electrical cables are correctly tightened and connected and that the switch box is clean.
- Check that the user interface is correctly connected.



5 Troubleshooting



- If a problem occurs, before you contact your retailer, please carry out these few simple checks using the following tables.
- If the problem continues, contact your retailer.
- : Actions to be performed by a qualified technician only

5.1 I Appliance behaviour

<p>The pump does not start / the motor does not turn.</p>	<ul style="list-style-type: none"> • Filtration outside of a scheduled operating range ("Auto" mode). Check the filtration clock settings. • Faulty user interface fuse, replace. • Electric power cut. Check the circuit breaker(s). • Check the connection between the power cable and the motor terminals. • Check that the user interface cable is not damaged. • The "error" light flashes, see § "5.2 I Error codes" • Check that the motor shaft rotates freely. Check that there is no debris in the pre- filter strainer. • If debris remains, remove the pump to access the turbine.
<p>The pump doesn't prime / air can be seen in the pre- filter strainer.</p>	<ul style="list-style-type: none"> • Check the position of all valves in the hydraulic circuit. • Air is stuck in the circuit, drain the hydraulic circuit (drain screw on the filter). • The pool's water level is too low, air is being sucked into the circuit, fill the pool. • The gasket of the pre- filter strainer lid is defective, check the condition of the gasket and the correct air-tightness of the lid.
<p>Low flow rate / low filter pressure</p>	<ul style="list-style-type: none"> • Pre- filter basket full of debris: clean. • Air leak in the circuit. Check all tightening torques. • The turbine and the pump diffuser are blocked or worn, replace. • The diffuser seal is worn, replace.
<p>Low flow rate / high filter pressure</p>	<ul style="list-style-type: none"> • The filter is clogged. Wash the filter (or the cartridge depending on the case). • Check the position of all valves in the hydraulic circuit.
<p>Pump making a lot of noise</p>	<ul style="list-style-type: none"> • Air leak or cavitation in the suction piping. Check the position of the valves and adjust where necessary. • Pump incorrectly positioned on the ground. Check that it is resting in a flat position on a hard, horizontal ground. Use anti-vibration studs where necessary. • A foreign body is present in the pre- filter strainer. • A foreign body is present in the pump body (in this case, the pump must be removed).
<p>Leak between the pump body and the motor</p>	<ul style="list-style-type: none"> • The mechanical lining is damaged or defective, replace
<p>The pump heats up and switches off</p>	<ul style="list-style-type: none"> • The motor is overheating due to too little ventilation. Check that there is enough clear space around the motor. • There is an electrical fault. Check the power connections and check the mains voltage, which must not vary.
<p>There is no damage to the user interface</p>	<ul style="list-style-type: none"> • The cable(s) is(are) damaged or poorly connected in the user interface housing; check the condition of these cables.

5.2 I Error codes

Number of flashes	Malfunction	Possible causes	Solutions
1	User interface is defective	<ul style="list-style-type: none"> The user interface resets itself constantly 	<ul style="list-style-type: none"> Check the electrical connections inside the user interface housing. Replace the motor - interface assembly if necessary.
2	Network sub-voltage	<ul style="list-style-type: none"> The network voltage has fallen below 180VCA. 	<ul style="list-style-type: none"> The interface will reset when the voltage rises over 209VCA again for at least 6 seconds
3	temperature	<ul style="list-style-type: none"> Motor temperature too high (+100°C) Motor temperature too low (-20°C) 	<ul style="list-style-type: none"> Wait until normal temperature conditions return and restart the pump.
4	Surge activation	<ul style="list-style-type: none"> The surge protection has been activated 	<ul style="list-style-type: none"> Check the electrical supply. Restart the pump.
5	Network overvoltage	<ul style="list-style-type: none"> The voltage exceeds 269VCA 	<ul style="list-style-type: none"> The interface will reset when the voltage returns to a normal value.
6	Motor shaft jammed	<ul style="list-style-type: none"> Motor start-up impossible The motor has stopped 	<ul style="list-style-type: none"> Break the pump circuit and check that no debris is blocking the turbine (remove the pre- filter screen). Check that there is no debris blocking the rear fan.
7	Automatic verification	<ul style="list-style-type: none"> At least one of the automatic tests failed on start-up or during operation 	<ul style="list-style-type: none"> Break the pump circuit then reconnect it to reset it.
8	Motor fault	<ul style="list-style-type: none"> At least one of the phases is disconnected 	<ul style="list-style-type: none"> Check the electrical connections inside the user interface housing.

Votre revendeur
Your retailer

Modèle appareil
Appliance model

Numéro de série
Serial number

Trouvez plus d'informations et enregistrez votre produit sur
More informations and register you product on

www.zodiac-poolcare.com

