

CONTROL BASIC PLUS **ASTRALPOOL**

INSTRUCTIONS MANUAL **EN**

HANDBUCH **DE**

MANUAL DE INSTALACION **ES**

MANUEL D'INSTALLATION **FR**

MANUALE D'INSTALLAZIONE **IT**

MANUAL DE INSTALAÇÃO **PT**

CONTROL BASIC PLUS **ASTRALPOOL**

PACK CONTENTS

- A) "Basic **ASTRALPOOL**" pH / REDOX control device
- B) PVC Crystal 4x6 with suction device (2 m)
- C) Polyethylene delivery hose (3m)
- D) Attachment screw ($\phi=6$ mm)
- E) Foot filter (PVC riser)
- F) FPM duckbill valve (3/8" GAS)
- G) ModBus connector

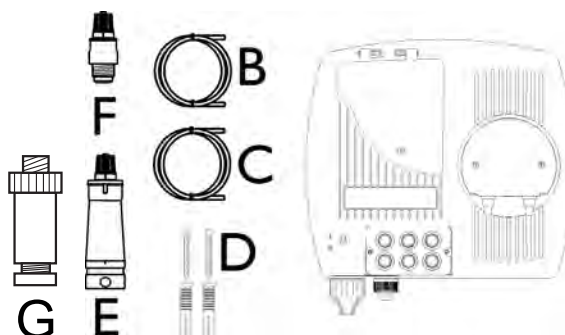

TECHNICAL SPECIFICATIONS

Dimensions (H – W – L)	234x162x108 mm
Weight	1 kg
Power supply 50 Hz	230 VAC
Consumption	12 W or 18 W
Pump flow rate	1,5 l/h; 5 l/h
Maximum back-pressure	1,5 bar
Pump state	Pause - Supply
Measure scale	0 ÷ 14.0 pH; Redox 0÷ +1000 mV
Device precision	± 0,1 pH; ± 10 mV
Device accuracy	± 0,02 pH; ± 2 mV
Electrode regulation	Automatic

Wall Mounting Setup

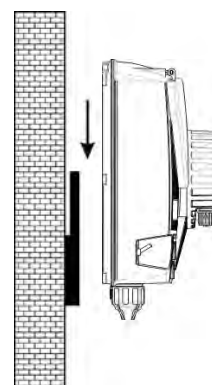

ATTENZIONE / WARNING / ATTENTION / ACHTUNG

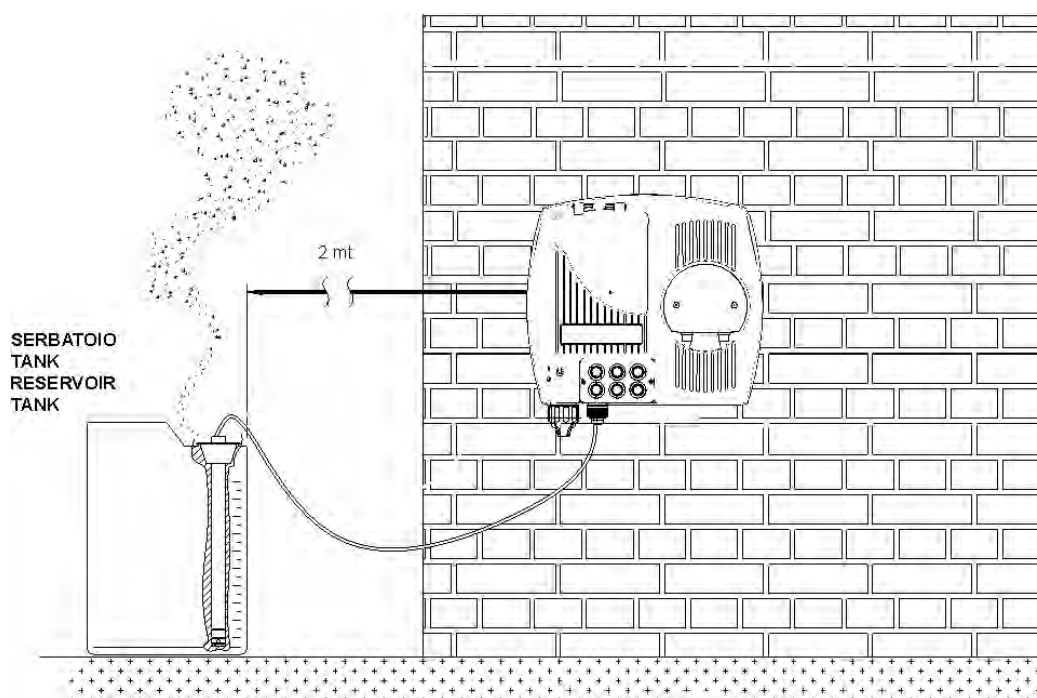



Instruction Setting

Functions:

- **Calibration**

- (Press  for 3 Seconds):
- Standard Routine calibration for 7 and 4 buffer solution

- **Set Point**

- Press 
 - Keep Press Set Key and adjust value with 
 - **SP_7.4PH**

- Press  for 5 Seconds and run Program Setup:

- **PROGRAM**

- Press  to set the following Item

- **PUMP CONFIG.**

- Adjust  pH or Redox

- **LANGUAGE**

- (It's possible to have 5 language EN, IT, SP, DE, FR)

- **DOSAGE TYPE**

- Adjust value with  and 
 - It's possible to adjust value between PROP or ON/OFF

- **FLOW**

- Adjust value with  and 
 - It's possible to enable(ON) or disable (OFF) signal input

- **RS485 SETTINGS**

Press  to set the following Item

- **RS-485**



- Adjust value with  and 



- It's possible to enable(ON) or disable (OFF) the communication.

- **WDG CONFIG.**
 - Adjust value with  and 
 - It's possible to set as: Hardware Reset, Com. Reset, Stop Dosage and WDG Alarm (default value).



- **RS485 WATCHDOG**
 - Adjust value with  and 
 - It's possible to adjust the time in seconds. If it is set as OFF (default value) the communication watchdog is disabled.



- **ADDRESS**
 - Adjust value with  and 
 - It's possible to adjust the address of the device from 1 (default value) to 247

- **PARITY**
 - Adjust value with  and 
 - The value of the parity bit, it's possible to set as: Even (default value), Odd or No.



- **BAUDRATE**
 - Adjust value with  and 
 - The value of the speed of the transmission, it's possible to set as: 2400, 4800, 9600 (default value), 19200.
 -

- **SETPOINT 7.4PH**
 - Adjust value with  and 
 - It's possible to adjust from 0 to 14 pH value and 0 to 1000 mV for Redox



- **SETPOINT TYPE ACID**
 - Adjust value  and 
 - It's possible to adjust Acid or Alkaline dosing and High or Low for Redox

- **OFA TIME OFF**
 - Adjust value  and 
 - It's possible to adjust OFA time in minutes

○ CALIBRATION 7/4PH



- Adjust value  and 
- It's possible to select 2 points 7 and 4 pH, 1 point only 7pH or function disable; for Redox function disable only.

○ MAN TEMPERATURE 25°C

- Adjust value  and 
- pH measure only.

- Save and escape Program setup with ESC key

○ EXIT SAVE

- Adjust value with  up or down key and confirm with 

○ PRIMING

- Priming Pump Keep Press  for 3 seconds

Wire Connection:



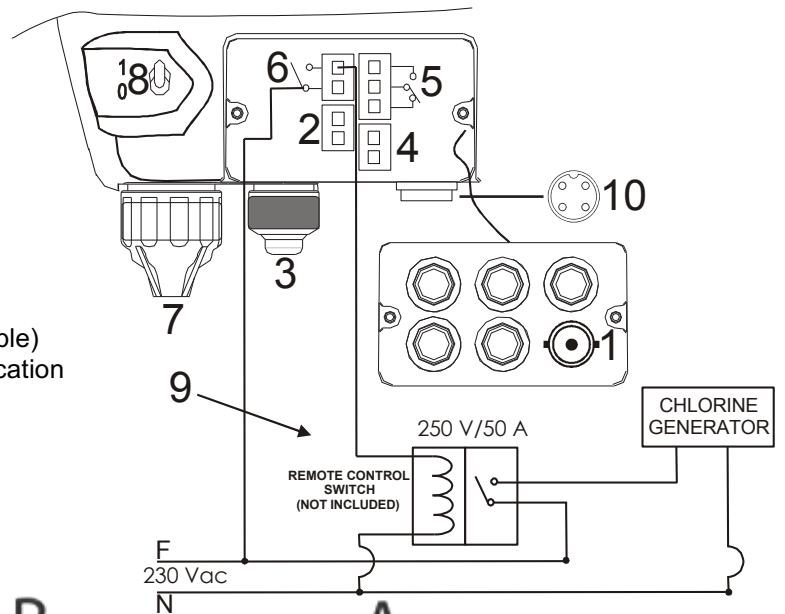



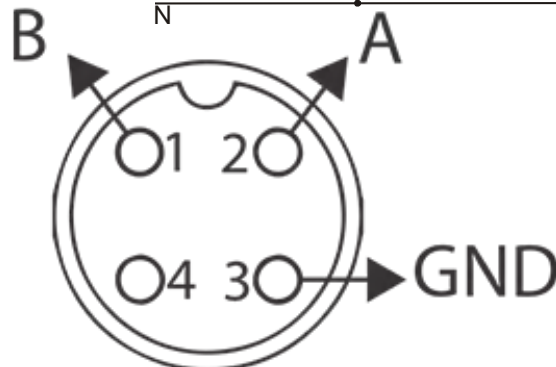



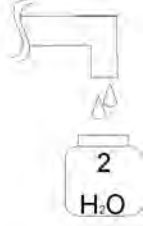

- 1) Input pH or Redox Probe
- 2) Input Temperature Probe (PT100)
- 3) Input Level Probe (Product Tank)
- 4) Input Flow Rate (High Voltage 230 Vac)
- 5) Output Relay Alarm remote (Dry contact, Relay 250 Vac 10 A)
- 6) Output Relay Drive Solenoid Valve (Dry contact, Relay 250 Vac 10 A)
- 7) Power Supply 230 Vac
- 8) Switch Power Supply
- 9) Connection to a chlorine generator (example)
- 10) Port connection for the ModBus communication



ModBus connction	
Pin N°	Description
1	T+R+ (B)
2	T-R- (A)
3	GND
4	Not used









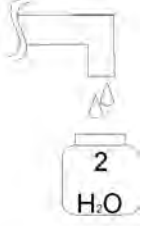

pH Probe Calibration

<p>①</p> 	<p>②</p> 	<p>③</p>  <p>Wash</p>
<p>④</p>  <p>Keep probe into Buffer solution</p>	<p>5</p> <p>CALIBRATION</p>  <p>Press Cal Key 3 Seconds</p>	<p>6</p> <p>7PH__PRESS_CAL</p>  <p>Calibration During 1 minutes</p> <p>WAIT_____60S</p>
<p>7</p> <p>7PH_QUALITY_100%</p> <p>Quality Probe</p>	<p>⑧</p>  <p>Wash</p>	<p>⑨</p>  <p>Keep probe into Buffer solution</p>
<p>10</p> <p>4PH__PRESS_CAL</p>  <p>Calibration During 1 minutes</p> <p>WAIT_____60S</p>	<p>11</p> <p>4PH_QUALITY_100%</p> <p>Quality Probe</p>	<p>⑫</p>  <p>Wash</p>
<p>⑬</p> 	<p>14</p>  <p>Press Enter Key to save and exit</p>	<p>15</p> <p>Normal Status</p>

Note:

If you have setting Calibration = 7 pH the function has 1 point calibrate only 7 pH buffer solution.

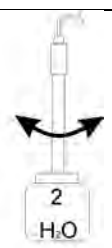
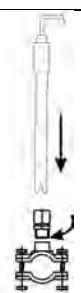
Redox Probe Calibration

<p>①</p> 	<p>②</p> 	<p>③</p>  <p>Wash</p>
<p>④</p>  <p>Keep probe into Buffer solution</p>	<p>5</p> <p>CALIBRATION</p>  <p>Press Cal Key 3 Seconds</p>	<p>6</p> <p>465mV__PRESS_CAL</p>  <p>Calibration During 1 minutes</p> <p>WAIT_____60S</p>
<p>7</p> <p>465mV_QUALITY_100%</p> <p>Quality Probe</p>	<p>⑧</p> 	<p>⑨</p> 
<p>10</p>  <p>Press Cal Key 3 Seconds</p>	<p>11</p> <p>Normal Status</p>	

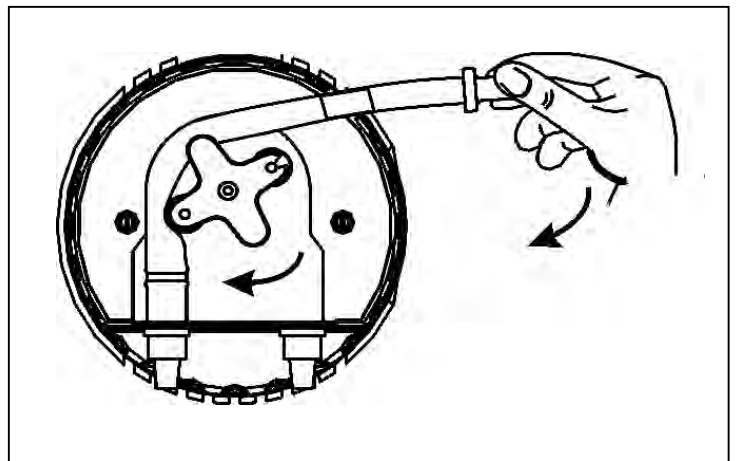
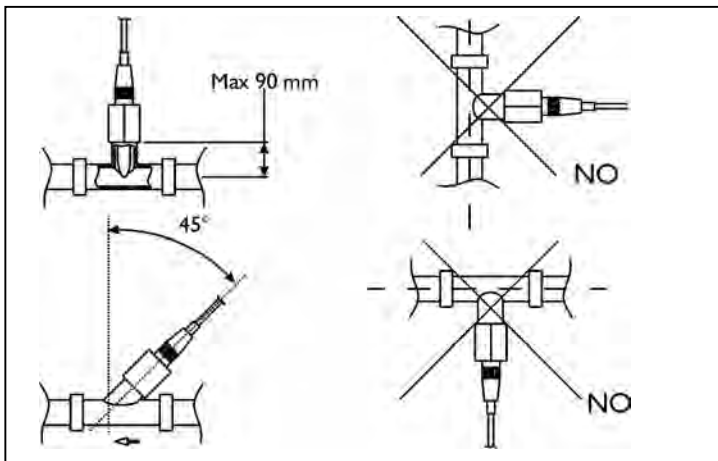
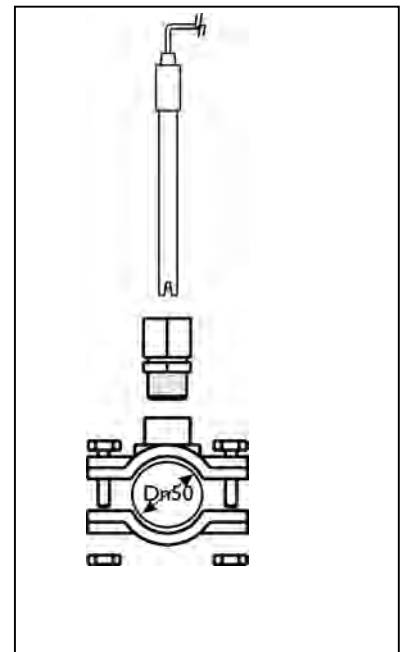
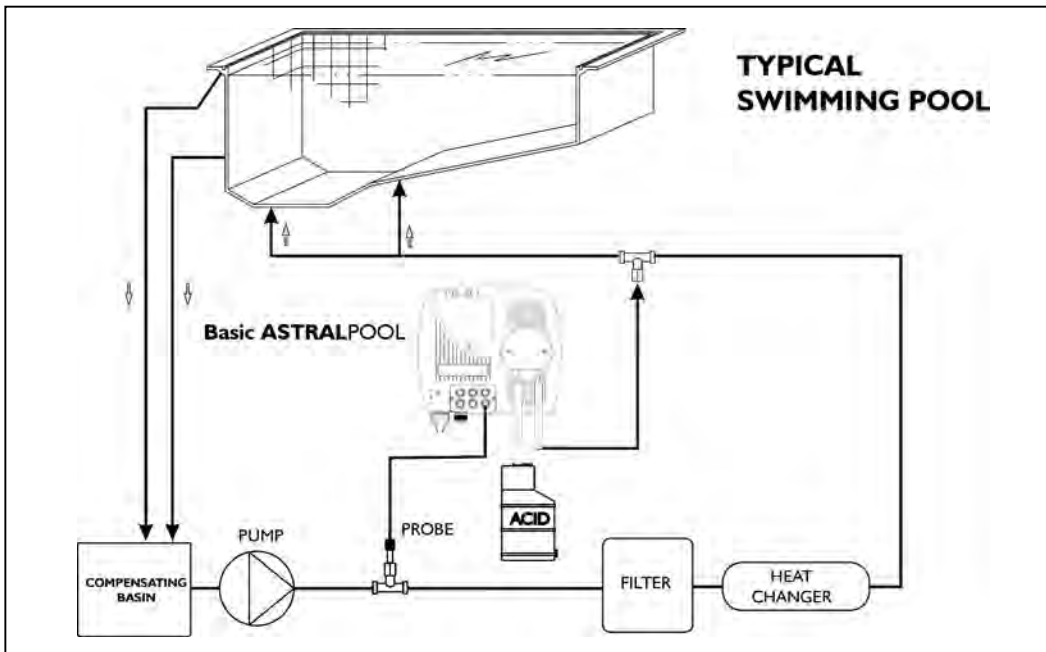

Alarm	Display	Relay	Actions to do
Level	LEVEL___7,2_PH	Alarm Relay Close	- Push Enter Key to open Alarm Relay - Restore Product tank
OFA First Alarm (time >70%)	OFA_ALARM__7,2_PH	Alarm Relay open	- Push Enter Key to reset
OFA Second Alarm (time =100%)	OFA_STOP__7,2_PH	Alarm Relay Close	- Push Enter Key to reset
Flow Rate	FLOW_____7,2_PH	Alarm Relay open	- Restore Flow Rate
System Error	PARAMETER_ERROR	Alarm Relay Open	- Press Enter Key to replace Default parameter
Communication Watchdog alarm	WDG_ALARM	Alarm Relay Close	- Check the communication network
Calibration Function	ERROR_7_PH ERROR_4_PH ERROR_465_MV	Alarm Relay open	- Restore Probe or Buffer solution and repeat calibration function

Default parameters:

- Language = UK
- Set Point value= 7,4 pH; 750mV (Rx)
- Dosing Method = Acid; Low (Rx)
- Time OFA = OFF
- Calibration = 7/4 (2 point); 465mV (Rx)
- Flow Input = OFF

To restore Default parameters run Following steps:

- Power off Pool Basic unit
- Keeping Press UP and DOWN Key switch on the Power.
- The unit will flash INIT.DEFAULT__NO
- Press up INIT.DEFAULT__YES
- Enter Key to restore Default parameters.

CONTROL BASIC PLUS **ASTRALPOOL**

Verpackungsinhalt

- A) "Basic **ASTRALPOOL**" pH / REDOX Kontrollsystem
- B) PVC-Schlauch Crystal 4x6 (2 m)
- C) Polyethylen-Schlauch (3 m)
- D) Schrauben mit Dübeln ($\phi = 6$ mm)
- E) Fußfilter (PVC)
- F) Rückschlagventil aus FPM (3/8" GAS)
- G) ModBus-Anschluss

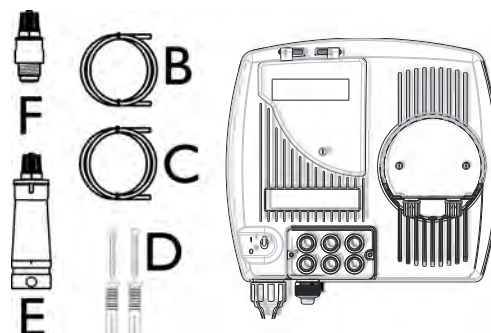

TECHNISCHE DATEN

Abmessungen (H - B - T)	234x162x108 mm
Gewicht	1 kg
Spannungsversorgung	230 Vac
Verbrauch	12 W oder 18 W
Förderleistung der Pumpe	1,5 l/Std.; 5 l/Std.
Max. Gegendruck	1,5 bar
Pumpenstatus	Pause - Betrieb
Messkala	0 ÷ 14.0 pH; Redox 0 ÷ +1000mV
Messgenauigkeit	$\pm 0,1$ pH; ± 10 mV
Genauigkeit Maß	$\pm 0,02$ pH; ± 2 mV
Kalibrierung der Elektrode	automatisch

Wandmontage

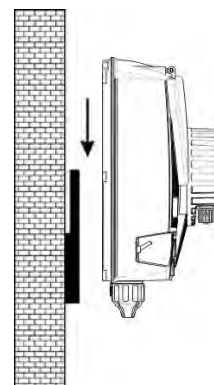

ATTENZIONE / WARNING / ATTENTION / ACHTUNG

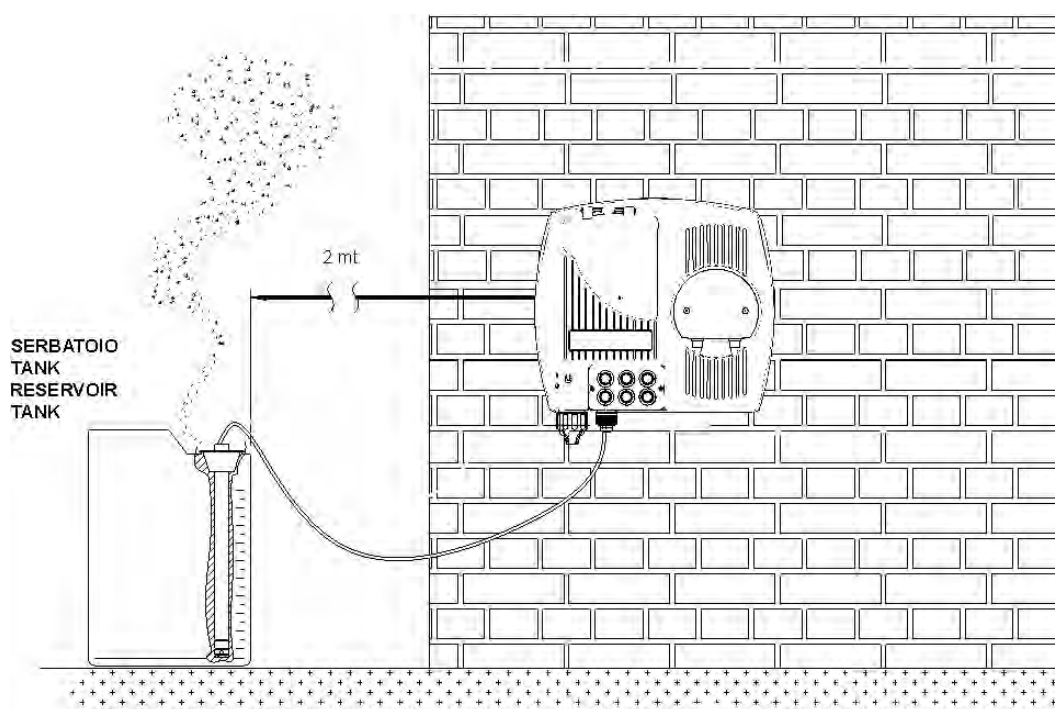



Einstellungen

Funktion:



- **Kalibrierung**

- 3 Sekunden lang die Taste  drücken
 - Standardabfolge der Kalibrierung für Pufferlösung mit pH-Wert 7 und 4.

- **Set Point**

- Taste  drücken
 - Die Taste Set Key gedrückt halten und den Wert über die Tasten  verändern.

- **SP_7.4PH__**

- Die Tasten   (zusammen) 5 Sekunden lang gedrückt halten, um in das Konfigurationsmenü zu gelangen:

- **PARAMETER**

-  drücken, um die folgenden Punkte einzustellen
- **KONFIG_PUMPE**
 - (pH oder Redox wählen)
- **SPRACHE**
 - (Es können 5 Sprachen eingestellt werden EN, IT, SP, DE, FR)

- **DOSIERUNG TYPE**

- Über die Tasten  auswählen
- Es ist möglich, Wert zwischen PROP oder ON / OFF einstellen



- **FLUSS**

- Über die Tasten  auswählen
- Der Durchflusseingang (Hochspannung), der parallel zur Rückförpumpen angeschlossen ist, kann aktiviert (ON) oder deaktiviert (OFF) werden.

- **RS485 KONFIGURAT**

- Drücken Sie  die folgenden Artikel einstellen

- **RS-485**



- Stellen Sie Wert mit  und 
- Es ist möglich, zu aktivieren (ON) oder deaktiviert (OFF), um die Kommunikation

- **W06 CONFIG.**



- Stellen Sie Wert mit  und 

- Es ist möglich, wie zu setzen: Hardware-Reset, Com. Reset, Stop Dosierung und WDG Alarm (Standardwert).



▪ RS485 WATCHDOG

- Stellen Sie Wert mit  und  ein
- Es ist möglich, die Zeit in Sekunden einzustellen. Wenn es als OFF (Standardwert)

▪ ADRESSE

- Stellen Sie Wert mit  und  ein
- Es ist möglich, die Adresse des Geräts von 1 (Standardwert) bis 247 einzustellen



▪ PARITÄT

- Stellen Sie Wert mit  und  ein
- Der Wert des Paritätsbits, dann ist es möglich, zu setzen: Auch (Standardwert), Odd oder Nein.



▪ BAUDRATE

- Stellen Sie Wert mit  und  ein
- Der Wert der Geschwindigkeit des Getriebes ist es möglich, wie zu setzen: 2400, 4800, 9600 (Standardwert), 19200.



○ SOLLWERT ____ 7.4PH

- Über die Taste  auswählen und über  einstellen
- Der Wert kann zwischen 0 und 14 pH oder für Redoxmessungen zwischen 0 und +1000 mV verändert werden.



○ SOLLWERT TYP__SAURE

- Über die Taste  auswählen und über  einstellen
- Kann zur Dosierung einer alkalischen oder einer sauren Lösung oder für Redox auf High oder Low gestellt werden.



○ OFA ZEIT ____ OFF

- Über die Taste  auswählen und über  einstellen
- Hier kann die OFA-Zeit (Zeit der Überdosierung in Minuten) verändert werden.
-

○ KALIBRATION__ 7/4PH



- Über die Taste  auswählen und über  einstellen
- Die Abfolge der Kalibrierung kann auf 2 Punkte (7 und 4 pH), oder nur auf 1 Punkt (nur 7 pH) eingestellt oder die Funktion deaktiviert werden; für Redox haben wir 465 mV oder Funktion deaktiviert.

○ TEMPERATUR MAN_25°C

- Über die Taste  auswählen und über  einstellen
- Der Temperaturwert kann manuell eingegeben werden (nur bei der pH-Messung)

- Speichern und das Programm über die Taste ESC verlassen.

○ VERLASSEN__ SICHERN

- Über die Taste  auswählen und über  einstellen

○ ANSAUGUNG__

- Für die Funktion manuelles Ansaugen die Taste  3 Sekunden lang gedrückt halten

Anschluss der Kabel



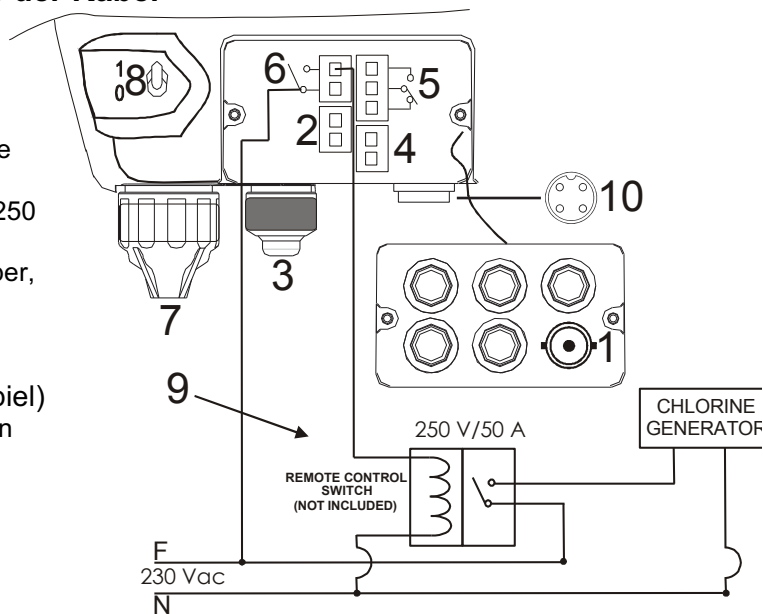



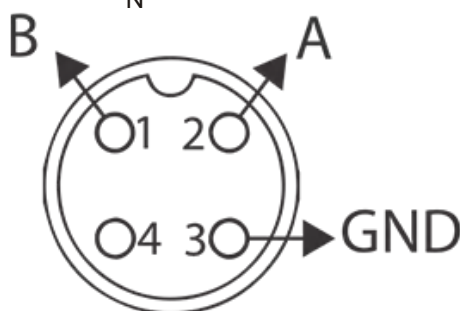



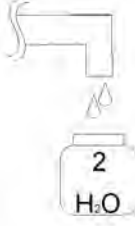

- 1) Eingang pH- oder Redoxfühler
- 2) Eingang Temperaturfühler (PT100)
- 3) Eingang Füllstandssonde (Produkt im Produkttank)
- 4) Durchflusseingang, Durchfluss Rückförpumppe (elektrisches Signal 230 Vac)
- 5) Ausgang Alarmrelais (Kontakt sauber, Relais 250 Vac, 10 A Widerstandsbelastung)
- 6) Ausgang Relais für Elektroventil (Kontakt sauber, Relais 250 Vac, 10 A Widerstandsbelastung)
- 7) Stromversorgung 230 Vac 50 Hz.
- 8) Stromunterbrechungsschalter.
- 9) Der Anschluss an eine Chlor-Generator (beispiel)
- 10) Port-Anschluss für die ModBus-Kommunikation



Modbusanbindung	
Pin N°	Beschreibung
1	T+R+ (B)
2	T-R- (A)
3	GND
4	Nicht benutzt









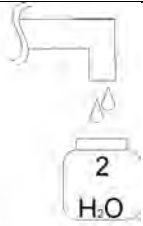

Kalibrierung der pH-Sonde

<p>① </p>	<p>② </p>	<p>③  Die Sonde spülen</p>
<p>④  Die Sonde in die Pufferlösung halten</p>	<p style="text-align: center;">KALIBRATION</p> <p style="text-align: center;"></p> <p>Die Taste KAL 3 Sekunden lang drücken</p> <p>5</p>	<p style="text-align: center;">7PH_CAL_DRUCKEN</p> <p style="text-align: center;"></p> <p>Die Kalibrierung dauert eine Minute</p> <p style="text-align: center;">BDS__PAUSE</p> <p>6</p>
<p style="text-align: center;">7PH_QUALITAT_100%</p> <p>Qualität der Sonde</p> <p>7</p>	<p>⑧  Die Sonde spülen</p>	<p>⑨  Die Sonde in die Pufferlösung halten</p>
<p style="text-align: center;">4PH_CAL_DRUCKEN</p> <p style="text-align: center;"></p> <p>Die Kalibrierung dauert eine Minute</p> <p style="text-align: center;">BDS__PAUSE</p> <p>10</p>	<p style="text-align: center;">4PH_QUALITAT_100%</p> <p>Qualität der Sonde</p> <p>11</p>	<p>⑫  Die Sonde spülen</p>
<p>⑬ </p>	<p style="text-align: center;"></p> <p>Die Taste Key drücken, um die Kalibrierung zu verlassen und die Daten zu speichern</p> <p>14</p>	<p>Normaler Mess- und Kontrollstatus</p> <p>15</p>

Hinweis:

Wenn wir die Funktion Kalibrierung = 7 pH einstellen, führt das System die Kalibrierung nur für den Punkt 7 pH aus.

Kalibrierung der Redox-Sonde

<p>①</p> 	<p>②</p> 	<p>③</p>  <p>Die Sonde spülen</p>
<p>④</p>  <p>Die Sonde in die Pufferlösung halten</p>	<p>KALIBRATION</p>  <p>Die Taste Kal 3 Sekunden lang drücken</p>	<p>465mV_CAL_DRUCKEN</p>  <p>Die Kalibrierung dauert eine Minute</p> <p>60S___PAUSE</p>
<p>⑦</p> <p>465mV_QUALITAT_100%</p> <p>Qualität der Sonde</p>	<p>⑧</p>  <p>Die Sonde spülen</p>	<p>⑨</p> 
<p>⑩</p>  <p>Die Taste Kal 3 Sekunden lang drücken</p>	<p>⑪</p> <p>Normaler Mess- und Kontrollstatus</p>	

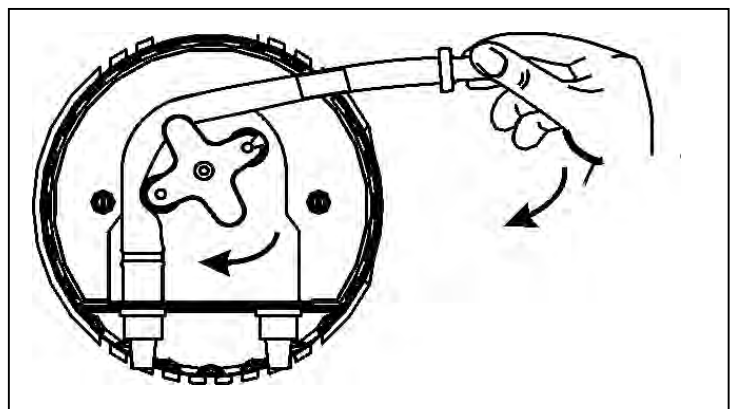
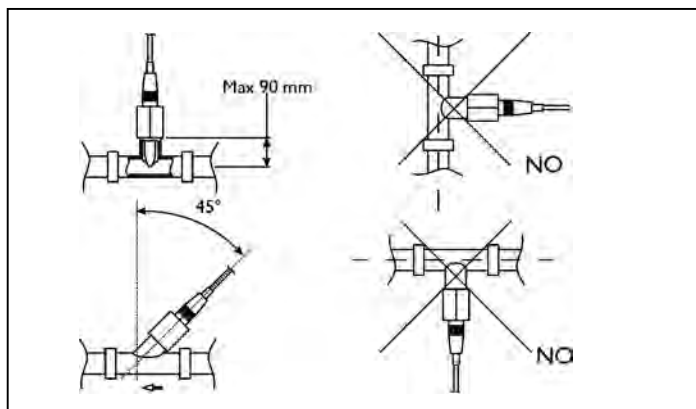
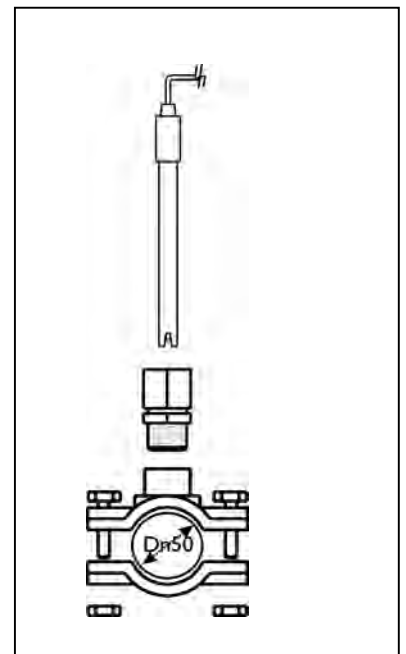
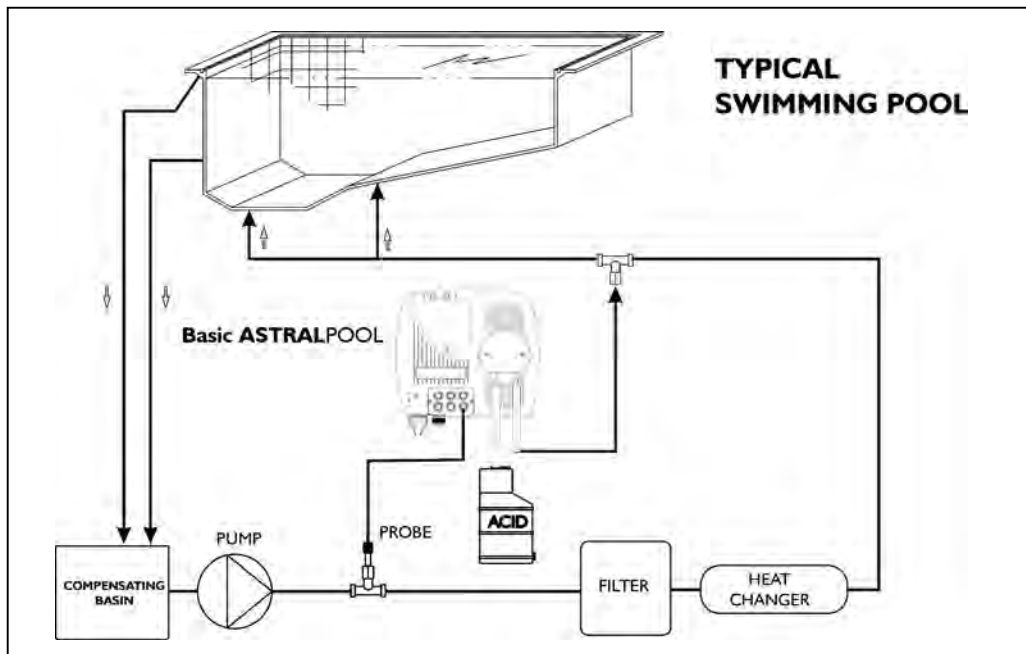

Alarm	Display	Relais	Was ist zu tun
Füllstandsalarm	FULLSTAND__7,2_PH	Alarm Relais geschlossen	- Die Taste Enter drücken, um den Alarm auszuschalten - Produkt im Produkttank auffüllen
Erster OFA-Alarm (Zeit >70%)	ALARM_OFA_7,2_PH	Alarm Relais geöffnet	- Die Taste Enter drücken, um den Alarm zu beseitigen
Zweiter OFA-Alarm (Zeit=100%)	STOP_OFA_7,2_PH	Alarm Relais geschlossen	- Die Taste Enter drücken, um den Alarm zu beseitigen
Wasserdurchfluss (Rückführungspumpe ausgeschaltet)	FLUSS__7,2_PH	Alarm Relais geöffnet	- Wasserrückführungspumpe wieder einschalten.
Systemfehler	PARAMETER_ERROR	Alarm Relais geöffnet	- Enter drücken, um die Werkseinstellungen wieder herzustellen - System kaputt
Kommunikation Watchdog Alarm	WDG_ALARM	Alarm Relais geschlossen	- Überprüfen Sie das Kommunikationsnetz
Kalibrierfunktion	FEHLER_7_PH FEHLER_4_PH FEHLER_465_mV	Alarm Relais geöffnet	- Die Sonde oder die Pufferlösung austauschen und die Kalibrierung wiederholen.

Werkparameter:

- Sprache = **UK (Englisch)**
- SetPoint Wert = **7,4 pH; 750mV (Rx)**
- Dosiermethode = **Säure; Niedrig (Rx)**
- OFA-Zeit = **OFF**
- Kalibrierung = **7/4 (2 Punkte); 465mV**
- Durchflusseingang = **OFF**
- Dosierung type=

Um die Werkseinstellungen (Default) wieder herzustellen, wie folgt vorgehen:

- Das Basic-System ausschalten
- Die Taste UP (Aufwärts) und DOWN (Abwärts) gedrückt halten und das Basic-System einschalten.
- Das System zeigt folgendes an: **INITIAL STORUNG__NO**
- UP (Aufwärts) drücken **INITIAL STORUNG__YES**
- Die Taste Enter drücken, um die Parameter wieder herzustellen.

CONTROL BASIC PLUS **ASTRALPOOL**

Contenido de la caja

- A) Controlador "Basic **ASTRALPOOL**" pH / REDOX
- B) Tubo PVC cristal 4x6 mm para aspiración (2 m)
- C) Tubo PEAD 4x6 m para impulsión (3m)
- D) Tornillos ($\phi=6$ mm)
- E) Válvula de pie (PVC)
- F) Válvula de inyección (labio) FPM (3/8" GAS)
- G) Conector ModBus

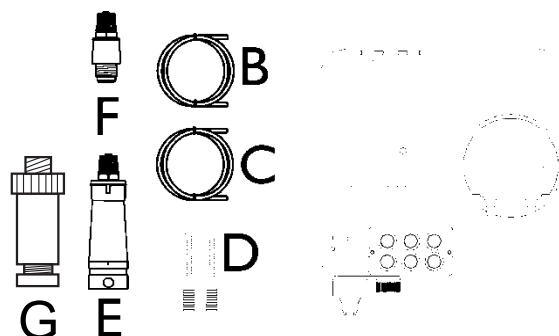

DIMENSIONES

Dimensiones (H – W – L)	234x162x108 mm
Peso	1 Kg.
Alimentación 50 Hz	230 VAC
Consumo	12 W or 18 W
Caudal de la bomba	1,5 l/h; 5 l/h
Contrapresion maxima	1,5 bar
Estado de la bomba	Pausa - Alimentación
Rango medida	0 ÷ 14.0 pH; Redox 0÷ +1000 mV
Rango control pH	0.0 pH – 14.0 pH
Precision	+/- 0,2 pH; \pm 3 mV
Regulación electrodo	Automatic

MONTAJE PARED

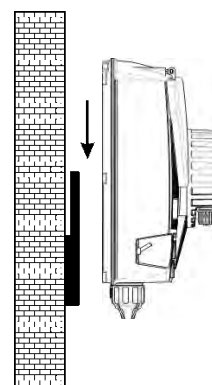

ATENCIÓN / ATTENZIONE / WARNING / ATTENTION / ACHTUNG

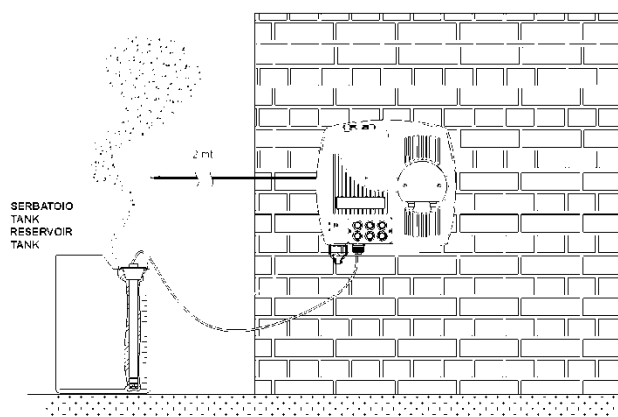



Instrucciones

Funciones:

- **Calibración**

- Presionar pulsador  durante 3 segundos
 - Rutina de calibración estándar para soluciones patrón pH 7 y pH4

- **Set Point ó Valor deseado**

- Presionar pulsador 
 - Mantener pulsado SET y con los pulsadores de subir y bajar  ajustar el valor deseado.
 - `SP_7.4PH_`

- Configuración de parámetros. Presionar juntos  durante 5 segundos



- `PROGRAMACION_CONFIGURACION`

- (Presionar  para las siguientes instrucciones)



- `CONFIG. BOMBA`

- (Ajustar con subir ó bajar  pH o Redox), pulsar  para salir



- `IDIOMA`

- Con Subir y Bajar  es posible elegir entre 5 idiomas EN, IT, SP, DE, FR
- (Ajustar con subir ó bajar pH o Redox), pulsar  para salir

- `TIPO DE DOSIS`

- Ajustar el valor con  y con los pulsadores de subir o bajar 
- Es posible ajustar el valor entre PROP o ON / OFF



- `CAUDAL`

- Ajustar el valor con  y con los pulsadores de subir o bajar 
- Es posible conectar (ON) o desconectar (OFF) la entrada de señal



- `CONFIGURAC RS485`

- Pulse  para insertar el punto siguiente



- `RS-485`

- Ajuste el valor con  y 
- Es posible activar (ON) o desactivar (OFF) la comunicación

▪ **WDG CONFIG.**

- Ajuste el valor con  y 
- Es posible ajustar como: Hardware Reset, Com. Reset, Stop Dosage y WDG Alarm (valor por defecto).



▪ **RS485 WATCHDOG**

- Ajuste el valor con  y 
- Es posible ajustar el tiempo en segundos. Si está ajustado en OFF (valor por defecto) la comunicación watchdog está desactivada.

▪ **DIRECCION**

- Ajuste el valor con  y 
- Es posible ajustar la dirección del aparato desde 1 (valor por defecto) hasta 247.



▪ **PARITY**

- Adjust value with  and 
- El valor del bit de paridad, es posible ajustar como : Igual (valor por defecto), Impar o No.



▪ **BAUDRATE**

- Ajuste el valor con  y 
- El valor de la velocidad de transmisión, es posible ajustar como : 2400, 4800, 9600 (valor por defecto), 19200.



○ **SETPOINT 7.4PH**

- Ajustar el valor con  y los pulsadores de subir o bajar 
- Es posible ajustar desde 0 a 14 el valor de pH y 0 to 1000 mV para Redox



○ **TIPO SETPOINT**

- Ajustar el valor con  y los pulsadores de subir o bajar 
- Es posible ajustar Acido (pH -) o Alcalino (pH +) y Alto (dosificación oxidante) o Bajo (dosificación reductor) para Redox.



○ **TIEMPO OFA ____ OFF**

- Ajustar el valor con  y los pulsadores de subir o bajar 
- Es posible ajustar el tiempo de OFA en minutos

○ CALIBRACION ____ 7/4PH

- Ajustar el valor con  y los pulsadores de subir o bajar 
- Es posible seleccionar 2 puntos pH y pH 4 , 1 punto solo pH7 o funcion desconectada; para Redox solo es posible desconectar la funcion.

○ TEMPERATURA ____ 25°C

- Ajustar el valor con  y los pulsadores de subir o bajar 
- Esta función solo esta disponible para la medida de pH.

• Para salir y escapar del menú de programación pulsar la tecla ESC.

○ SALIN ____ SALVAR

- Ajustar el valor con  y los pulsadores de subir o bajar 

○ CEBADO

• Para cebar (cargar) la bomba dosificadora presionar el pulsador  durante 3 segundos.





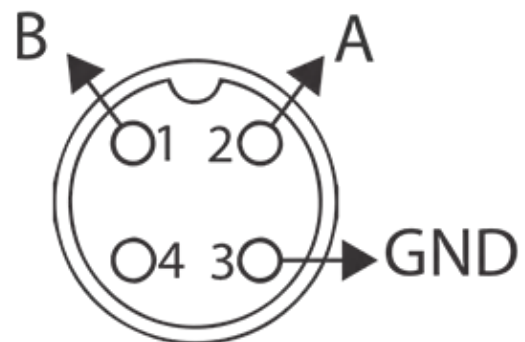
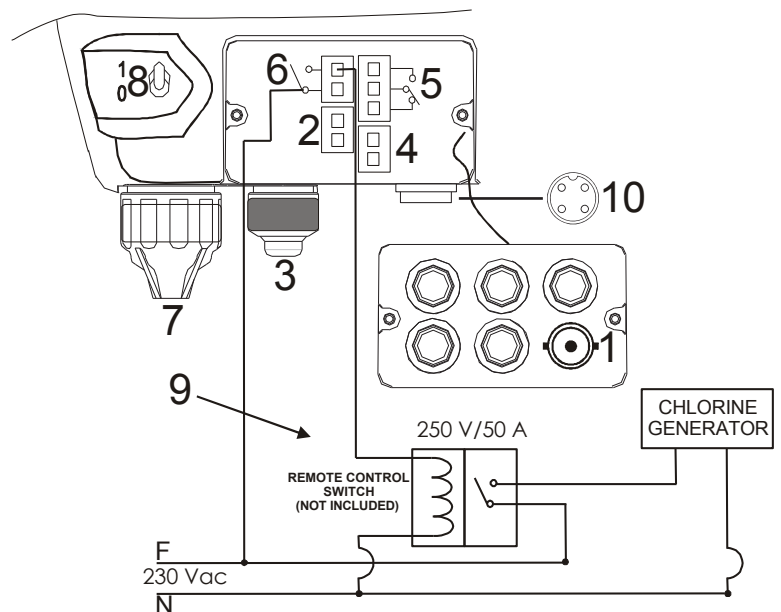



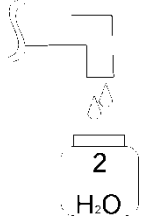

Conexiones:

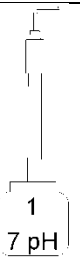
- 1) **Input Probe**, connexion electrodo.
- 2) **Input Temp**, sensor temperatura (PT100) no incluida,
- 3) **Input Level**, control de nivel del tanque de producto químico, no incluido
- 4) **Input Flow**, entrada de control de recirculación (entrada de 230 Vac)
- 5) **Alarm Relay** rele de alarma libre de potencial 250Vac 10 A.
- 6) **S.V. Relay** Rele para control de electro válvula libre de potencial 250Vac 10A
- 7) Alimentación 230 Vac
- 8) Interruptor de paro – marcha.
- 9) Conexión a un generador de cloro (ejemplo).
- 10) Conexión de puerto para la comunicación ModBus



Conexión ModBus	
Pin N°	Descripción
1	T+R+ (B)
2	T-R- (A)
3	GND
4	No utilizado







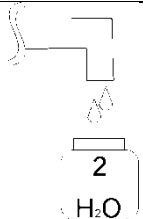

Calibración electrodo de pH

 <p>①</p>	 <p>②</p>	 <p>③</p> <p>Lavar</p>
 <p>④</p> <p>Poner en la solución pH 7</p>	<p>CALIBRACIÓN</p>  <p>Pulsar CAL durante 3 segundos</p> <p>5</p>	<p>PRESS_CAL</p>  <p>Duración de la calibración 1 min.</p> <p>ESPERE ___ 60S ___</p> <p>6</p>
<p>PH7_CALIDAD_100%</p> <p>Calidad electrodo</p> <p>7</p>	 <p>⑧</p> <p>Lavar</p>	 <p>⑨</p> <p>Poner en la solución pH 4</p>
<p>PH 4 ___ PRESS_CAL</p>  <p>Duración de la calibración 1 min.</p> <p>ESPERE ___ 60S ___</p> <p>10</p>	<p>PH4_CALIDAD_100%</p> <p>Calidad electrodo</p> <p>11</p>	 <p>⑫</p> <p>Lavar</p>
 <p>⑬</p>	 <p>Presionar ENTER para salvar y salir</p> <p>14</p>	<p>15</p> <p>Estado Normal</p>

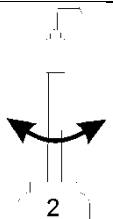
Nota:

Si en la configuración en el menú de calibración eligió 1 punto, solo precisará solución patrón pH7.

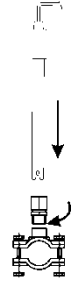
Calibración electrodo de Redox

<p>①</p> 	<p>②</p> 	<p>③</p>  <p>Lavar</p>
<p>④</p>  <p>Keep probe into Buffer solution</p>	<p>5</p> <p>CALIBRACIÓN</p>  <p>Pulsar CAL durante 3 segundos</p>	<p>6</p> <p>465mV__PRESS_CAL</p>  <p>Duración de la calibración 1 min.</p> <p>ESPERAR_____60S__</p>
<p>7</p> <p>465mV_CALIDAD_100%</p> <p>Calidad electrodo</p>	<p>⑧</p>  <p>2 H₂O</p>	<p>⑨</p> 
<p>10</p>  <p>Presionar CAL durante 3 segundos</p>	<p>11</p> <p>Estado Normal.</p>	

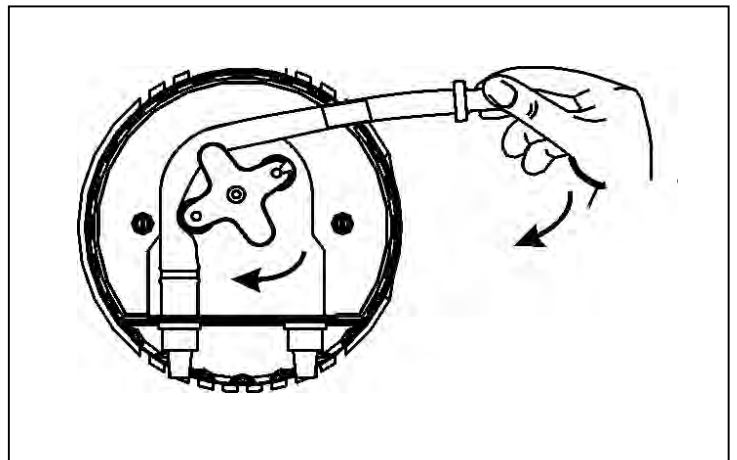
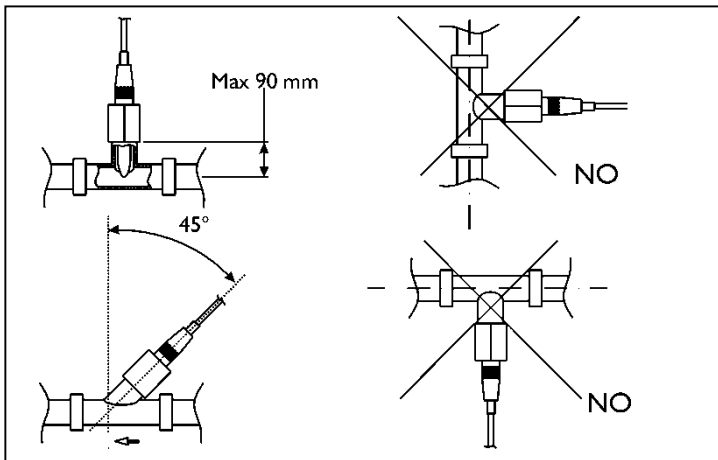
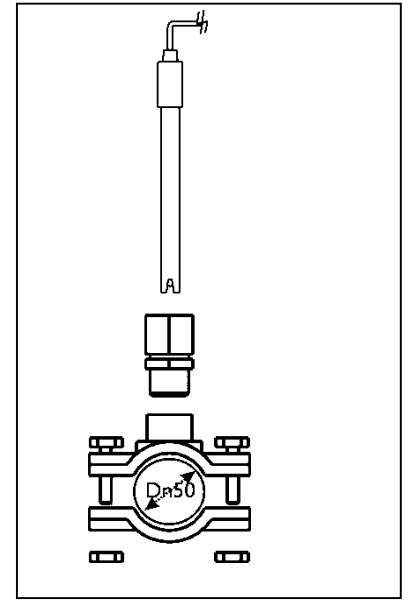
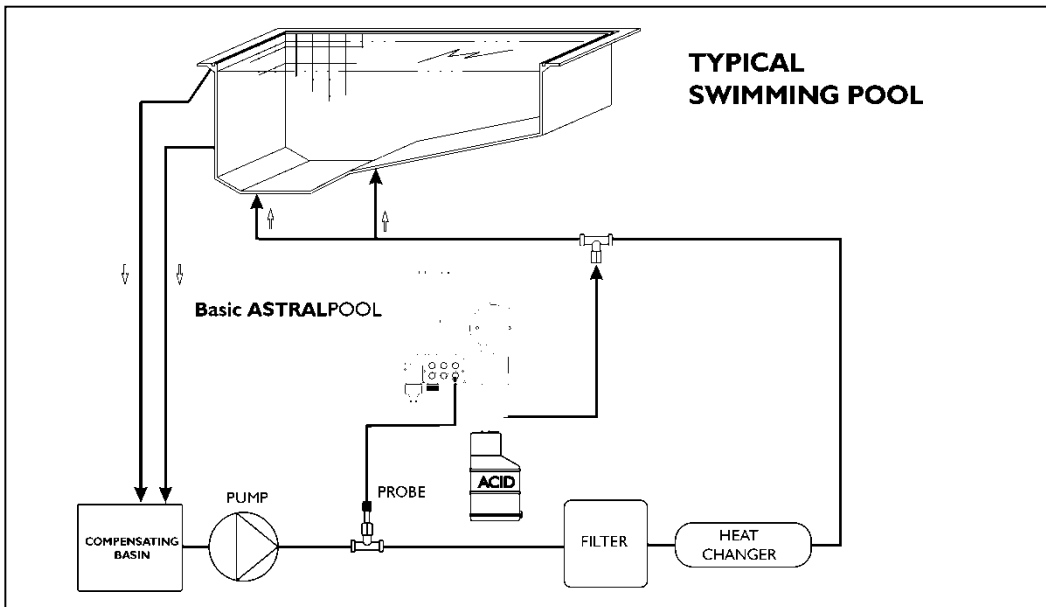

Alarma	Display	Rele	Acciones a hacer
Level	LEVEL ___ 7,2_PH	Rele de alarma cerrado	- Pulsar Enter para abrir el rele de alarma. - Rellenar el deposito de producto químico
OFA First Alarm (time >70%)	OFA_ALARM_ 7,2_PH	Rele de alarma abierto	- Pulsar Enter para aceptar.
OFA Second Alarm (time =100%)	OFA_STOP_ 7,2_PH	Rele de alarma cerrado	- Pulsar Enter para acepta
Flow Rate	FLOW_ 7,2_PH	Rele de alarma abierto	- Restaurar el caudal o recirculación.
System Error	PARAMETER_ERROR	Rele de alarma abierto.	- Presione Enter para sustituir el valor defectuoso - Equipo averiado. - Posible obstrucción de la inyección
Comunicación alarma Watchdog	WDG_ALARM	Rele de alarma cerrado	- Controle la red de comunicación
Calibration Funciont	ERROR_7_PH ERROR_4_PH	Rele de alarma abierto.	- Sustituir el electrodo o solución patrón y repetir la calibración.

Parámetros de fabrica:

- Idioma = **UK**
- Set Point= **7,4 pH**
- Tipo de dosificación = **Acid**
- Tiempo OFA = **OFF**
- Calibración = **7/4 points)**
- Entrada de caudal **OFF**
- Tipo de dosis= **PROP**

Restaurar valores de fabrica:

- Desconectar la unidad electricamente
- Manteniendo pulsado subir y bajar dar corriente a la unidad.
- En el display parpadea **INIT.DEFAULT_NO**
- Presionar el pulsador subir **INIT.DEFAULT_YES**
- Presionar el pulsador Enter para restaurar los valores de fabrica..

CONTROL BASIC PLUS **ASTRALPOOL**

Contenu de l'emballage

- A) "Basic **ASTRALPOOL**" système de contrôle de pH / REDOX
- B) Tuyau PVC Crystal 4x6 (2 mètres)
- C) Tuyau Polyéthylène (3 mètres)
- D) Vis avec chevilles ($\phi = 6$ mm)
- E) Filtre d'aspiration (PVC)
- F) Clapet de non-retour en Viton FPM (3/8" GAZ)
- G) Connecteur Modbus

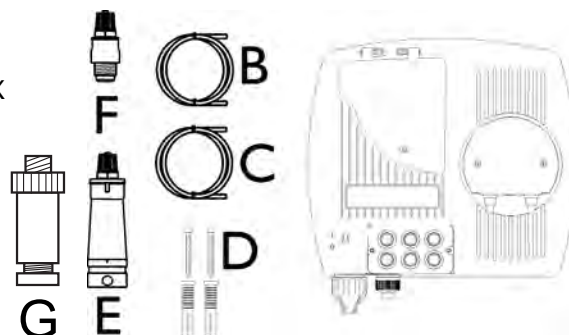

SPÉCIFICATIONS TECHNIQUES

Dimensions (H – L – P)	234x162x108 mm
Poids	1 kg
Alimentation	230 VC.A.
Consommation	12 W ou 18 W
Débit de la pompe	1,5 l/h ; 5 l/h
Contre-pression maximale	1,5 bar
État de la pompe	Pause - Activation
Échelle de mesure	0 ÷ 14,0 pH ou Redox 0 ÷ +1000 mV
Précision de la mesure	± 0,1 pH; ±10 mV
Mesure d'exactitude	± 0,02 pH; ±2 mV
Étalonnage de l'électrode	Automatique

Fixation murale

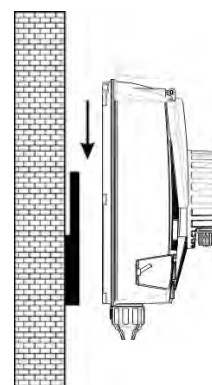

ATTENZIONE / WARNING / ATTENTION / ACHTUNG

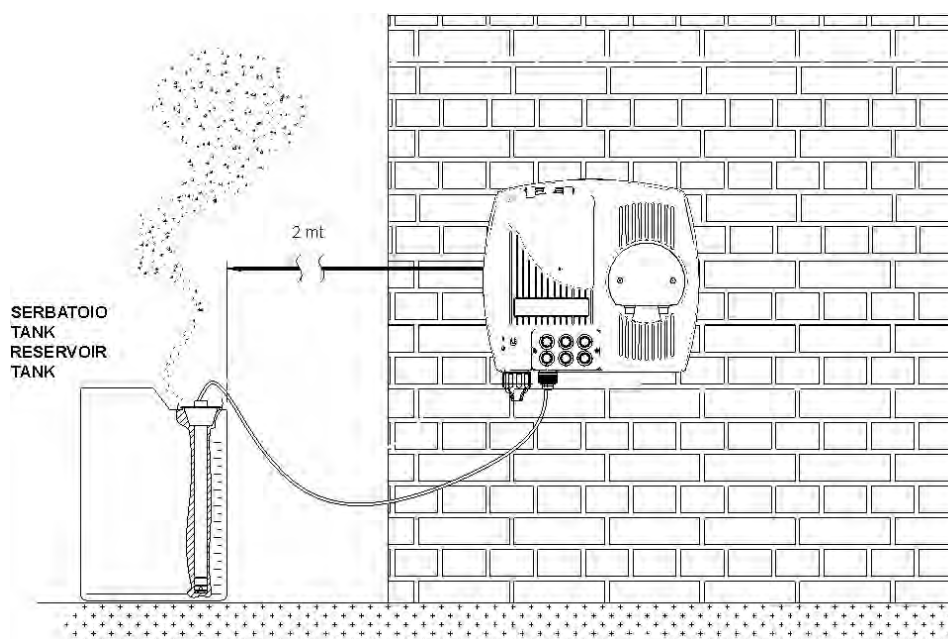

Réglages

Fonction :

- **Étalonnage**

- Appuyer sur la touche  pendant 3 secondes
 - Séquence Standard étalonnage pour la solution tampon 7 et 4 pH.

- **Set Point ou point de consigne**

- appuyer sur la touche 
 - Maintenir la touche Set Key appuyée et modifier la valeur par les flèches

- SP_7.4PH

- Appuyer sur les touches  Setup (en même temps) pendant 5 secondes pour activer le menu configuration:

- **PARAMETRES**

- Appuyer sur  pour programmer les paramètres ci-après

- **CONFIG. POMPE**

- (Sélectionner  pH ou Rédox)

- **LANGUE**

- (On peut régler 5 différentes langues EN, IT, SP, DE, FR)

- **TYPE DE DOSAGE**

- Sélectionner avec la touche  et programmer avec flèche
- Il est possible de régler la valeur entre PROP ou ON / OFF



- **DEBIT**



- (Appuyer sur les flèches Haut et Bas)
- On peut activer (ON) ou désactiver (OFF) l'entrée Flux (haute tension) connectée en parallèle à la pompe de circulation



- **PARAMETRES RS485**



- Appuyez sur  pour régler le point suivant



- **RS-485**



- Réglez la valeur avec  et 
- Il est possible d'activer (ON) ou désactiver (OFF) la communication

- **WDG CONFIG.**
 - Réglez la valeur avec  et 
 - Il est possible de régler comme: Hardware Reset, Com. Reset, Stop Dosage et WDG Alarm (valeur par défaut).



- **RS485 WATCHDOG**
 - Réglez la valeur avec  et 
 - Il est possible de régler le temps en secondes. S'il est réglé en OFF (valeur par défaut) la communication watchdog est désactivée.



- **ADRESSE**
 - Réglez la valeur avec  et 
 - Il est possible de régler l'adresse de l'appareil de 1 (valeur par défaut) à 247

- **PARITY**
 - Réglez la valeur avec  et 
 - La valeur du bit de parité, il est possible de régler comme: Paire (valeur par défaut), Impaire ou Aucune
 -



- **BAUDRATE**
 - Réglez la valeur avec  et 
 - La valeur de la vitesse de transmission, il est possible de régler comme : 2400, 4800, 9600 (valeur par défaut), 19200.

- **CONSIGNE___7.4PH**
 - Sélectionner avec la touche  et programmer avec flèche
 - On peut modifier la valeur de 0 à 14 pH ou de 0 à +1000 mV pour la mesure du potentiel Rédox.



- **PRODUIT DOSE__ACIDE**
 - Sélectionner avec la touche  et programmer avec flèche 
 - On peut le modifier pour dosages Acides ou Alcalins ou High (haut) ou Low (bas) pour le potentiel Rédox.

- **TEMPS OFA___OFF**
 - Sélectionner avec la touche  et programmer avec flèche 
 - On peut modifier le temps OFA (minutes), temps de surdosage

○ CALIBRAGE_7/4PH

- (Sélectionner avec la touche  et programmer avec flèche 
- On peut modifier la séquence de calibrage pour 2 points (7 et 4 pH), pour 1 point uniquement 7pH ou désactiver la fonction ; pour la mesure du potentiel Rédox, le choix est entre 465 mV et fonction désactivée.

○ CORRECTION TEMP._25°C

- Sélectionner avec la touche  et programmer avec flèche 
- On peut programmer la valeur de température manuelle (uniquement pour la mesure du pH).

- Enregistrer puis quitter le menu Programme avec la touche ESC.

○ EXIT_SAUVEGARDER

- Sélectionner avec la touche  et programmer avec flèche 

- Pour la Fonction amorçage en manuel, maintenir la touche flèche  appuyée pendant 3 secondes

○ AMORCAGE

Connexion des câbles :



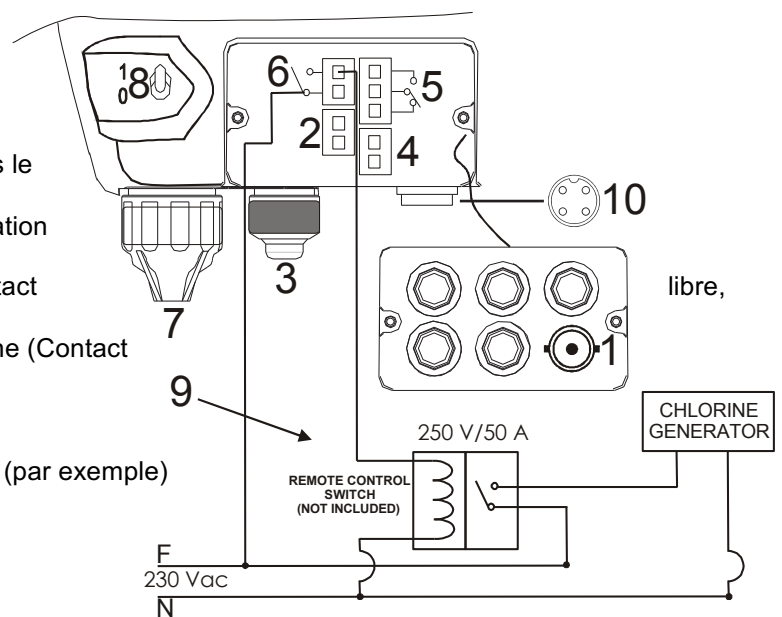



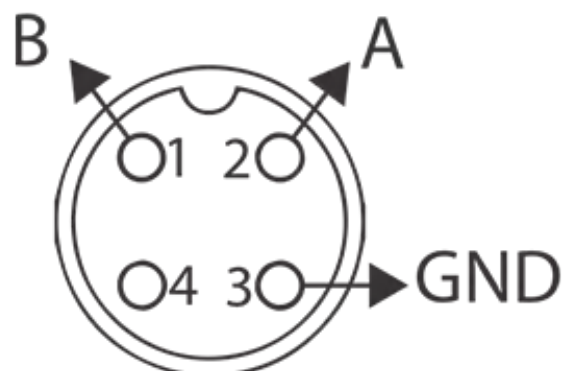



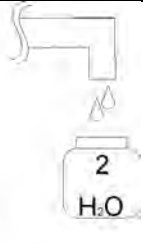

- 1) Entrée sonde pH ou Redox
- 2) Entrée Sonde Température (PT100)
- 3) Entrée sonde de niveau (Produit dans le Bidon)
- 4) Entrée Flow, débit pompe de recirculation (signal électrique 230 Vc.a.)
- 5) Sortie Relais Alarme à distance (Contact Relais 250 Vc.a. 10 A résistif)
- 6) Sortie Relais Alarme pour électrovanne (Contact libre, Relais 250 Vc.a. 10 A résistif)
- 7) Alimentation 230 Vc.a. 50 Hz.
- 8) Interrupteur d'alimentation
- 9) Connexion à un générateur de chlore (par exemple)



Connexion ModBus	
Pin N°	Description
1	T+R+ (B)
2	T-R- (A)
3	GND
4	Non utilisé









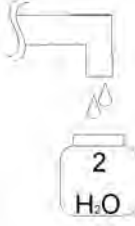

Calibrage Sonde pH

<p>①</p> 	<p>②</p> 	<p>③</p>  <p>Laver la sonde</p>
<p>④</p>  <p>Maintenir la sonde dans la solution tampon</p>	<p style="text-align: center;">CALIBRAGE</p> <p style="text-align: center;"></p> <p style="text-align: center;">Appuyer sur la touche CAL pendant 3 secondes):</p> <p>5</p>	<p style="text-align: center;">7PH_PRESSER_CAL</p> <p style="text-align: center;"></p> <p style="text-align: center;">Le calibrage dure une minute.</p> <p style="text-align: center;">PATIENTER___60S</p> <p>6</p>
<p style="text-align: center;">7PH_QUALITE'_100%</p> <p style="text-align: center;">Qualité de la sonde</p> <p>7</p>	<p>⑧</p>  <p>Laver la sonde</p>	<p>⑨</p>  <p>Maintenir la sonde dans la solution tampon</p>
<p style="text-align: center;">4PH_PRESSER_CAL</p> <p style="text-align: center;"></p> <p style="text-align: center;">Le calibrage dure une minute.</p> <p style="text-align: center;">PATIENTER___60S</p> <p>10</p>	<p style="text-align: center;">4PH_QUALITE'_100%</p> <p style="text-align: center;">Qualité de la sonde</p> <p>11</p>	<p>⑫</p>  <p>Laver la sonde</p>
<p>⑬</p> 	<p style="text-align: center;"></p> <p style="text-align: center;">Appuyer sur la touche Key pour quitter et enregistrer les données</p> <p>14</p>	<p style="text-align: center;">État Normal de mesure et contrôle</p> <p>15</p>

Remarque:

Si l'on programme la fonction Calibrage = 7 pH, le système n'effectue le calibrage que pour le point 7 pH.

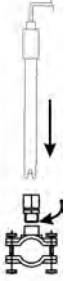
Calibrage sonde Redox

<p>①</p> 	<p>②</p> 	<p>③</p>  <p>Laver la sonde</p>
<p>④</p>  <p>Maintenir la sonde dans la solution tampon</p>	<p>CALIBRAGE</p>  <p>Appuyer sur la touche Cal pendant 3 secondes</p> <p>5</p>	<p>465mV_PRESSER_CAL</p>  <p>Le calibrage dure une minute.</p> <p>PATIENTER__60S</p> <p>6</p>
<p>7</p> <p>465mV_QUALITE'_100%</p> <p>Qualité de la sonde</p>	<p>⑧</p>  <p>Laver la sonde</p>	<p>⑨</p> 
<p>⑩</p>  <p>Appuyer sur la touche Cal pendant 3 secondes</p>	<p>⑪</p> <p>État normal de mesure et de contrôle</p>	

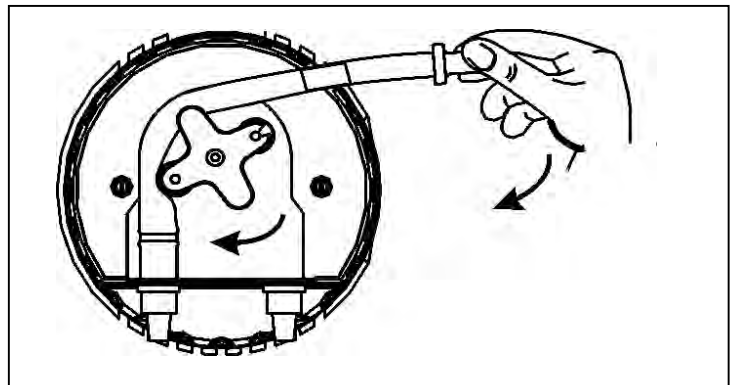
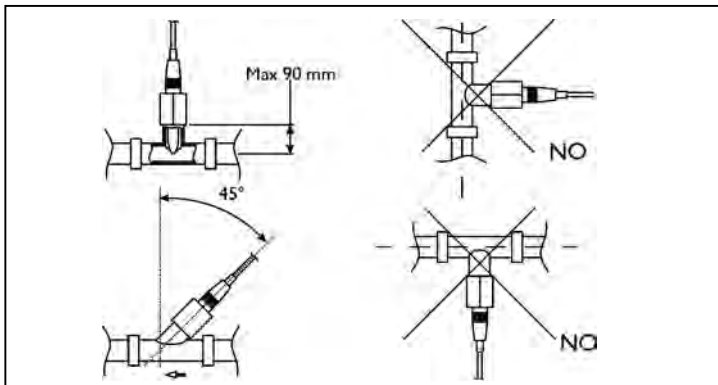
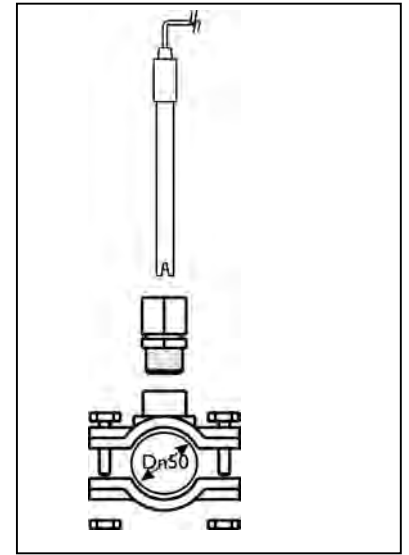
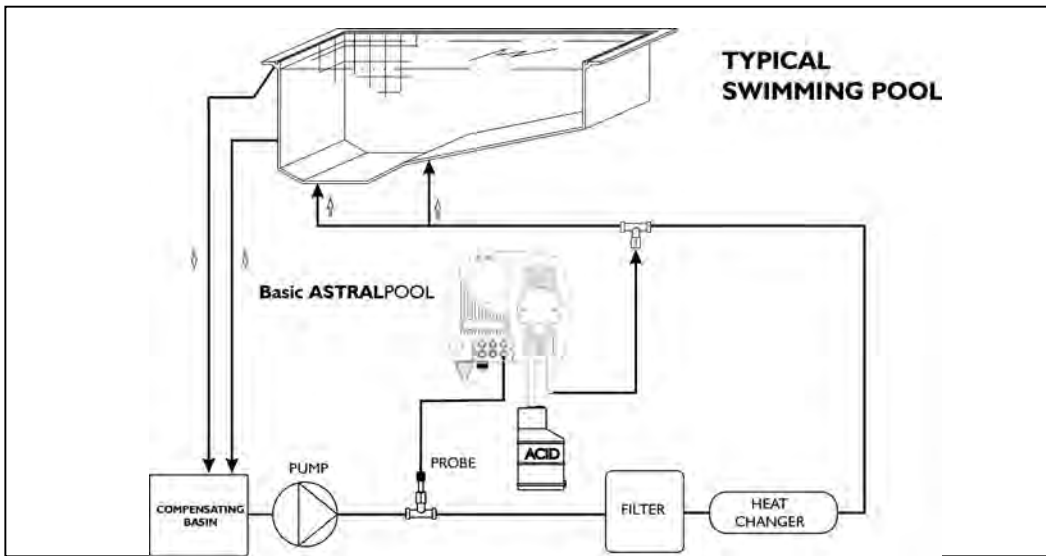

Alarme	Écran	Relais	Actions à exécuter
Niveau	NIVEAU__7,2_PH	Alarme relais fermé	- Appuyer sur la touche Enter pour désactiver l'alarme à distance - Rétablir le niveau de produit dans le bidon
OFA Première Alarme (Temps >70%)	ALARME_OFA_7,2_PH	Alarme relais ouvert	- Appuyer sur la touche Enter pour désactiver l'alarme
OFA Deuxième Alarme (Temps=100%)	STOP_OFA__7,2_PH	Alarme relais fermé	- Appuyer sur la touche Enter pour désactiver l'alarme
Débit eau (pompe de recirculation éteinte)	DEBIT_____7,2_PH	Alarme relais ouvert	- Réactiver la pompe de circulation eau.
Erreur de système	PARAMETER_ERROR	Alarme relais ouvert	- Appuyer sur Enter pour restaurer les paramètres par défaut - Système endommagé
Communication alarme Watchdog	WDG_ALARM	Alarme relais fermé	- Contrôlez le réseau de communication
Fonction d'étalonnage	ERREUR_7_PH ERREUR_4_PH ERREUR_465_MV	Alarme relais ouvert	- Remplacer la Sonde ou la Solution tampon et répéter le calibrage.

Paramètres d'usine :

- Langue = **UK (Inglese)**
- Set Point valere = **7,4 pH; 750mV (Rx)**
- Méthode de dosage = **Acide; Basse (Rx)**
- Temps OFA (alarme de surcharge) = **OFF**
- Calibrage = **7/4 (2 points) ; 465mV (Rx)**
- Entrée Flux = **OFF**
- Type de dosage= **PROP**

Pour restaurer les paramètres par défaut (Défaut), agir de la façon suivante :

- Arrêter le système Basic.
- Activer le système Basic en maintenant les touches flèche HAUT (UP) et flèche BAS (DOWN) appuyées.
- Le Système affiche **R.A.Z.DEFAUT_NON**
- Appuyer sur flèche HAUT (UP) **R.A.Z.DEFAUT_OUI**
- Appuyer sur la touche Enter pour restaurer les paramètres.

CONTROL BASIC PLUS **ASTRALPOOL**

Contenuto nella Scatola

- A) "Basic **ASTRALPOOL**" pH / REDOX Sistema di controllo
- B) Tubo PVC Crystal 4x6 (2 metri)
- C) Tubo Polyethylene (3 metri)
- D) Viti con tasselli ($\phi = 6$ mm)
- E) Filtro di fondo (PVC)
- F) Valvola di non ritorno in FPM (3/8" GAS)
- G) Connettore ModBus

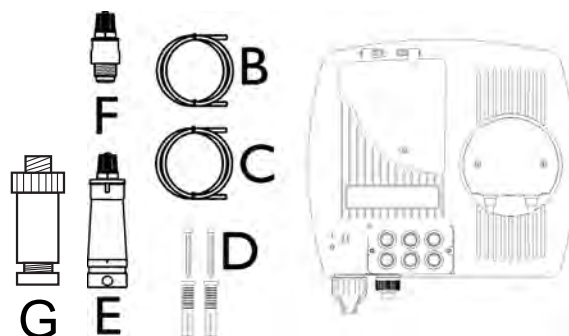

TECHNICAL SPECIFICATIONS

Dimensioni (A – L – P)	234x162x108 mm
Peso	1 kg
Alimentazione	230 VAC
Consumo	12 W or 18 W
Portata Pompa	1,5 l/h; 5 l/h
Contro pressione Massima	1,5 bar
Pump state	Pause - Supply
Scala Misura	0 ÷ 14.0 pH; Redox 0 ÷ +1000 mV
Precisione Misura	± 0,1 pH; ±10 mV
Accuratezza Misura	± 0,02 pH; ±2 mV
Calibrazione Elettrodo	Automatica

Montaggio Parete

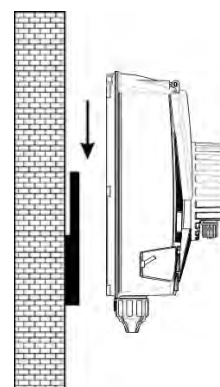

ATTENZIONE / WARNING / ATTENTION / ACHTUNG

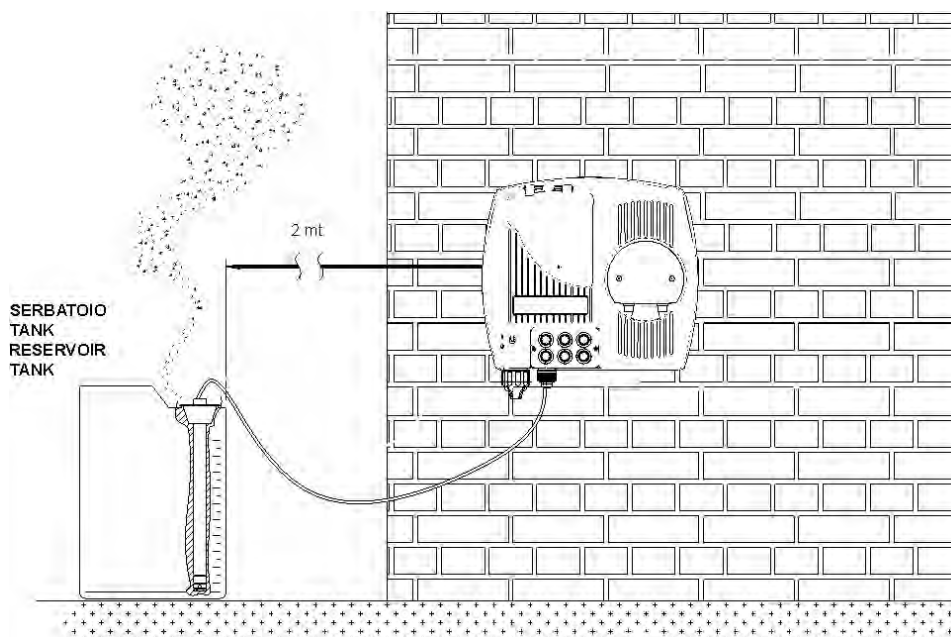



Impostazioni



Funzione:

- **Calibrazione**

- (Premere tasto  per 3 Secondi):
 - Sequenza Standard calibrazione per soluzione tampone 7 and 4 pH.

- **Set Point**

- Premere tasto: 
- Tenere premuto Set Key e modificare valore con tasto 
 - SP_7.4PH

- Premere tasti   Setup (insieme) per 5 Secondi e si eseguirà il menu configurazione:

- **MENU CONFIGURAZIONE**

- (Premere  impostare le seguenti voci)

- **CONFIGURAZIONE POMPA**

- (Selezionare  pH o Redox)

- **LINGUA**

- (Con il pulsante  si può impostare 5 lingue EN, IT, SP, DE, FR)

- **TIPO DI DOSAGGIO**

- Selezionare con il tasto 
- Si può selezionare il valore tra PROP o ON/OFF

- **FLUSSO**

- Selezionare con il tasto 
- Si può abilitare(ON) or disabilitare (OFF) l'ingresso Flusso (alta tensione) collegato in parallelo alla pompa di ricircolo



- **CONFIG. RS485**

Premere  per impostare le seguenti voci

- **RS-485**



- Regolare il valore con il tasto  e 
- È possibile abilitare (ON) o disabilitare (OFF) la comunicazione.

- **MOD CONFIG.**

- Regolare il valore con il tasto  e 

- È possibile impostare come: Hardware Reset, Com. Reset, Stop Dosage and WDG Alarm (valore di default).



▪ **RS485 WATCHDOG**

- Regolare il valore con il tasto  e 
- È possibile regolare il tempo in secondi. Se impostato ad OFF (valore di default) il watchdog è disabilitato.



▪ **INDIRIZZO**

- Regolare il valore con il tasto  e 
- È possibile impostare l'indirizzo del dispositivo da 1 (valore di default) a 247.



▪ **PARITÀ**

- Regolare il valore con il tasto  e 
- Il valore del bit di parity è possibile impostarlo come: Even (valore di default), Odd o No.



▪ **BAUDRATE**

- Regolare il valore con il tasto  e 
- Il valore di velocità trasmissione può essere impostato come: 2400, 4800, 9600 (valore di default), 19200.



○ **SETPOINT__7.4PH**

- Selezionare con il tasto  e impostare con 
- Si può modificare il valore da 0 a 14 pH oppure da 0 a +1000 mV per misura Redox.



○ **TIPO SETPOINT__ACIDO**





- Selezionare con il tasto  e impostare con 
- Si può modificare per dosaggi Acidi o Alcalini oppure High or Low per Redox.

○ **TEMPO OFR__OFF**

- Selezionare con il tasto  e impostare con 
- Si può modificare il tempo (minuti) di OFA tempo di sovra dosaggio

○ **CALIBRAZIONE__7/4PH**

- Selezionare con il tasto  e impostare con 
- Si può modificare la sequenza di calibrazione per 2 punti (7 and 4 pH), oppure 1 punto solo 7pH o funzione disabilitata; per il Redox abbiamo 465 mV o funzione disabilitata.

- TEMPERATURA MAN. __25° C
 - Selezionare con il tasto  e impostare con 
 - Si impostare il valore di temperatura manuale (Solo per la misura del pH)
- Salvare ed uscire dal menù Programma con il tasto ESC.
 - USCITA__SALVA
 - Selezionare con il tasto  e impostare con 
 - ADESCAMENTO
 - Funzione adescamento manuale tenere premuto il tasto  (UP) per 3 secondi

Connessione Cavi:



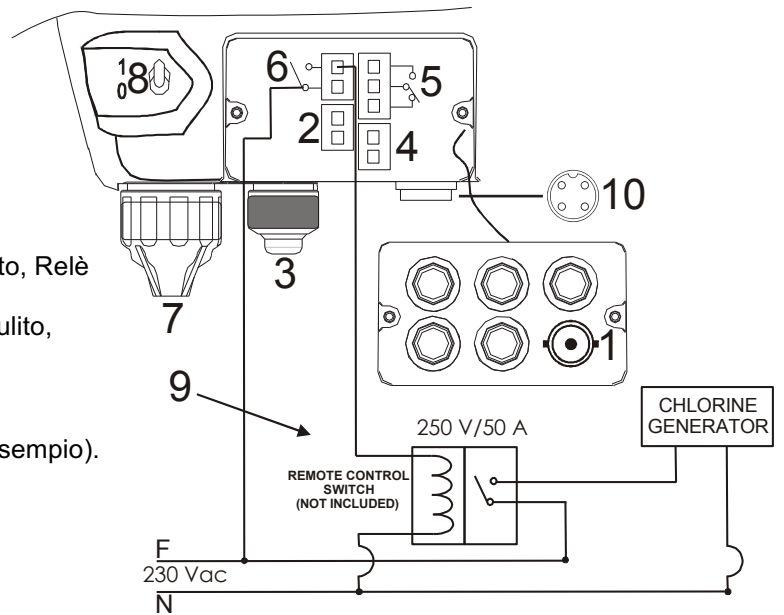



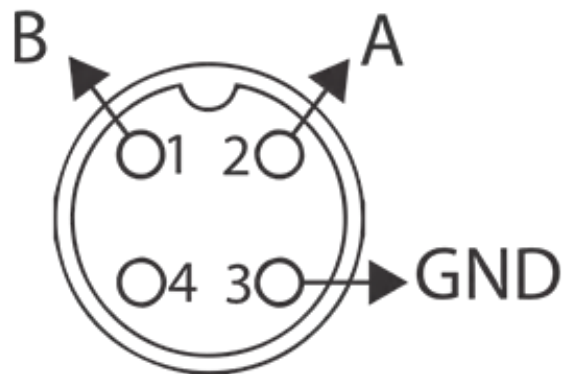



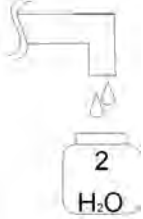

- 1) Ingresso sonda pH or Redox
- 2) Ingresso sonda Temperature (PT100)
- 3) Ingresso sonda Livello (Prodotto nella tanica)
- 4) Ingresso Flow, flusso pompa di ricircolo (segnale elettrico 230 Vac)
- 5) Uscita Relè Allarme remoto (Contatto pulito, Relè 250 Vac 10 A Resistivo)
- 6) Uscita Relè per Elettrovalvola (Contatto pulito, Relè 250 Vac 10 A Resistivo)
- 7) Alimentazione 230 Vac 50Hz.
- 8) Interruttore di alimentazione.
- 9) Connessione ad un generatore di cloro (esempio).
- 10) Porta connessione MobBus



Connessione ModBus	
N° PIN	Descrizione
1	T+R+ (B)
2	T-R- (A)
3	GND
4	Not used









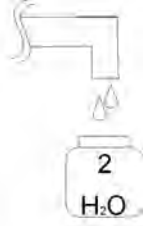

Calibrazione Sonda pH

<p>①</p> 	<p>②</p> 	<p>③</p>  <p>Lavare la sonda</p>
<p>④</p>  <p>Mantenere la sonda nella soluzione tampone</p>	<p style="text-align: center;">CALIBRAZIONE</p>  <p>Premere tasto CAL per 3 Secondi</p> <p>5</p>	<p style="text-align: center;">7PH__PREMERE_CAL</p>  <p>La calibrazione dura un minuto</p> <p style="text-align: center;">ATTENDERE__60S</p> <p>6</p>
<p style="text-align: center;">7PH_QUALITA'_100%</p> <p>Qualità sonda</p> <p>7</p>	<p>⑧</p>  <p>Lavare la sonda</p>	<p>⑨</p>  <p>Mantenere la sonda nella soluzione tampone</p>
<p style="text-align: center;">4PH__PREMERE_CAL</p>  <p>La calibrazione dura un minuto</p> <p style="text-align: center;">ATTENDERE__60S</p> <p>10</p>	<p style="text-align: center;">4PH_QUALITA'_100%</p> <p>Qualità sonda</p> <p>11</p>	<p>⑫</p>  <p>Lavare la sonda</p>
<p>⑬</p> 	 <p>Premere il tasto Key per uscire e salvare i dati</p> <p>14</p>	<p>15</p> <p>Stato Normale di misura e controllo</p>

Nota:

Se impostiamo la funzione Calibrazione = 7 pH il sistema eseguirà la calibrazione soltanto per il punto 7 pH.

Calibrazione sonda Redox

<p>①</p> 	<p>②</p> 	<p>③</p>  <p>Lavare la sonda</p>
<p>④</p>  <p>Mantenere la sonda nella soluzione tampone</p>	<p>5</p> <p style="text-align: center;">CALIBRAZIONE</p> <p style="text-align: center;"></p> <p style="text-align: center;">Premere il tasto Cal 3 Secondi</p>	<p>6</p> <p style="text-align: center;">465mV__PREMERE_CAL</p> <p style="text-align: center;"></p> <p style="text-align: center;">La calibrazione dura un minuto</p> <p style="text-align: center;">ATTENDERE__60S</p>
<p>7</p> <p style="text-align: center;">465mV_QUALITA'_100%</p> <p style="text-align: center;">Qualità Sonda</p>	<p>⑧</p>  <p>Lavare la sonda</p>	<p>⑨</p> 
<p>⑩</p> <p style="text-align: center;"></p> <p style="text-align: center;">Premere il tasto Cal 3 Secondi</p>	<p>11</p> <p style="text-align: center;">Normale Stato di misura e controllo</p>	

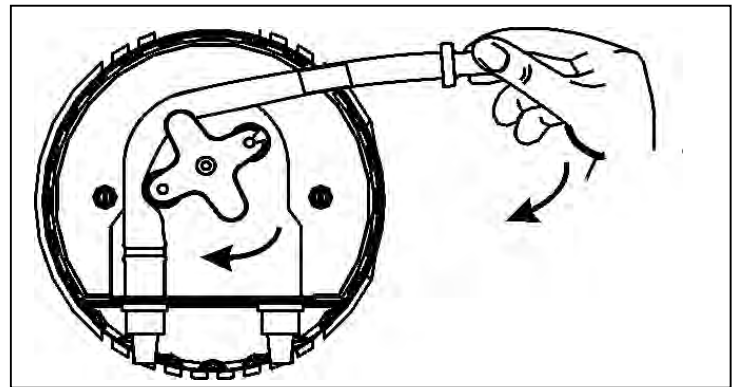
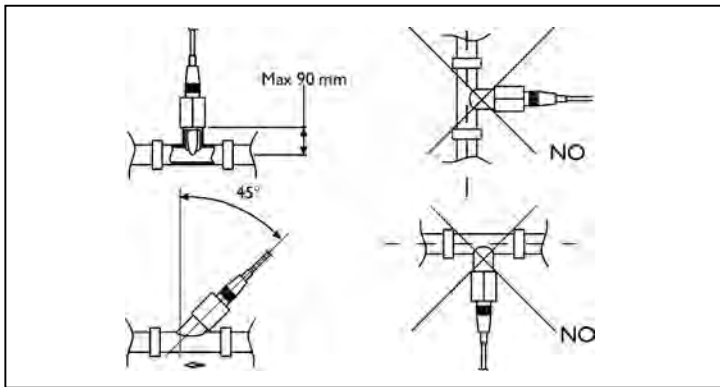
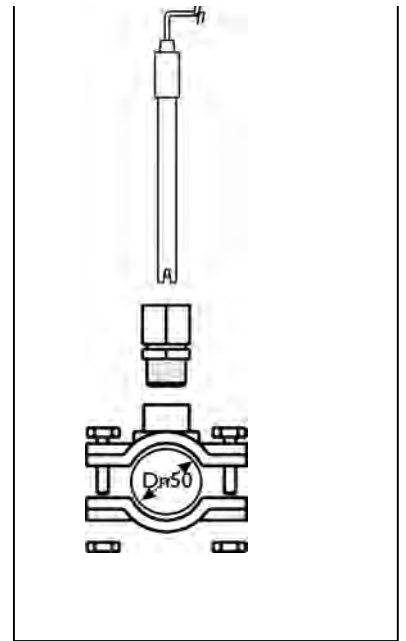
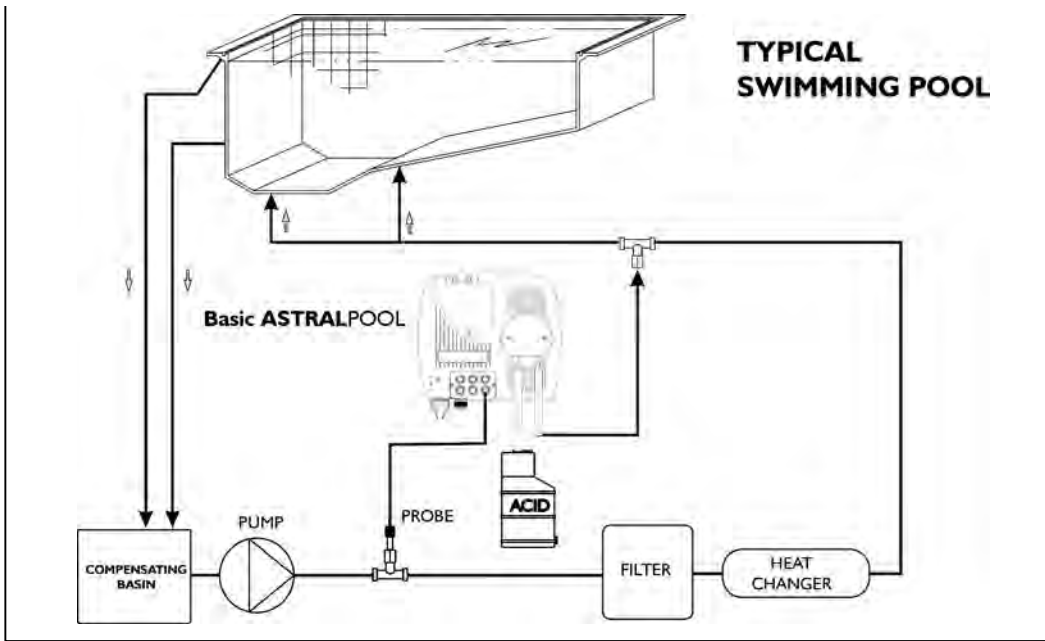

Allarme	Display	Relè	Azioni da fare
Livello	LIVELLO ____ 7,2_PH	Allarme Relè Chiuso	- Premere il tasto Enter per spegnere l'allarme remoto - Ripristinare prodotto nel bidone
OFA Primo Allarme (Tempo >70%)	ALLARME_OFA_7,2_PH	Allarme Relè Aperto	- Premere il tasto Enter per eliminare l'allarme
OFA Secondo Allarme (Tempo=100%)	STOP_OFA__7,2_PH	Allarme Relè Chiuso	- Premere il tasto Enter per eliminare l'allarme
Flusso acqua (Pompa di ricircolo spenta)	FLUSSO ____ 7,2_PH	Allarme Relè Aperto	- Ripristinare pompa di ricircolo acqua.
Errore di Sistema	PARAMETER_ERROR	Allarme Relè Aperto	- Premere Enter per ripristinare i parametri di fabbrica - Sistema Rotto
Allarme comunicazione Watchdog	WDG_ALARM	Allarme Relè Chiuso	- Verificare la rete di comunicazione
Funzione di Calibrazione	ERRORE_7_PH ERRORE_4_PH ERRORE_465_MV	Allarme Relè Aperto	- Sostituire Sonda o Soluzione tampone e ripetere la calibrazione.

Parametri di Fabbrica:

- Lingua = **UK (Inglese)**
- Set Point valore = **7,4 pH; 750mV (Rx)**
- Metodo di Dosaggio = **Acido; Basso (Rx)**
- Tempo OFA = **OFF**
- Calibrazione = **7/4 (2 punti); 465mV (Rx)**
- Ingresso Flusso = **OFF**
- Tipo dosaggio= **PROP**

Per ripristinare I parametri di fabbrica (Default) eseguire i seguenti passi:

- Spegnere il sistema Basic
- Mantenere premuto il tasto UP (su) e DOWN (giù) accendere il sistema Basic .
- Il Sistema visualizzerà **INIT.DEFAULT_NO**
- Premere UP (su) **INIT.DEFAULT_YES**
- Premere il tasto Enter per ripristinare i parametri.

CONTROL BASIC PLUS **ASTRALPOOL**

Conteúdo da Caixa

A) Control Basic ASTRALPOOL" pH / REDOX

Sistema de controle

B) Tubo de PVC Cristal 4x6 (2 metros)

C) Tubo de Polyetileno (3 metros)

D) Parafusos com buchas ($\phi = 6$ mm)

E) Filtro de Fundo (PVC)

F) Válvula de Retenção em FPM (3/8" GAS)

G) Conector ModBus

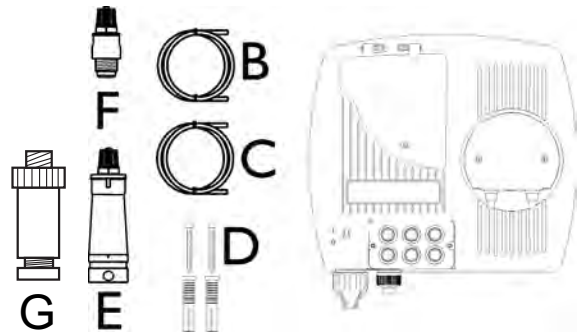

ESPECIFICAÇÕES TÉCNICAS

Dimensões: (A - L - P)	234x162x108 mm
Peso:	1 kg
Alimentação:	230 VAC
Consumo:	12 W ou 18 W
Vazão da Bomba:	1,5 l/h; 5 l/h
Contrapressão Máxima:	1,5 bar
Dosagem da Bomba:	Pause - Trabalho
Escala de Medida:	0 ÷ 14.0 pH; Redox 0 ÷ +1000 mV
Precisão de Medida:	± 0,1 pH; ±10 mV
Precisão do Equipamento:	± 0,02 pH; ±2 mV
Calibragem do Eletrodo:	Automática

Montagem em Parede

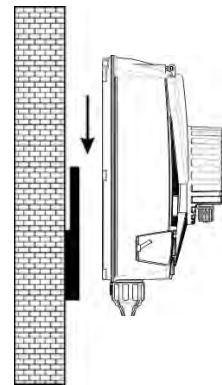

ATENÇÃO / WARNING / ATTENTION / ACHTUNG

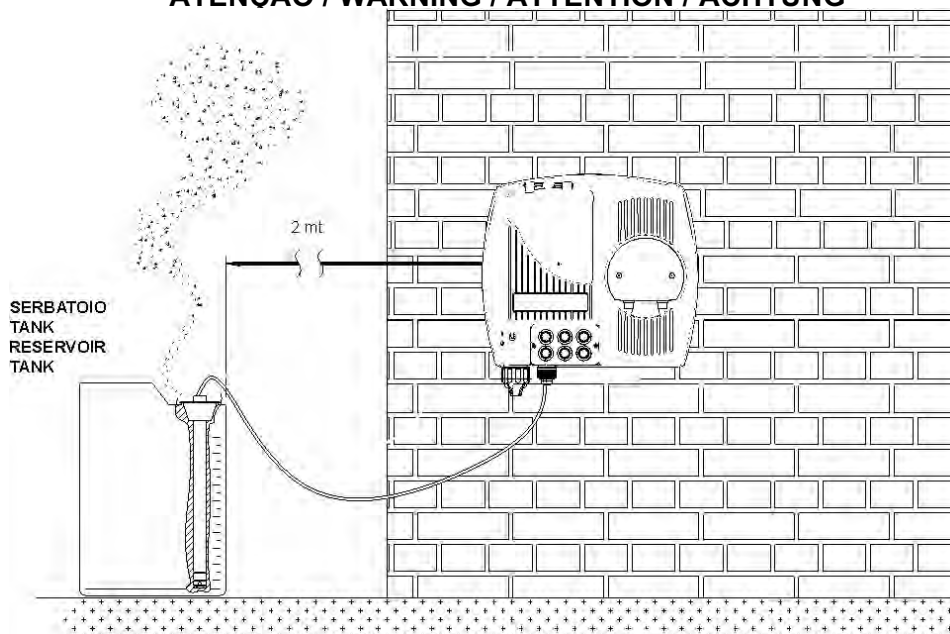

INSTRUÇÕES

Função:

- **Calibração**

- Apertar tecla  por 3 Segundos:
 - Seqüência Padrão de Calibragem para Solução Tampão 7 e 4 pH.

- **Ponto de Calibração**

- Apertar tecla: 
- Manter apertada Set Key e modificar o valor com 
 - **Sp - 7.4ph**

- Apertar as teclas  juntas por 5 Segundos e se obterá o menu de configuração:

- **Program**

- Apertar  e registrar as seguintes vezes

- **Configuration_Pump**

- Selecionar  pH ou Redox

- **Language**

- Com a tecla  pode-se colocar 5 linguas Inglês, Italiano, Espanhol, Alemão, Francês.



- **Flow**

- Selecionar com a tecla 
- Pode-se habilitar (ON) ou desabilitar (OFF) a entrada de Fluxo (alta pressão) conectando em paralelo a bomba de re-circulação



- **RS485_settings**

















- Pressione  para ajustar esse controle

- **RS-485**



- Altere e ajuste o valor selecionando  e 
- E possível ativar (ON) ou desativar (OFF) a comunicação

- **WDG config.**

- Altere e ajuste o valor selecionando  e 
- E possível selecionar as seguintes opções: Hardware Reset, Com. Reset, Stop Dosage e WDG Alarm (valor padrao).



- **RS485 watchdog**
 - Altere e ajuste o valor selecionando  e 
 - É possível ajustar o horário em segundos. Se estiver desligado OFF (valor padrão) a comunicação watchdog esta desativada.
- **Address**
 - Altere e ajuste o valor selecionando  e 
 - É possível ajustar o endereço do dispositivo de 1 (valor padrão) até 247.
- **Parity**
 - Altere e ajuste o valor selecionando  e 
 - É possível escolher as seguintes opções de bit: par (valor padrão), ímpar ou nenhum.
- **Baudrate**
 - Altere e ajuste o valor selecionando  e 
 - É possível selecionar para a velocidade de transmissão os seguintes valores: 2400, 4800, 9600 (valor padrão) e 19200.
- **Tipo de dosagem**
 - Selecionar com a tecla
 - É possível ajustar valor entre PROP ou ON / OFF
- **Set Point 7.4ph**
 - Selecionar com a tecla  e registrar com 
 - Pode-se modificar o valor de 0 a 14 pH ou mesmo de +1000 mV por medida Redox.
- **Tipo Set Point Ácido**
 - Selecionar a tecla  e registrar com 
 - É possível modificar para dosagens Ácidas ou Alcalinas ou também High ou Low por Redox.
- **Tempo OFA Off**
 - Selecionar com a tecla  e registrar com 
 - É possível modificar o tempo (minutos) de OFA tempo de dosagem
- **Calibragem pH 7/4**
 - Selecionar a tecla  e registrar com 
 - É possível modificar a sequência de calibragem por 2 pontos (pH 7 e 4), ou mesmo 1 ponto pH 7 ou função desabilitada; para o Redox temos 465 mV ou função desabilitada.

○ **Temperatura Man 25°C**

- Selecionar com a tecla  e registrar com 
 - É possível registrar o valor de temperatura manual - Somente para a medida do pH.

- Salvar e sair do menu do Programa com a tecla ESC.

○ **Saída Salvar**

- Selecionar com a tecla  e registrar com 

○ **Escorva**

- Função escorva manual manter pressionada a tecla  UP por 3 segundos

Conexao dos Cabos:



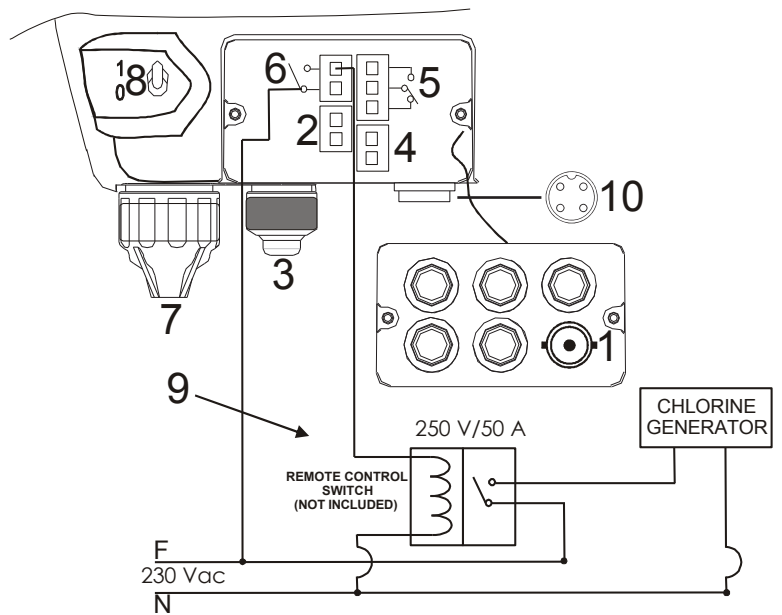



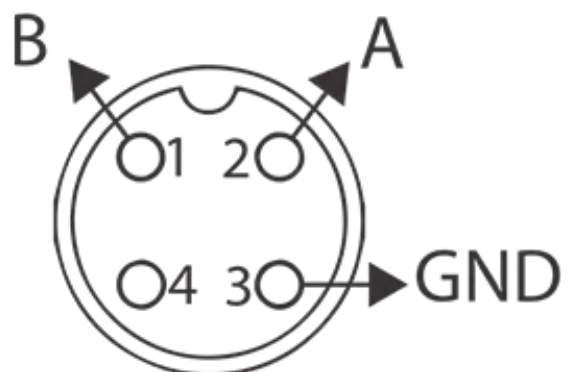



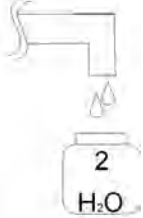

- 1) Entrada da Sonda do pH ou Redox
- 2) Entrada da sonda da Temperatura (PT100)
- 3) Entrada da Sonda de Nível (Dentro da bombona)
- 4) Entrada Flow, vazão da bomba de recirculação (Sinal Elétrico 230 Vac)
- 5) Saída do Relê de Alarme Remoto (Contato limpo Relê 250 Vac 10 A Resistivo)
- 6) Saída do Relê para a Eletroválvula (Contato limpo Relê 250 Vac 10 A Resistivo)
- 7) Alimentação 230 Vac 50Hz.
- 8) Interruptor de Alimentação.
- 9) A conexão com um gerador de cloro (exemplo).
- 10) Conexão de entrada para a comunicação ModBus



Conexao ModBus	
N° do Pin	Descrição
1	T+R+ (B)
2	T-R- (A)
3	GND
4	Nao utilizado









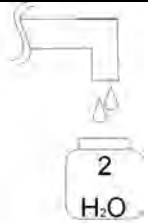

Calibragem da Sonda de pH

 <p>1</p>	 <p>2</p>	 <p>3</p> <p>Lavar a sonda</p>
 <p>4</p> <p>Manter a sonda na Solução Tampão</p>	<p>Calibragem</p>  <p>Acionar a tecla CAL por 3 Segundos</p> <p>5</p>	<p>7 pH Acionar CAL</p>  <p>A calibragem dura um minuto</p> <p>Esperar 60s</p> <p>6</p>
<p>7 pH Qualidade 100%</p> <p>Qualidade da Sonda</p> <p>7</p>	 <p>8</p> <p>Lavar a sonda</p>	 <p>9</p> <p>Manter a Sonda na Solução Tampão</p>
<p>4 pH Acionar CAL</p>  <p>A calibragem dura um minuto</p> <p>Esperar 60s</p> <p>10</p>	<p>4 pH Qualidade 100%</p> <p>Qualidade da Sonda</p> <p>11</p>	 <p>12</p> <p>Lavar a sonda</p>
 <p>13</p>	 <p>Acionar a tecla Key para sair e salvar os dados</p> <p>14</p>	<p>Estado Normal de medida e controle</p> <p>15</p>

Nota:

Se registrarmos a função Calibragem = pH 7 o sistema executa a calibragem somente para o pH 7.

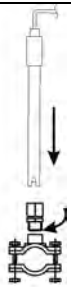
Calibragem da Sonda Redox

<p>1</p> 	<p>2</p> 	<p>3</p>  <p>Lavar a sonda</p>
<p>4</p>  <p>Manter a sonda na solução tampão</p>	<p>5</p> <p style="text-align: center;">Calibragem</p>  <p>Acionar a tecla Cal por 3 Segundos</p>	<p>6</p> <p style="text-align: center;">465mv Acionar_CAL</p>  <p>A calibragem dura um minuto</p> <p style="text-align: center;">Esperar 60s</p>
<p>7</p> <p>465mv Qualidade 100%</p> <p>Qualidade da Sonda</p>	<p>8</p>  <p>Lavar a sonda</p>	<p>9</p> 
<p>10</p>  <p>Acionar a tecla Cal por 3 Segundos</p>	<p>11</p> <p>Estado normal de medida e controle</p>	

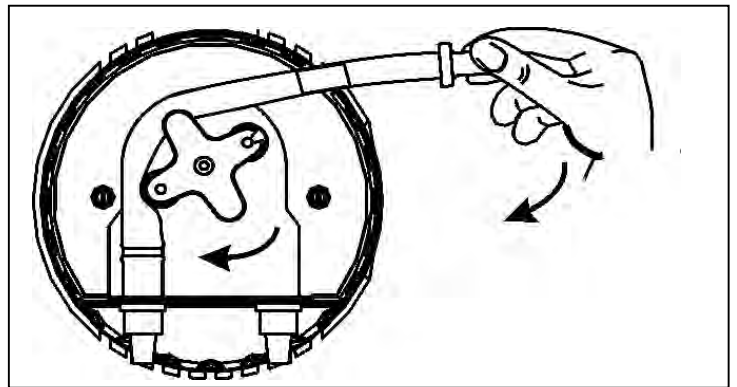
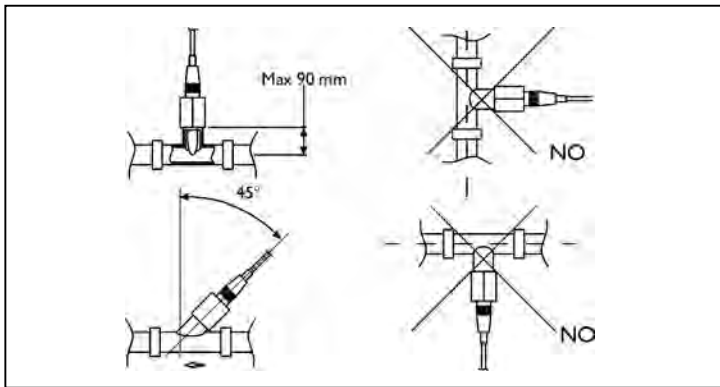
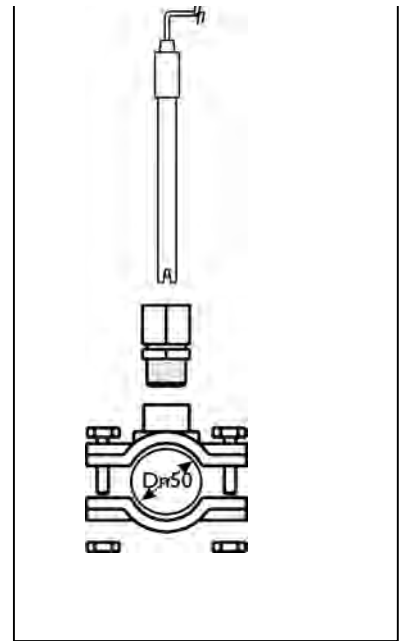
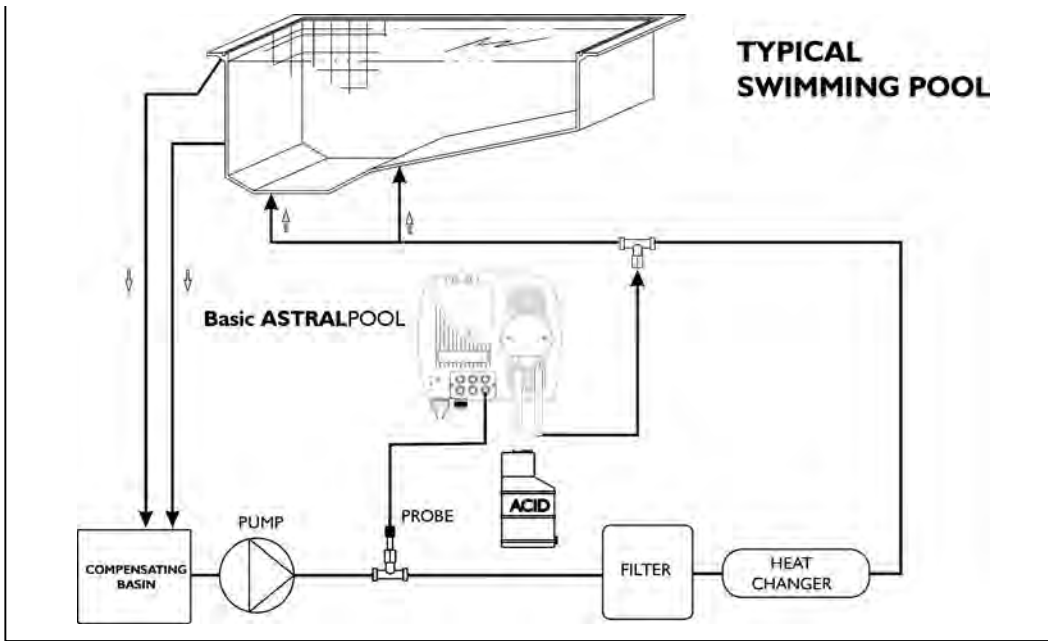

Alarme	Display	Relê	Ações a serem tomadas
Nível	LEVEL___7.2_PH	Relê de Alarme Fechado	- Acionar a tecla Enter para desligar o alarme remoto - Recolocar o produto no recipiente
Primeiro Alarme OFA - Tempo >70%	OFA_ALARM__7.2_PH	Relê de Alarme Aberto	- Acionar a tecla Enter para eliminar o alarme
OFA Segundo Alarme (Tempo=100%)	OFA_STOP___7.2_PH	Relê de Alarme Fechado	- Acionar a tecla Enter para eliminar o alarme
Vazão de Água (Bomba de Recirculação desligada)	FLOW_____7.2_PH	Relê de Alarme Aberto	- Religar a Bomba de Recirculação de Água.
Erro de Sistema	PARAMETER_ERROR	Relê de Alarme Aberto	- Acionar Enter para reestabelecer os parâmetros de fábrica - Sistema defeituoso
Alarme de Comunicação Watchdog	WDG_ALARM	Retransmissão de Alarme Fechado	Verifique a rede de comunicação
Função de Calibragem	ERROR_7_PH ERROR_4_PH ERROR_465_mV	Relê de Alarme Aberto	- Substituir a Sonda ou a Solução Tampão e repetir a calibragem.

Parâmetros de Fábrica:

- Língua = **UK (Inglês)**
- Valor de ajuste = **7,4 pH; 750mV (Rx)**
- Metodo de Dosagem = **Acido; Baixo (Rx)**
- Tempo OFA = **OFF**
- Calibragem = **7/4 (2 pontos); 465mV (Rx)**
- Vazão de entrada = **OFF**

Para restaurar os Parâmetros de Fábrica (Default) seguir os seguintes passos:

- Desligar o Sistema Basic
- Manter pressionada a tecla **UP** (para cima) e **DOWN** (para baixo) ligar o Sistema Basic.
- O Sistema visualizará **Init.default_no**
- Acionar **UP** (Para cima) **Init.default_Yes**
- Acionar a tecla **Enter** para restaurar os parâmetros.