

CAE OMEGA

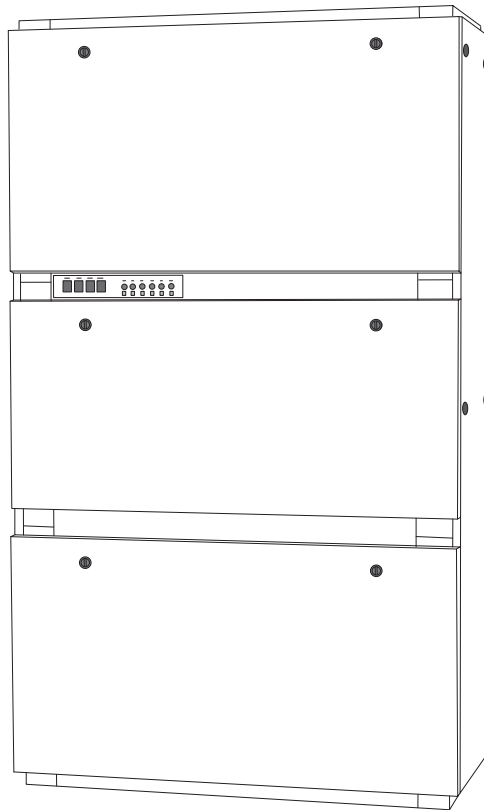

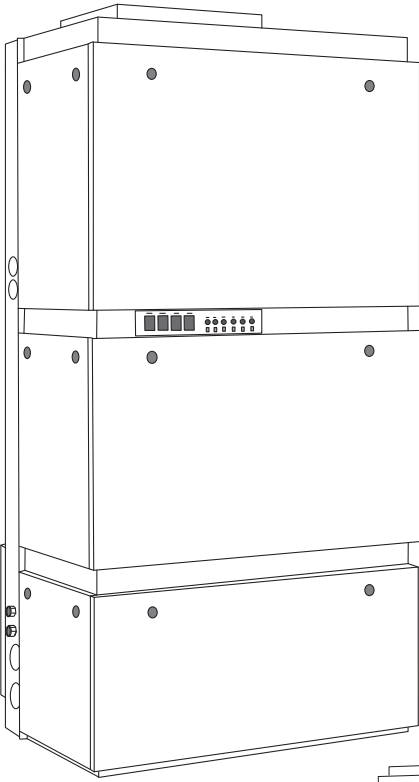

Instructions for installation and use
English

EN

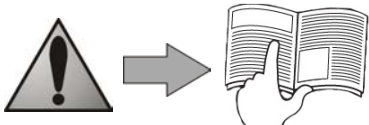
More languages on:
www.zodiac-poolcare.com



- Read this manual carefully before installing, maintaining or repairing this device!
- The symbol  indicates important information that must be taken into account in order to avoid personal injury and/or damage to the appliance.
- The symbol  indicates useful information.



Warning

- Our products may be subject to change without notice as part of our continuous improvement policy.
- Exclusive use: dehumidification of swimming pool premises (not to be used for any other purpose),
- This device must be installed and serviced by certified professionals approved in the electrical, hydraulic and cooling domains,
- It must be installed in premises that are closed and well aired; in an area that is: not exposed to freezing risk, out of reach of water splashes, and where no pool maintenance products are stored, the installation in outside involves the suppression of the guarantee
- The device must be installed by a qualified technician according to the manufacturer's instructions and in compliance with local regulations. The installer is responsible for the correct installation of the device and for ensuring compliance with local regulations. The manufacturer shall not be held liable for any potential issues that may occur as a result of failure to comply with local standards pertaining to installation,
- Incorrect installation may cause serious damage and/or personal injuries (possibly death),
- This appliance must be handled by competent and qualified personnel (physically and mentally) who are familiar with the operating instructions (by reading the user guide). Persons who do not satisfy these requirements must not handle the device so as to avoid exposure to potentially dangerous parts.
- If the device malfunctions: do not attempt to repair the device yourself, call your retailer,
- Before carrying out any operation on the machine, check that the power supply is cut and that the machine is tagged out,
- Prior to any operation, check that the voltage on the identification plate of the appliance corresponds to the main voltage available on site,
- The warranty will automatically become void if any safety device is removed or shunted. This will also apply if any parts are replaced with parts purchased anywhere else than from our stores,
- Keep the appliance out of the reach of children,
- Do not discharge R407C fluid into the atmosphere: R407C is a fluorinated greenhouse effect gas, covered by the Kyoto Protocol, with a Global Warming Potential (GWP) = 1653 - (Directive EC 842/2006).
- According to French decree no. 2007-737 of 7th May 2007, if the appliance has more than 2 kg of refrigerant gas (refer to manufacturer specifications), the cooling circuit must be checked for leakage at least once a year. This operation must be carried out by a certified cooling appliance specialist



Summary

1. Information before installation	2
1.1 General terms of delivery, storage and transport	2
1.2 Content	2
1.3 Operating conditions	3
1.4 Technical specifications	3
2. Installation	3
2.1 Installation requirements	3
2.2 Connection to surrounding air (only on CAE)	4
2.3 Connection through a dividing wall (only on CAE).....	4
2.4 Connection to a duct network	5
2.5 Connection of condensation drainage.....	6
2.6 Electrical connections	7
2.7 Connecting the options.....	10
3. Operation	11
3.1 Different command panel set ups	11
3.2 Starting the appliance	11
3.3 Checks	12
3.4 Adjusting the duct network	12
3.5 Options starting up	12
4. Maintenance	14
4.1 Maintenance instructions	14
4.2 Additional recommendations	14
4.3 Spare parts	15
4.4 Recycling the product	15
5. Troubleshooting	16
5.1 Status and faults in the ECP 600 settings.....	16
5.2 FAQ.....	17
6. Product registration	17
7. Conformity certificate	17

Available in the appendices at the end of the manual:

- wiring diagrams
- Dimensions

1. Information before installation







1.1 General terms of delivery, storage and transport





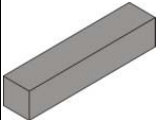

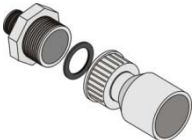
Any equipment, even carriage and packing free, travels at the consignee's risk. The consignee shall make reservations in writing on the carrier's bill of lading if damage is detected, caused during transport (confirmation to be sent to the carrier within 48 hours by registered mail with acknowledgement of receipt).

The device must be transported and stored upright on its pallet in its original packaging.

If the device has been turned on its side, mention your reservations in writing to the carrier.

1.2 Content

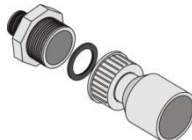
						
CAE (x1)	Hygro control (x1)	anti-vibration studs (x4)	belt (x1)	half union Ø32 connector to glue + PVC fitting 1" + joint (x1)	With condenser option: half union Ø50 connector to glue + joints (x2)	With hot water battery option: Ø20/22 bush to solder + joints (x2)

						
Oméga (x1)	Hygro Control (x1)	anti-vibration studs (x6)	belt (x1 for Oméga 10-14-16-20) (x2 for Oméga 28)	half union Ø32 connector to glue + PVC fitting 1" + joint (x1)	With condenser option: half union Ø50 connector to glue + joints (x2)	With hot water battery option: Ø20/22 bush to solder + joints (x2)

1.3 Operating conditions

- operating range: 10°C to 40°C (temperature in the swimming pool hall)
- optimum operating conditions: between 25 °C and 30 °C
- Hygro Control on request

1.4 Technical specifications

Appliance	Dehumidifying capacity *	Power consumed *	Power restored on the ambient air*	Available pressure**	Air flow-rate
Without option	L/h	W	W	mmCE	m ³ /h
CAE 508	8	2710	6500	15	2040
CAE 510	10	4040	9695	19	2720
CAE 513	13.5	5430	13030	23	3400
Omega 10	10	3840	9210	20	3000
Omega 14	14	4390	10530	20	4000
Omega 16	16	5830	13990	20	5000
Omega 20	20	6430	15430	20	6000
Omega 28	28	9900	23760	20	8500

* with ambient air at +30 °C and relative humidity of 70%

** pressure available without hot water battery, refer to the battery load losses (see §2.7.1)

- refrigerant gas: **R407C**
- refrigerant charge: see product information plate

2. Installation

2.1 Installation requirements

- **Install the appliance on a level base**, to avoid any overflows from the condensation tray,
- **Easy access to the appliance for maintenance and connections**,
Warning about the filter: leave 1 meter of free space around the appliance,
- **Place nothing in front of or on the blowing and suction grates**,
- **anti-vibration studs** (supplied) **must be installed** under the appliance,
- **For a swimming pool building with a high ceiling or visible roof frame**: destratification of the upper layers of the room = one or several fans with PVC blades **or** an air extractor with fresh air intake.
Warning! 230 V AC appliances = must be outside volume 1 (see under),



- **Risk of stratification:**
 - height of the room < 4 to 5 meters: mechanical ventilator unit or extractor,
 - height of the room > 5 to 8 meters: ceiling fans with large blades.
- **Building requirements:** swimming pool building = very damp room,
During building make sure that:
 - the materials used are compatible with a swimming pool environment,
 - the walls are sufficiently waterproofed and insulated to avoid condensation forming in the room when relative humidity reaches 60 to 70%,
 Light structure buildings (verandas, shelters...): there is no risk of deterioration of the structure, even in case of dew as they are designed to support this (even with a relative humidity of 70%),

•**Ventilation**, renewal of air:

- private pools: highly recommended,
- public pools: compulsory.

The air can be renewed by:

- a simple mechanical ventilation unit,
- a wall or roof extractor with fresh air intakes,



This ventilation ensures the hygienic renewal of air, the removal of any chloramines present in the air, and the elimination of excessively hot air, whilst contributing to the dehumidification of the room.

•Following French norm NFC 15-100, the appliance should be installed:

- Outside of area 1 (more than 2 metres from the edge of the pool) provided it is out of reach of potential splashes and protected by a dedicated 30 mA fuse,
- Outside of area 2 (more than 3.5 metres from the edge of the pool) if the above conditions are not satisfied.

2.2 Connection to surrounding air (only on CAE)

Leave sufficient space to install a blower plenum (unit distributing air to the blowing system) on top of the unit in order to orient the air flow, if possible towards the bay windows opening on the exterior.

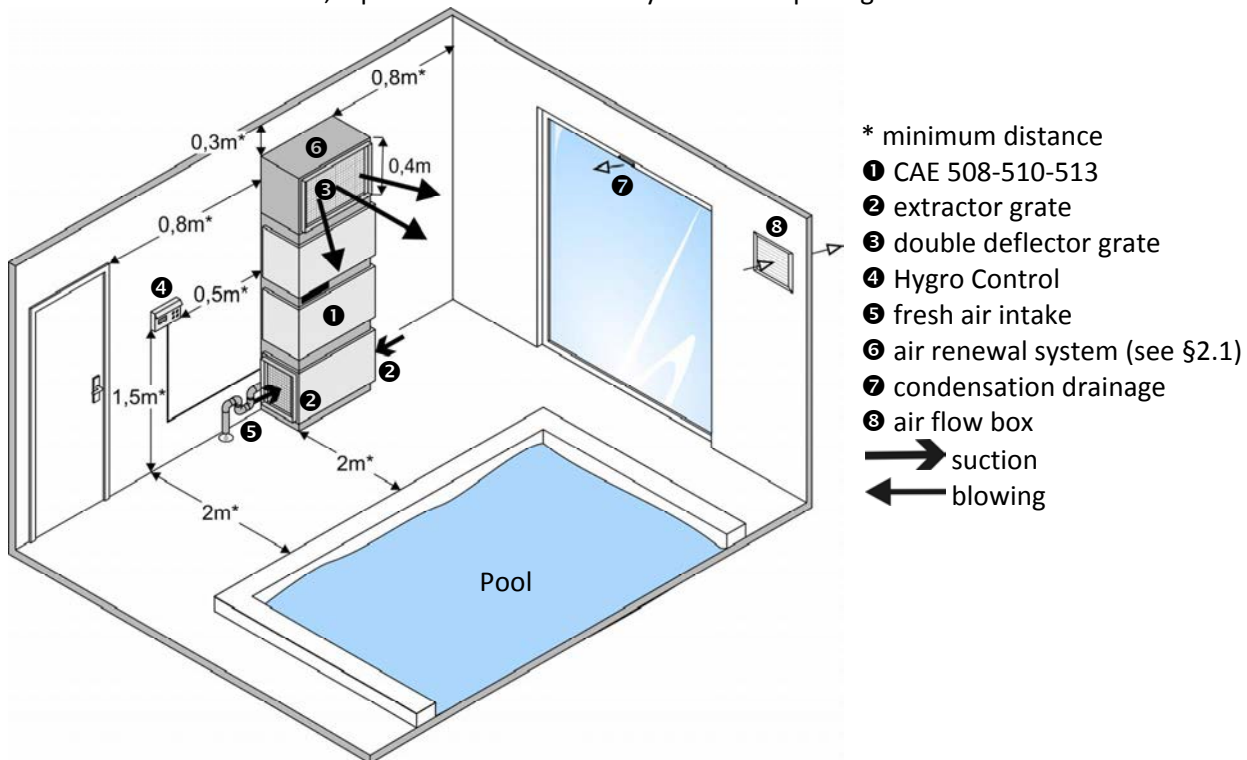

2.3 Connection through a dividing wall (only on CAE)

Plan 610 x 410 mm spaces in the wall between the technical room and the pool hall.

In the wall on the pool side, seal the standard grate frame on the bottom (without any equipotential connection to the sound trap) and the double deflector grate on the top (without any equipotential connection with the blower elbow).

On the technical room side connect the made to measure metalwork (sound trap, blower elbow) to the system and fit a foam joint for water tightness and to block any vibrations.

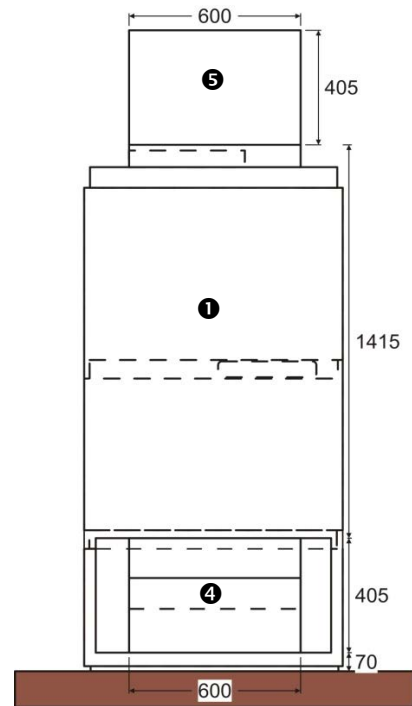
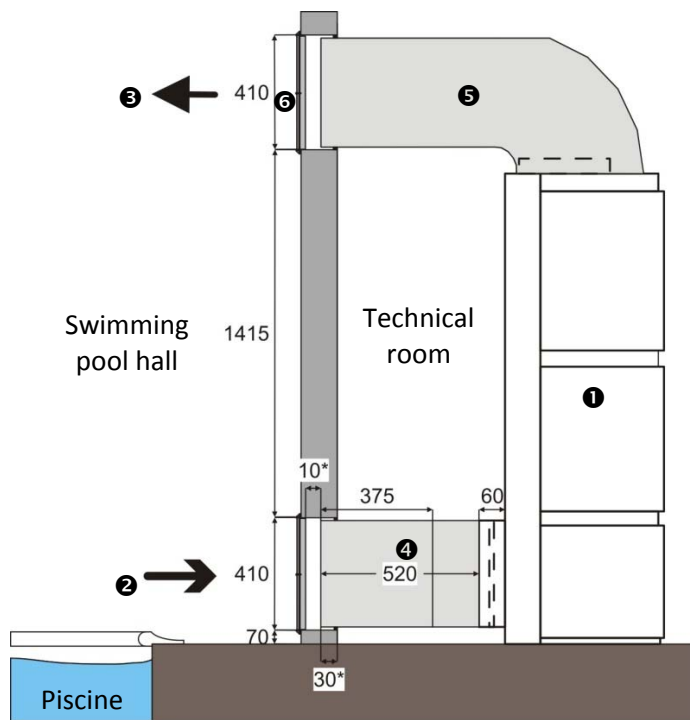

* minimum distance

Dimensions in mm, indications of values for installation using accessories for a CAE with mini-duct network (see Zodiac Pool Care Europe catalogue).

❶ CAE 508-510-513

❸ blowing

❺ blower elbow

❷ suction

❹ sound trap

❻ double deflector grate

2.4 Connection to a duct network

Install the appliance in a technical room that is protected from freezing.

Connect the intake and blower duct (or standard parts) respecting the air circulation direction:

		Frame dimensions				Minimum cross-section for blower and intake ducts	
Appliance	Unit	intake		Blowing		Rectangular	Circular
		behind	left - right	Front-rear-top	upper		
CAE 508	mm	825 x 405	559 x 465	405 x 350	X	400 x 400	400
CAE 510 513	mm	825 x 405	559 x 465	405 x 350	X	500 x 500	500
Omega 10-14	mm	1060 x 630	X	405 x 350		500x500	500
Omega 16-20	mm	1060 x 630	X	405 x 350		600x700	630
Omega 28	mm	1650 x 824	X	920 x 400		600x1000	800

 Cross section for a maximum length of 20 meters, air speed: 5 to 6 meters/second
 Average load losses by air flow direction change, 90° elbow or by T = 1 mm EC



- Plan a water drainage point at the low point for possible projection of water in the ducts.
- To ensure the correct operation of the system, the duct network must be sized according to the air flow delivered by the appliance (see table below). For very long or complicated networks please contact us.
- The blower grates must be fitted with registers for better air distribution.
- Plan sufficient leeway to allow for the removal of the filters on both sides of the extraction frames (2 of 525 x 615 mm on Omega 10-14-16-20 and 6 of 400 x 500 mm on the Omega 28).
- **Omega using inversed blower (vertical from the bottom):** requires a blower box to be built under the system (either using masonry if using in-ground ducts or using galvanized metal if there is ventilation space available underneath). This box should have a deflector to orient the flow to the different network blower points.
- **Intake box:** to be made to measure depending on the intake network configuration. Its design must meet sound insulation criteria (consider adding one or more sound traps depending on the appliance air flow).

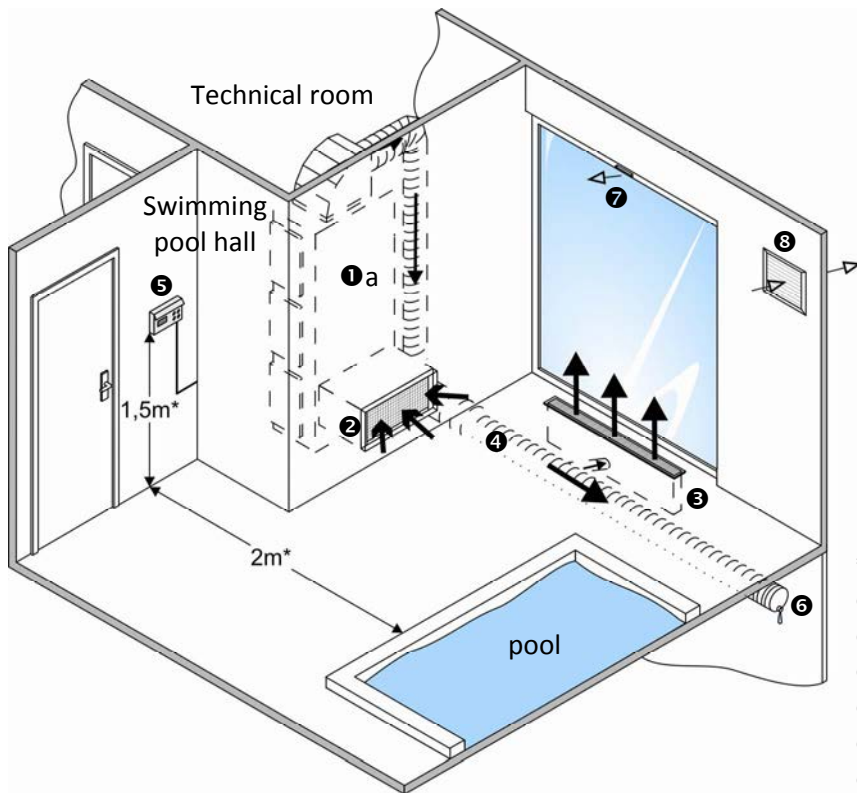

- * minimum distance
- ① a CAE 508-510-513
 - ① b Oméga 10-14-16-20-28
 - ② suction grid
 - ③ blowing grids + connector box
 - ④ duct
 - ⑤ Hygro Control
 - ⑥ duct exhaust
 - ⑦ fresh air intake
 - ⑧ sys air renewal system (see §2.1)
- suction
 blowing

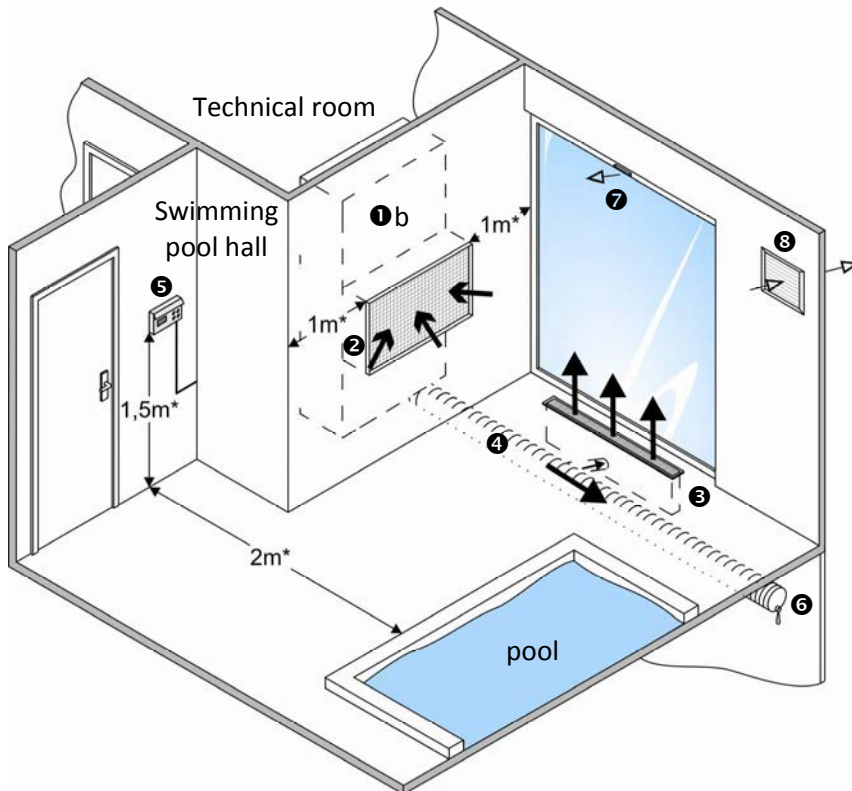

2.5 Connection of condensation drainage

The drainage is gravitational using $\varnothing 32$ piping (not supplied) fitted with a siphon system ① with a purge cap ②.

For placing the condensation drainage: see mark "A $\varnothing 26/34$ " § "dimensions" in the appendix.

Condensation drainage, from the front face the drainage is:

- on the right if drainage from the rear, but can be switched to the left, to do this:
 - unscrew joint ⑤ from joint ③,
 - unscrew joint ③ from elbow ④.
 - reassemble on the other side making sure it is watertight (adjust the length of the flexible tube to avoid pinching it).
- on the side opposite the drainage if it is lateral.

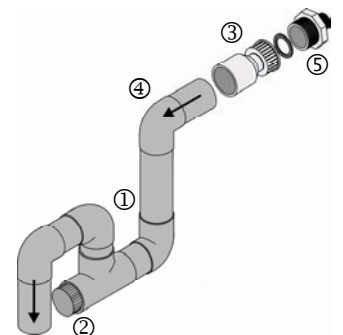

To the drain

2.6 Electrical connections

2.6.1 Voltage and protection

- The electrical supply must be provided through a protection and circuit breaking device (not supplied) complying with the standards and regulations in force in the country where it is installed,
- Electrical protection: 30 mA ground fault circuit breaker.



- **Acceptable voltage variation tolerance: $\pm 10\%$ (during operation),**
- **Electric cables must be fixed,**

2.6.2 Connections

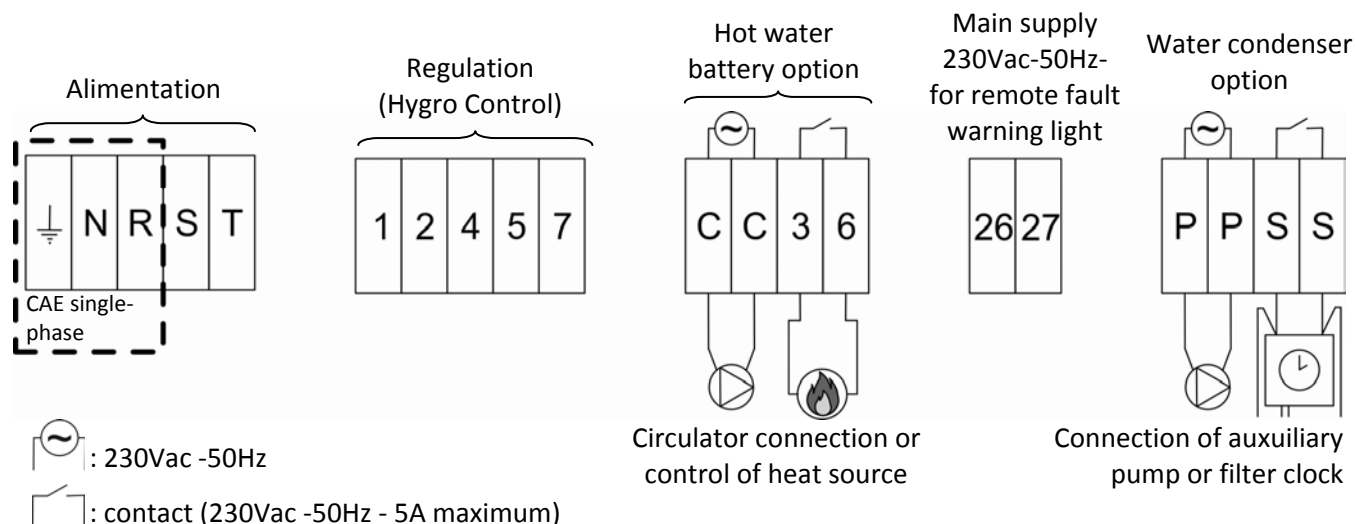

- **Loose terminals may cause the supply terminal board to overheat, and will void the warranty.**
- **The appliance must be earthed.**
- **Risk of electrical shock inside the device. Only a qualified and experienced technician must install the device cables. If the power cable is damaged it must be replaced by a qualified technician.**

2.6.3 Cable sizes

- Supply cable size: for cables of a maximum length of 20 metres (calculation basis: 5A/mm²), this must be checked and adapted depending on installation conditions.

Unit	Option	Voltage	Nominal power consumption	Maximum power consumption	Cable size	
			A	A	mm ²	
CAE 508 Single-phase	without option or hot water battery	230V-50Hz-	17.5	37.1	3 x 6	3G6
	Extra heating 4.5 kW	230V-50Hz-	32.7	48.5	3 x 10	3G10
CAE 508 three-phase	without option or hot water battery	400V-50Hz-	5.3	8	5 x 2.5	5G2.5
	Extra heating 9 kW	400V-50Hz-	18.5	22.5	5 x 6	5G6
CAE 510 three-phase	without option or hot water battery	400V-50Hz-	8.5	14.5	5 x 4	5G4
	Extra heating 9 kW	400V-50Hz-	21.5	29	5 x 6	5G6
	Extra heating 18 kW	400V-50Hz-	34.5	43.5	5 x 10	5G10
CAE 513 three-phase	without option or hot water battery	400V-50Hz-	11	17	5 x 4	5G4
	Extra heating 9 kW	400V-50Hz-	24	31.5	5 x 10	5G10
	Extra heating 18 kW	400V-50Hz-	37	46	5 x 10	5G10
Omega 10	without option or hot water battery	400V-50Hz-	7.6	13	5 x 2.5	5G2.5
	Extra heating 9 kW	400V-50Hz-	20.6	27.5	5 x 6	5G6
Omega 14	without option or hot water battery	400V-50Hz-	9	16	5 x 4	5G4
	Extra heating 9 kW	400V-50Hz-	22	30.5	5 x 6	5G6
Omega 16	without option or hot water battery	400V-50Hz-	12	18.5	5 x 4	5G4
	Extra heating 18 kW	400V-50Hz-	38	47.5	5 x 10	5G10

	Option	Voltage	Nominal power consumption	Maximum power consumption	Cable size	
Unit			A	A	mm ²	
Omega 20	without option or hot water battery	400V-50Hz-	16.4	20.1	5 x 4	5G4
	Extra heating 18 kW	400V-50Hz-	42.4	49	5 x 10	5G10
Omega 28	without option or hot water battery	400V-50Hz-	19	23.8	5 x 6	5G6
	Extra heating 18 kW	400V-50Hz-	45	53	5 x 16	5G16

2.6.4 Hygro Control connection

i Hygro Control = digital display hygro-thermostat = display and setting of pool hall temperature* and humidity

- for installation location: see §2.2, §2.3, §2.4 and refer to § 2.1,
- correctly influenced by the swimming pool room air,
- connect to terminals on the electric box.

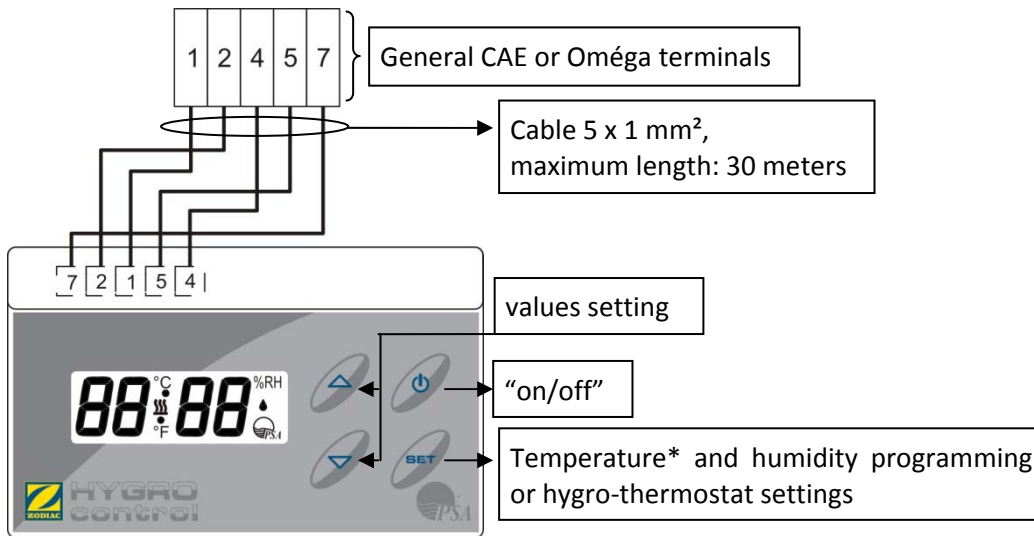

- Mains supply 12Vac-50Hz- between terminals 4 and 5,
- The numbering of the terminals must be respected,
- Do not put these cables into the same duct as other 230 V or 400 V to avoid any risk of interference of the signals,
- Obstruct the place where the cable emerges from the wall or seal it by using materials other than silicone and silicone-based materials, in order to avoid any arrival of air exterior to the room through the duct or dividing wall.

Technical specifications

Admissible room temperature	°C	0-55	
Admissible humidity level	%	0-90	
Voltage	Vac	12	
Maximum voltage	Vac	24	
Protection index	IP	20	
Dimensions: width / height / depth	mm	120 x 70 x 28	
Hysteresis	Humidity	%	4
	temperature	°C	1

Display

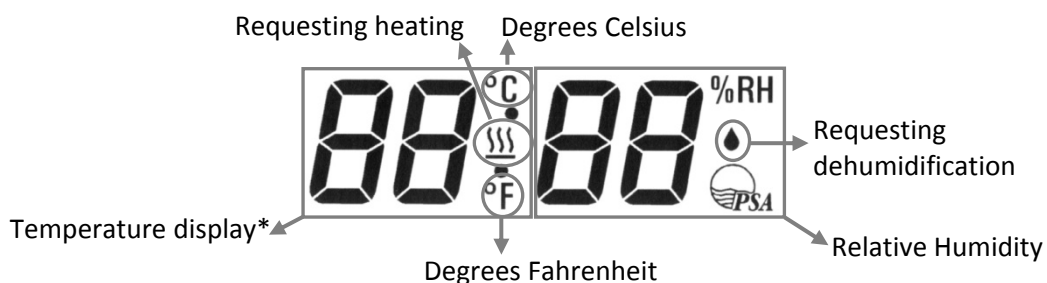



* Only if your appliance is fitted with the hot water battery option, or extra electric heating.

Hygro Control display	Hygro-thermostat	Hygrostat	Thermostat
On standby	---	--	--
Active	28°C 65%RH	65%RH	28°C

By default: display of the temperature and/or desired relative humidity.

Display of the ambient temperature and/or humidity by pressing once, "°C" and/or "%RH" blink. To exit, press , or wait 10 seconds.

Starting up and stopping the appliance

Press for 5 seconds.

Locking/unlocking the keyboard

To lock and unlock the keyboard:

- Hygro Control must be **active**,
- press and simultaneously for 3 seconds,
- the message is displayed or is removed.

Adjusting the reference values

- Hygro Control must be **active**,
- press for 3 seconds, the modifiable value blinks,
- use or to set the value,
- press to validate,
- and then to exit.

Value range	minimum	maximum	Comfort setting
Humidity	55%	70%	65%
Temperature	5 °C	32 °C	28°C

If the keyboard is not used for 30 seconds, the setting will be abandoned and the last (non validated) setting will not be taken into account.

Test mode / Manual override

To force the appliance to operate for 30 minutes, even if the pool hall conditions do not trigger the request:

- Hygro Control must be **active**,
- press on for 3 seconds, a value blinks,
- press again for 10 seconds,
- all the digits light , or and the appliance starts up.

To quit this mode, press the button for 5 seconds.

Parameter setting in hygro-thermostat or hygrostat mode

Hygro Control shipped with the setting for hygro-thermostat mode for appliances with the heating option for hygrostat mode for devices without the heating option. This setting must be changed if a heating option is added or removed.

- Hygro Control must be **on standby**,
- press and for 3 seconds : (hygro-thermostat mode),
- press or to select the function: (hygrostat mode), (thermostat mode)
- validate by pressing .

2.7 Connecting the options

2.7.1 Hot water battery

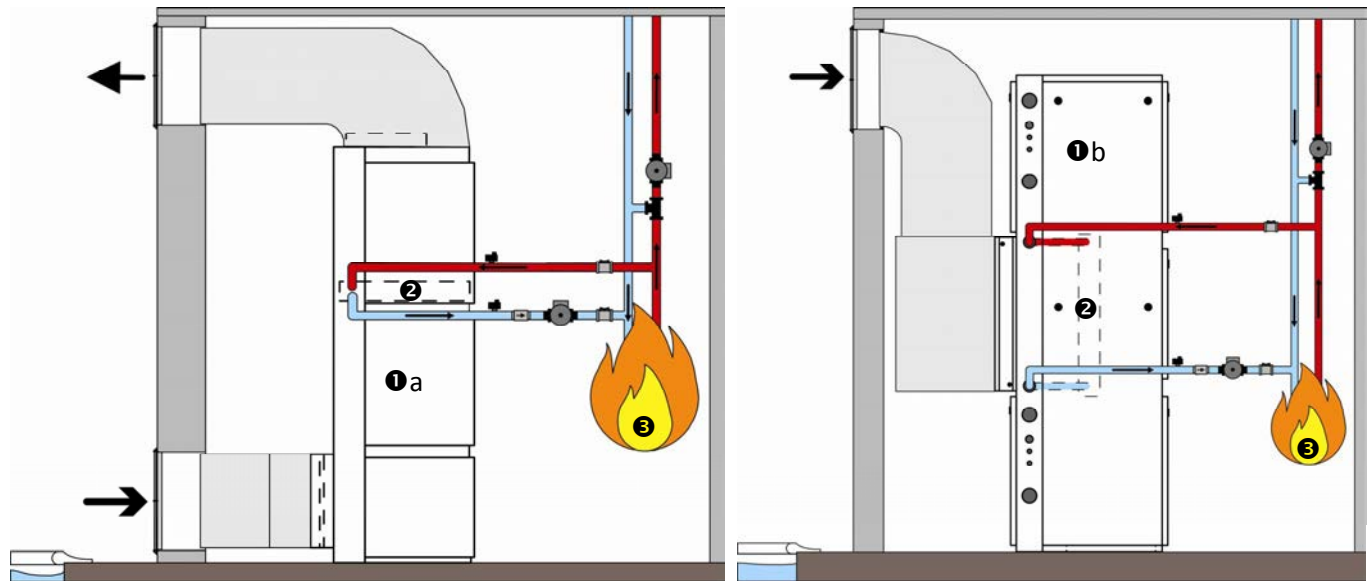

1a CAE 508-510-513

1b Omega 10-14-16-20-28

2 hot water battery

3 heating source

← blowing

→ suction

Automatic purge

Circulator

Check valve or solenoid valve

Shut-off valve

Primary Unit	Power		Water flow rate		Water load loss		Air load loss	
	90/70°C	45/40°C	90/70°C	45/40°C	90/70°C	45/40°C	90/70°C	45/40°C
	kW		m ³ /h		mCE		Pa	
CAE 508	23	5.9	1	1.03	1.25	1.54	30	28.5
CAE 510	35	9.8	1.6	1.7	1.9	2.3	50	47.3
CAE 513	41	11.6	1.9	2.01	2.5	3.12	72	67.7
Omega 10	24	9.5	1.2	1.66	0.46	0.93	18	17.8
Omega 14	34	11.6	1.5	2.03	0.7	1.34	30	27.9
Omega 16	42	13.5	2.1	2.35	1.41	1.76	42	39.8
Omega 20	53	15.2	2.35	2.64	0.51	2.17	57	53.5
Omega 28	76	23	3.3	3.98	1.1	1.41	/	39.1

Power restituted to the air at 27°C, entering the hot water battery.



- Connection to the primary circuit: front any valve or pump.
- Water temperature input to the hot water battery: 45 °C minimum, 90°C maximum.
- Maximum pressure water battery circuit: 3 bars.

2.7.2 Titanium water condenser

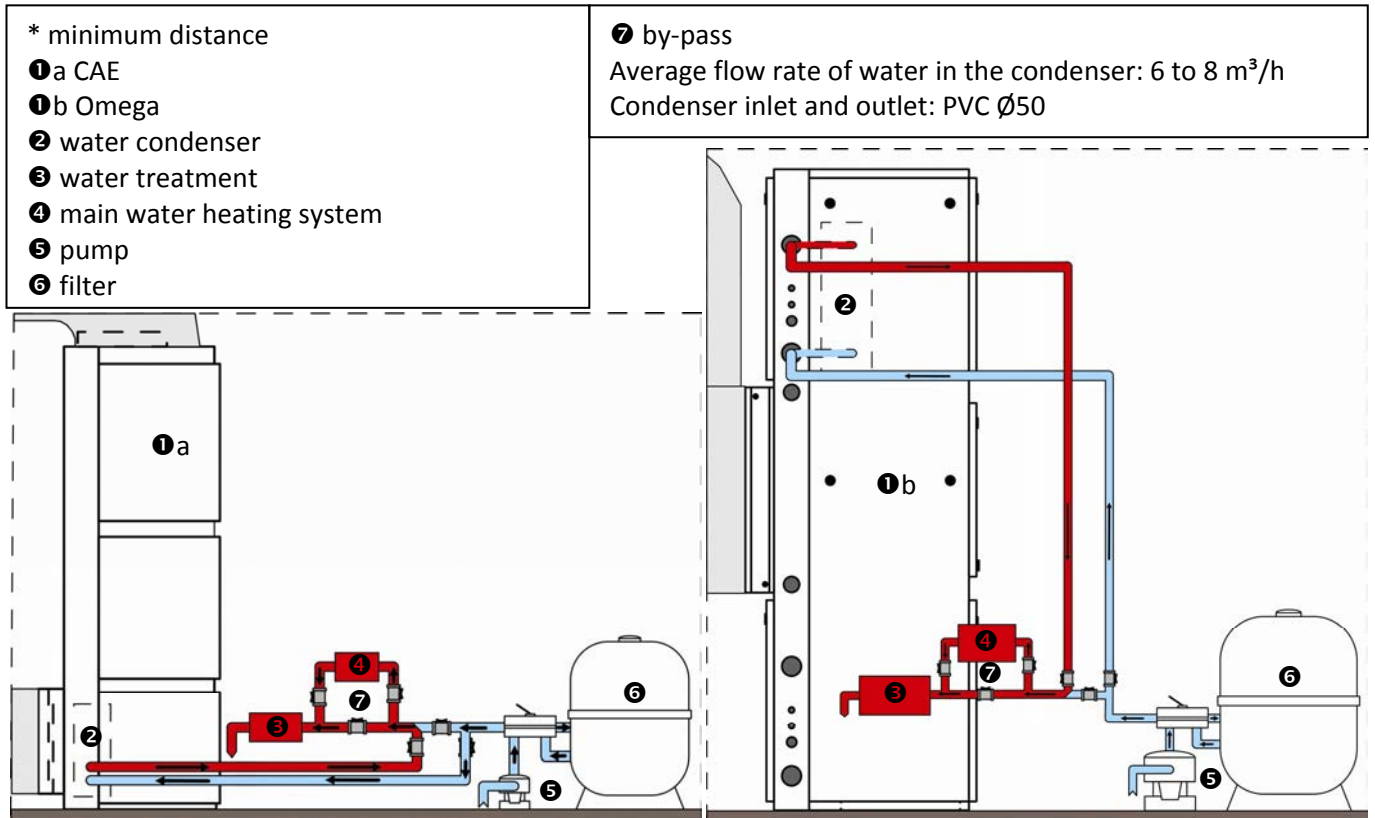

3. Operation

3.1 Different command panel set ups

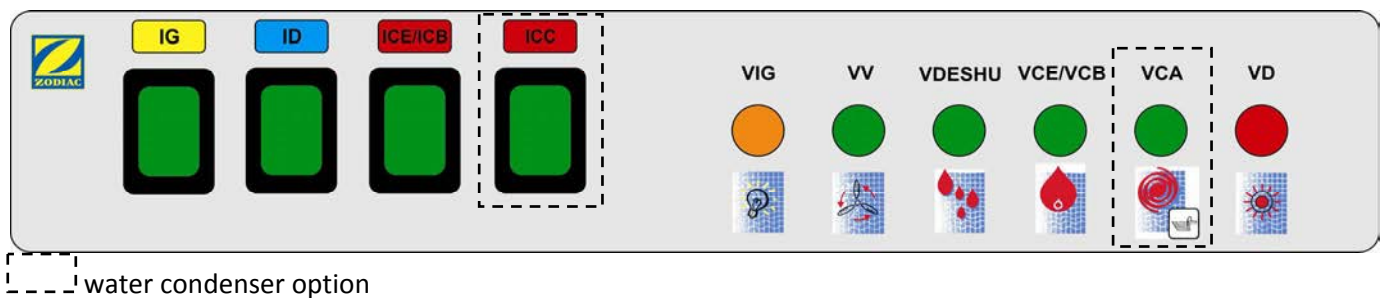

IG	Main switch	VV	Ventilation (green)
ID	Dehumidification switch	VDeshu	Dehumidification (green)
ICE/ICB	Heater switch	VCE/VCB	heating (green)
ICC	Water condenser switch	VCA	Water condenser (green)
VIG	Main switch (orange)	VD	Fault (red)

3.2 Starting the appliance

- Power on the appliance (by switching on the general terminal board),
- Only for three-phased appliance: when the dehumidifier is switched on, check the status of the phase controller (KA4):
 - None of the indicators are lit = no power supply,
 - Green and orange indicators are lit = normal operating conditions,
 - Only green indicator lit = power supply is ok but phase inversion issue or missing phase. Cut off the power supply and invert two phases directly on the appliance connection terminal board. If the orange indicator does not light up after the phase inversion, check for the presence of the three phases on the phase order controller KA4.

This operation must be only be carried out by a qualified professional.

The phase order controller protects the compressor. It's forbidden to invert phases:



- on the power contactor (KM1 and/or KM2)
- on the compressor
- on the ventilator
- on the thermal protection
- on the phase order controller

- Activate the switches depending on needs and options(s):

Trigger(s) / switches	IG	ID	ICE/ICB	ICC
Dehumidifier	X	X		
Dehumidifier + air heating*	X	X	X	
Dehumidifier + water condenser	X	X		X
Dehumidifier + air heating* + water condenser	X	X	X	X

* extra heating or hot water battery option

- start up an appliance with options, see also §3.5,
- set the humidity and temperature on the Hygro Control so that it triggers dehumidifying and / or air heating (optional), see §2.6.4.



When the "ECP 600" regulator is switched on ventilation is active for 5 minutes. This also occurs if the appliance is powered on and the "on/off" switch of the Hygro Control delivered with the appliance is used.

3.3 Checks

In the Hygro Control comfort model (see §2.6.4)

- check that hot air is coming out of the blower grates,
- check that the appliance is draining condensation.

3.4 Adjusting the duct network

Set the air flow by adjusting the grate dampers (recommended speed \approx metre/second) identically on all the blower grates.

3.5 Options starting up

The heating options are operational from 4°C surrounding air temperature.

3.5.1 Extra heating

- starting up Hygro Control and adjust the thermostat to between 26 and 28°C (maximum 30°C), in general choose an air temperature 1 to 2°C higher than the pool water temperature,



if your pool has a cover (shutter or bubble sheet type, etc.), you can lower the room temperature when it is in place (by adjusting the thermostat to about 20°C) and raise the pool hall temperature before removing the cover.

- check that with the "VI/VP" switch on "VI", and no dehumidification or defrosting cycles in progress:
 - the fan stops operating, after post-ventilation of 3 minutes when the reference room temperature on the pool room thermostat is lowered,
 - in the event of abnormal overheating, the appliance shuts down the heating option automatically, by shutting off the heating elements and keeping the ventilation operational (for as long as a heating request is active).

This safety device has two levels of triggering:

- 1) by "THS" safety thermostat if the T°C is $> 65^{\circ}\text{C}$ (it is automatically reset),
- 2) if the temperature continues to increase, the second positive "THSM"  safety thermostat puts the appliance into safety mode.
=> reset it manually (with power off), after having checked that the appliance air flow is correct (with the "VI/VP" switch on "VP"), that the grates are not obstructed, that the filter is not clogged, and the fan is not defective

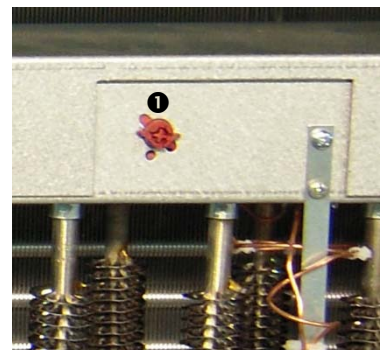

3.5.2 Hot water battery

- Supply the battery with hot water at 50 °C minimum from the heat source (boiler, heat pump, geothermal energy, solar heating), installation must be carried out by a qualified technician, using a circulator (not supplied) which will be powered by terminals C-C on the electrical terminal board.

 Insulate the hot water battery hot water pipes between the heat source and the appliance (for the purpose of limiting calorie loss).

- connection to a ZPCE double circuit gas boiler: connect the terminals 3-6 of the terminal board, to terminals 3-6 of the boiler terminal board,

 Terminals 3-6 can also ensure a heat source control function (see §2.6.2).







- adjust the thermostat between to 26 and 28°C (maximum 30°C), in general set the air temperature 1 to 2°C higher than the pool water temperature,

 If your pool has a cover (shutter or bubble sheet type, etc.), you can lower the room temperature (by adjusting the thermostat to about 20°C) when it is in place and raise the pool hall temperature before removing the cover.

- a post-ventilation runs for 3 minutes when the reference temperature is reduced on the thermostat located in the pool hall (with the “VI/VP” switch on “VI”, without any dehumidification or defrosting cycles in progress): check that the circulator stops.

 **Warning - low temperature:** if the dehumidifier hot water battery is not supplied by a boiler, but by an aero-thermal or a geothermal system, the heating circuit water will be at a maximum temperature of 50-40°C. The power of the battery will then be considerably lower (3 to 4 times less) than the nominal power given for water at 90-70°C. If the power of the battery is lower than the heating needs of the room, plan for additional heating by radiator, heated floor or fan convector.

3.5.3 Titanium water condenser

- connect the intake and output to the filter using a by-pass, according to the markings on the appliance (before the pool water treatment system), see §2.7.2,
- Adjusting the by-pass for the water condenser  :
 - open valve  half way
 - open valves  and  completely
- plan to shunt the filter clock from the S-S terminals on the appliance electrical terminal board,
- in the case of a hydraulic connection with pump that is independent of the filtering system, plan to power this pump using the P-P terminals on the appliance terminal board (maximum power: 60W with 230V AC, otherwise relay the power supply from an extra electric contactor),
- starting up: set the “TH” digital display thermostat fitted inside the electrical box:
- press “SET” to display the current reference value (factory preset at 27°C, thus the thermostat output will be activated when the pool room temperature will rises above 29°C and deactivated if the temperature drops below 27°C): the “out 1” LED blinks (hysteresis = 2°C),
 - press  or  (possible range values: 25°C minimum and 45°C maximum),
 - press “SET”, or do not operate for 15 seconds, to confirm.
- check that the filter pump starts when the adjustment of this digital display thermostat is reduced to below the surrounding temperature.
- check that the « VCA » indicator lights when the thermostat reference value is lowered. By default, check that the filter pump is operational and sufficiently irrigates the water condenser (see by-pass adjustment).
- when the water condenser option is operational (VCA indicator on), check that the « EV » solenoid valve is powered from terminals E and V (230V ac) on the appliance terminal board. If this is not the case adjust the by-pass so that there is a sufficient flow of water in the condenser to activate the flow controller fitted at the output of the water condenser (this safety device is connected between terminals I and D, see the electric wiring diagram in the appendix).

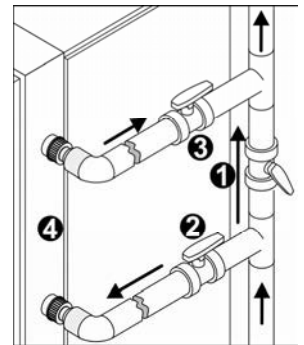

4. Maintenance

4.1 Maintenance instructions



A general servicing of the appliance is recommended both when winterizing and when restarting in order to ensure the proper operation of your heat pump, to preserve its performance and to prevent potential failures.

Servicing costs will be borne by the user.



**Appliance powered off and unplugged from power supply!
The appliance must have filters fitted when operating.**

4.1.1 Monthly checks

- check visually that the condensation is drained.
- check for clogging in the filter:
 - wash the filter with warm soapy water,
 - rinse it abundantly and dry it,
 - replace it if necessary.

4.1.2 Quarterly checks

- Check the tightness of the centrifuge fan belt: push the belt down between the two pulleys, it should yield about 1 cm.

4.1.3 Annual checks

- check that the electric cable connections, contactors are correctly tightened,
- check that each command relay, power switch and electronic protection device is operational,



On three-phase appliance, via the phase controller (KA4), any modification of the order of phases on the distribution network or on the existing electrical installation is detected. The appliance then goes into fault mode (Led A1 and A3 ON, and orange light OFF for KA4), refer on §5.1.

- check the adjustment and operation of the Hygro Control and the water condenser thermostat if necessary clean the dust inside it using a jet of air,
- clean the whole unit with a slightly damp cloth,
- check the cleanliness of the condensation drainage tray and tube,
- check the condition of the insulating foam on the technical compartment.
- check the movement of the centrifuge ventilator blades (the bearings are greased permanently and need no maintenance),
- check that the batteries are clean. If necessary, clean them using a hard silk brush, a vacuum cleaner or a jet of compressed air. Rinse using cold water under pressure taking care to avoid splashing water on the ventilator motor.

4.2 Additional recommendations

in relation to the Pressure Equipment Directive (PED-97/23/CE)

4.2.1 Installation and maintenance

- the unit may not be installed close to combustible materials, or the air duct inlet of an adjacent building .
- with some devices, it is essential to fit protection grids if the unit is installed in an area with uncontrolled access.
- during installation, troubleshooting and maintenance, pipes may not be used as steps: the pipe could break under the weight, spilling refrigerant and possibly causing serious burns.
- when servicing the appliance, the composition and state of heat carrying fluid must be checked, as well as the absence of any refrigerant.
- during the annual unit sealing test in accordance with applicable legislation, the high and low pressure switches must be checked to ensure that they are securely fastened to the coolant circuit and that they cutoff the electrical circuit when tripped.
- during maintenance work, ensure there are no traces of corrosion or oil around cooling components.
- before beginning work on the cooling circuit, stop the device and wait for a few minutes before fitting the temperature and pressure sensors. Some elements such as the compressor and piping may reach temperatures in excess of 100°C and high pressures with the consequent risk of severe scalding.

4.2.2 Troubleshooting

- all soldering work must be carried out by a someone qualified to do so.
- replacement pipes must always be made of copper in compliance with standard NF EN 12735-1.
- leak detection; pressure test:
 - never use oxygen or dry air, risk of fire or explosion,
 - use dry nitrogen or the mixture of nitrogen and refrigerant indicated on the information plate,
 - the test pressure for both the high and low pressure circuits must not exceed 20 bar and 15 bar in the case the device is equipped of the manometer option.
- the high pressure circuit pipes are made of copper and have a diameter equal to or greater than 1''5/8. A certificate as indicated in §2.1 in compliance with standard NF EN 10204 will be requested from the supplier and filed in installation technical documentation.
- technical data relative to the safety requirements of the various applicable directives must be indicated on the information plate.
- **This data must be recorded in the installation instructions for the device which are included in the installation technical file: model, code, serial number, maximum and minimum OT, OP, year of manufacture, EC label, manufacturer's address, refrigerant and weight, electrical parameters, thermo-dynamic and acoustic performances.**

4.3 Spare parts

Spare parts		Item number	Representation
Hygro Control sensor		WCE03431	
Filter			
CAE ambiance	375 x 445 x 20 mm (x2)	WSD01908*	
CAE lateral	555 x 455 x 23 mm	WSD01909	
CAE rear	788 x 400 x 23 mm	WSD01910	
Omega 10-14-16-20	615 x 525 x 25 mm (x2)	WSD01916*	
Omega 28	547 x 400 x 22 mm (x6)	WSD03350*	
Fan belt	CAE Omega 10-14-16	WGA02968	
	Omega 20	WGA02969	
	Omega 28 (x2)	WTR02357*	

* Reference for one part

4.4 Recycling the product





This symbol means that the equipment must not throw it into your household waste. It will be collected selectively so that it can be reused, recycled or recovered. Any substances it may contain which are potentially dangerous to the environment will be eliminated or neutralised.

Enquire with your retailer for the conditions that apply to the recycling of your product.

5. Troubleshooting

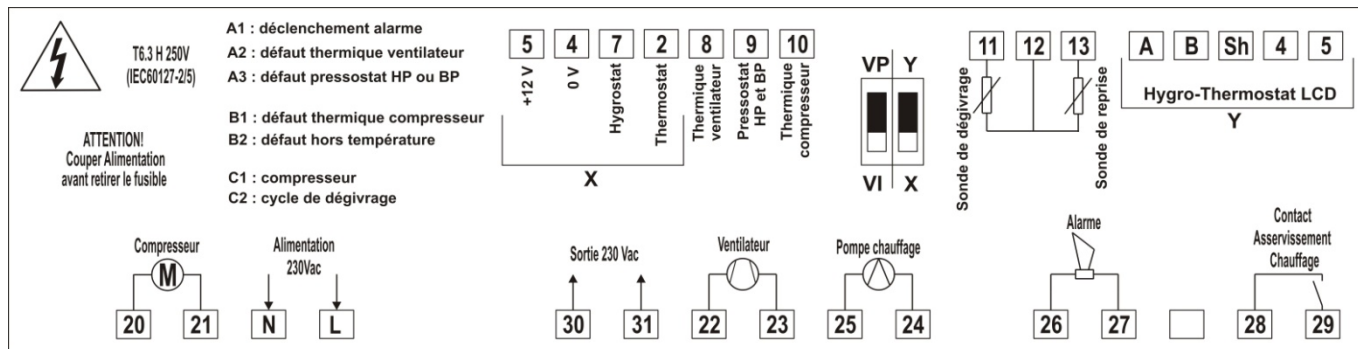
5.1 Status and faults in the ECP 600 settings



Terminals	Description
N - L	mains-supply 230Vac-50Hz to the ECP600 regulator
20 - 21	output from compressor supply 230 Vac -50Hz
30 - 31	230Vac-50Hz output (used with the water condenser option) and protected by the ECP600 fuse
22 - 23	ventilator 230Vac-50Hz output
25 - 24	output for circulator hot water battery option 230Vac-50Hz
26 - 27	output alarm report 230Vac-50Hz
28 - 29	output contact "NO" (without polarity) control of heat source hot water battery option
11 - 12 - 13	Input control sensor type PTC (inlet or defrost)
4 - 5	power supply 12Vac-50Hz
7	input 6Vac-50Hz given by the hygrostat function (request active if 6Vac-50Hz between 7 and 4)
2	input 6Vac-50Hz given by the thermostat function (request active if 6Vac-50Hz between 2 and 4)
8	input 12Vac-50Hz fan heat fault (shunted not active) (fault active if 0Vac-50Hz between 8 and 4, LEDs A1 and A2 are ON)
9	input 12Vac-50Hz faults BP and/or HP, and/or phase order (three-phase appliance) (fault active if 0Vac-50Hz between 9 and 4, LEDs A1 and A3 are ON)
10	input 12Vac-50Hz compressor heat fault (shunted not active) (fault active if 0Vac-50Hz between 10 and 4, LEDs A1 and B1 are ON)
Hygro-Thermostat LCD A-B-Sh-4-5	Not used
 switch VI/VP	<p>"intermittent ventilation" (standard setting) or "permanent ventilation" (to permanently circulate the pool hall air) The ventilation is active when:</p> <ul style="list-style-type: none"> - dehumidification is triggered, - a defrosting cycle is started, - pool hall air heating is triggered, - active for at least 5 minutes in one hour without any of these triggers. <p>On VP, the compressor starts after a delay of 1 minute.</p>

Leds	Description
A2 fan heat fault	Triggering of auxiliary contact Q1.1 for thermal relay Q1
A3 high or low pressure switch fault	triggering HP and/or LP switch and/or phase order relay KA4 (only on three-phased appliance) <ul style="list-style-type: none"> - HP : check that the ventilator is operational, that the air filter is clean and the belt is tight enough, - LP: insufficient gas, call a specialist, - KA4: check for the presence of the 3 phases, if so, see §3.2.
B1 compressor heat fault	Triggering of auxiliary contact Q2.1 for thermal relay Q2

Leds	Description
B2 temperature range fault	- restart sensor is out of order If the returns to within its operating range: - there is a 10 seconds delay before the fault is cleared, - there is a minute delay before restarting the compressor (if a dehumidification request is still active)
C1 compressor	continuous = compressor is operating blinking = temporisation in process
C2 defrosting cycle	- cooling circuit temperature < than -5°C or > than 40°C, - a defrosting cycle is in progress (temperature is >-5°C). The compressor is stopped and ventilation is maintained, - the defrosting sensor is out of order. The defrosting cycle stops when the temperature of the sensor goes over 3.2°C. In all cases, if the ventilator is active before the triggering of this fault, ventilation is maintained. If the sensor returns within its operating range: - there is a delay of 10 seconds before the fault is cleared, there is a minute delay before the compressor restart (if a dehumidification request is still active)

5.2 FAQ

Why is my appliance draining water?	Your appliance gives off water, called condensation. This water is the humidity your dehumidifier condenses to dry the air.
Why are my French windows covered with water whilst my appliance is dehumidifying?	This is the dew point, which means the moment when the water vapour contained in the air will change states when in contact with a cold surface. This is the phenomenon of condensation. This does not mean your appliance is not working. This phenomenon is normal, because of the presence of humidity in the air (65% humidity in comfortable conditions), and a cold outside temperature.

6. Product registration

Register your product using our website:

- Be among the first to be informed of new Zodiac products and special offers,
- Help us to constantly improve our product quality.

Australia – New Zealand	www.zodiac.com.au
South Africa	www.zodiac.co.za
Europe and rest of the world	www.zodiac-poolcare.com

7. Conformity certificate

Z.P.C.E. declares that the following products or ranges:

Special pool dehumidifier: CAE 508-510-513 and Oméga 10-14-16-20-28

are in compliance with the provisions of:

- **Electromagnetic compatibility directive 89/336/EEC**
- **Low voltage directive 73/23/EEC, as amended by 93/068/EEC**
- **The following harmonised standards have been applied: EN 60335.2.40**





Notes

A series of horizontal dashed lines for writing notes, arranged in a regular grid pattern across the page.

Electric diagram

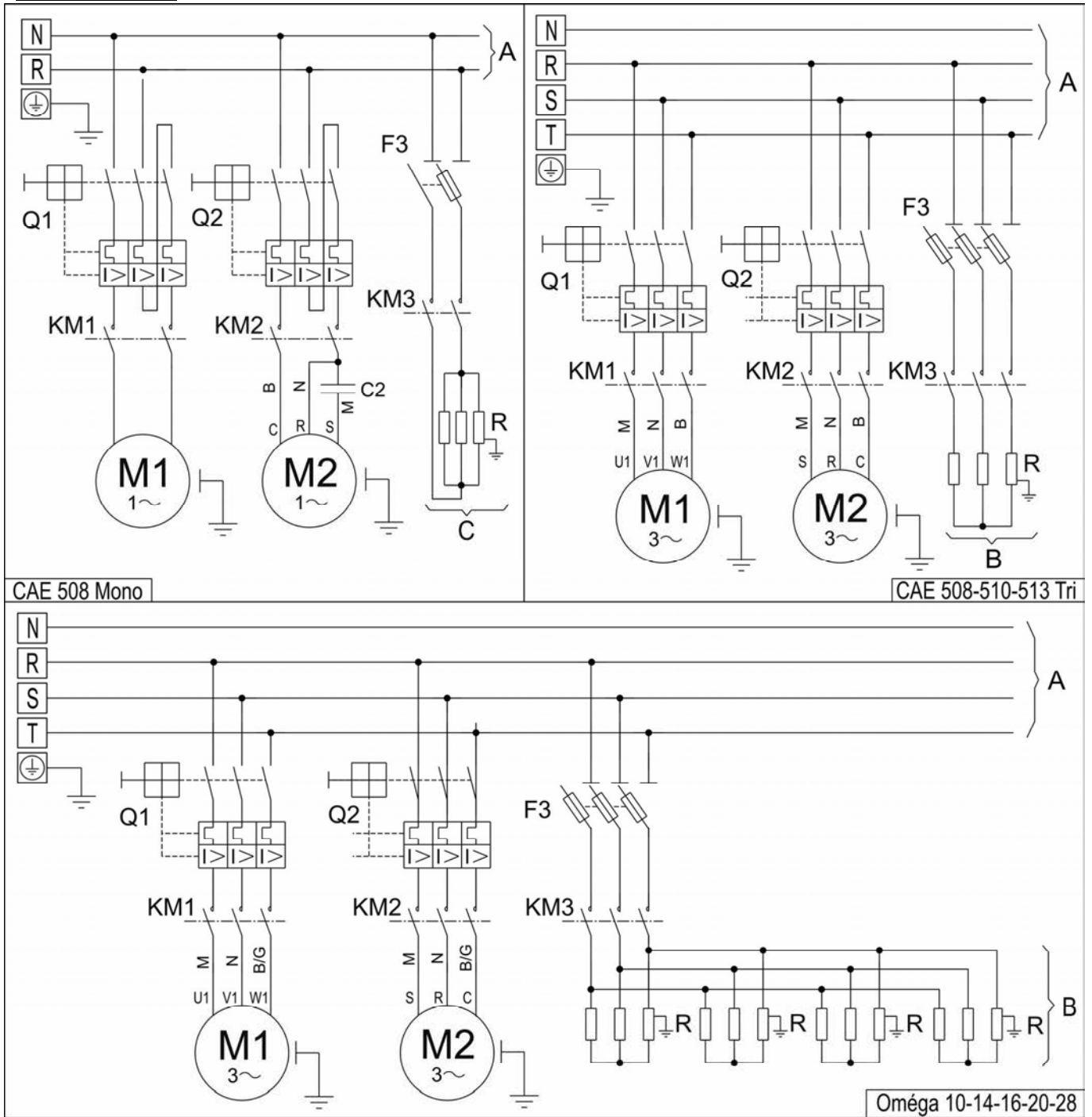
Power diagram



N-R	Single phase main supply 230Vac-1N-50Hz
N-R-S-T	Three phase main supply 400Vac-3N-50Hz
	Terre
5-7-2-4-1	Connection of Hygro Control (sie §2.6.4)
26-27	supply (230 V AC -50 Hz) for remote fault warning light or relaying
3-6	control of heating for ZPCE type boiler or an existing heating system
C-C	supply (230Vac-50Hz) for battery circulator or used for electric logic of the heating option by electric heating
S-S	control for filtering clock
P-P	supply for controlling the filtering pump
A	Control circuit main supply (see control diagram)
B (Oméga)	Extra heating 9kW (with 6x1.5kW on Y), 13.5kW (9x1.5kW on Y), 18kW (12x1.5kW on Y)
B (CAE)	Extra heating 9kW or 18kW (except CAE 508)
B1	automate de commande ECP 600
C	Extra heating 4.5kW
C2	Compressor capacitor
CD	Flow rate controller
E1	High pressure switch
E2	Low pressure switch
EV	Water condenser circuit solenoid valve
F1	General main fuse 6.3A – 5x20
F2	Fuse T=6.3A – 5 x 20
F3	Tripolar or phase-neutral cut circuit
IG	Main switch
ID	Dehumidification switch
ICE	Extra heating switch
ICB	Hot water battery switch
ICC	Water condenser switch
KA3	command relay water condenser option
KA4	Phase order relay on three-phase appliance (CP) (extinct LED indicate a fault)
KA4.1	KA4 relay contact “Normally Open”
KM1	Ventilator power contactor
KM2	Compressor power contactor
KM3	Extra heating power contactor
M1	Ventilator motor (230Vac/50Hz or 400Vac/50Hz)
M2	Compressor motor (230Vac/50Hz or 400Vac/50Hz)
OAE	Extra heating option
OCE	Water condenser Titanium option
Q1	Motor ventilator thermal protection adjustable
Q2	Motor compressor thermal protection adjustable
Q1.1	Ventilator thermal auxiliary contact
Q2.1	Compressor thermal auxiliary contact
R (Oméga)	Heating pins assembled on Y
R (CAE)	Multistage Extra heating (heating resistor 1x4.5kW or 2x4.5kW or 4x4.5kW)
SD1	Air inlet sensor (black sheath)
SD2	Defrost sensor (grey sheath)
SD3	Thermostat of regulation sensor (white sheath)
TH	thermostat of regulation to digital display
THS	High limit thermostat (automatic reset)
THSM	Positive high limit thermostat (manual reset)
VD	Alarm lamp (outside)
VIG	Main switch lamp
VDéshu	Dehumidification lamp
VCE	Extra heating lamp
VCB	Hot water battery lamp

VV	Ventilation lamp
VCA	Water condenser lamp
N	Black
B	Blue
M	Brown
G	grey

Dimensions

without option

weight	CAE 508	CAE 510	CAE 513	Oméga 10	Oméga 14	Oméga 16	Oméga 20	Oméga 28
Kg	228	235	240	342	344	346	397	505

CAE 508-510-513

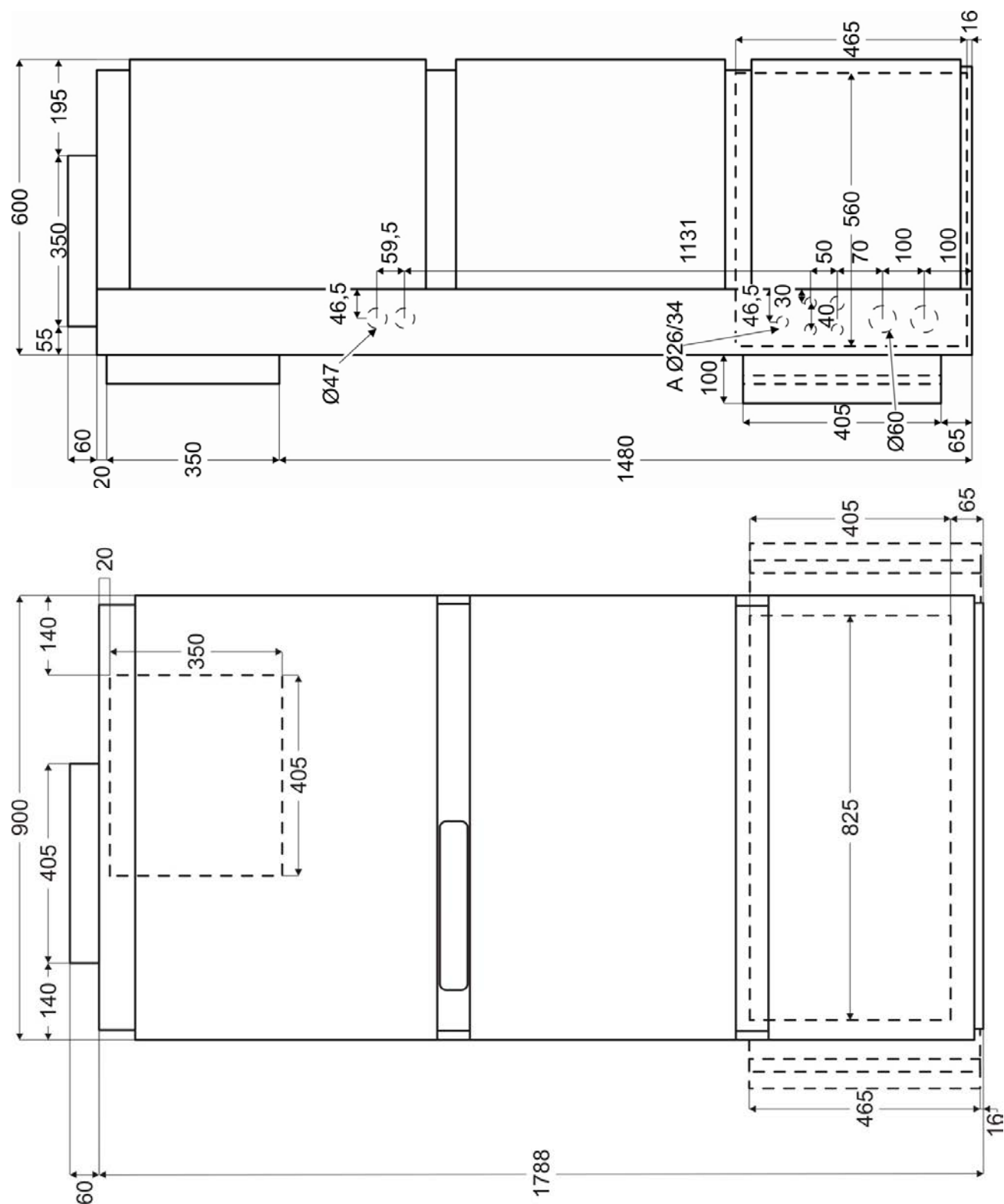

Oméga 10-14-16-20

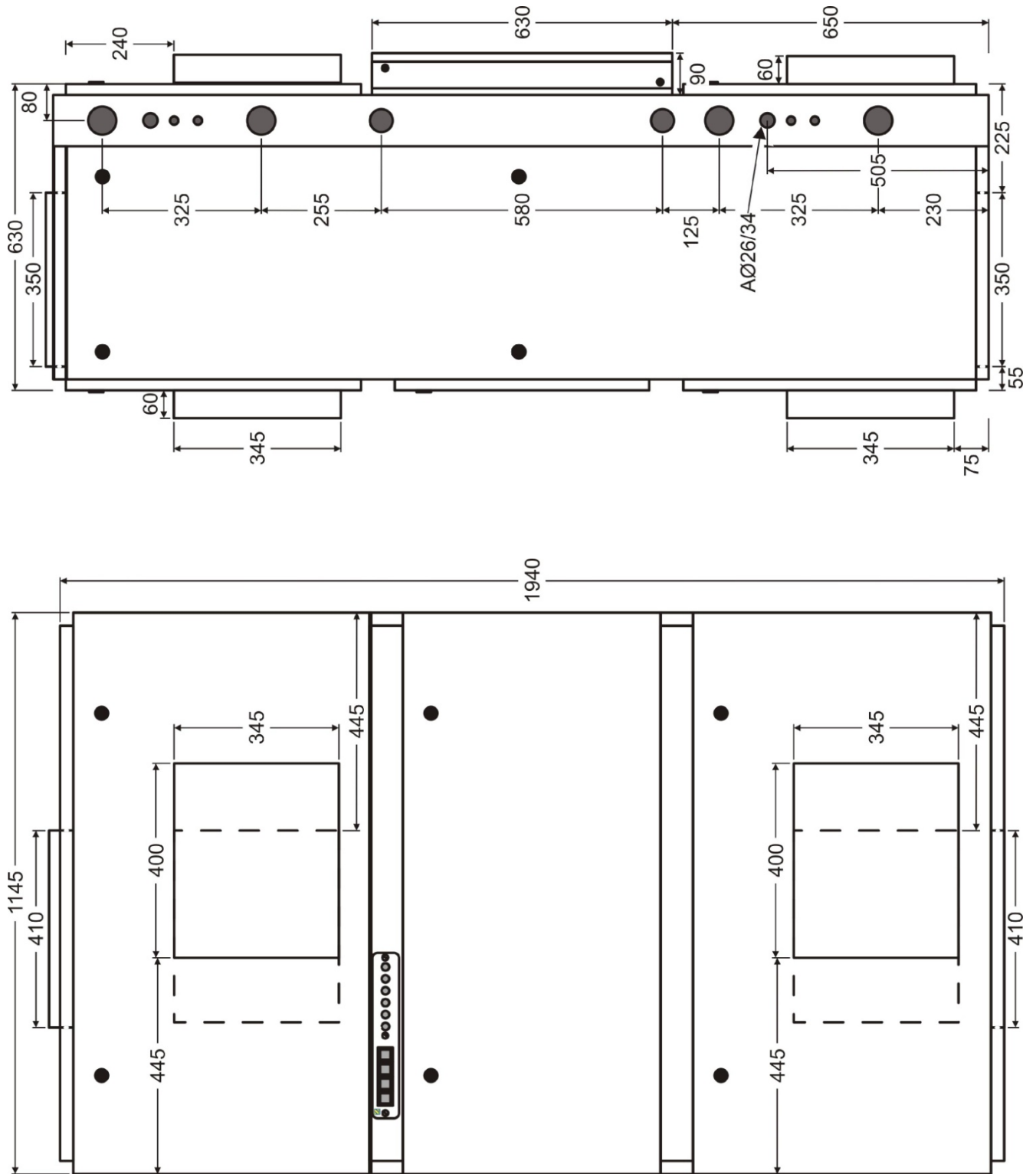

Oméga 28

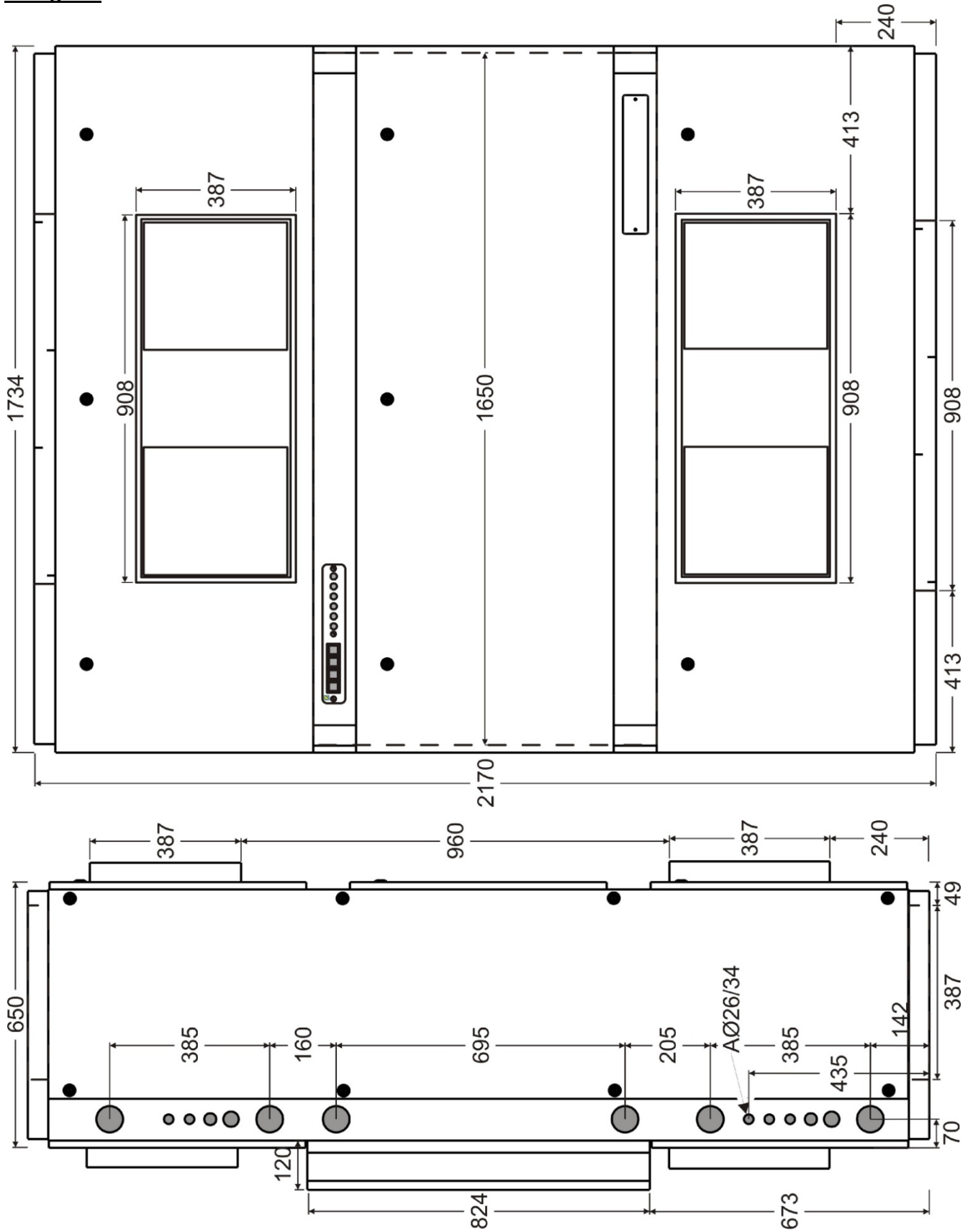

www.zodiac-poolcare.com

Pour plus de renseignements, merci de contacter votre revendeur.
For further information, please contact your retailer.

Votre revendeur / your retailer