

CE INSTRUCTIONS



INSTALLATION / OPERATION / CARE / MAINTENANCE / SAFETY ADVICE

REMOTE CONTROLS FOR AUTOMATIC SAFETY COVER

MOBILE APPLICATION



Manufactured in compliance
with the NF P 90-308 standard

WIRELESS WALL-MOUNTED REMOTE CONTROL



KEYRING REMOTE CONTROL



Not compliant with
NF P 90-308

FLUIDRA

Please read carefully and keep for future use

FLUIDRA INDUSTRY FRANCE

105 Rue Henry Potez
66000 Perpignan - FRANCE
Tel : 04.68.61.75.30

Series number

Revision index: C-01-2022

ABOVE GROUND ROLLER

Presentation	p.4
Positions of the various components.....	p.5
Wiring N-Carlit / Bahia / Zen'it	p.6
Wiring Sveltéa / Ulmo.....	p.7
Wiring Octéo	p.8
Wiring Octéo large dimensions.....	p.9

SUBMERGED ROLLER

Presentation	p.10
Positions of the various components	p.12
Wiring in receiver & UNICUM junction box	p.13
Wiring in receiver & GENKER junction box	p.14
Wiring in receiver & 'Fil d'eau' junction box	p.15

WALL-MOUNTED REMOTE CONTROL

Fitting the remote control	p.16
Pairing.....	p.16
Operation.....	p.17
Change mode	p.18
Change lock code	p.19
Battery level	p.19
Changing the battery	p.19

MOBILE APPLICATION

Download / compatibility / safety	p.20
Pairing.....	p.21
Operation.....	p.21
Wall-mounted remote control's battery.....	p.22
Password recovery	p.22
Contextual menu.....	p.22
Compliance with standard NF P90-308.....	p.23

KEYRING REMOTE CONTROL	p.24
-------------------------------------	-----------------------------

- The wall-mounted remote control and the Cover Connect application are control devices for operating an automatic pool cover to prevent unsafe access to the pool.



SWIMMING POOL SAFETY STANDARD (NF P 90-308)

- The wall-mounted remote control must be fitted at a fixed location near the pool.
- When using the wall-mounted remote control or the Cover Connect mobile application, the user must have an unobstructed view of the pool to make sure no one is in the pool during operation.
- The device must be used only by a responsible adult. The user must lock and keep the control devices paired with the cover out of reach of children. When the pool cover is open, the physical presence of a responsible adult is essential.
- The control device, wall-mounted remote control or Cover Connect mobile application must be in constant contact with each other when the cover is being closed.
- If the cover or the application is not working or is temporarily unavailable and the pool cannot be covered to prevent unsafe access, take the necessary measures to prevent access to the pool by bathers, especially children, until the system returns to normal operation.
- Caution: The pool is safe only when the cover is closed, locked and correctly installed according to the manufacturer's instructions. The cover must be closed systematically in case of absence from home, including momentary absences. The cover must always be completely open or completely closed and must never be left half-open or half-closed.

ELECTRICAL INSTALLATION STANDARD (NF C15-100)

- The wall-mounted remote control receiver must be connected by a qualified electrician according to the NF C 15-100 standard.
- Caution: Before touching the wires, disconnect the 230V power supply from the box.

END OF SERVICE LIFE

- Do not throw the product in the rubbish or in municipal recycling bins.
- Options:
 - Take the used unit to a waste disposal site
 - Give the device to a social purpose enterprise.
 - Return the used unit to the distributor when purchasing a new one. 



APP + WALL-MOUNTED REMOTE CONTROL

Up to two wall-mounted remote controls can be paired to a receiver



In compliance with standard NF P 90-308:
The distance between a mobile device and the wall-mounted remote control is restricted.
Therefore, placing the remote control in the right place is critical to making optimum use of the app, in addition to complying with this safety standard.

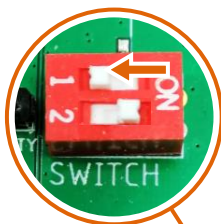

Bluetooth

Radio frequency

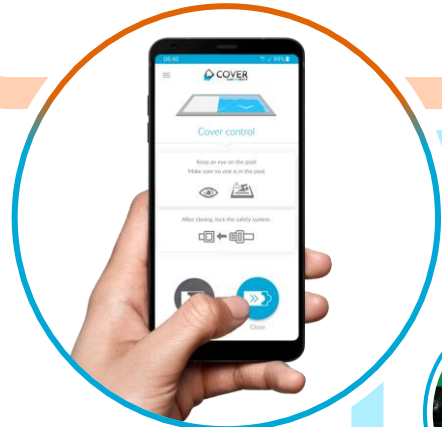

Bluetooth

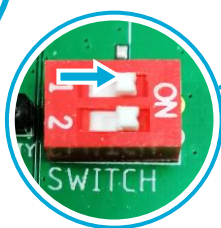
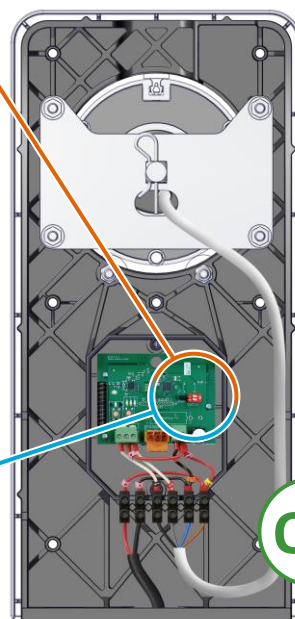

Radio frequency



Radio receiver/Bluetooth built in to the stand.
 Models :
 Sveltéa / Ulmo

OR

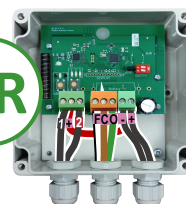

Models :
 • N-Carlit
 • Bahia
 • Zen'it

APP ONLY



An unlimited number of mobile devices can be paired to a receiver

Range may vary depending on the surroundings and the smartphone or tablet used.

In compliance with standard NF P 90-308:
If only the app is used, the distance between a mobile device and the cover's stand is restricted.

Radio frequency: frequency 434MHz (deviation = 4KHz) - Max transmitted power = 10dBm
 Bluetooth: min frequency 2.4GHz - max frequency: 2.482GHz - Max transmitted power = 0dBm



Octéo large dimensions
Octéo

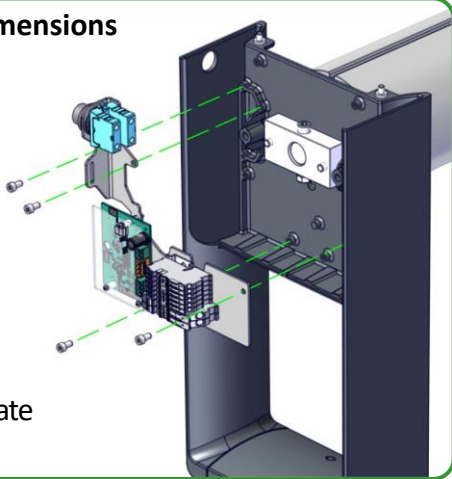

Replace the plate

Sveltéa
Ulmo

Attach the receiver card and the protective cover using the screws supplied.

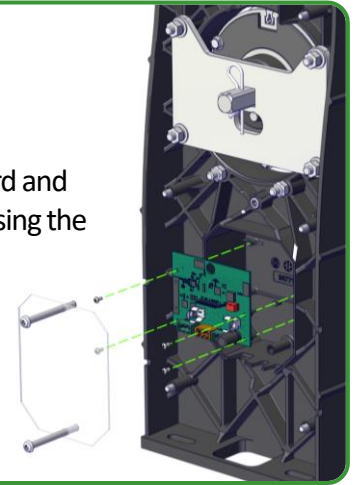

Attach the receiver in the stand using the self-adhesive tape supplied

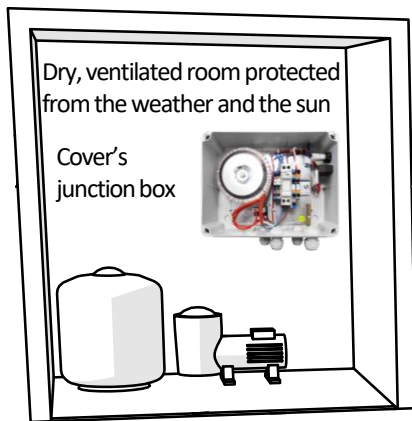
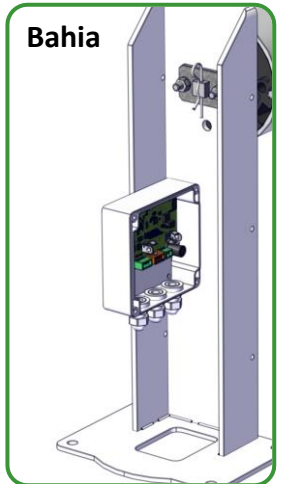
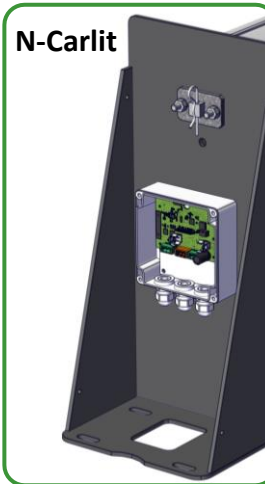
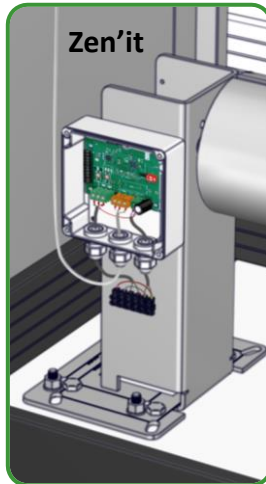

Install the remote control in a location protected from the weather and the sun



Radio frequency

Receiver

5m maximum
Unobstructed view of the pool

Turn the box's power off while handling the wiring

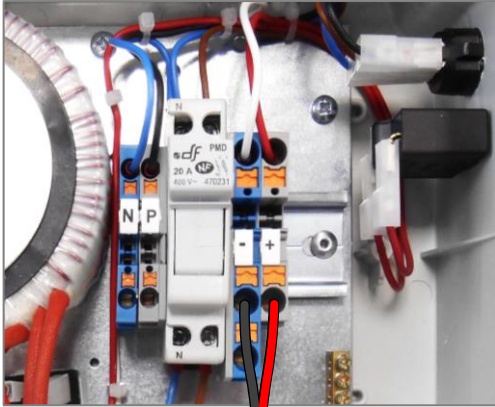

Cover's junction box

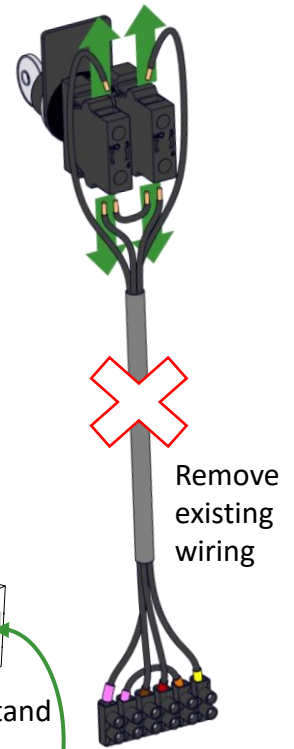

Remove existing wiring

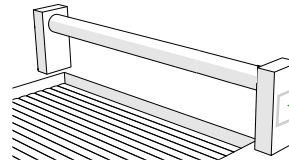

Receiver to be attached in the stand

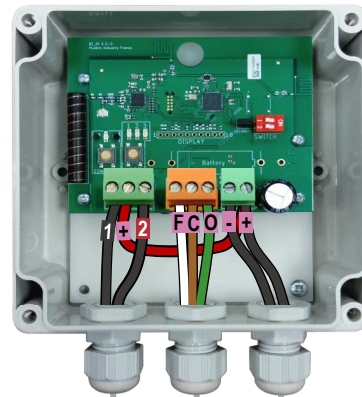
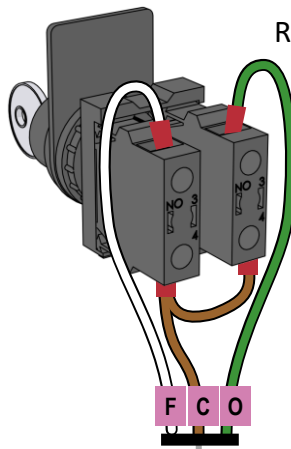

Supplied pre-wired



The receiver must be powered with a 24V DC power supply.

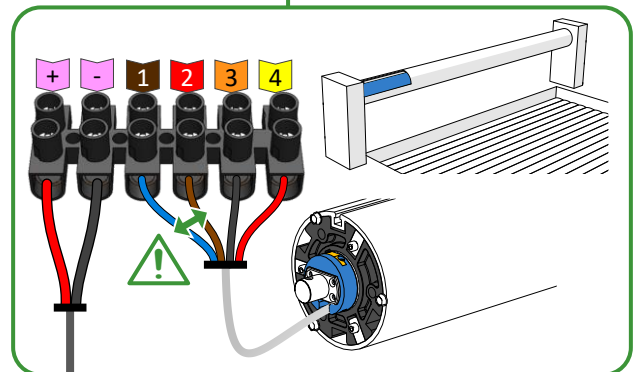
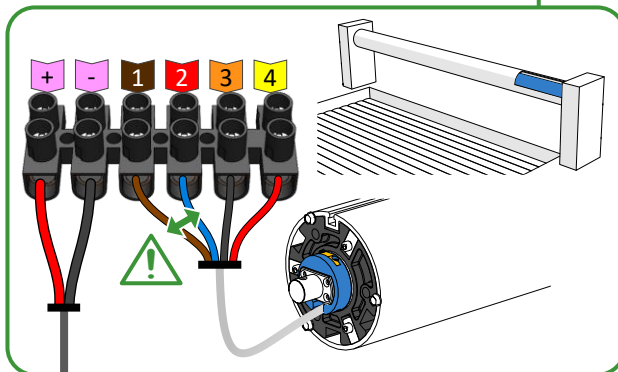

Refer to the roller installation manual to set the limit switches.

Turn the box's power off while handling the wiring

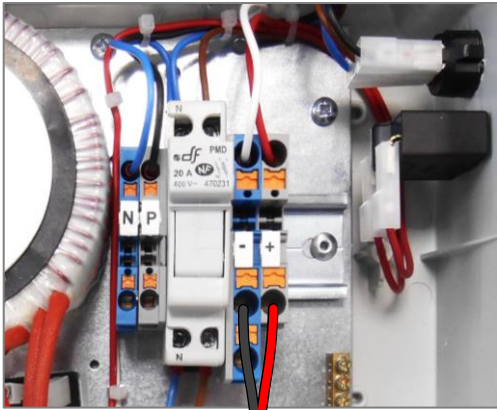

Cover's junction box

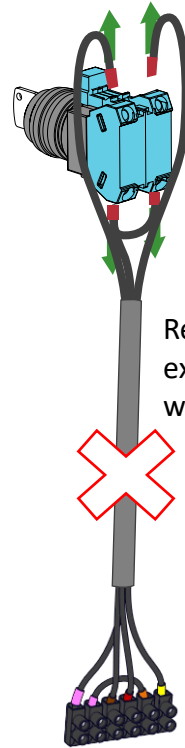

Remove existing wiring

The receiver must be powered with a 24V DC power supply.

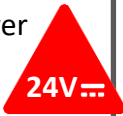

Receiver card to be attached in the stand

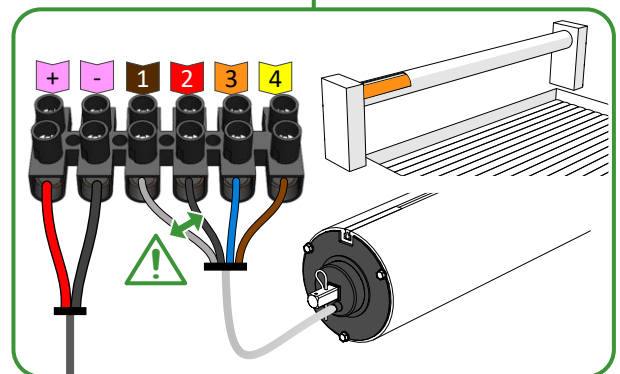
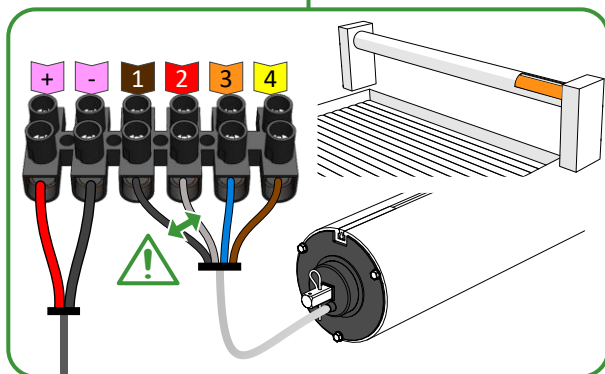
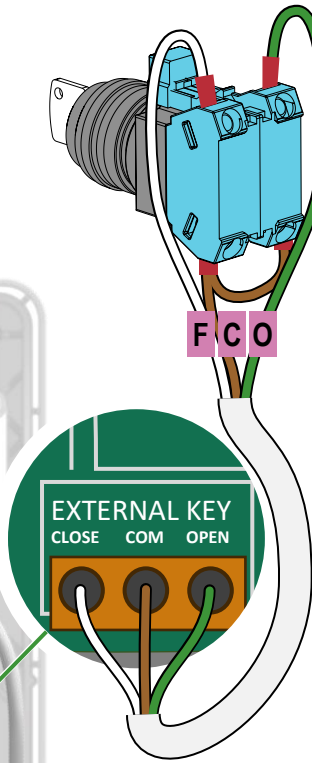
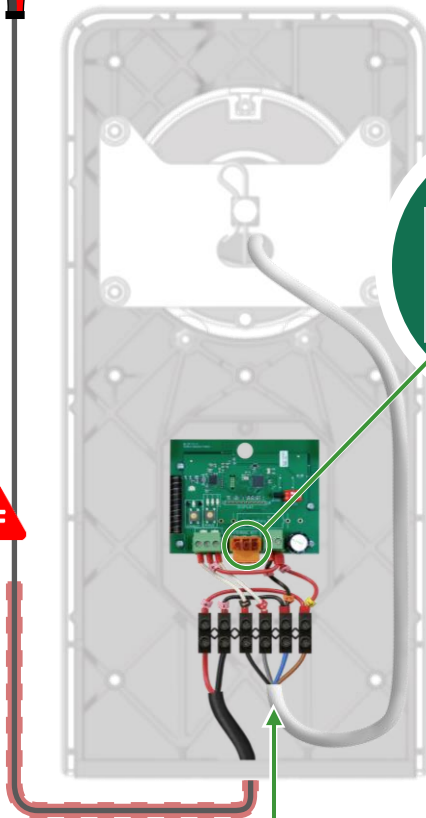

Refer to the roller installation manual to set the limit switches.

Turn the box's power off while handling the wiring

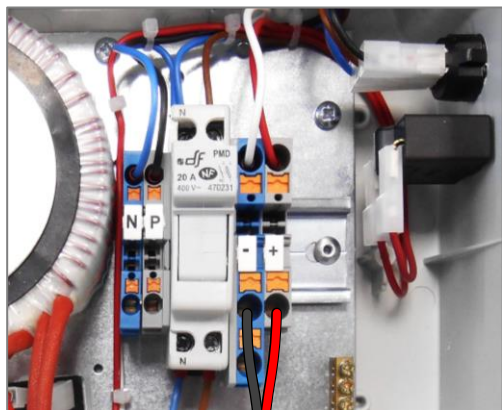

Cover's junction box

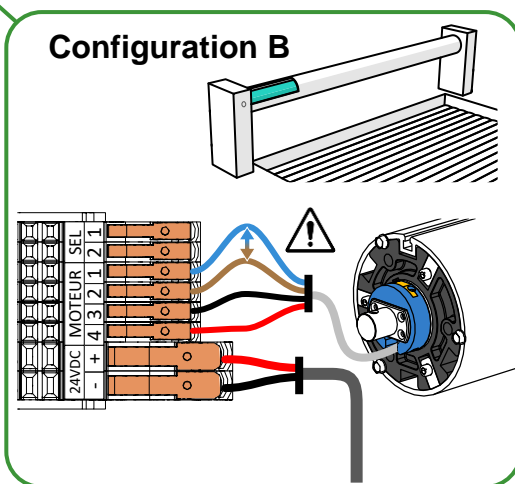
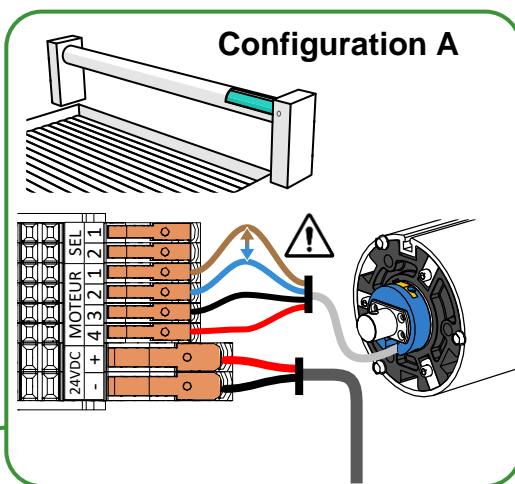

The receiver must be powered with a 24V DC power supply.



Do not allow the cable to go over the front of the receiver board.

Receiver card to be attached in the stand

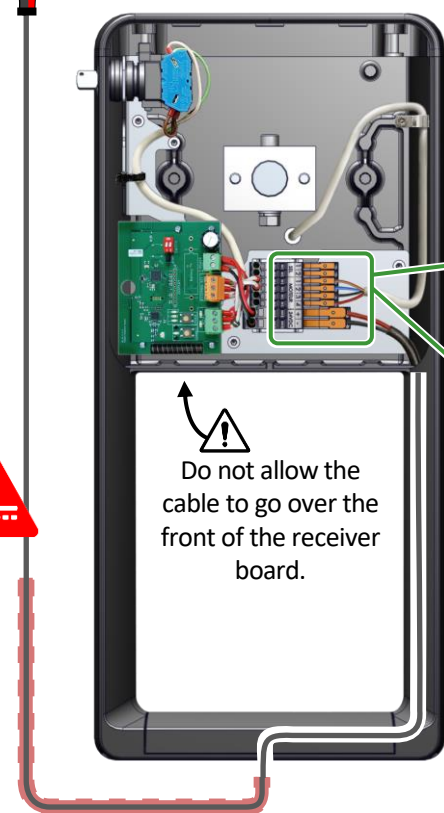

Refer to the roller installation manual to set the limit switches.

Turn the box's power off while handling the wiring

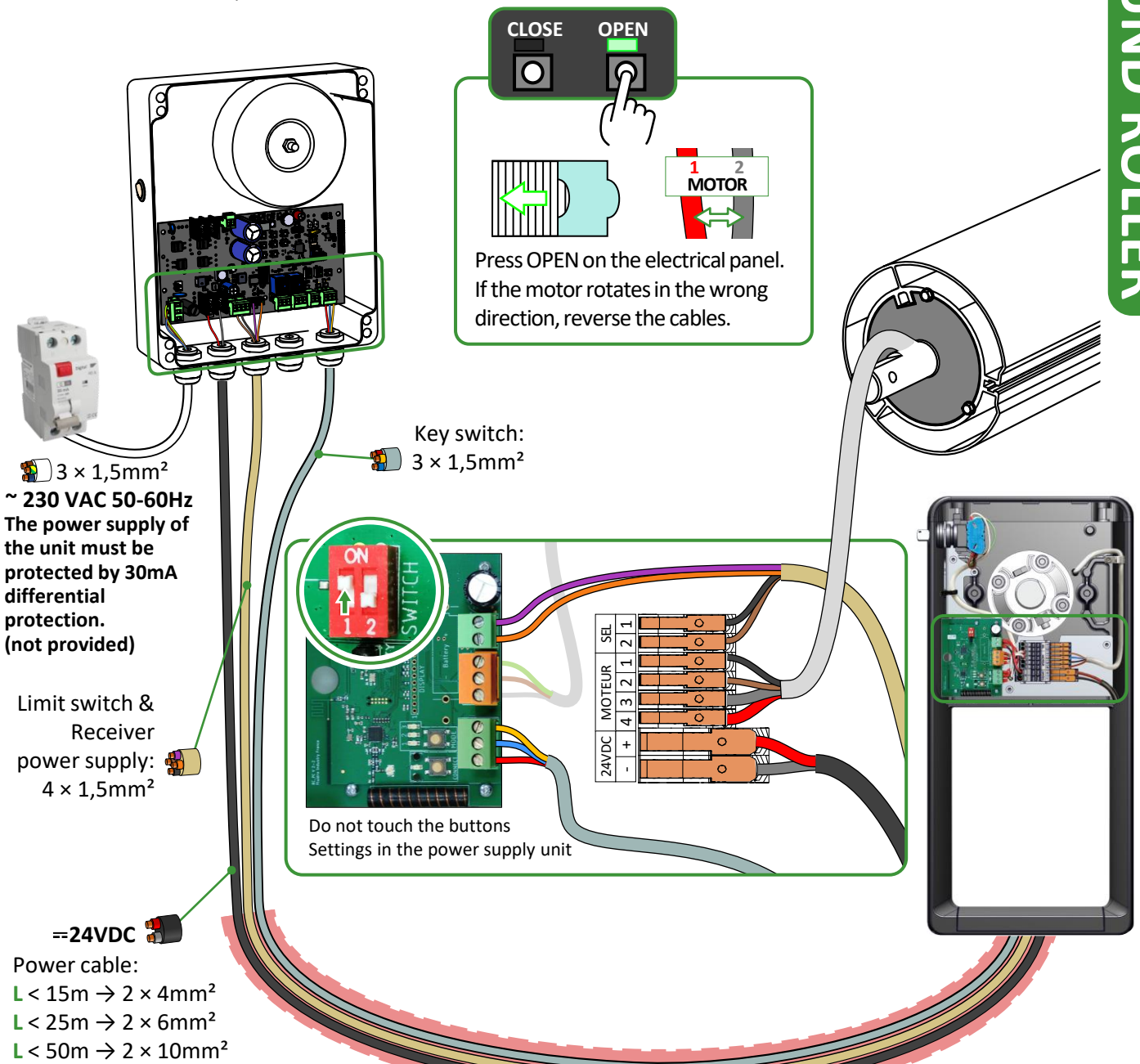
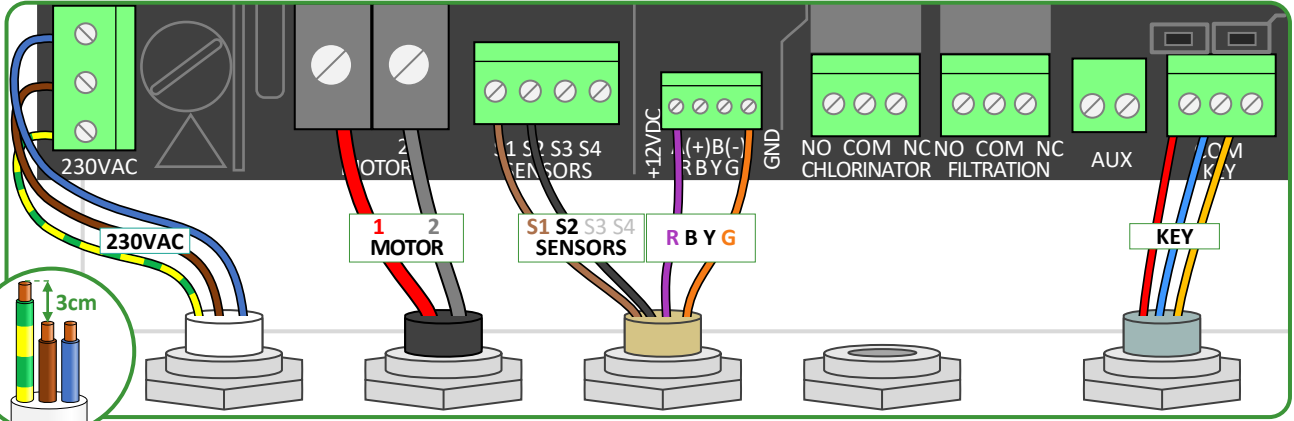

WALL-MOUNTED REMOTE CONTROL

In compliance with standard NF P 90-308:

The distance between a mobile device and the wall-mounted remote control is restricted. Therefore, placing the remote control in the right place is critical to making optimum use of the app, in addition to complying with this safety standard.

Up to two wall-mounted remote controls can be paired to a receiver

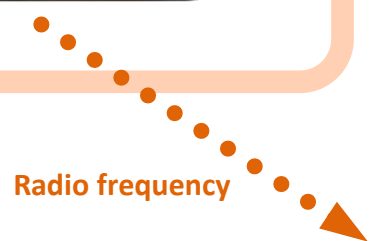

Range may vary depending on the surroundings and the smartphone or tablet used.

Bluetooth

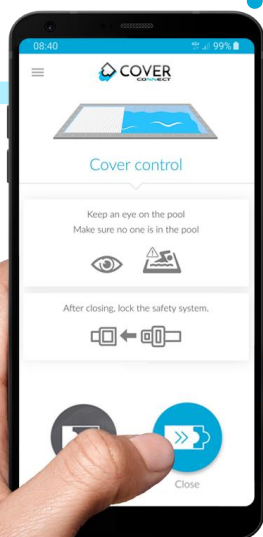

An unlimited number of mobile devices can be paired to a receiver

KEYRING REMOTE CONTROL

Up to two keychain remote controls can be paired to a receiver



Radio frequency

Box prior to 2021

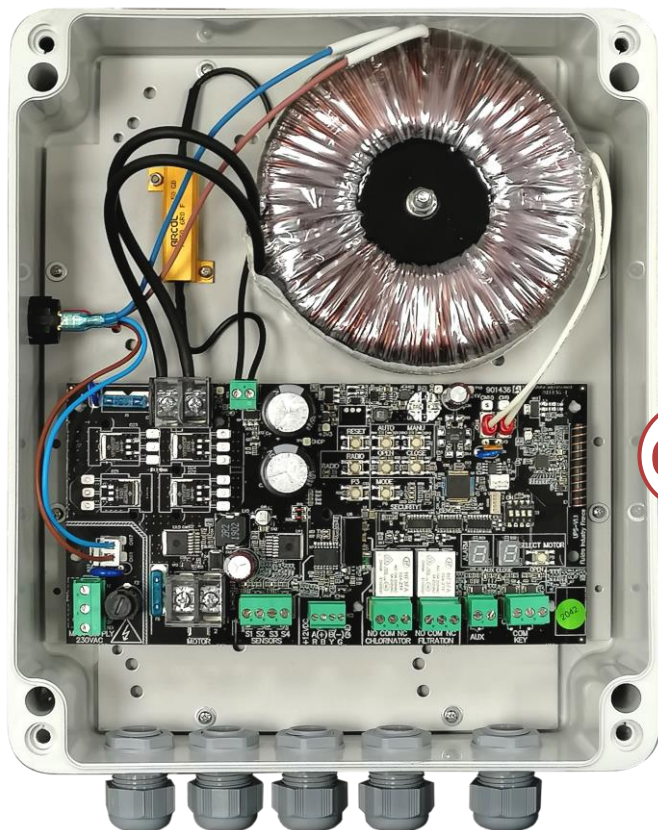

Radio receiver
Built in to the universal box.

OU

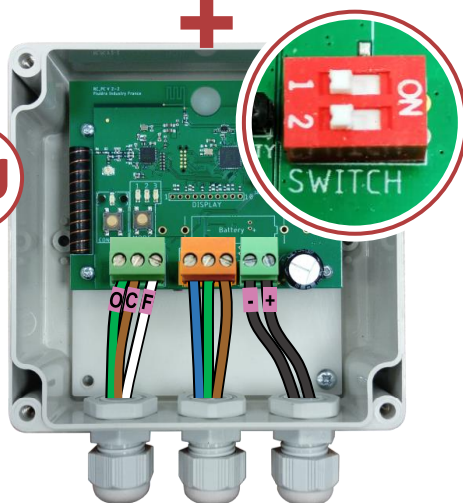

Radio receiver
To be wired in box for models
prior to 2021.

Radiofrequency: frequency 434MHz (deviation = 4KHz) - Max transmitted power = 10dBm
Bluetooth: min frequency 2.4GHZ - max frequency: 2.482GHZ - Max transmitted power = 0dBm

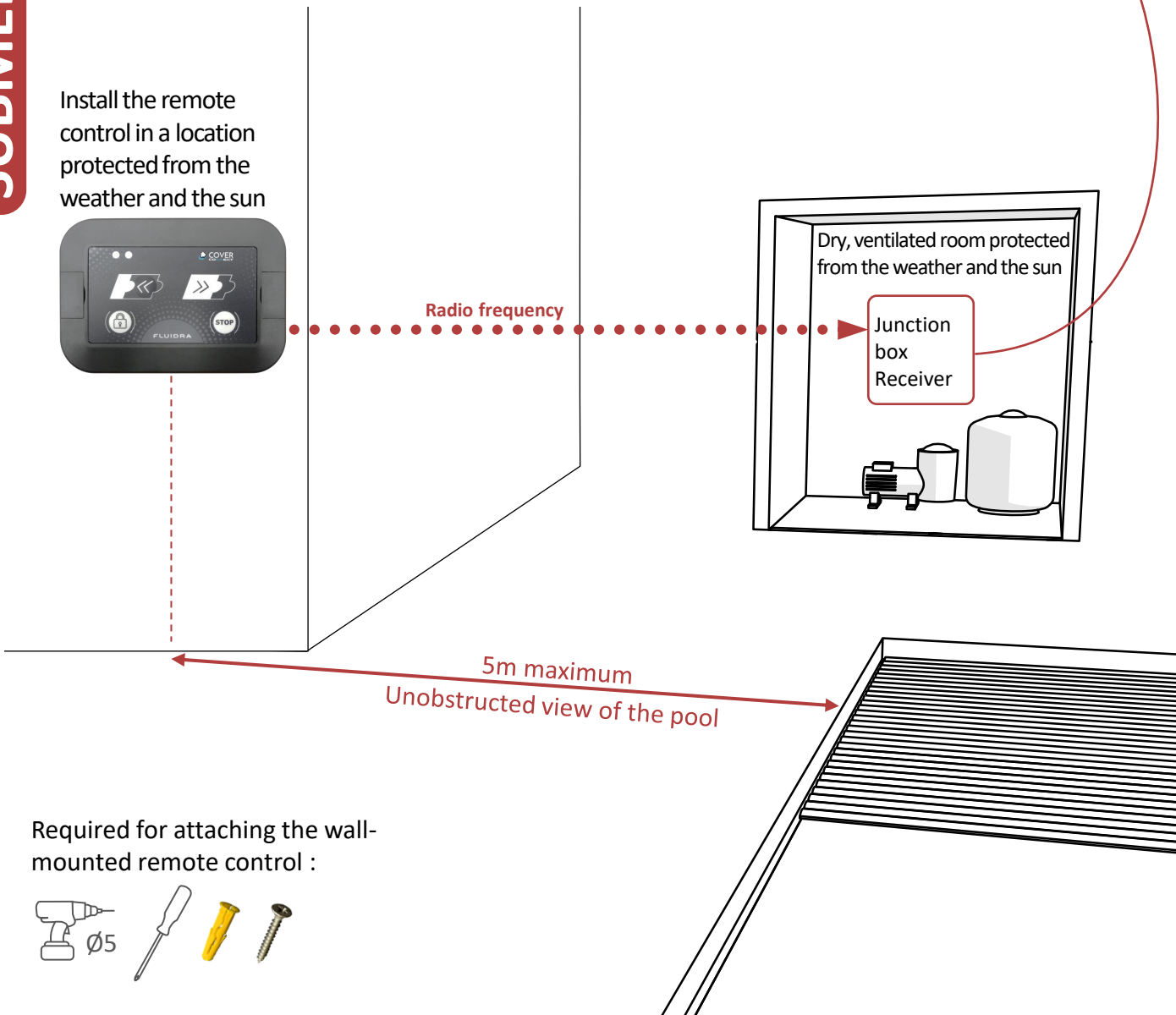
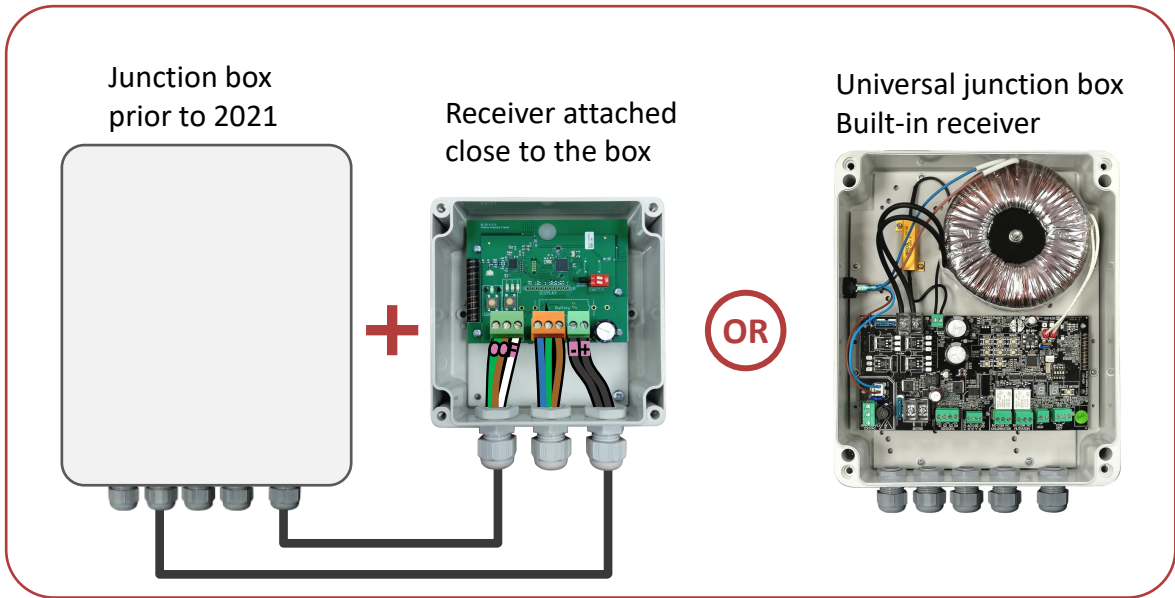

Required for attaching the wall-mounted remote control :



WIRING IN RECEIVER & UNICUM JUNCTION BOX

Axis motor + Dry pit motor (white)

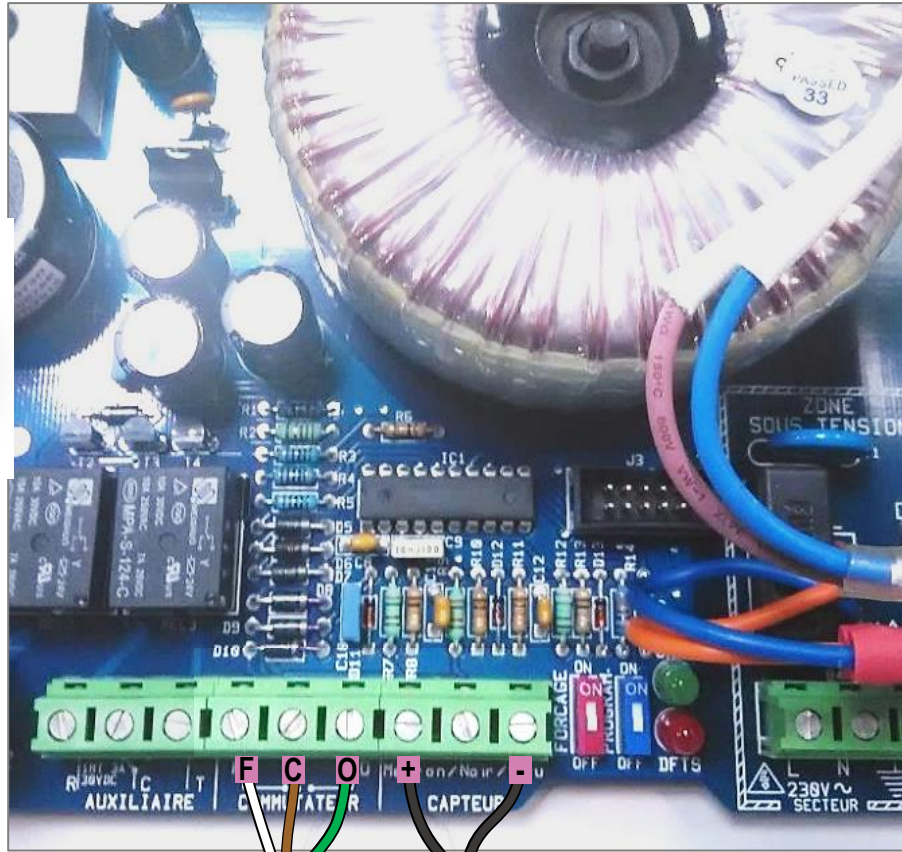
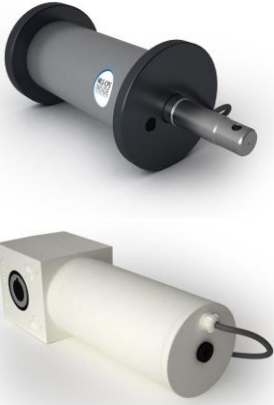

SUBMERGED ROLLER

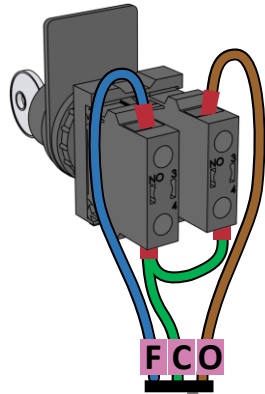

Optional wired key switch.
Do not connect directly to
the box.

Submerged pre-wired receiver

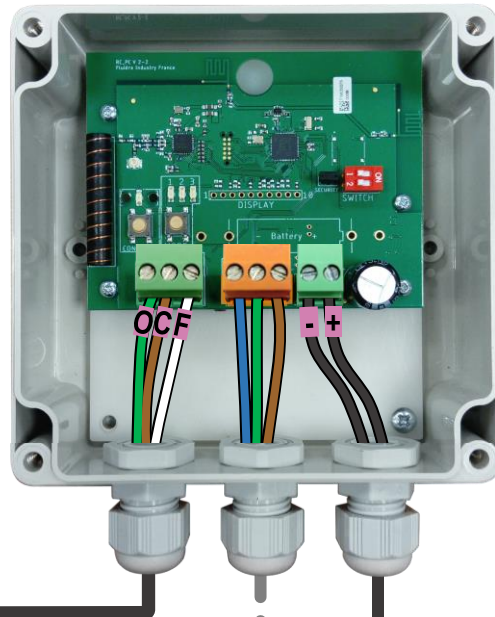

24V \equiv

The receiver must be
powered with a 24V DC
power supply.

Dry pit motor (blue)

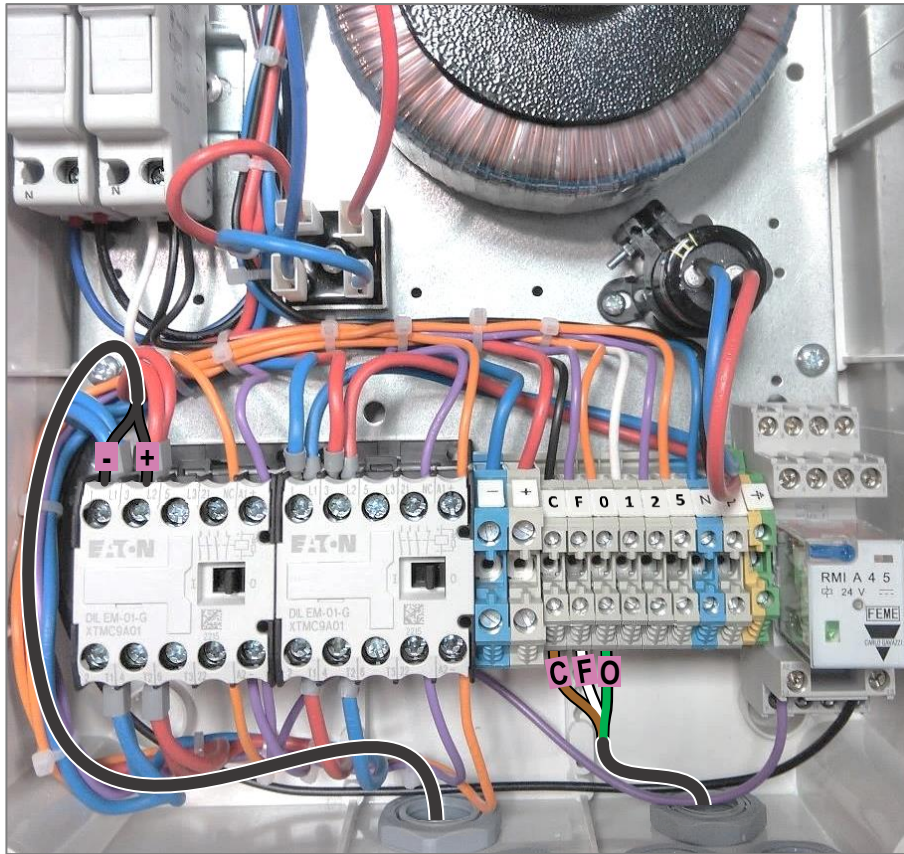

SUBMERGED ROLLER

Submerged pre-wired receiver

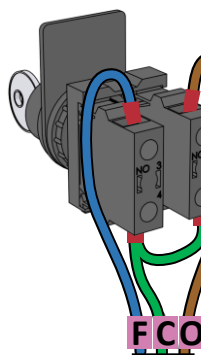

Optional wired key switch.
Do not connect directly to
the box.

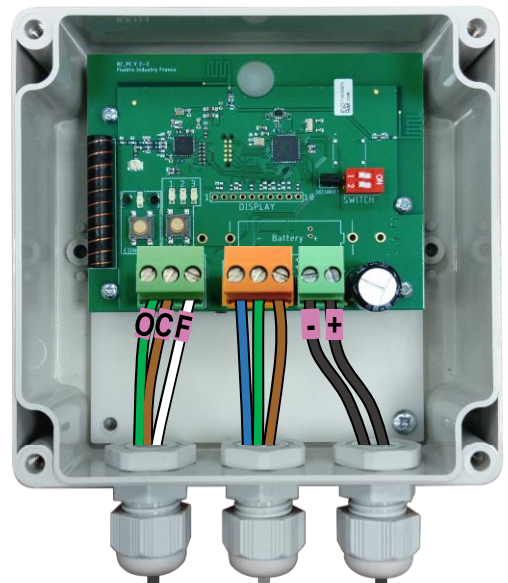

The receiver must be
powered with a 24V DC
power supply.



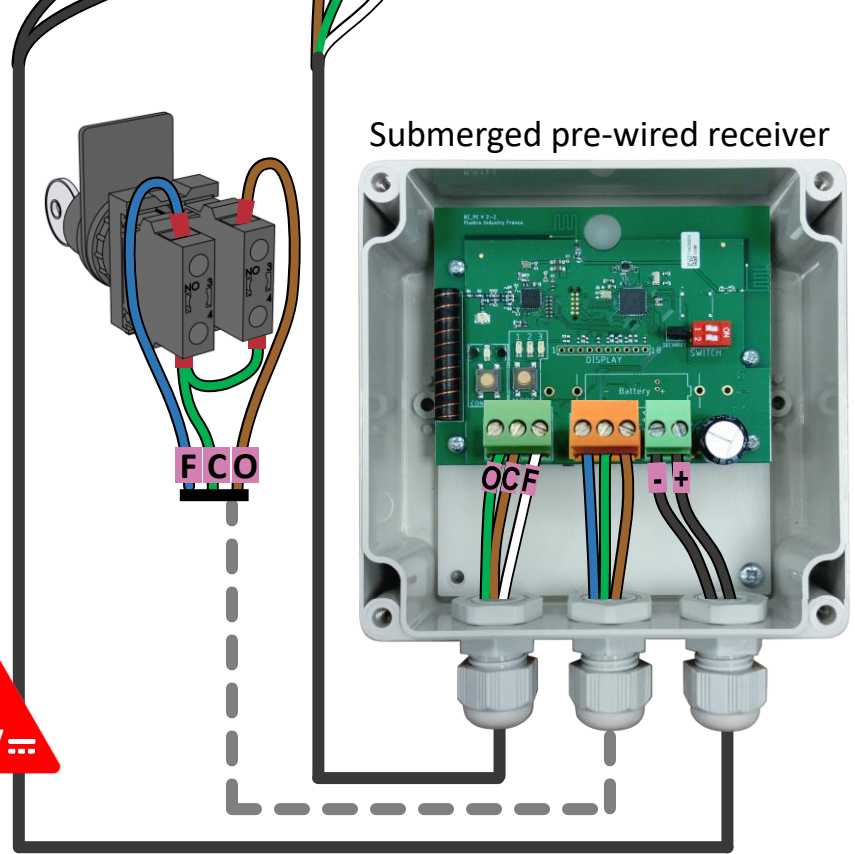
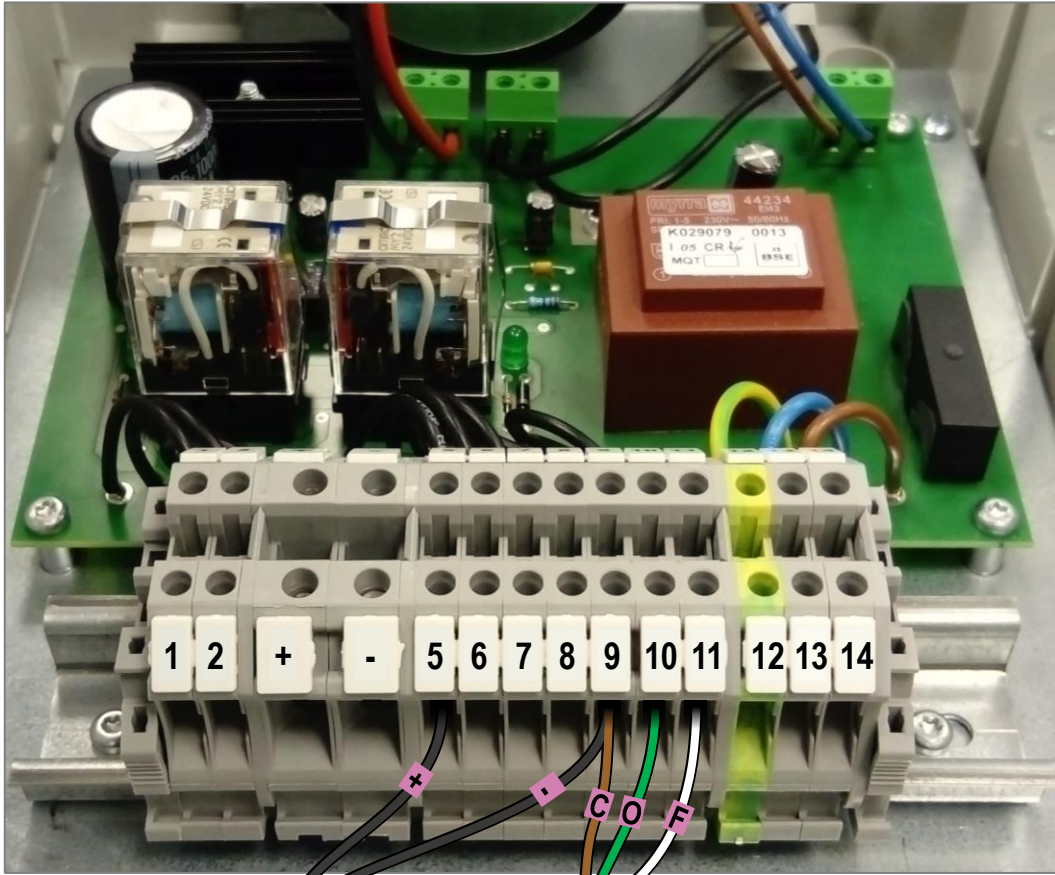

Optional wired key switch.
Do not connect directly to
the box.

The receiver must be
powered with a 24V DC
power supply. 

FITTING THE REMOTE CONTROL

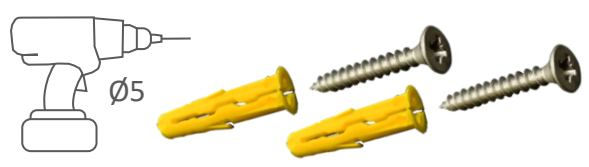

Install the remote control at a height lower than 2 m, with a direct view of the pool and less than 5 m away from it.



- External receiver box for submerged roller prior to 2021
- Receiver box or card in the stand of an above-ground roller

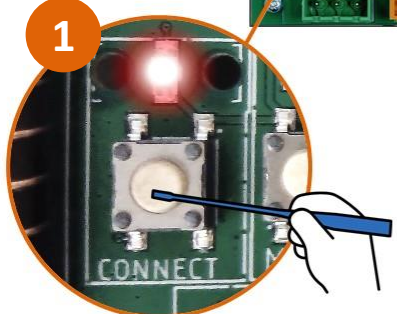
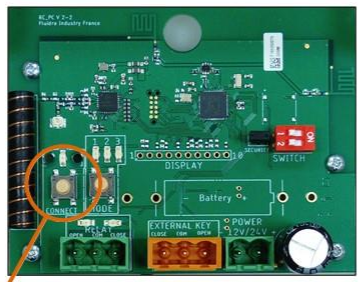

Long press on CONNECT until it flashes
Pairing in progress

PAIRING

- Universal box for submerged roller



Radio receiver
Built in to the universal box.



Long press on RADIO until it flashes
Pairing in progress



Unlock request



Default unlock code

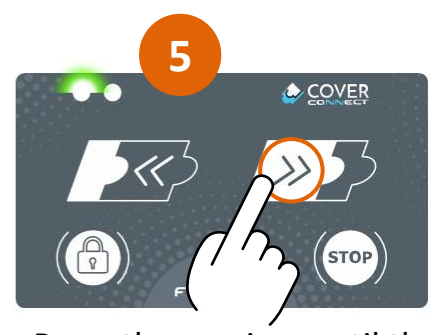

Press the receiver until the flashing stops
Pairing complete

OPERATION

UNLOCK

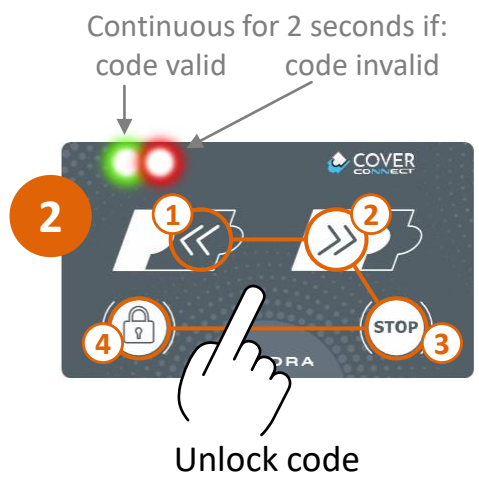
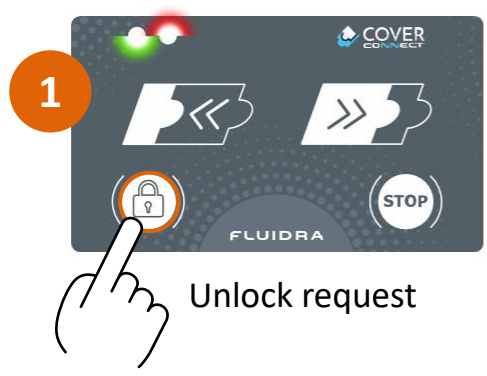

In case of error, wait 10 seconds or press 4 keys to return to step 1.

OPEN/CLOSE

After unlocking:

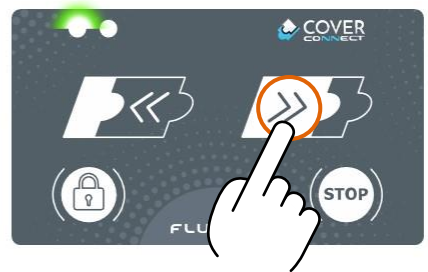

LOCK

Short press or automatic lock after 10 seconds of inactivity.
Long beep when locked.



Make sure the remote control is locked when you leave the pool area.

CHANGE MODE

- External receiver box for submerged roller prior to 2021
- Receiver box or card in the stand of an above-ground roller

Short press for 10 s to display the mode enabled

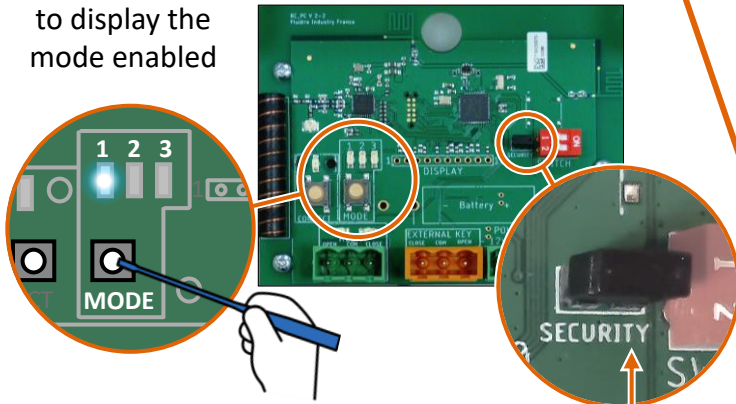

Press again to change the mode

• Universal box for submerged roller

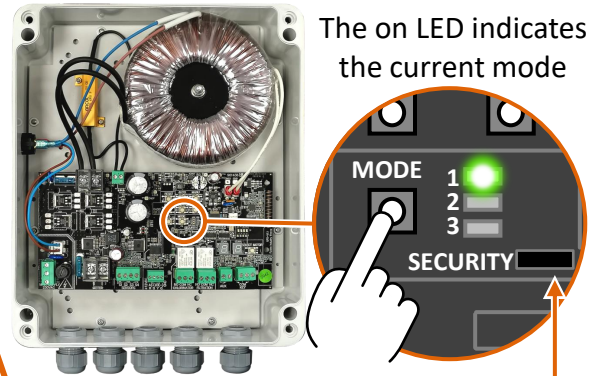

The on LED indicates the current mode

Short press: change mode

Remove the safety device to access mode 3

⚠ Mode not compliant with NF P 90-308

MODE 1: KEEP OPEN/CLOSED

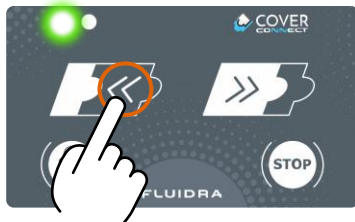

Press and **hold**: open cover

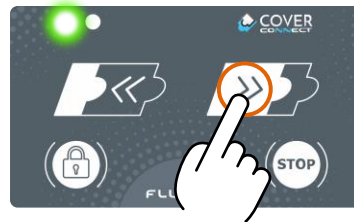

Press and **hold**: close cover

MODE 2: KEEP CLOSED

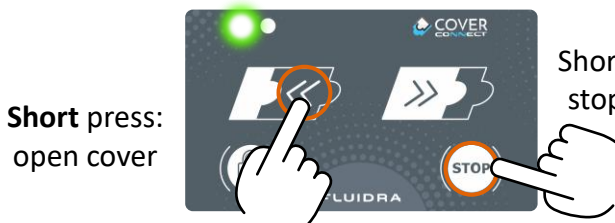

Short press: open cover

Short press: stop cover

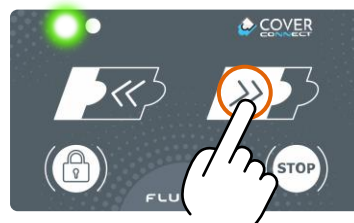

Press and **hold**: close cover

⚠ NOT COMPLIANT WITH NF P 90-308

MODE 3: IMPULSE

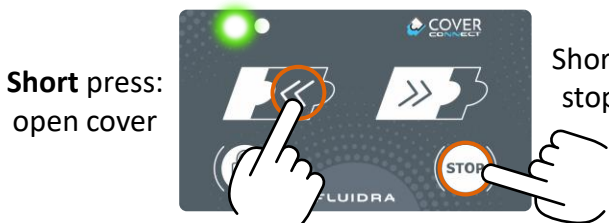

Short press: open cover

Short press: stop cover

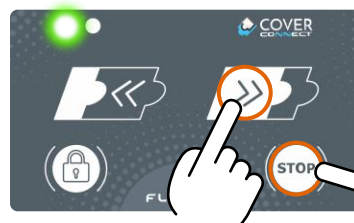

Short press: stop cover

Short press: close cover

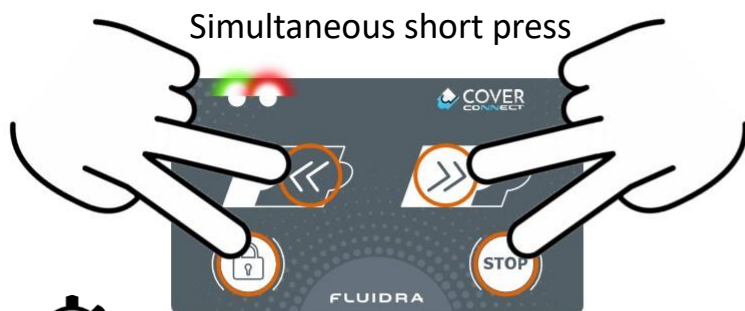

- 30 seconds to enter the new code.
- The code must be a combination of 4 keys.
- After 30 seconds, the LEDs stop flashing, the keypad locks and if no new code is entered, the old code is maintained.
- If you forget the code, you always have the option of creating a new one.

Continuous for 2 seconds if:
code valid code invalid



BATTERY LEVEL

Green LED flashing during opening/closing: Battery OK.



Red LED flashing during opening/closing: Battery level low, needs changing.

CHANGING THE BATTERY



• If the base is reconnected the wrong way round, a red LED will flash on the inside and outside of the remote control.

2 Be careful with the keypad base when opening the box and changing the battery.

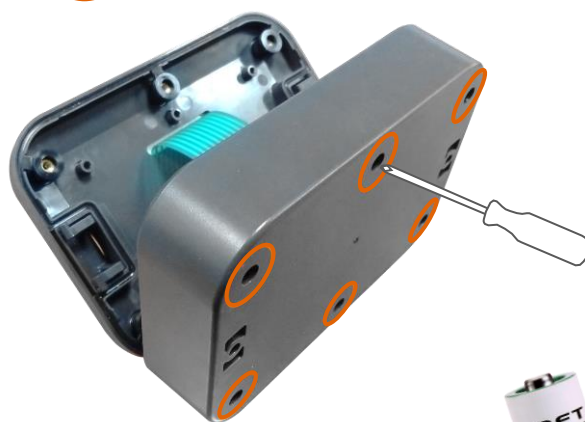

The remote control must be connected to a 3.6V DC power supply in the form of a SAFT-make lithium battery, model LS14500.

Fluidra code: 907676
Non-rechargeable.

Do not use a 1.5V alkaline battery.
In winter, remove the battery and store the wall-mounted remote control out of the cold.





- Cover Connect is an application for remote automatic cover operation using a mobile device (smartphone or tablet running on Android or iOS) with the latest updates.



- **Use the application from a position where you have a full and unobstructed view of the pool and make sure no one gets into the pool when the cover is being opened or closed. A distance limitation is applied between the terminal and the wall-mounted remote control.**
- **For best application performance, the mobile device must be pointing at the wall-mounted remote control while the cover is being opened or closed. Performance may vary depending on the mobile device used as each one has its own technical specifications and performance options.**
- The cost of all the software and hardware required to download and use the application, together with all other related costs, including telecommunications and subscriber costs, are exclusively on the user's account.
- If the cover is not working or if there is a power cut or similar and you cannot close the cover or make the pool safe, take the necessary measures to prevent anyone getting into the pool, especially children, until the system returns to normal operation.
- The user must also fit the cover with a wired key control system to operate the cover if the paired terminal is unavailable.
- FLUIDRA would like to point out that technology, the services available and applicable legislation are constantly changing. Therefore, the user is hereby informed that FLUIDRA may modify the content and features of the application and services in accordance with technical and/or legislative developments.
- The user hereby agrees to consult the App Store® and Google Play® platforms regularly to check the availability of new application updates and download them before continuing to use the services.
- FLUIDRA declines all liability for any direct or indirect, material or immaterial consequences arising from an incorrect consultation, use and/or interpretation of the information and/or advice contained in the application by the user or in cases of force majeure. Please refer to the general terms and conditions of use of the application.

- Enable Bluetooth on your mobile device, switch the app on and follow the instructions.
- Read and accept the general terms and conditions of use.
- Pairing:
 - Press the “start” or “stop” button on the wall-mounted remote control.
 - If you only have the app, turn the key of the switch on the winder’s stand.
 - Set a 4-digit password.

OPERATION

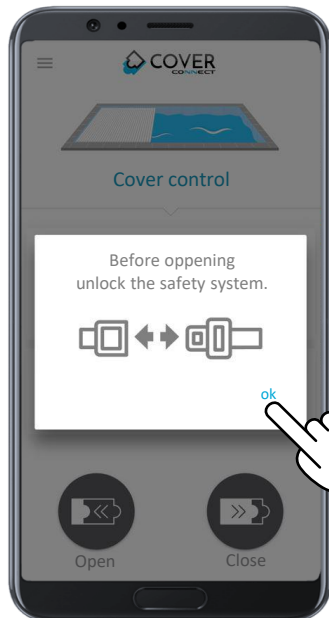
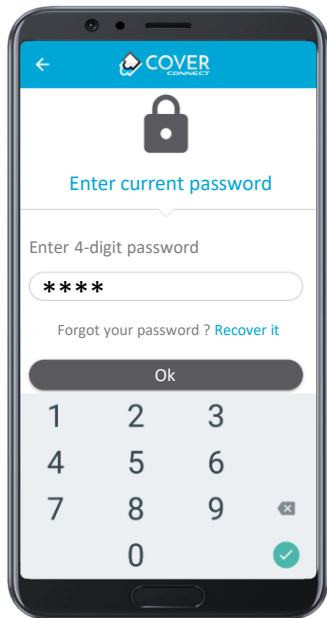

Unfasten the safety clamps. Press OK.

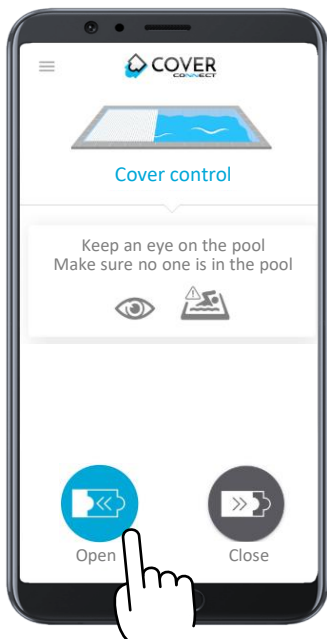

Press and hold: pool opens/closes

The application operating mode depends on the receiver mode (long/short press). ([see p.16](#)).

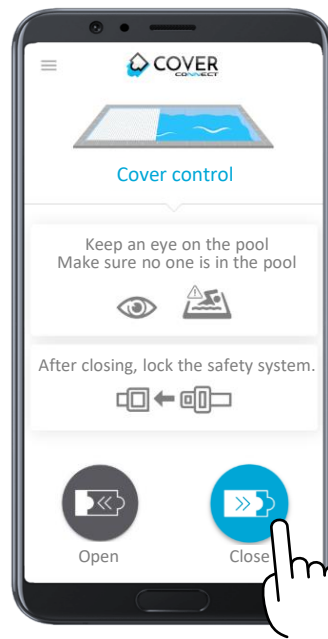

Switching the app off stops the impulse response function. (Receiver in mode 2 or 3).

Remember to lock the safety clamps in position once the cover has been closed.

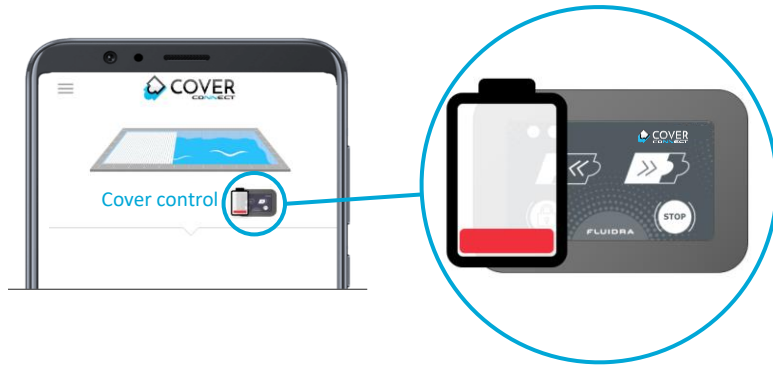

If this pictogram appears, change the battery in the remote control. (See p.17).

PASSWORD RECOVERY

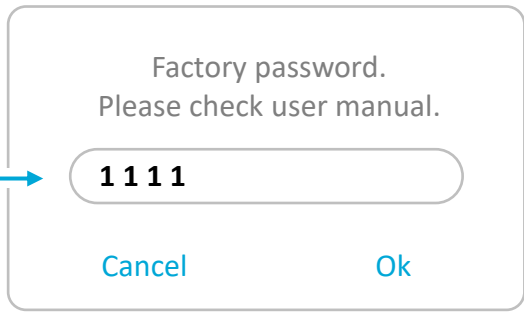
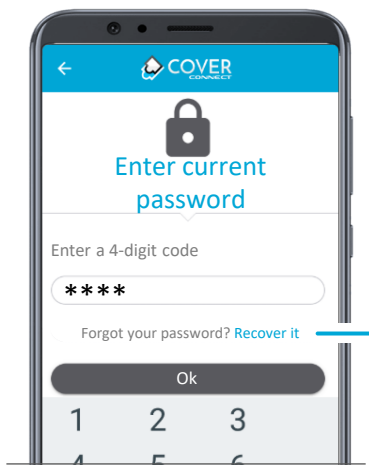

CONTEXTUAL MENU

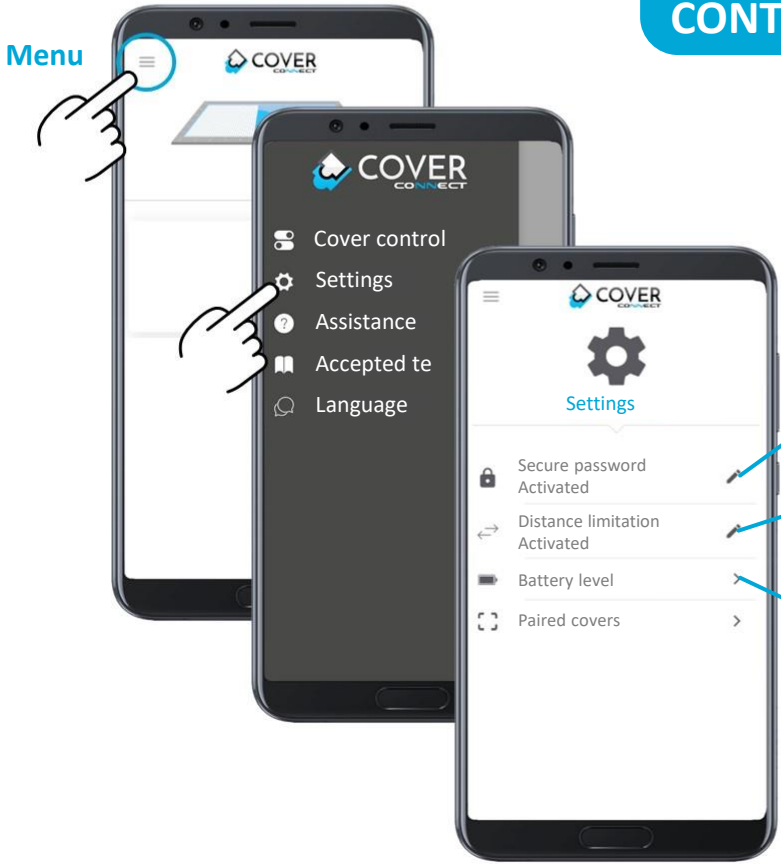

Enable/disable/change the password
Enable/disable restriction on distance
Set the wall-mounted remote control's battery level (optional)

COMPLIANT WITH THE NF P90-308 STANDARD IF:

- Security code enabled
- Distance limitation enabled

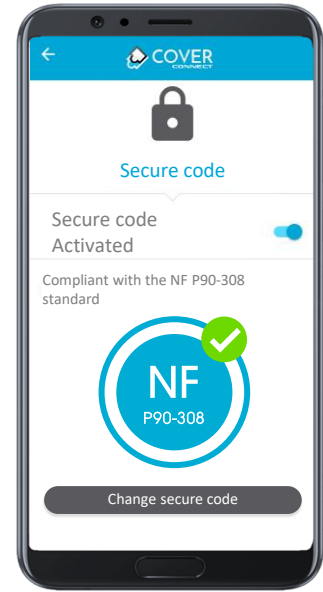
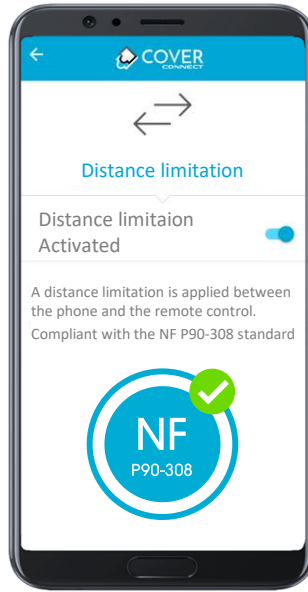

APP + WALL-MOUNTED REMOTE CONTROL

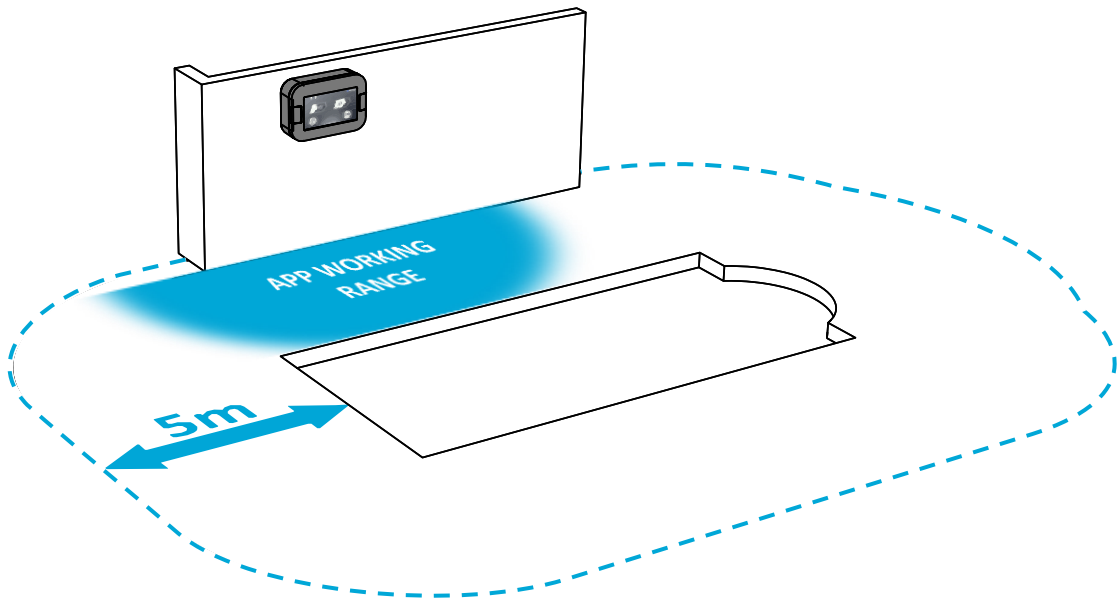

APP ONLY

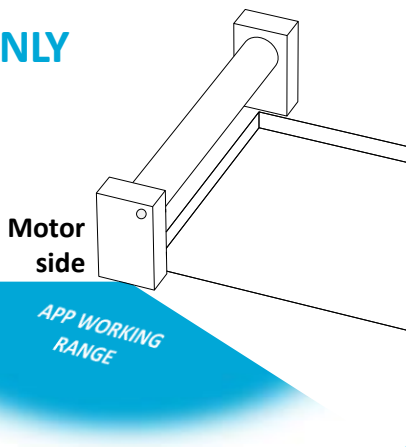

COMPLIANT WITH THE NF P90-308 STANDARD IF:

- The user has a full and unobstructed view of the pool all the time the cover is being opened or closed. (Range may vary depending on the surroundings and the smartphone or tablet used).
- The application operating area is entirely within the 5-metre limit around the pool.



- The keychain remote control enables the automatic cover to work at a distance.
- The range of the keychain remote control may vary depending on the environment.

- External receiver box for submerged roller prior to 2021
- Receiver box or card in the stand of an above-ground roller

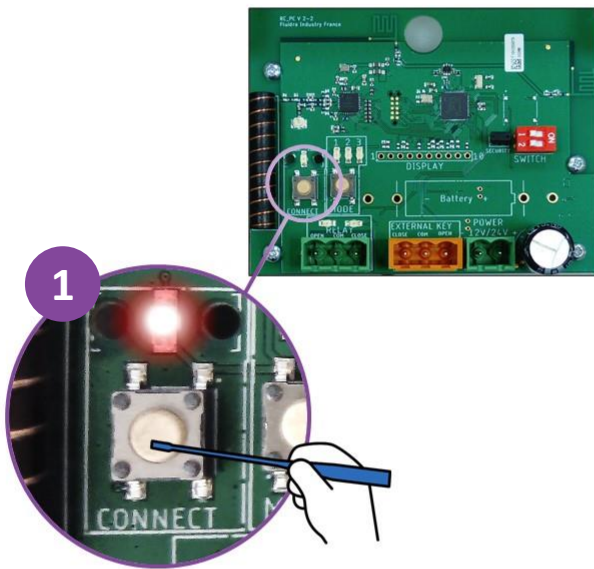

Long press on CONNECT
until it flashes
Pairing in progress

PAIRING

- Universal box for submerged roller



Radio receiver
Built in to the universal
box.

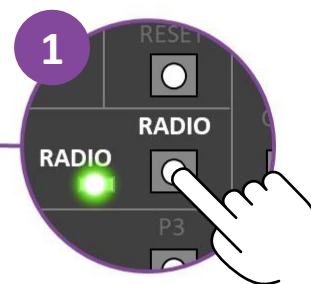

Long press on RADIO
until it flashes
Pairing in progress



Press the receiver until
the flashing stops
Pairing complete

CHANGING THE BATTERY



3V flat lithium battery
Reference CR 2032



OPERATION

- External receiver box for submerged roller prior to 2021
- Receiver box or card in the stand of an above-ground roller

Short press for 10 s to display the mode enabled

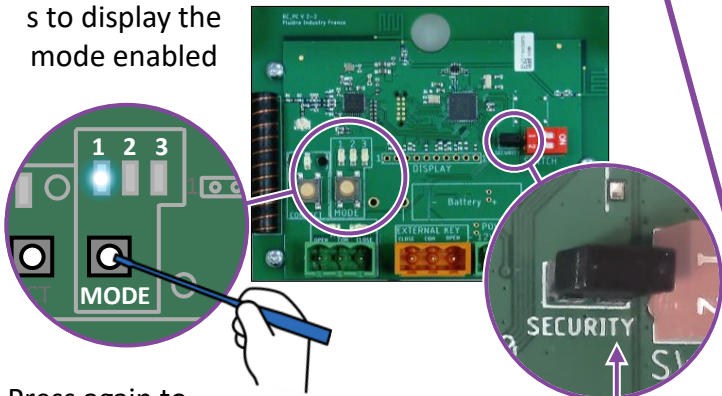

Press again to change the mode

- Universal box for submerged roller

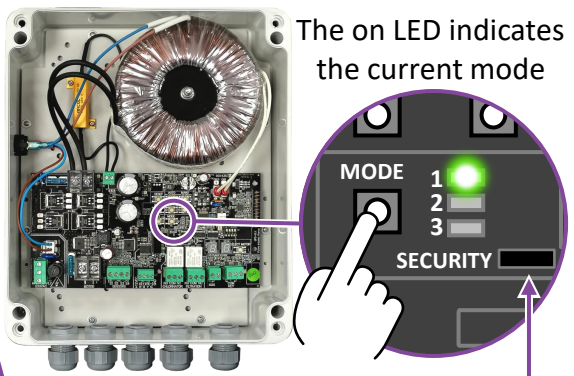

The on LED indicates the current mode

Short press: change mode

Remove the safety device to access mode 3

MODE 1: KEEP OPEN/CLOSED



Press and **hold**: open cover.



Press and **hold**: close cover

MODE 2: KEEP CLOSED

Short press: stop cover



Short press: open cover



Press and **hold**: close cover

MODE 3: IMPULSE

Short press: stop cover



Short press: open cover

Short press: stop cover

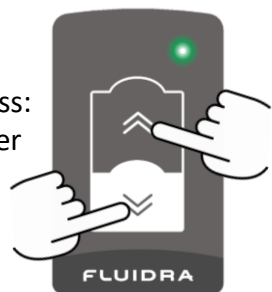

Short press: close cover.



SAFETY ADVICE

GENERAL SAFETY ADVICE

WARNING:

The pool may expose your children to significant risk. Drowning can occur very rapidly. Children near the pool require your constant vigilance and must be supervised at all times, even if they know how to swim.

Learn what you can do to save lives.

Memorise the first aid telephone numbers and post the information next to the pool.



FIRE SERVICE : ...

AMBULANCE : ...

Closest poison control center : ...

A responsible adult must be present at all times when the pool is open.



SAFETY ADVICE FOR USE OF COVERS

WARNING :

Note carefully that safety is only assured when the cover is closed, fastened, and has been correctly installed according to manufacturer's instructions.

- This cover is not a substitute for common sense or for individual responsibility. Its purpose is not to substitute the vigilance of parents and/or responsible adults, who remain essential for the protection of young children.
- The cover must always be closed when the owner is away from home, even if only for a moment.
- Opening and closing of the cover must only be carried out by a responsible adult.
- Check that there are no swimmers or foreign bodies in the pool before, during and after operation.
- Keep cover operation equipment well out of reach of children.
- Climbing, walking, or jumping onto the security cover is strictly forbidden.
- When a malfunction has been noted that prevents the closing of the cover and risks the safety of the pool, or if the equipment or the pool is temporarily unavailable, adopt all the necessary measures to prevent access to the pool until the cover has been repaired.
- Respect recommended water levels.

FLUIDRA

ORIGINAL INSTRUCTIONS. WE RESERVE THE RIGHT TO MODIFY ALL OR PART OF THE CHARACTERISTICS OF OUR ARTICLES OR THE CONTENT OF THIS DOCUMENT WITHOUT PRIOR WARNING.