

eXO® / eXO® iQ (LS) GenSalt OT

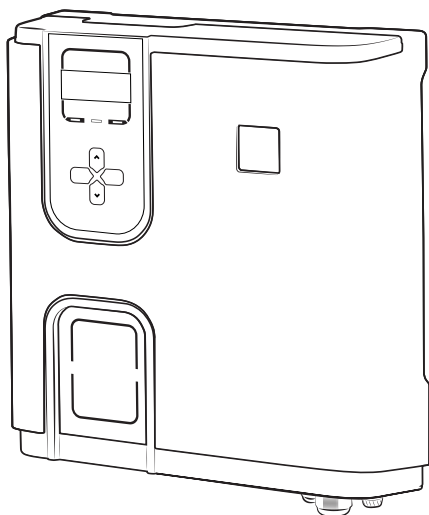

Instructions for installation and use - English
Salt water chlorinator, pH/Redox regulation
Translation of the original instructions in french

EN

pH Link / Dual Link

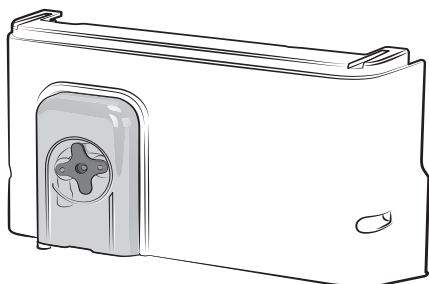

More documents on:
www.zodiac.com

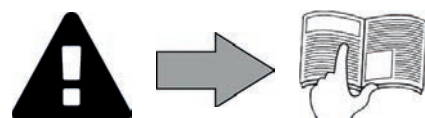

WARNINGS

GENERAL WARNINGS

- Failure to respect the warnings may cause serious damage to the pool equipment or cause serious injury, even death.
- Only a person qualified in the technical fields concerned (electricity, hydraulics or refrigeration) is authorised to perform this procedure. The qualified technician working on the appliance must use/wear personal protective equipment (such as safety goggles and protective gloves, etc.) in order to reduce the risk of injury occurring when working on the appliance.
- Before handling the machine, ensure that it is switched off and isolated.
- The appliance is intended to be used with pools for a specific purpose; it must not be used for any purpose other than that for which it was designed.
- It is important that the appliance is operated by people who are competent and qualified (both physically and mentally), after having read the instructions for use. All persons not meeting these criteria must not approach the appliance in order to avoid exposure to dangerous elements.
- This appliance is not intended for use by individuals (including children) with impaired physical, sensorial or mental abilities, or persons lacking in knowledge and experience, unless they receive supervision or prior instructions on using the appliance from a person responsible for their safety. Children must be supervised to ensure that they do not play with the appliance.
- This appliance must not be used by children under 8 or by adults whose reduced physical, sensory or mental capabilities, or whose lack of experience and knowledge, might cause a hazard, unless they have been correctly instructed to understand the safe use and hazards involved and are adequately supervised. Children must not be allowed to play with this appliance. User cleaning and maintenance operations must not be carried out by children without supervision.
- The appliance must be installed according to the manufacturer's instructions and in compliance with local standards in force. The installer is responsible for installing the appliance and for compliance with national installation regulations. Under no circumstances may the manufacturer be held liable in the event of failure to comply with applicable local installation standards.
- For any work other than the simple user maintenance described in this manual, the product should be referred to a qualified professional.
- Incorrect installation and/or use may cause serious damage to property or serious injuries (possibly causing death).
- All equipment, even postage and packing paid, travels at the risks and perils of the recipient. The latter shall issue reserves in writing on the carrier's delivery slip if damage is detected, caused during transport (confirmation to be sent to the carrier within 48 hours by registered letter). In the event that an appliance containing coolant has been turned on its side, mention your reservations in writing to the carrier.
- If the appliance suffers a malfunction, do not try to repair it yourself; instead contact a qualified technician.
- Refer to the warranty conditions for details of the permitted water balance values for operating the appliance.
- Deactivating, eliminating or by-passing any of the safety mechanisms integrated into the appliance shall automatically void the warranty, in addition to the use of spare parts manufactured by unauthorised third-party manufacturers.
- Do not spray insecticide or any other chemical (flammable or non-flammable) in the direction of the appliance, as this may damage the body and cause a fire.
- Do not touch the fan or moving parts and do not place a rod or your fingers in the vicinity of the moving parts during operation of the appliance. Moving parts can cause serious injury or even death.

WARNINGS ASSOCIATED WITH ELECTRICAL APPLIANCES







- The power supply to the appliance must be protected by a dedicated 30 mA residual current device, complying with the standards and regulations in force in the country in which it is installed.
- Do not use any extension lead when connecting the appliance; plug the appliance directly into a suitable wall socket.
- Before carrying out any operations, check that:
 - The voltage indicated on the appliance information plate corresponds to the mains voltage.
 - The power grid is adapted to the power requirements of the appliance, and is grounded.
 - The plug (where applicable) is suitable for the socket.
- In the event of abnormal operation or the release of odours from the appliance, turn it off immediately, unplug it from its power supply and contact a professional.
- Before any intervention on the appliance, ensure that the latter is switched off and disconnected from the power supply, in addition to any other equipment connected to the appliance.
- Do not disconnect and reconnect the appliance to the power supply when in operation.
- Do not pull on the power cord to disconnect it from the power supply.
- If the power cord is damaged, it must be replaced by the manufacturer, its technician or a qualified person to guarantee safety.
- Do not perform maintenance or servicing operations on the appliance with wet hands or if the appliance is wet.
- Clean the terminal block or the power supply socket before connection.
- For any component or sub-assembly containing a battery: do not recharge or dismantle the battery, or throw it into a fire. Do not expose it to high temperatures or direct sunlight.
- In stormy weather, unplug the appliance to prevent it from suffering lightning damage.
- Do not immerse the appliance in water (with the exception of cleaners) or mud.

Recycling



This symbol means that your appliance must not be thrown into a normal bin. It will be selectively collected for the purpose of reuse, recycling or transformation. If it contains any substances that may be harmful to the environment, these will be eliminated or neutralised. Contact your retailer for recycling information.

CONTENTS

	1 Specifications	5
1.1	Package contents	5
1.2	Technical specifications	7
	2 Installing the salt water chlorinator	8
2.1	Installing the cell	8
2.2	Installing the temperature sensor (depending on the model)	10
2.3	Installing the flow switch (chlorinator only without pH Link or Dual Link modules)	10
2.4	Installing the control box	11
2.5	Electrical connections	12
	3 Installing a pH Link or Dual Link module	19
3.1	Installing the module	19
3.2	Installing the POD kit	20
3.3	Installing the flow switch on the POD kit	23
3.4	Installing the sensors on the POD kit	24
3.5	Installing the pH minus injection and suction hoses	25
	4 Preparing the pool	27
4.1	Balancing the water	27
4.2	Adding salt	28
	5 Use	29
5.1	User interface	29
5.2	Configuration before use	29
5.3	Calibrating the sensors (if an optional "pH Link" or "Dual Link" module has been installed)	41
5.4	Routine use	46
	6 Control using the iAquaLink™ app (depending on the model)	48
6.1	Configuring the appliance before first use	48
	7 Care	50
7.1	Cleaning the sensors	50
7.2	Inspecting and cleaning the electrodes	51
7.3	Washing the pool filter (backwashing) (depending on the model)	52
7.4	Winterising	52
7.5	Preparing the pool for re-use	52



8 Troubleshooting

53

8.1 | Appliance behaviour

53

8.2 | Wi-Fi LED behaviour

55

8.3 | Effects of the stabilising agent on chlorine and ORP

56

8.4 | HELP menu

56

- Before handling the appliance, it is vital that you read this installation and user manual, as well as the "warnings and warranty" booklet delivered with the appliance. Failure to do so may result in material damage or serious or fatal injury and will void the warranty.
- Keep and pass on these documents for later consultation during the appliance's service life.
- The distribution or modification of this document in any way is prohibited, without prior authorisation from Zodiac®.
- Zodiac® is constantly developing its products to improve their quality. The information contained herein may therefore be modified without notice.



1 Specifications

EN

1.1 | Package contents

1.1.1 The appliance

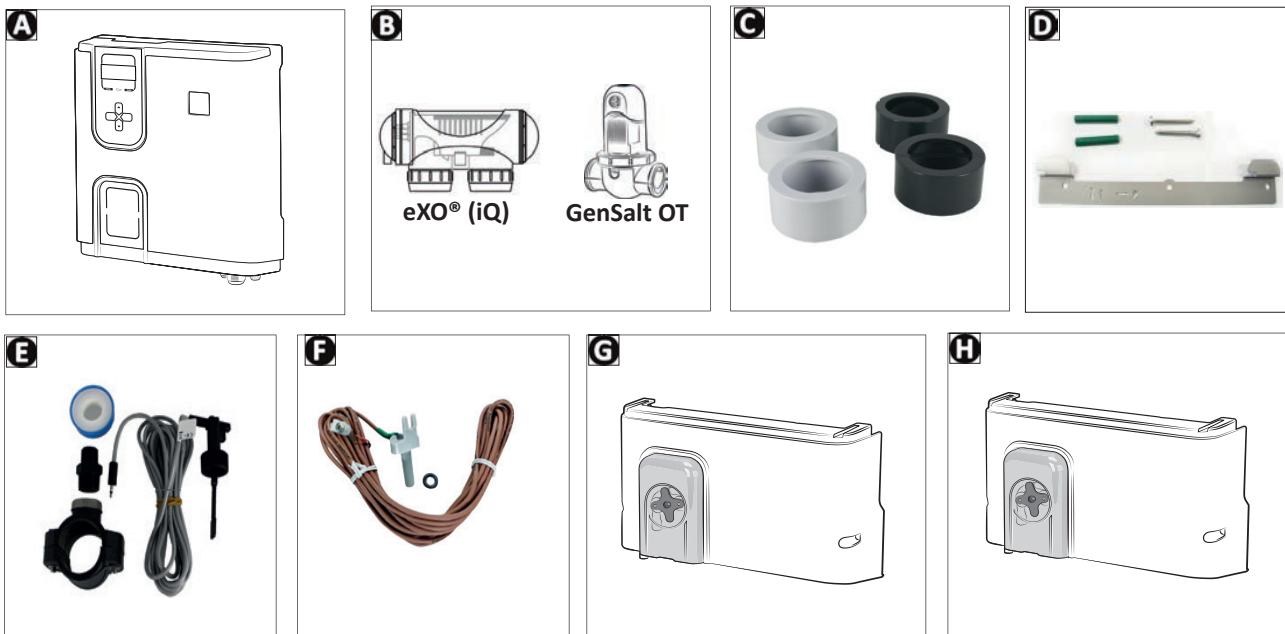

		eXO® (iQ)	GenSalt OT
A	Control box	✓	✓
B	Electrolytic cell	✓	✓
C	Glue-on adapter and union coupling kit for electrolytic cell	✓	
D	Wall-mounting bracket kit	✓	✓
E	Flow switch with installation kit	✓	✓
F	Temperature sensor with installation kit	✓	
G	pH Link module (pH measurement and automatic adjustment)	+	+
H	Dual Link module (pH and ORP measurement and automatic adjustment)	+	

✓: Included

+: Optional extra

1.1.2 Optional pH Link or Dual Link module



		pH Link	Dual Link
A	pH Link or Dual Link module	✓	✓
B	POD kit	✓	✓
C	Hole saw for installing the POD kit	✓	✓
D	Threaded sensor holder(s)	✓ x1	✓ x2
E	pH sensor + pH7 (x3) and pH 4 (x3) buffer solutions	✓	✓
F	ORP sensor + 470 mV ORP buffer solutions (x3)		✓
G	5-metre suction and injection hose	✓	✓
H	Bag of mounting fittings (2 threaded caps, 1 ceramic weight with support tip, Teflon tape)	✓	✓

✓: Included

1.2 I Technical specifications

1.2.1 Salt water chlorinator

	eXO® (iQ) 10 GenSalt OT 10	eXO® (iQ) 18 GenSalt OT 18	eXO® (iQ) 22	GenSalt OT 25	eXO® (iQ) 35
Nominal chlorine production	10 g/h	18 g/h	22 g/h	25 g/h	35 g/h
Nominal output current	2.8 A	3.6 A	5 A	5 A	7.2 A
Recommended salt level - minimum salt level	Standard salinity	eXO®(iQ): 4 g/L - 3.3 g/L min. GenSalt OT: 3.0 g/L min.			
	Low salinity (LS)	2 g/L - 1.6 g/L min.	/		
Supply voltage	110 - 240V 50-60 Hz				
Electrical power	200 W maximum				
Protection rating	IP43				
Cell throughput (minimum/ maximum)	5m ³ /h < 18m ³ /h				
Maximum allowable pressure in the cell	2.75 bar				
Operating water temperature	5°C < 40°C				
Frequency bands	2.400 GHz - 2.497 GHz				
Radio output power	+19.5 dBm				

EN

1.2.2 Optional pH Link or Dual Link module

	pH Link	Dual Link
Supply voltage	Extra-low voltage (connected to the control box)	
Peristaltic pump flow rate	1.2 L/h	
Maximum back pressure (injection)	1.5 bar	
pH and ORP sensor type	Combined (pH=blue/ORP=yellow)	
pH correction	pH minus only (hydrochloric acid or sulphuric acid)	
pH minus dispensing	Proportional cyclic	
pH sensor calibration	1 point or 2 points (pH 4 and pH 7)	
ORP sensor tolerances	/	10 ppm maximum (shock chlorination)
ORP sensor calibration	1 point (470 mV)	
Sensor cable length	3 metres	



2 Installing the salt water chlorinator

2.1 I Installing the cell

- The cell must be installed on the piping after the filtration system, after any measurement sensors, and after any heating system.

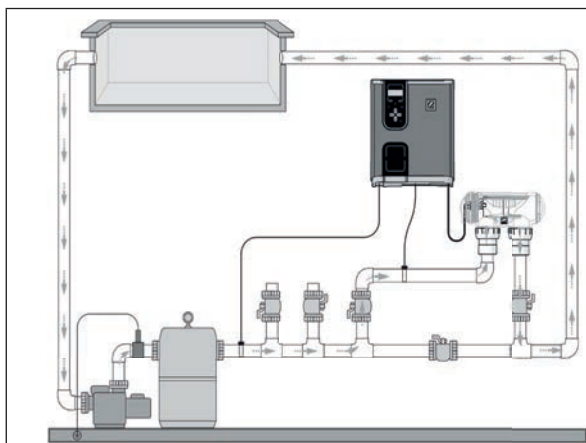

Installing the chlorinator only
(Example with eXO® (iQ))

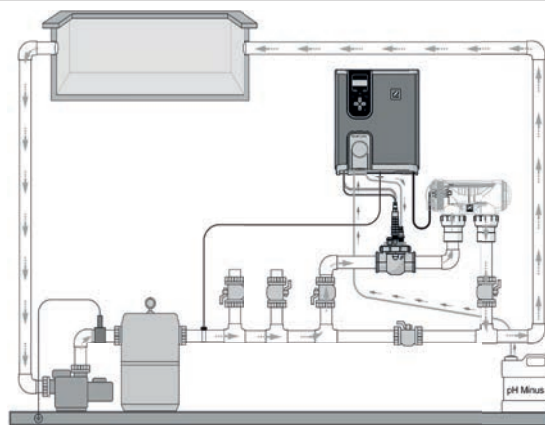

Installing the chlorinator + optional module
(Example with eXO® (iQ))



- The cell must always be the last element placed on the pool return pipe (see diagram).
- It is always recommended to install the cell on a by-pass. This assembly is **MANDATORY** if the flow is in excess of 18 m³/hour to avoid head loss.
- If you installed the cell on a by-pass, it is recommended to fit a check valve downstream from the cell instead of a manual valve, to avoid any risk of incorrect configuration which could result in poor circulation inside the cell.

2.1.1 eXO® (iQ) cell

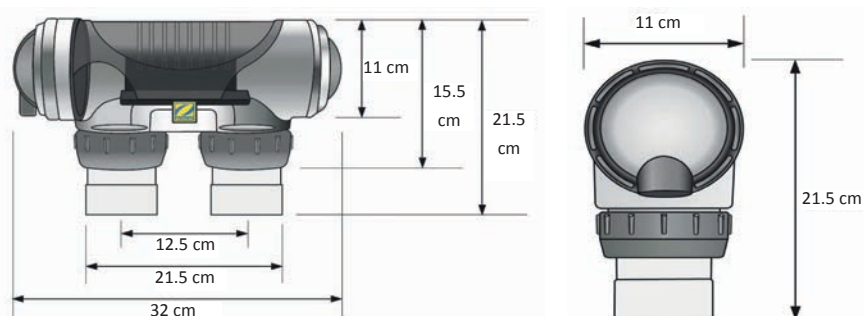

- Make sure that the cell is placed **HORIZONTALLY**. The water should flow from the electric connections towards the opposite side.
- Use the screw-on fittings to fix the cell to the pipes.
- For Ø63 mm pipes, glue them directly to the screw-on fittings. For Ø50 mm pipes, use glue-on PVC adapters of the corresponding diameter (grey models; the white models are for 1 ½" UK pipes).
- Connect the cell power cord following the wire colour codes (red, black and blue connectors) and then refit the protective cap. The two red wires can be connected to one or the other red terminals on the electrode.

2.1.2 GenSalt OT cell

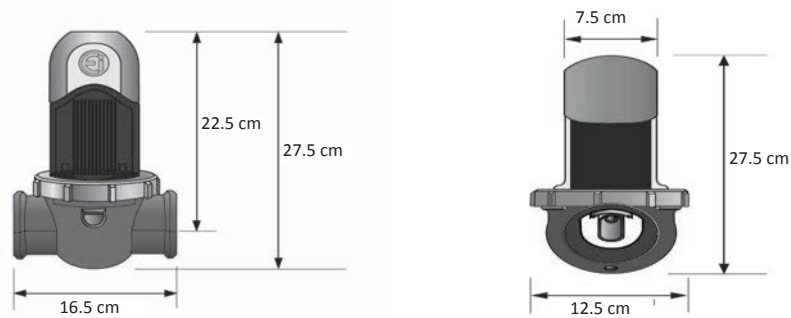

EN

- The cell must be installed on a horizontal pipe so as to guarantee that the water flow passing therethrough is primarily horizontal, and that the angle/slope does not exceed 30°. The pipe must have a free horizontal length of at least 30 cm, on which the cell will be installed. The cell must also be installed as far as possible from any right angle or curve formed in the piping (**B**).
- Respect the water flow direction (see arrows (**C**)).

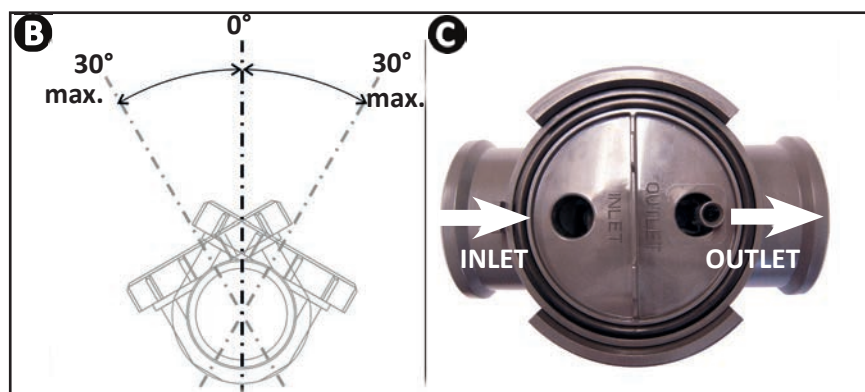

- Dismantle the cell (**D**).
- Position the EU pipe adapter (DN50 mm) upside down at the position where the pipe (**E**) will be installed.
- Use a drill bit or centre-punch to mark the positions of the holes to be drilled on the pipe, remove the EU pipe adapter (DN50 mm) and drill the holes using the hole saw supplied.
- Check that the edges are perfectly smooth and deburred (use abrasive paper for example).
- Clip together the lower and upper parts of the cell collar on the pipe at the holes, respecting the water flow direction (use the "EU" Ø50 adapter for a Ø50 mm pipe).
- Position the top transparent part of the cell (presence of a foolproof locating notch), position the compression ring on the thread of the upper collar by aligning the point (**F**) of the collar with the arrow of the collar (**G**), then tighten firmly by hand (do not use a tool).

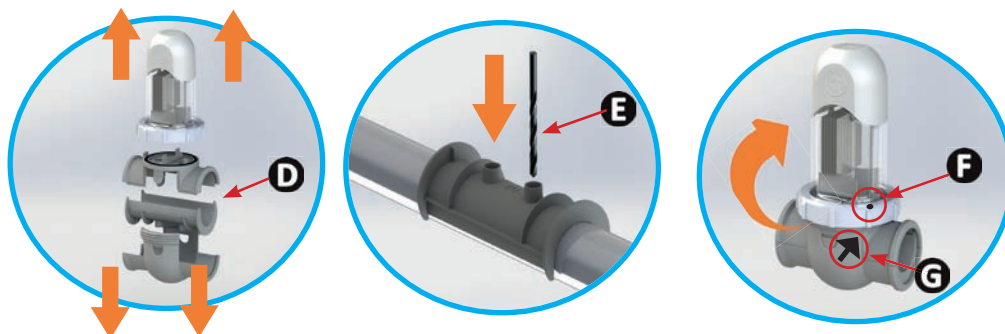

- Connect the cell power cord in compliance with the wire colour codes (red, black and blue connector(s)) and then fit the protective cap. **For GenSalt OT 10**, the second red connector will not be connected; leave it as it is before positioning the protection cover.

2.2 I Installing the temperature sensor (depending on the model)

- The water temperature sensor displays the water temperature value on the appliance screen and manages chlorination according to the temperature. The sensor must measure the temperature of the water upstream of any possible heating system.
- The sensor is designed to be mounted on rigid $\varnothing 50$ mm, $\varnothing 63$ mm or $\varnothing 1 \frac{1}{2}$ " PVC pipes. Do not install on any other type of pipe.
- Install the sensor either between the filter pump and the filter, or between the filter and any other downstream equipment, see "2.1 I Installing the cell":
 - Drill a hole in the pipe using a $\varnothing 9$ mm (max. $\varnothing 10$ mm) drill bit, then deburr the hole,
 - Install the O-ring provided on the sensor body,
 - Secure the sensor using the stainless-steel clamping collar provided. Do not use excess strength.

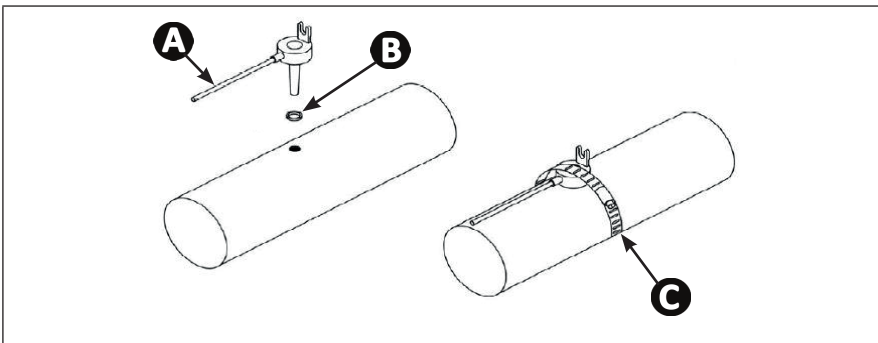

- A**: Sensor
- B**: O-ring
- C**: Stainless steel clamping collar

2.3 I Installing the flow switch (chlorinator only without pH Link or Dual Link modules)



In cases where a pH Link or Dual Link module is used, the flow switch will be installed on the POD Kit, see "3.3 I Installing the flow switch on the POD kit"

- The flow switch and its 50 mm diameter fixture collar supplied as standard (63 mm diameter available as a spare part) must be installed immediately before the cell and after any valves present (1). Use the threaded adapter and the Teflon tape provided to install the flow switch on its fixture collar.
- Screw the flow switch using the clamping nut only (screw by hand!) (2).

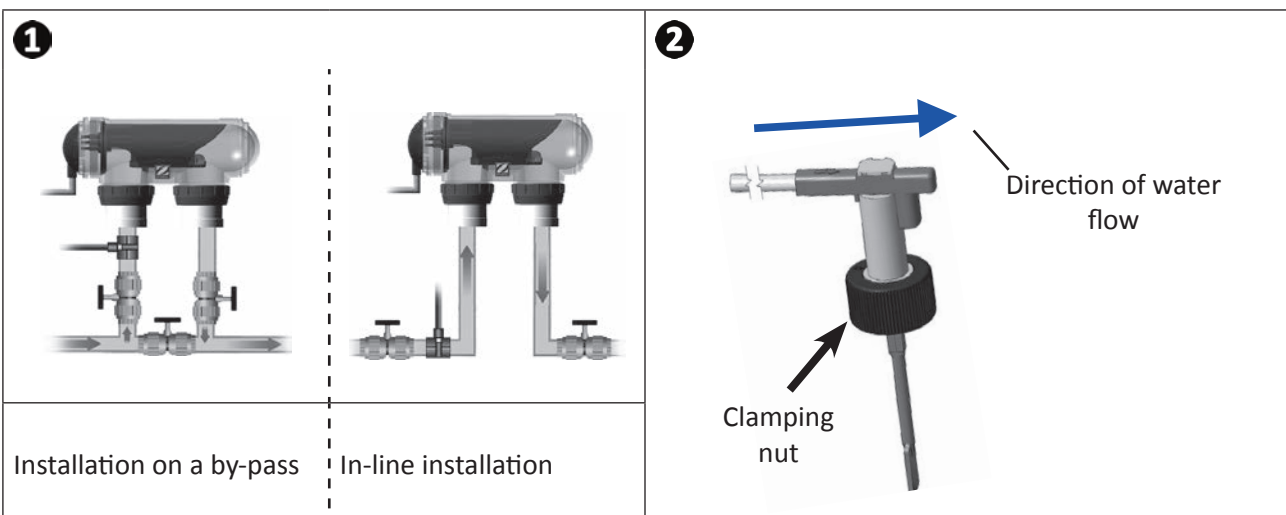

- Failure to comply with these instructions could lead to the destruction of the cell! The manufacturer cannot be held liable in this case.
- The flow switch has a direction for installation (arrow indicated on it showing the flow direction for the water). Make sure that it is correctly placed on its fixture collar so that it stops the appliance's production when filtering is stopped.

2.4 I Installing the control box

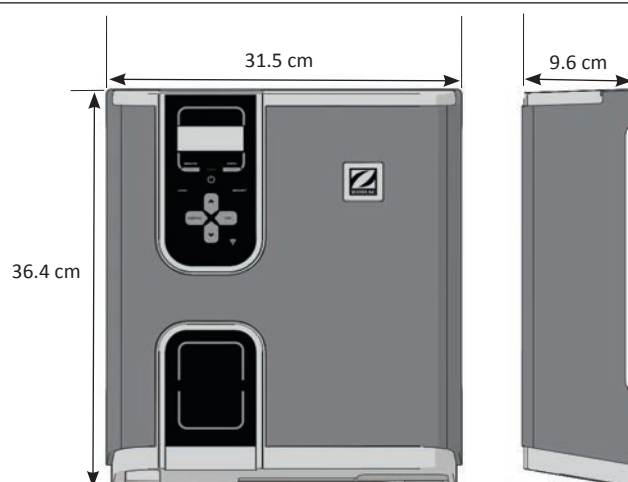

EN

- The control box must be installed in a dry ventilated technical room protected against frost, with no pool maintenance products or similar products stored nearby.
- The control box must be installed at a distance of at least 3.5 m from the outside edge of the pool. Always comply with the installation codes and/or laws applicable at the place of installation.
- It must not be installed more than 1.8 metres from the cell (maximum cable length).
- If the box is fixed to a post, a watertight panel must be fixed behind the control box (350x400 mm minimum):
 - Attach the metal mounting below to the wall or to the watertight panel using the screws and wall plugs provided, (see figure 1).
 - Fix the control box to the metal support by moving 1 (downwards) and 2 (rightwards) in order to lock the box onto its support, (see figure 2).

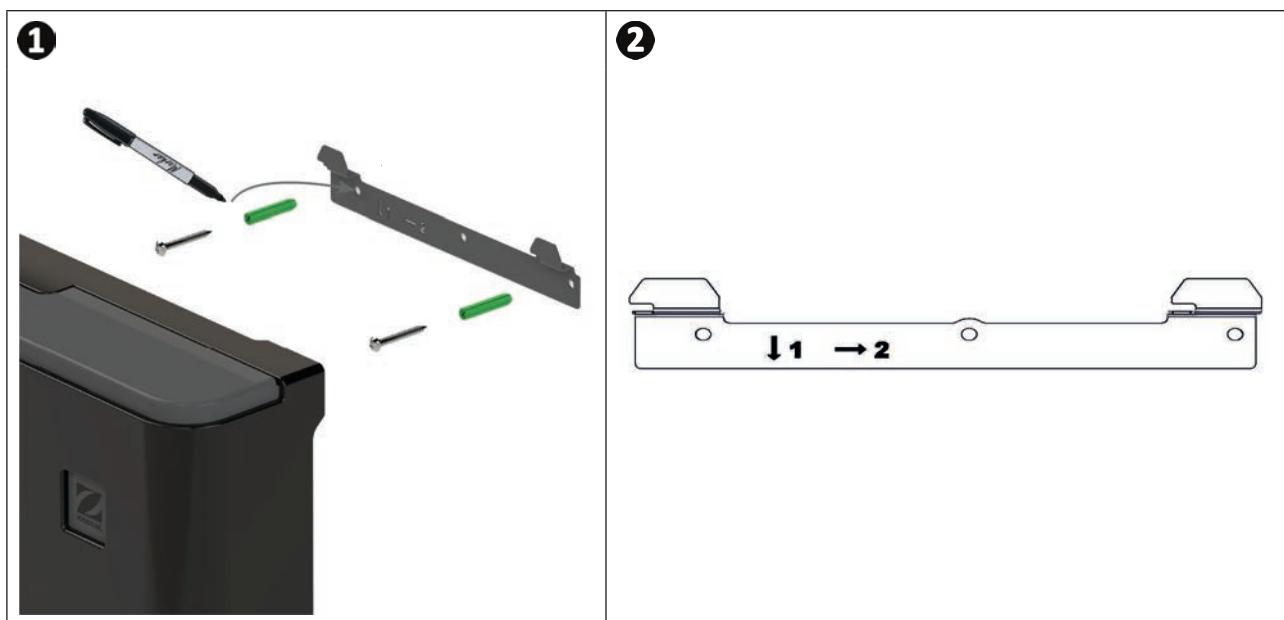

Using Wi-Fi Direct mode (depending on the model): Use a smartphone (Settings/Wi-Fi menu) to check that the home Wi-Fi network can be detected when choosing the best location for the control box. A Wi-Fi extender or powerline adapters with Wi-Fi hotspot (not supplied) may be required in some cases.

2.5 | Electrical connections

Many devices can be connected to the control box in order to control the pool equipment (filter pump, lighting, auxiliary systems, etc.).

The appliance must be permanently plugged in to the power supply (power supply protected by a 30 mA residual current circuit breaker).



- Turn the appliance off. Before beginning, disconnect all potential power supplies to the appliance.

2.5.1 Accessing the electrical terminal blocks

- Make sure that the appliance is powered off.
- Remove the aesthetic housing from the control box (clipped in place), (see figure 1 or 2 depending on the model).
- Remove the bottom protective cover from the appliance by unscrewing the 2 side screws (see figure 3).

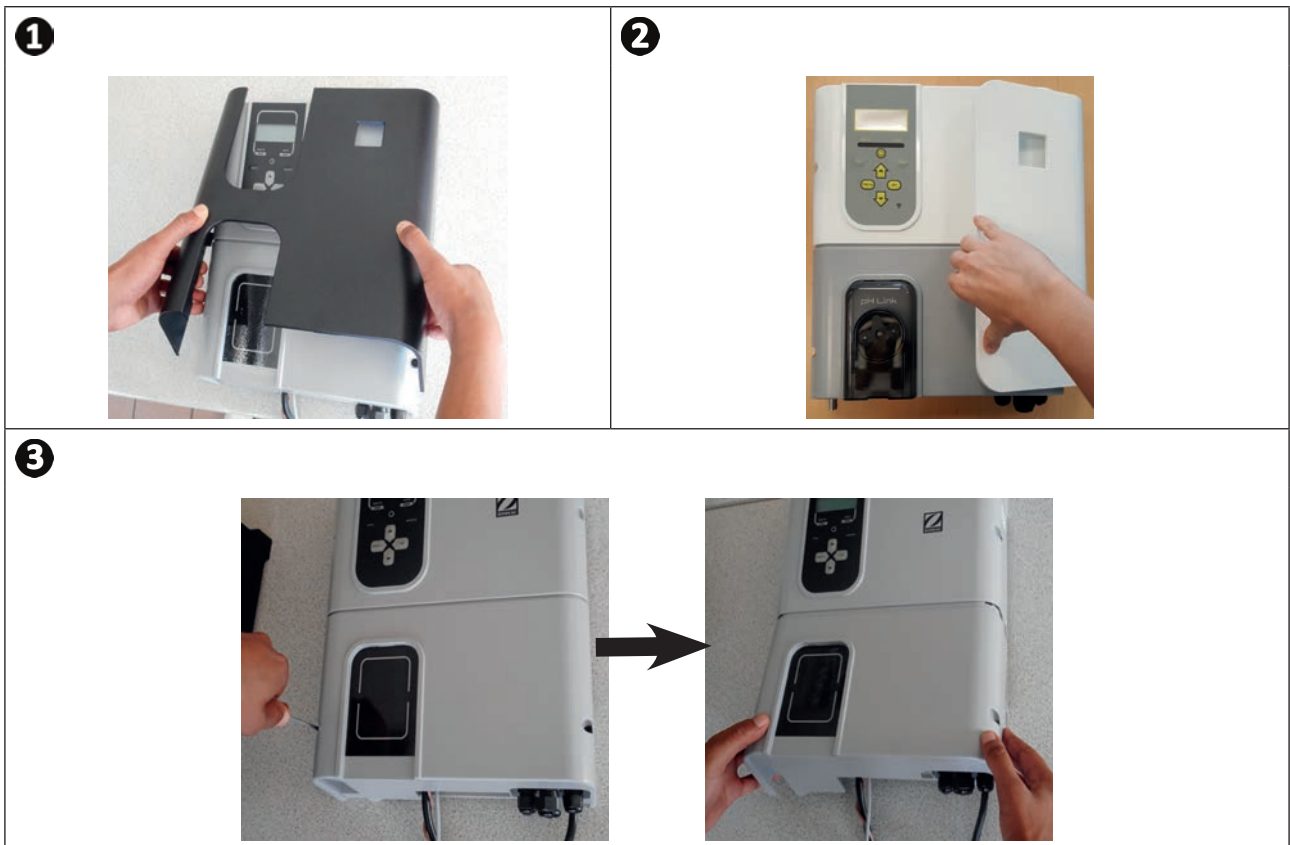

2.5.2 Identifying the functions to be connected

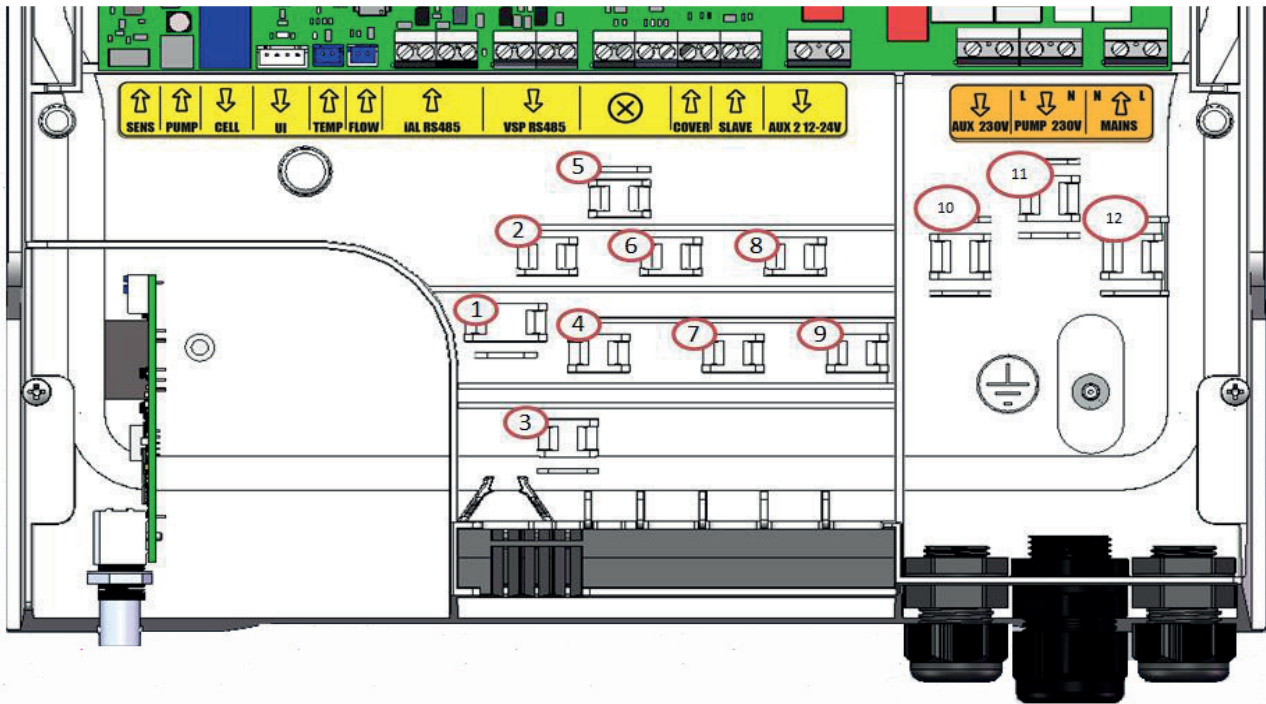

EN

Terminal block messages	Type	Cable clamp	Functions	eXO® (iQ)	GenSalt OT	With pH Link or Dual Link
SENS	Input	-	Connection for the control board for pH Link and Dual Link modules	/	/	⚠
PUMP	Input	-	Connection for the pH regulation pump for pH Link and Dual Link modules	/	/	⚠
CELL	Output	1	Connection for the electrolytic cell	✓	✓	✓
UI	Output	-	Connection for the display	✓	✓	✓
TEMP	Input	3	Connection for the temperature sensor	✓	/	✓
Flow	Input	2	Connection for the flow switch	✓	✓	✓
iAL RS485	Input	4	<i>Function not used – do not wire</i>	/	/	/
VSP RS485	Output	5	Connection dedicated to controlling the Zodiac® variable-speed filter pump	+	/	+
⊗	/	-	<i>Function not used – do not wire</i>	/	/	/
COVER	Input	7	Connection for the roller shutter/cover for automatically managing the LOW function	+	+	+
SLAVE	Input	8	Connection for an external appliance for the ON/OFF control of the chlorinator (automatic regulation, etc.)	+	+	/
AUX 2 12-24V	Output	9	Connection dedicated to the ON/OFF control of a low-voltage device. Connection used to control a heating system. This connection does not power the device: it manages the ON/OFF function.	+	+	+
AUX 1 230V	Output	10	Connection dedicated to the ON/OFF control of a high-voltage device. This connection does not power the device: it manages the ON/OFF function.	+	/	+
PUMP 230V	Output	11	Connection dedicated to the power supply to the pool filter pump.	+	+	+
MAINS	Input	12	Mains power supply to the appliance 110-240 VAC - 50/60 Hz	✓	✓	✓

✓: Connections made during manufacture
 ⚠: Mandatory connections to be made
 +: Function to be connected (optional)

2.5.3 Electrical connection steps

- Identify the functions to be connected and locate the position of the cable clamp, see “2.5.2 Identifying the functions to be connected”.
- Check that the cables used comply with the intended use and with the regulations in force.
- Identify the input for each desired function at the bottom of the control box:

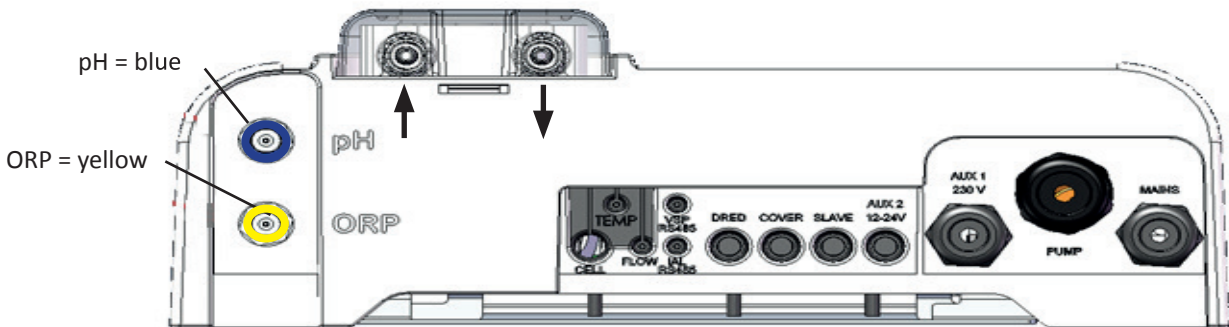

View from below of a control box *with an installed module*

- Pass the cable into the associated cable gland or pierce a hole in the PVC diaphragm (made of rubber) using a screwdriver of an appropriate diameter.
- Identify the terminal block dedicated to the desired function using the identification zones:

	Low-voltage part
	High-voltage part

- Install a cable clamp (supplied) to mechanically hold the cable against the appliance's frame; the position of the cable clamp is shown, see “2.5.2 Identifying the functions to be connected”.
- If the filter pump (single- or variable-speed pump) is connected to the chlorinator, it must be grounded using the dedicated grounding stud by crimping an appropriately-sized lug for the wire (not supplied).

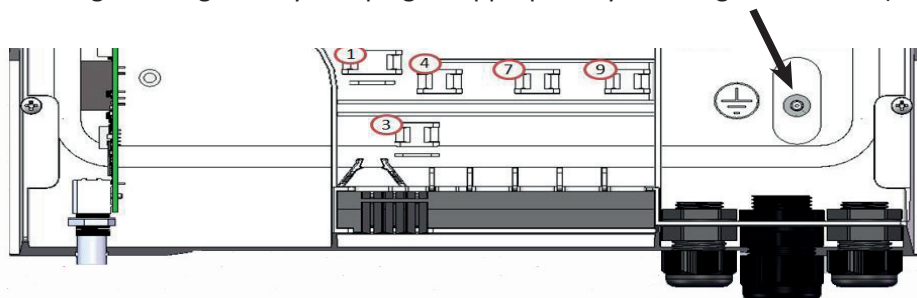

2.5.4 External connections: what products should be connected?

The chlorinator must be protected by a circuit breaker of the same type as that used for a filter pump (for example a filtration control panel).

If the chlorinator is powered by a filtration control panel, the timers must be manually set to 24/7 mode. The chlorinator manages all timers and must receive a continuous power supply.

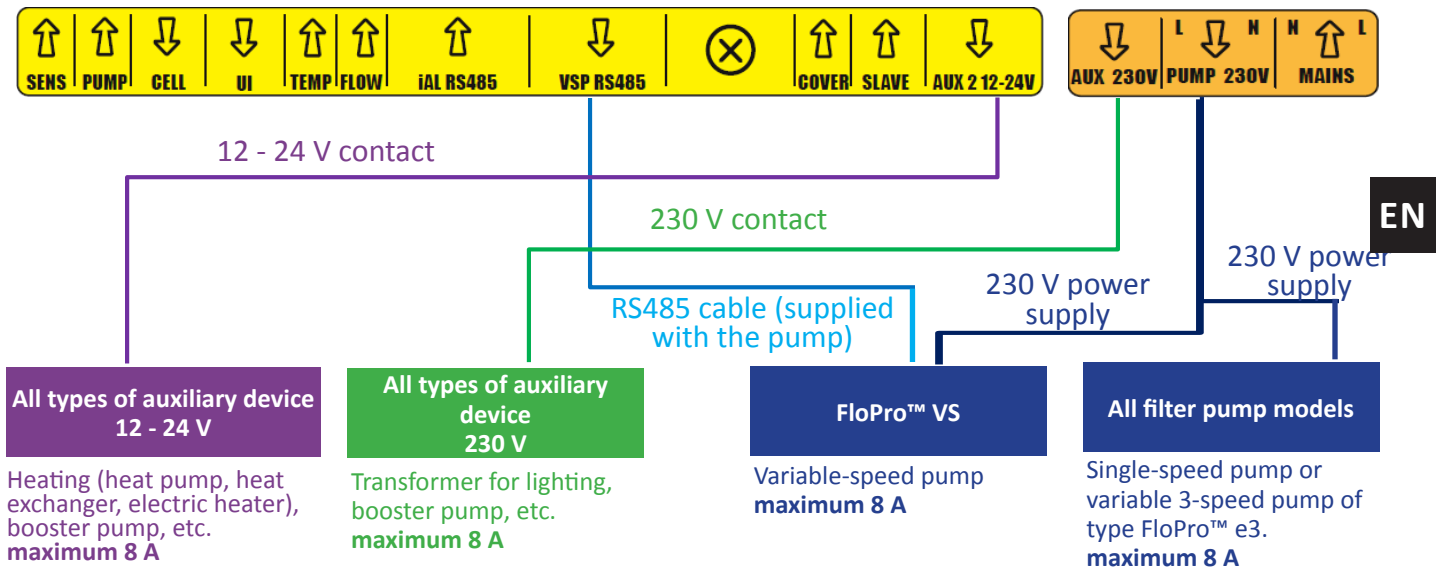

EN

2.5.5 Connecting to a filter pump (depending on the model)

The chlorinator can power and control the filter pump.

In such a case, the chlorinator must be powered via an electrical protection that is calibrated for a filter pump.

Possible controls:

- For a single-speed pump (SSP): ON/OFF with 2 timers,
- For a FloPro™ VS variable-speed pump (VSP): ON/OFF/RPM with 4 timers.

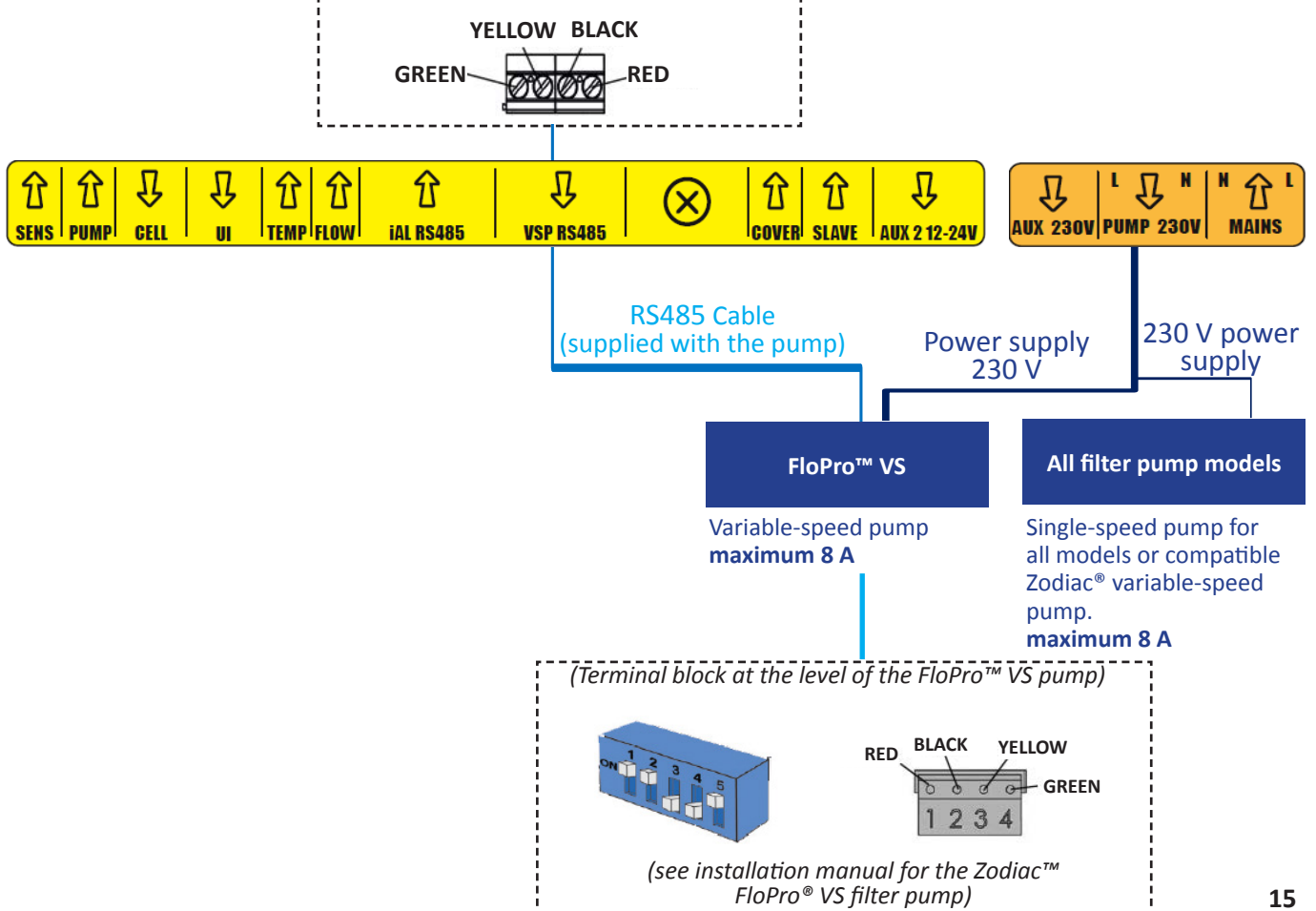

2.5.6 Connecting to an auxiliary device = AUX 1 - Dry contact provided for disconnection from the 230V power supply (depending on the model)

The chlorinator manages a dry contact calibrated for disconnection from the 230V power supply. The power supply is separated with its own protection (circuit breaker calibrated to suit the equipment controlled or its transformer – max. 8 A).

Preferred connection for NL LED spotlights.

Possible controls: ON/OFF with timer for all monochromatic spotlights, ON/OFF/Colour with NL RGBW LED spotlights

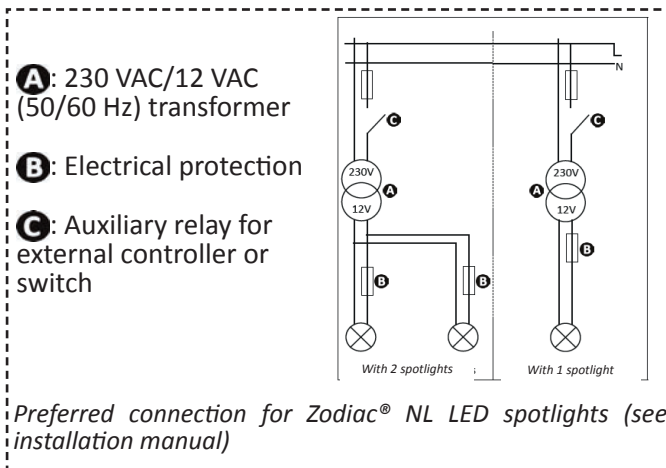

230 V contact

All types of auxiliary device 230 V

Transformer for lighting, booster pump, etc. maximum 8 A

2.5.7 Connecting to a heating system = AUX2 - 12-24V

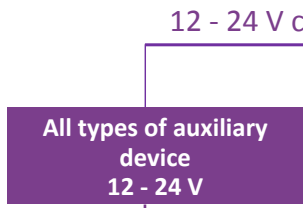

EN

Heating system with remote on/off control

1. Use an appropriate length of a 2 x 0.75 mm² cable (not supplied).
2. Use this cable to connect the appliance contact (AUX2) to the remote on/off control of the heating system (see connection details in the associated installation manual).
3. Turn the heating system on. Set the temperature setpoint of the heating system to its maximum (and set to the desired mode if there are several heating modes available). The chlorinator will use the water temperature measured by its sensor to manage the activation of the heating system according to the temperature setpoint.

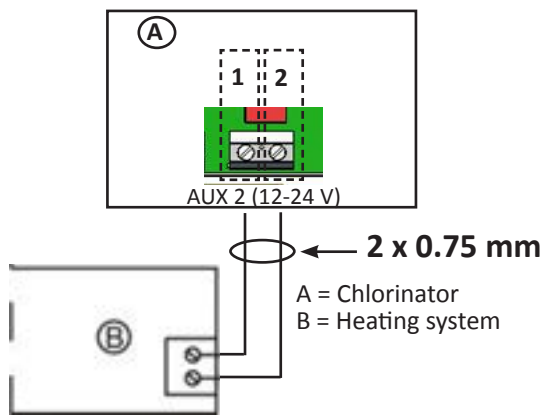

Connection of a heating system with remote on/off control

Heating system without remote on/off control

1. Use an appropriate length of a 2 x 0.75 mm² cable (not supplied).
2. Disconnect one of the 2 flow switch (D) wires from the terminal block of the heating system (B) (refer to the manual if necessary).
3. Connect the wire from terminal 1 of the chlorinator (A) in place of the flow switch (D) wire that was disconnected from the terminal block of the heating system (B).
4. Connect the disconnected flow switch wire (step 2) with the wire from terminal 2 of the chlorinator (A) using a suitable connection terminal (C).
5. Turn the heating system on. Set the temperature setpoint of the heating system to its maximum (and set to the desired mode if there are several heating modes available). The chlorinator will use the water temperature measured by its sensor to manage the activation of the heating system according to the temperature setpoint.

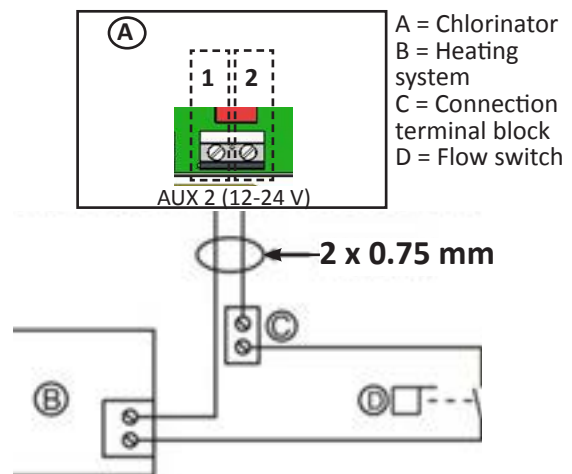

Connection of a heating system without remote on/off control

2.5.8 Reassembling the appliance

- Position the bottom protective cover (or the pH Link/Dual Link module) on the appliance and screw in the 2 side screws (see figure **1**).
- Clip the aesthetic housing of the control box in place (see figure "**2**a" or "**2**b" depending on the model).

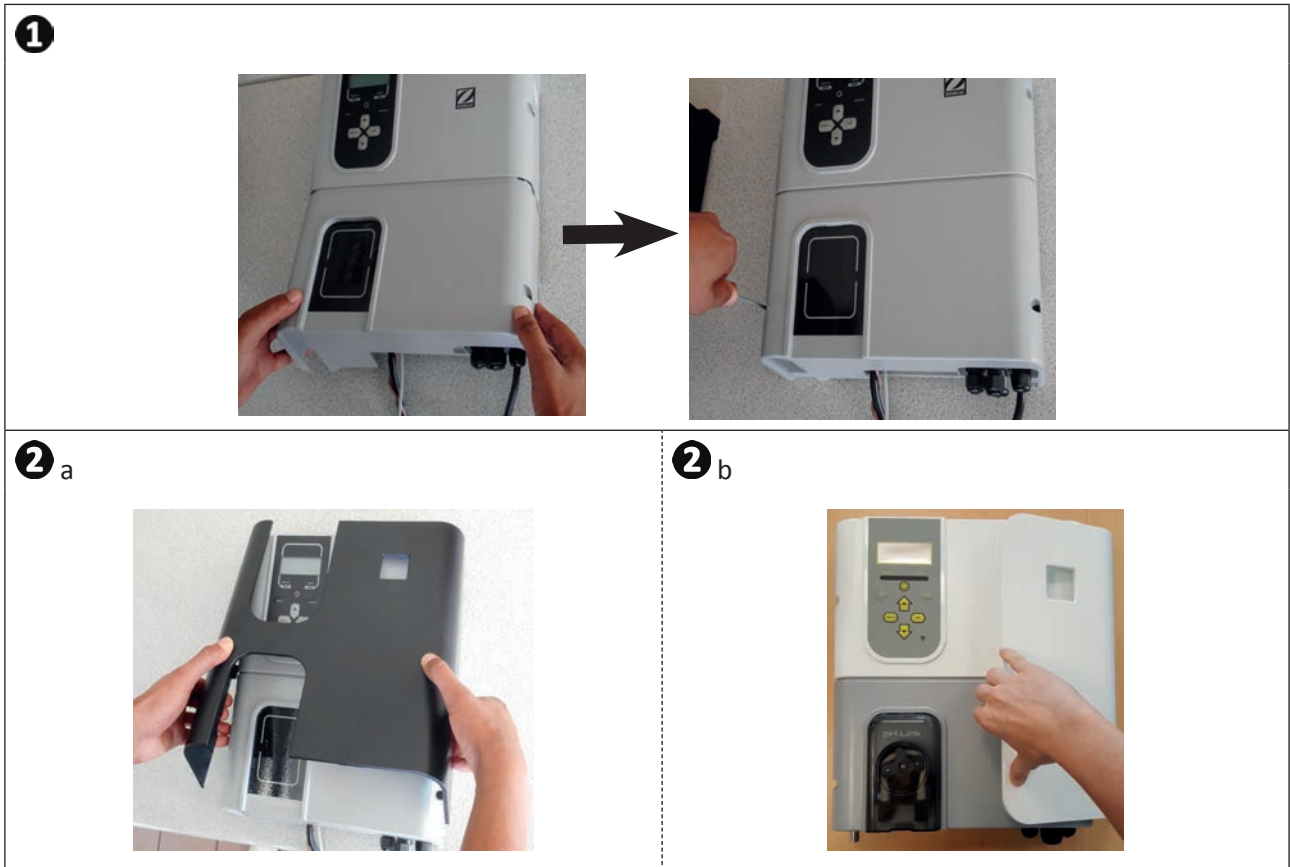

- If a pH Link or Dual Link module has been installed, do not reconnect the electricity supply until the module, the POD kit and the pH minus injection pipe have been installed.



3 Installing a pH Link or Dual Link module

3.1 I Installing the module



- Turn the appliance off. Before beginning, disconnect all potential power supplies to the appliance.

- Close the isolating valves in the pipework.
- Remove the cover (if necessary) according to step **A** or **B** depending on the model, see figure **1**.
- Unscrew (x2) and remove the bottom module, see figure **2**.
- Connect the 2 cables "SENS" and "PUMP" of the pH Link or Dual Link module to the chlorinator's terminals, see figure **3**.
- Position the module on the chlorinator according to step **C** and screw (x2) according to step **D**, see figure **4**.
- Reposition the cover **A** or **B** depending on the model, see figure **1**.

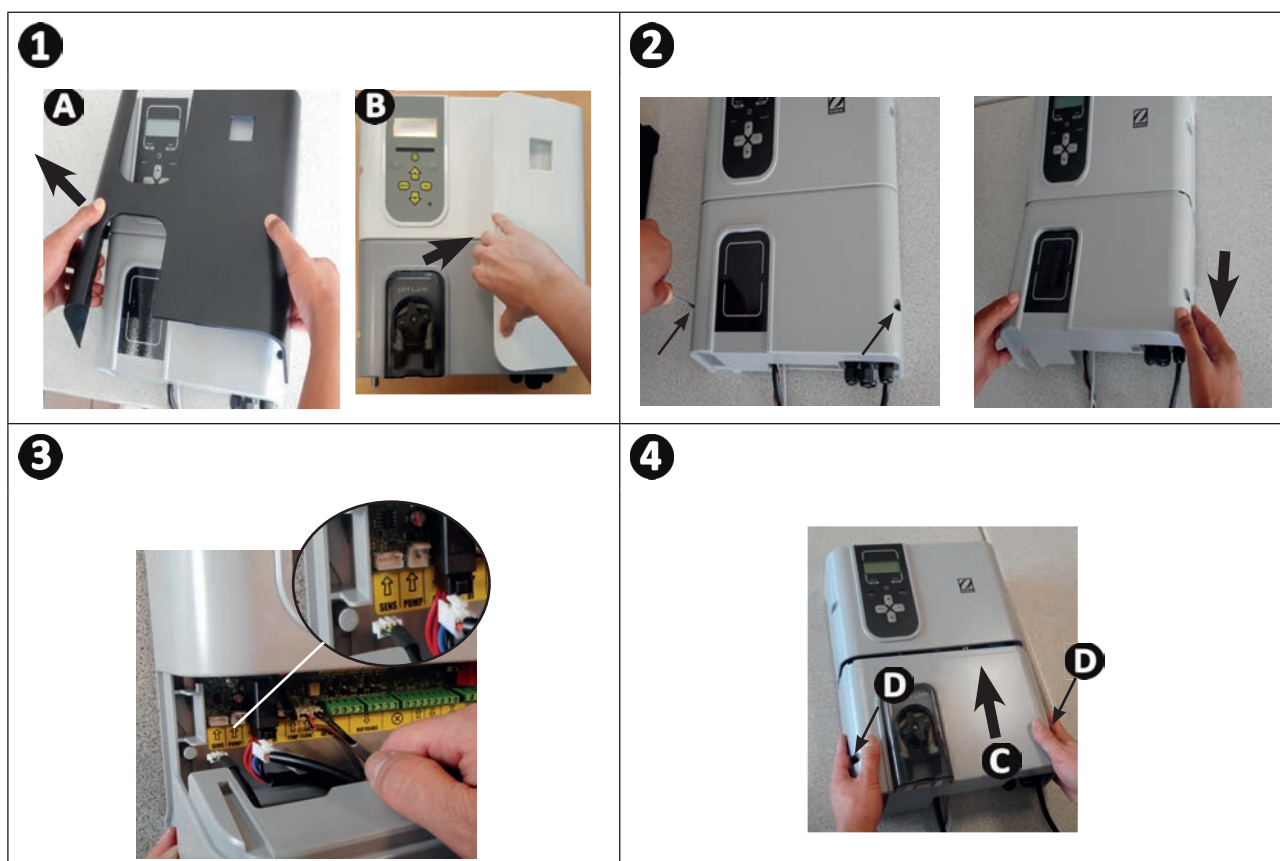

3.2 I Installing the POD kit

The POD Kit is a measuring chamber using patented Quick Fix® technology for installation on a rigid 50 mm PVC pipe (with supplied adapter) or 63 mm PVC pipe (without adapter). It contains the following components:

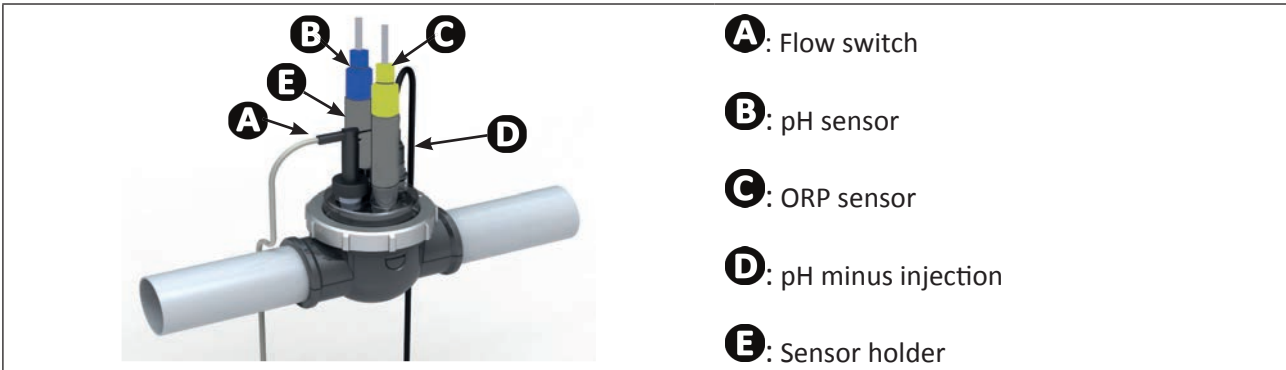

3.2.1 Recommended positioning



- The cell bypass valves must always be open.
- The sensor-holding POD kit must always be positioned on a horizontal pipe so that the sensors are vertical.
- The POD kit must be the first unit fitted after the pool filter.
- If the pool is fitted with an electric heater, the POD kit must be installed upstream of the heater (to take readings on unheated water).
- We recommend positioning the POD kit more than 20 cm from an elbow in the pipe.
- The sensor cables must not be positioned near high voltage mains electricity cables.

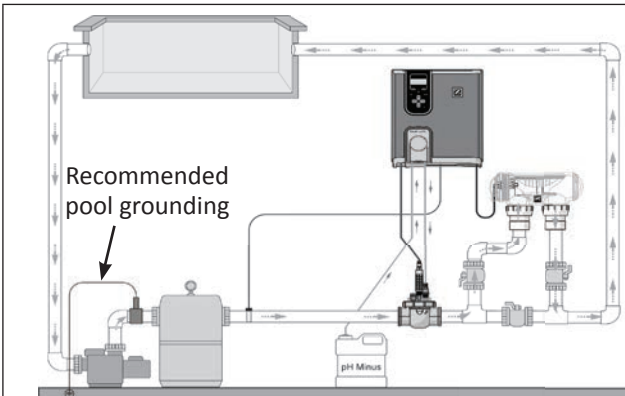

In-line installation

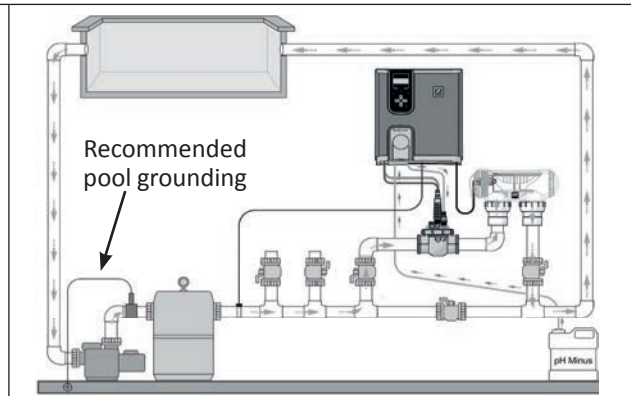

Installation on a by-pass

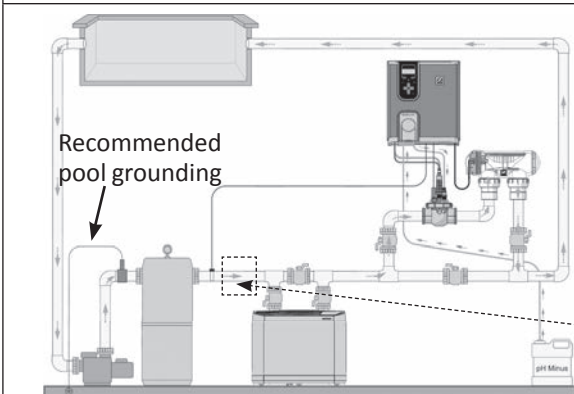

Installation with a heating system



- If an electric heater is installed (instead of a heat pump), place the POD kit before this heater (in order to measure unheated water). In this case, the flow switch must be placed on the bypass on the fixture collar.

3.2.2 Preparing the pipe

- Identify a suitable length (minimum 30 cm, without elbow) of straight pipe.
- Dismantle the POD kit to retrieve the EU pipe adapter (DN50 mm) provided with 2 perforations, **see figure 1**.
- For a DN50 mm pipe, use the EU DN50 mm pipe adapter (or use the DN63 mm bottom collar). Position it on the pipe in a recommended position, **see “3.2.1 Recommended positioning”**. Use a centre-punch or marker pen to mark the position of the holes to be made in the pipe, **see figure 2**.
- Using the hole saw supplied, cut the 2 feed holes for the POD kit, **see figure 3**.
- Ensure that the edges of the holes are smooth and deburred, **see figure 4**.

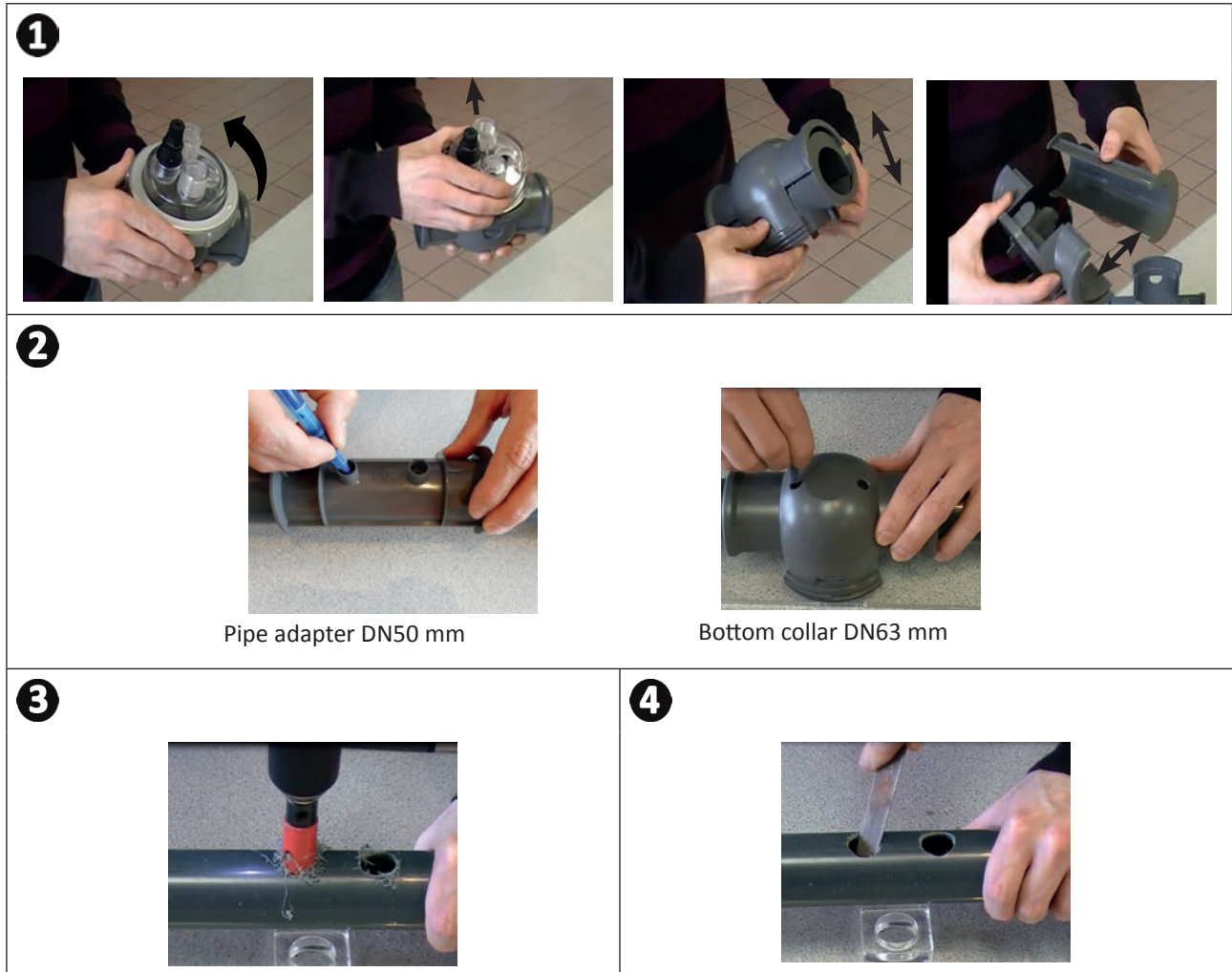

3.2.3 Installing the POD kit on the pipe

- For a $\varnothing 50$ mm pipe, use the adapter labelled "EU". Clip the 2 parts of the POD kit collar around the pipe. Make sure that the adapter is properly centred according to the guides; the adapter must stay in this position once all parts have been assembled. Do not use this adapter for a $\varnothing 63$ mm pipe, **see figure 1**.
- Install the bottom and top collars of the POD kit on the pipe according to the position of the holes and the water flow direction (follow the arrows), **see figure 2**.
- Position the top part with its different components in the direction shown by the foolproofing key, align the point **C** of the compression ring with the arrow **D** of the bottom collar and tighten the compression ring well (tighten by hand only!), **see figure 3**.
- To determine whether tightening is correct, check that the compression ring is level, **see figure 4**.

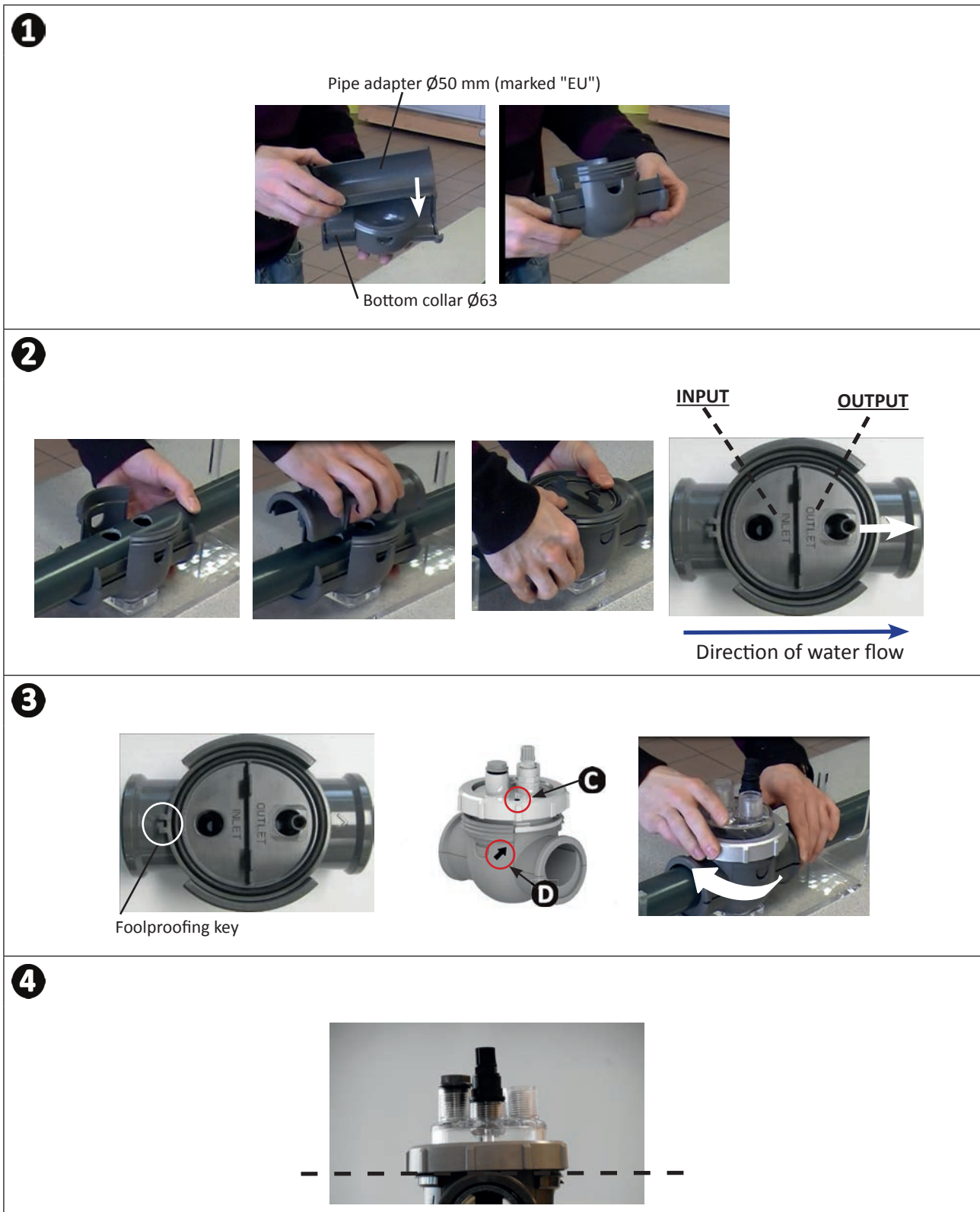

▶ 3.3 I Installing the flow switch on the POD kit

- Take the flow switch provided with the appliance control box.
- Place it inside the housing provided for this purpose on the POD Kit and screw in place.
- Screw using the clamping nut only (screw by hand only!).



- The arrow showing the direction of water flow on the top of the flow switch must be perfectly parallel with the piping on which the POD kit is positioned.

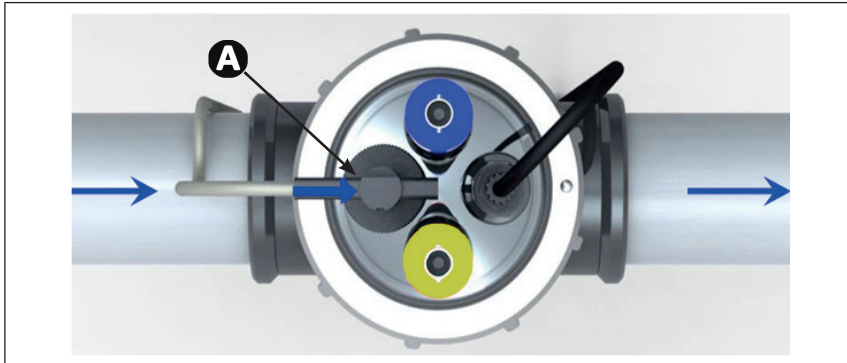

A: Flow switch

▶ 3.4 I Installing the sensors on the POD kit

- Screw the one or more threaded sensor holders onto the POD kit, see figure ①.
- Carefully unscrew the protection tube from the sensor, see figure ②. Keep the protection tube for storing the sensor over winter.
- Rinse the end of the sensor with tap water and shake off excess water, see figure ③.



- Never wipe the sensor using a cloth or paper tissue, as this may damage it.
- A badly-installed sensor may give false readings and cause inappropriate operation of the appliance. Neither the manufacturer nor the appliance shall be liable in this event.

- Screw the sensor into the sensor holder by holding the BLUE or YELLOW tip in one hand and the black tip in the other hand to prevent the cable from tangling, see figure ④.
- Once the sensor has been installed on the POD kit, it can be connected to the BNC socket (BLUE = pH; YELLOW = ORP) of the pH Link or Dual Link module, see “2.5.3 Electrical connection steps”, see figure ⑤.
- The sensor must then be calibrated, see “5.3 I Calibrating the sensors (if an optional “pH Link” or “Dual Link” module has been installed)”

①



②



③



④



⑤



3.5 I Installing the pH minus injection and suction hoses



- When handling chemical products, always use appropriate safety equipment (safety glasses, gloves and jacket).



The peristaltic pump rotates in the clockwise direction. The acid (pH minus) is therefore fed into the left side of the pump and injected into the tank from the right. The direction of flow of the pump can be identified on the pH Link or Dual Link module from the two dedicated arrows.

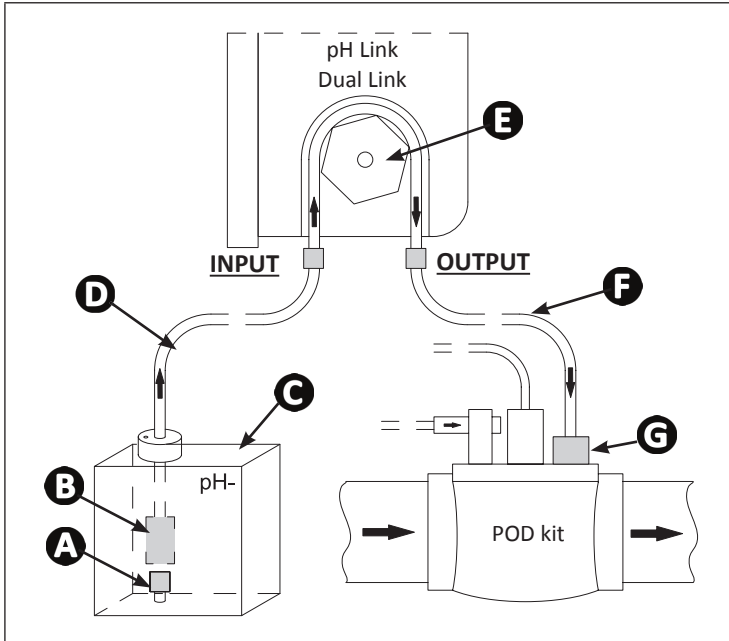

- A**: Support tip
- B**: Ceramic weight
- C**: pH minus container
- D**: Suction hose
- E**: Peristaltic pump
- F**: Injection hose
- G**: Injection check valve

EN

3.5.1 Installing the pH minus injection line

- Remove the protective cover from the peristaltic pump, see figure 1.
- Cut a suitable length of hose from the coil supplied to connect the peristaltic pump to the injection check valve of the POD kit.
- Unscrew the connector cap and attach the hose to the connector at the outlet of the peristaltic pump, see figure 2.
- Attach the other end of the hose to the injection check valve of the POD kit, see figure 3.



3.5.2 Installing the pH minus suction line

- Cut a suitable length of hose from the coil supplied to connect the container of pH minus to the peristaltic pump.
- Unscrew the connector cap and attach the hose to the connector at the outlet of the peristaltic pump, see **figure 1**. Screw the cap in place.
- Reposition the protective cover on the peristaltic pump.
- Drill two holes into the cap of the pH minus container, see **figure 2**:
 - One hole suited to the diameter of the hose to aspirate the product.
 - One smaller hole to prevent the container from becoming deformed during aspiration of the product.
- Pass the free end of the hose through the hole made in the cap and put the ceramic weight provided and the support tip on the hose, see **figure 3**.
- Ensure that ALL connections are correct and watertight before operating the appliance.

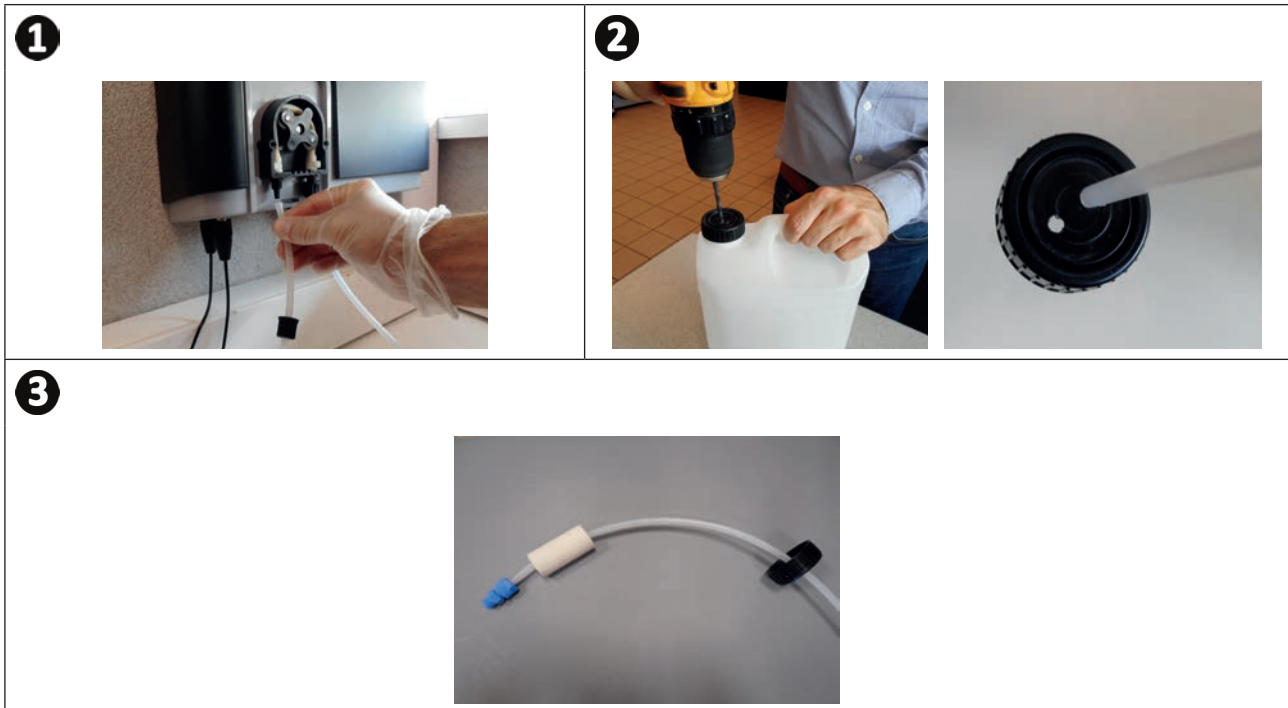

Do not place the pH minus container directly beneath electrical equipment in the technical room to prevent risk of corrosion resulting from potential acidic vapours.



4 Preparing the pool

4.1 I Balancing the water

The water used must originate from a supply network compliant with Directive 98/83/EC on the quality of water intended for human consumption. In order for the water to be treated optimally, carry out measurements and adjust the values in accordance with the following recommendations:

4.1.1 Seasonal analyses in "preparation for re-use"

- **Stabiliser (cyanuric acid) (<30 mg/L, ppm):** the stabiliser protects chlorine from the destructive power of the sun's U.V. rays. Excessive stabiliser can block the disinfecting power of chlorine and turn the water turbid.
- **Metals (Cu, Fe, Mn) (± 0 mg/L, ppm):** metals damage the metallic parts of the pool (corrosion phenomenon) or can cause permanent stains.

EN

4.1.2 Monthly analyses

- **TH (10-30°f) or (100 - 300 mg/L CaCO₃, ppm):** the TH measures the water hardness (quantity of calcium carbonate), and this value can vary significantly depending on the geographical region concerned.
- **TA (8-15°f) or (80 -150 mg/L CaCO₃, ppm):** the TA measures the water alkalinity, and this value allows the pH to be stabilised. It is important that the TA is adjusted before the pH.

4.1.3 Weekly analyses

- **pH (7.0 - 7.4):** the pH measures the acidity or alkalinity of the water. A pH in the range 7.0 to 7.4 helps to preserve the pool equipment and maintain effective disinfection. **Taylor's balance method, as shown below, is used to adjust the pH value:**

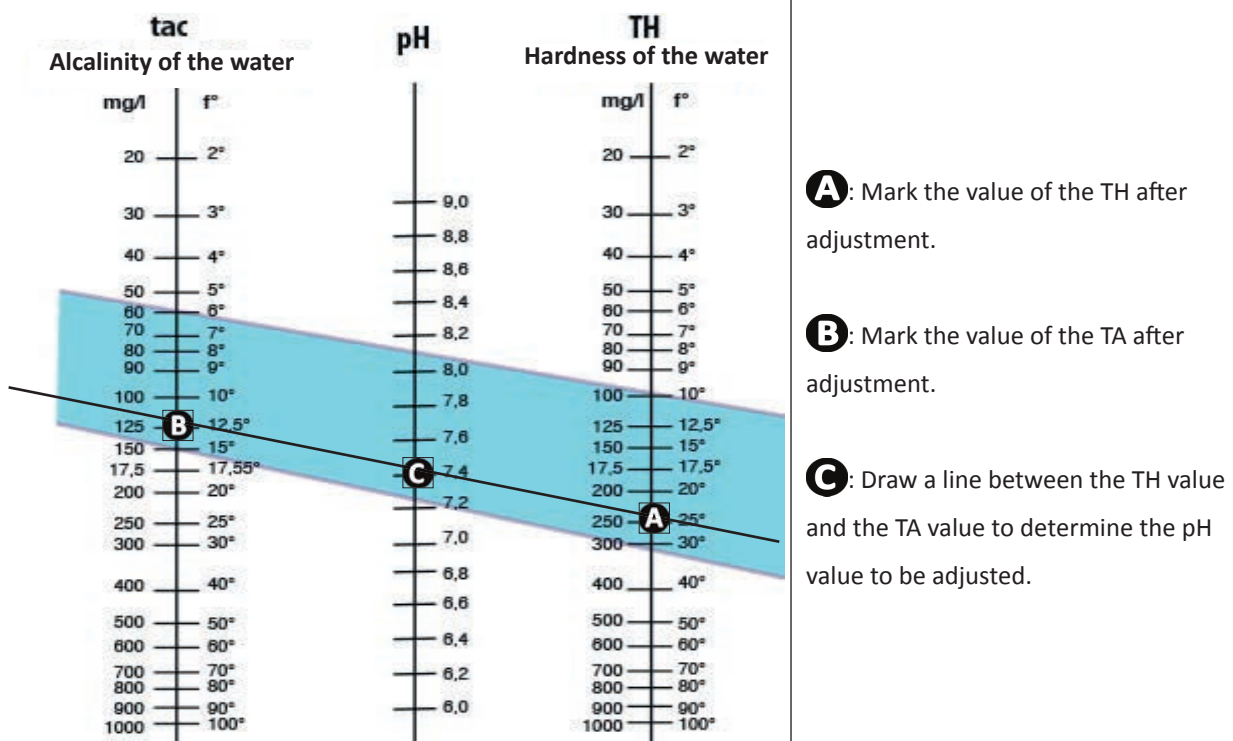

A: Mark the value of the TH after adjustment.

B: Mark the value of the TA after adjustment.

C: Draw a line between the TH value and the TA value to determine the pH value to be adjusted.

Taylor's balance

- **Free chlorine (0.5 - 2 mg/L or ppm):** this quantity of free chlorine makes the water both disinfected and disinfecting.



Contact your retailer to determine the type of corrector product or automatic control appliance to be used to adjust the values.

➤ 4.2 I Adding salt

Every appliance must be operated with a minimum recommended salt level, see "1.2.1 Salt water chlorinator".



In order for the chlorinator appliance to operate properly, and to protect the equipment, we recommend using salt (sodium chloride) as per standard EN 16401.

4.2.1 Determining the quantity of salt to be used when installing the appliance

Example:

- Appliance operating with **4 grams of salt/litre of water**.
- **50m³** pool.

The formula:

$$50\text{m}^3 \times 4 \text{ grams of salt} = \mathbf{200 \text{ kg of salt to be added to the water.}}$$

4.2.2 Routine analyses

Check the salt level quarterly and readjust the quantity of salt present where necessary.

==> Method for adding salt to the water

- Start the filter pump to cause the water in the pool to circulate.
- If the appliance has already been installed, switch it off.
- Move around the perimeter of the pool while pouring the required quantity of salt into the water to help dissolution. Add the salt in stages. It is easier to add salt to make up for an insufficient quantity than to dilute the salt present to make up for an excessive quantity.
- Operate the filter pump for 24 hours.
- After 24 hours have passed, check that the salinity level in the pool is correct, i.e. 4g/litre (*in the example cited*).
- If the salt level is correct and the appliance has already been installed, switch it on then adjust the desired level of chlorine production, see "**5.4.2 Adjusting chlorine production**".



Do not add salt directly to the skimmer.
The appliance must only be switched on when the salt has completely dissolved in the pool.



5 Use

5.1 | User interface



- Before activating the chlorination function on the appliance, check that the salt added to the pool has completely dissolved.

Blue SALTS indicator on steady:
Too low water conductivity (low salt, water too cold, worn cell, etc.)

Activate/Disable LOW mode:
Chlorine production reduced to between 0% and 30% in intervals of 10% (can be configured in the relevant MENU). The "LOW MODE ON" message is displayed.

User menu:
Setting the parameters.

↑ ↓ arrows:

- Browse a menu
- Increase or decrease a setting value
- Lock/unlock the user interface (Press the 2 buttons simultaneously for 4 seconds).

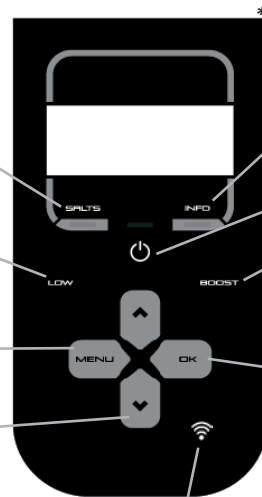

Wi-Fi LED
(depending on the model)

Blue INFO indicator on steady or flashing:
View information or action to be performed on the screen.

Switch on -/Switch off (press and hold)/ Switch to standby (press and release)

Activate BOOST mode:
Chlorine production at 100% for a cumulated 24 hours. The "BOOST ON" message is displayed with the time remaining.

OK button:

- Confirm the highlighted selection
- Delete an error message requiring human intervention (press and hold for 4 seconds)

↑ OK To activate Wi-Fi Direct mode to connect to the iAquaLink™ app (depending on the model)
(Press both buttons until the Wi-Fi LED starts to flash)

See "6.1 | Configuring the appliance before first use".

* The interface graphics may vary depending on the model

5.2 | Configuration before use

5.2.1 Switching on

- Press to switch the appliance on.
- The appliance's information is displayed on start-up:



5.2.2 Setting the language

- On first start-up, the list of available languages is displayed; simply select the desired language using the buttons. Confirm the selection by pressing .
- To change the language at a later point, press and browse using the buttons.
- Confirm the selection by pressing .

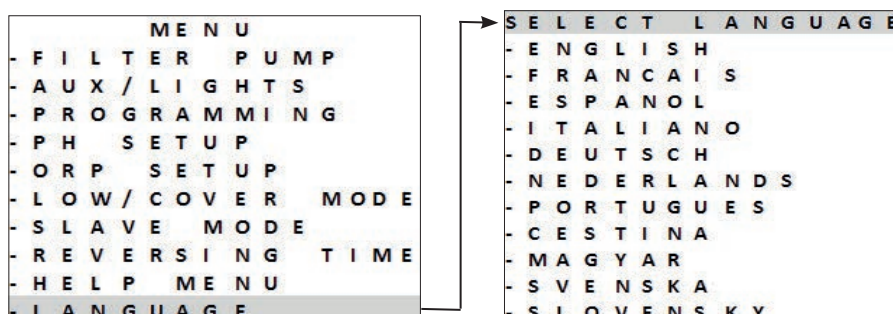

5.2.3 Setting the time

The time must be set for the "TIMERS" filtering programmes and for the "SWC" chlorination programmes to work. The time is set when first using the appliance. If the time must be changed at a later moment, follow the instructions below:

- To change the time, press **MENU** and browse using the **▲** **▼** buttons.
- Confirm the selection by pressing **OK**.

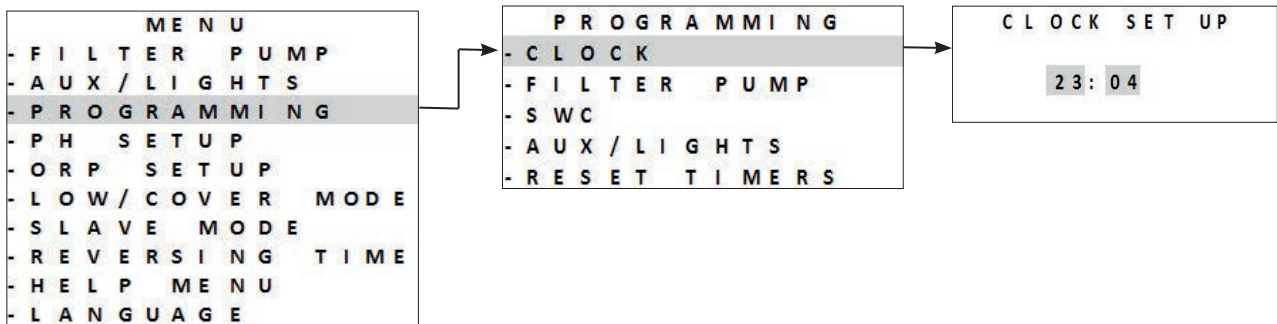

- Press **MENU** to exit.

5.2.4 Selecting the filter pump

The filter pump can be directly connected to and managed by the appliance.

- To achieve this, the filter pump must have already been connected to the power supply, see **"2.5.2 Identifying the functions to be connected"**.
- To declare the presence of the filter pump, press **MENU**. Browse the menu using the **▲** **▼** buttons. Press **OK** to confirm.
- Select the type of filter pump and confirm that the connection has been made properly:

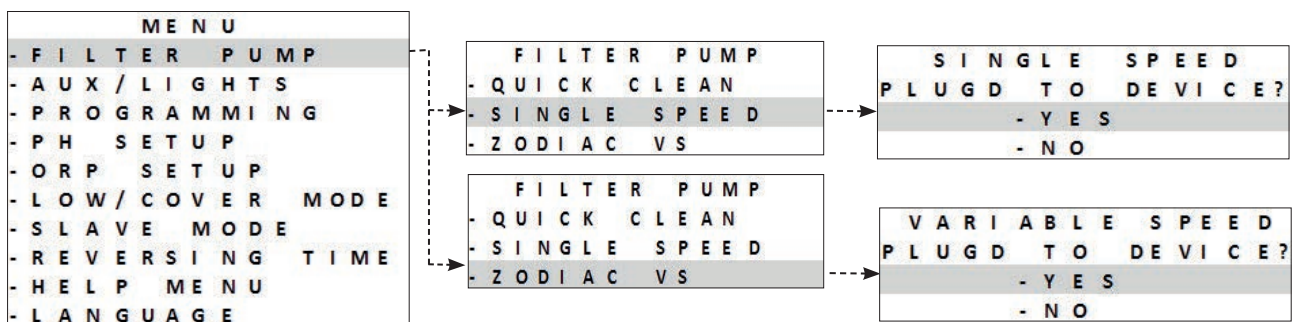

- Continue configuration by programming the "TIMERS" filtration times, see **"5.2.5 Programming the "TIMERS" filtration times"**.

5.2.5 Programming the "TIMERS" filtration times







The timers are used to define the operating duration of the filter pump and the duration of chlorine production by the appliance. They allow the user to operate the variable-speed pump for longer and at lower speeds, without the appliance being in constant operation during this time.

To set the time delay programme, the start and stop times must be entered and confirmed. If no timer has been set, filtration and/or chlorination are constantly active.

The operating times for the filtration system must be sufficient to correctly treat the water.

	<p>Example programmes</p> <ul style="list-style-type: none"> - Filtration time (TIMER) in the pool season for a water temperature of 26° ==> 26/2 = 13 hours of filtration per day - Filtration time (SWC) outside of pool season (active winterising) for a water temperature of 16° ==> 16/2 = 8 hours of filtration per day
---	---

==> Single-speed filter pump

- There are 2 possible programmes, **TIMER 1** and **TIMER 2**.
- Select the "**TIMER**" to be programmed using the   buttons. Press  to confirm.
- Set the filter pump start time "**ON**" and the pump stop time "**OFF**" using the   buttons. Press  to confirm.

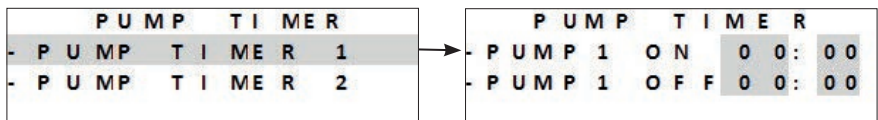

- Press  to exit.
- When the filtration times have been programmed, the letter "**P**" is shown on the screen:

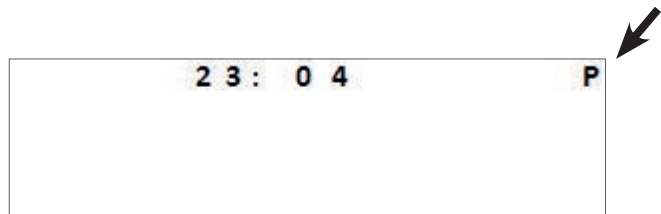







Manual activation of the appliance (by pressing ) has priority over the timer. If no filter pump is connected, the appliance activates chlorination only.

If a single-speed filter pump is connected, it is activated at the same time as chlorination.

If a variable-speed filter pump is connected, it operates at the same time as chlorination at its configured speed RPM 1.

All programmes remain valid and normal operation resumes during the next cycle.

==> Zodiac® variable-speed filter pump (depending on the model)

- The filtration "TIMERS" can be programmed for each available speed.
- Select a speed using the   buttons. Press  to confirm.
- Set the filter pump start time "ON" and the pump stop time "OFF" using the   buttons. Press  to confirm.

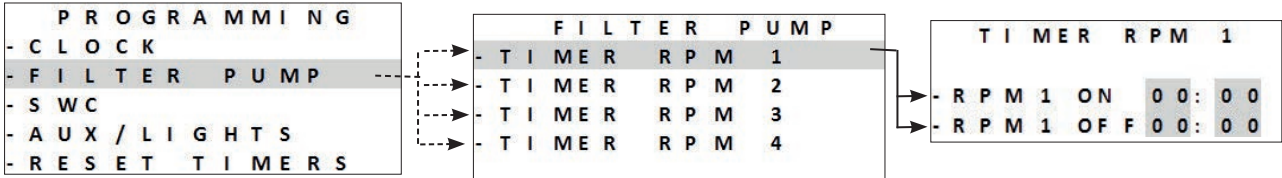

Example programmes (in operation at lower speeds)

- Filtration time (TIMER) in pool season = 12 to 14 hours per day
- Chlorination time (SWC) in pool season = 8 to 10 hours per day
- Filtration time (TIMER) outside of pool season (active winterising) = 3 to 4 hours per day
- Chlorination time (SWC) outside of pool season (active winterising) = 2 to 3 hours per day

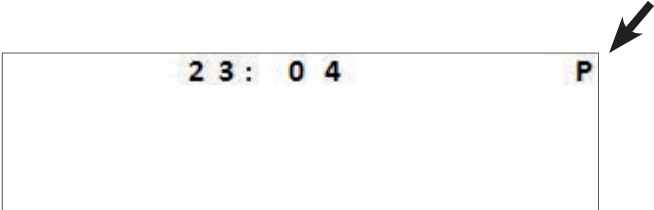

- Press  to exit.
- When the filtration times have been programmed, the letter "P" is shown on the screen:





- Timers 1 and 2 for variable-speed filtration are associated with the appliance's programmes, see "5.2.6 Programming the "SWC" chlorination times".

5.2.6 Programming the "SWC" chlorination times

If a filtration programme has been defined, the chlorination programme will be identical to the filtration programme(s) by default. They can be changed, however the chlorination programmes cannot be activated outside of the filtration programmes for safety reasons.

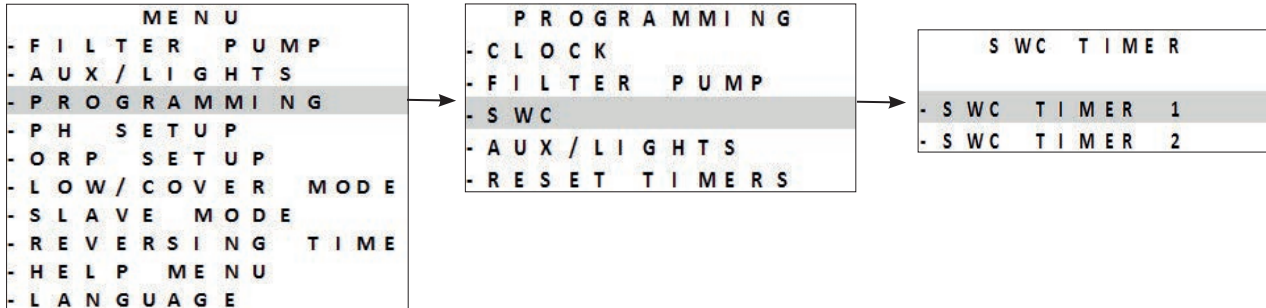
- Press **MENU** and browse using the   buttons. Confirm the selection by pressing **OK**.
- Select "SWC TIMER 1" or "SWC TIMER 2":



- Set the chlorination times "ON" and "OFF" using the   buttons.
- Confirm the selection by pressing **OK**.

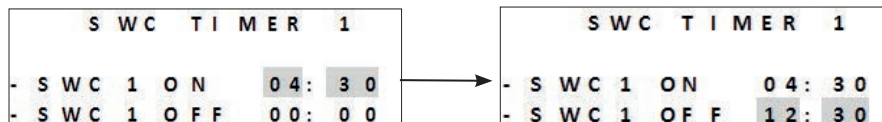

The chlorination duration must be less than or equal to the filtration duration
The appliance does not allow for a time delay for chlorination that exceeds or that falls outside of the programmed filtration duration.

- Press **MENU** to exit.
- When the chlorination times programme has been confirmed, the letter "T" is shown on the screen:

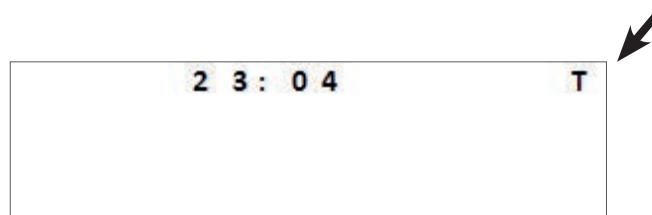

- When the chlorination and filtration times programmes have been confirmed, the letter "P" is shown on the screen:

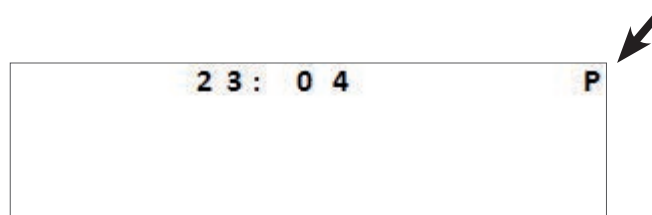

5.2.7 Available auxiliary devices

The appliance is capable of controlling 2 devices in addition to the filter pump. For example, it can control Zodiac® monochrome or polychrome lighting systems. In any case, the equipment must be connected to the appliance using the appropriate auxiliary line:

- **AUX 2** = for equipment powered by the **low voltage supply (12/24 V)**
- **AUX 1** = for equipment powered by the **high voltage supply (230 V) (depending on the model)**



- **Unlike the filter pump, the appliance does not supply power to these two external devices (AUX1 and AUX2). Ensure that these appliances are properly connected to the power supply in accordance with the regulations in force.**

5.2.8 Selecting a lighting system (AUX 2)

- Press **MENU** and browse the menu using the   buttons.

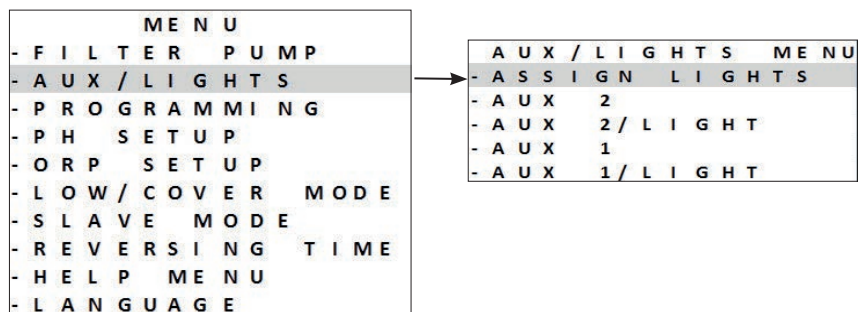

- 2 auxiliary devices can be controlled with the option of assigning one device as a lighting system:

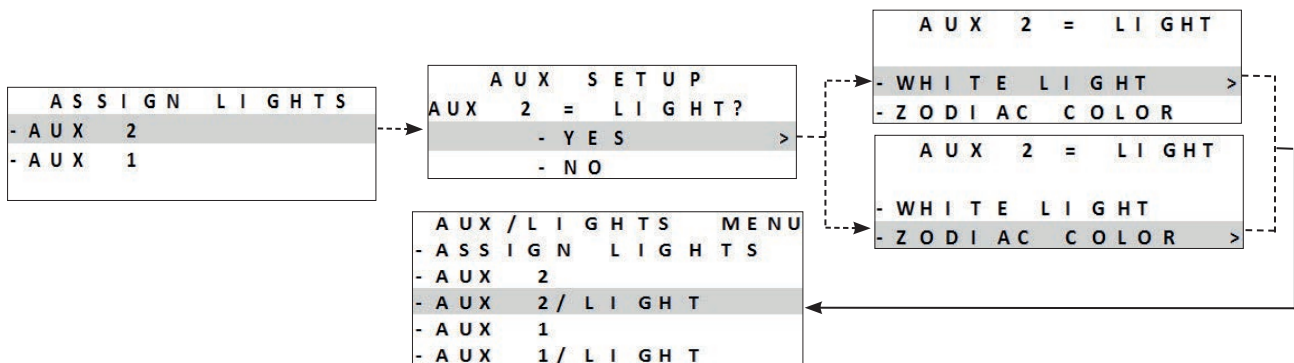

- Press **OK** to confirm.
- Press **MENU** to exit.

==> Monochrome lighting

- Press **MENU** and browse the menu using the **▲** **▼** buttons.
- Select a function and press **OK** to confirm.

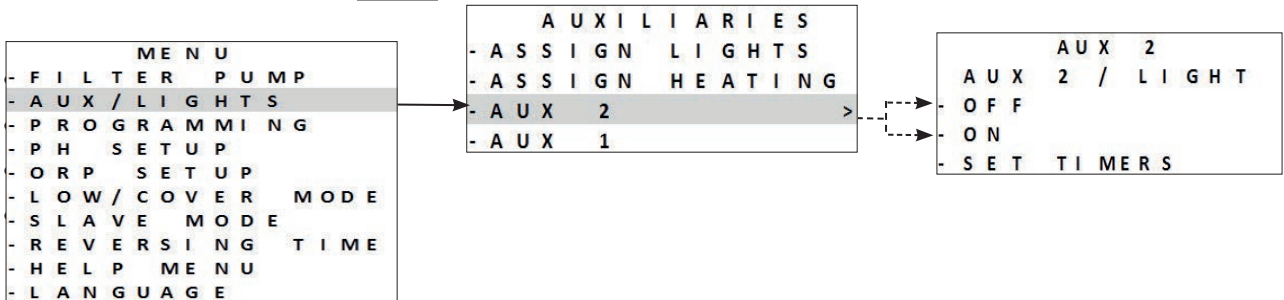

- Press **MENU** to exit.

==> Zodiac® polychrome lighting

- Press **MENU** and browse the menu using the **▲** **▼** buttons.
- Select a function or a colour and press **OK** to confirm.

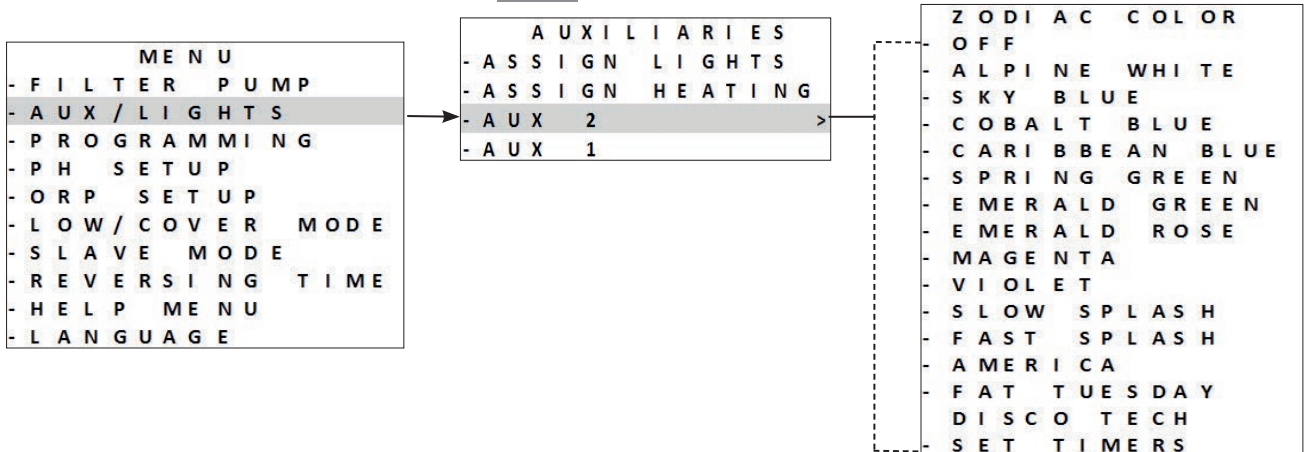

- Press **MENU** to exit.

i Only the "ON/OFF" management function is available for polychrome lighting produced by a different brand.

5.2.9 Declaring a heating system (AUX 2)

- To achieve this, the heating system must have already been connected to the power supply, see “2.5.7 Connecting to a heating system = AUX2 - 12-24V”.
- To declare the presence of a heating system, press **MENU**. Browse the menu using the   buttons. Press **OK** to confirm.

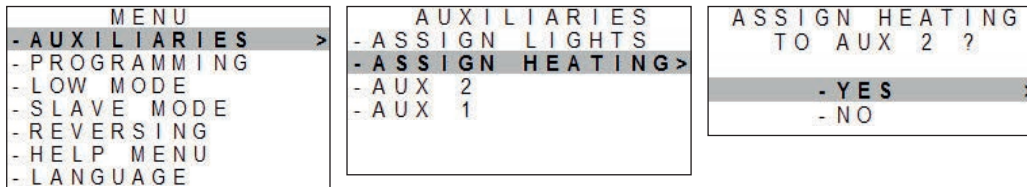

- Once the heating system has been declared, a dedicated sub-menu called "**TEMP CONTROL**" is shown in **MENU**.
- The heating management system is now automatically activated. It can be deactivated, for example for winterising:

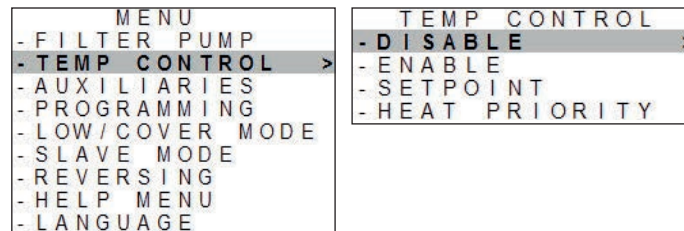

When a heating system has been declared on AUX2, the AUX2 timer is no longer available. Heating will thus take place within the operating periods (timers) of the filtration system.

Configuring the setpoint:



Check that the setpoint has been set to its maximum on the heating system.

Configure the desired water temperature setpoint. The default value is 28°C. **This value can be set between 15 and 32°C.** In this case, the temperature sensor of the chlorinator measures the water temperature.

- Press **MENU**. Browse the menu using the **▲** **▼** buttons. Press **OK** to confirm.

```
MENU
- FILTER PUMP
- TEMP CONTROL >
- AUXILIARIES
- PROGRAMMING
- LOW/COVER MODE
- SLAVE MODE
- REVERSING
- HELP MENU
- LANGUAGE
```

```
TEMP CONTROL
- DISABLE
- ENABLE
- SETPOINT >
- HEAT PRIORITY
```

```
TEMP CONTROL
TEMP. SETPOINT
  28 °C
```

EN

- Depending on the heating system (in particular when using a heat pump), there may be a delay of a few minutes between the time the chlorinator closes the AUX2 contact to activate the heating system and the effective start-up of the heating system (heat pump compressor).
- The chlorinator displays the measured water temperature:

```
25° 00:00 OFF
```

heating stopped

```
25▲ 00:00 OFF
```

heating in operation



The water temperature is measured by the water temperature sensor of the chlorinator:

- If the measured water temperature **falls below the setpoint value by 1°C or more** (e.g. 28°C - 1°C = 27°C), the relay is closed to activate the heating system.
- If the measured water temperature **is equal to or greater than the setpoint value by 1°C or more** (e.g. 28°C + 1°C = 29°C), the relay is opened to deactivate the heating system.

Heating priority (optional):

The "heating priority" function is only displayed if a heating system and a filter pump (single- or variable-speed pump) have been declared in the chlorinator.

- Press **MENU**. Browse the menu using the **▲** **▼** buttons. Press **OK** to confirm.

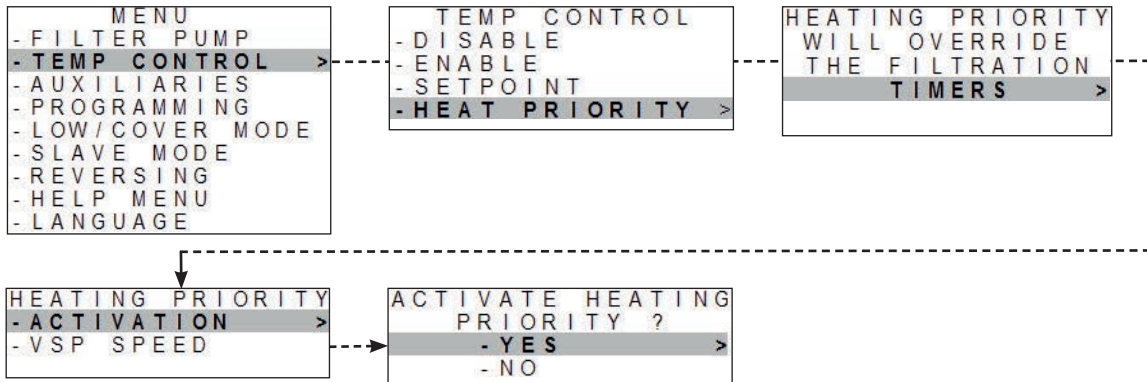

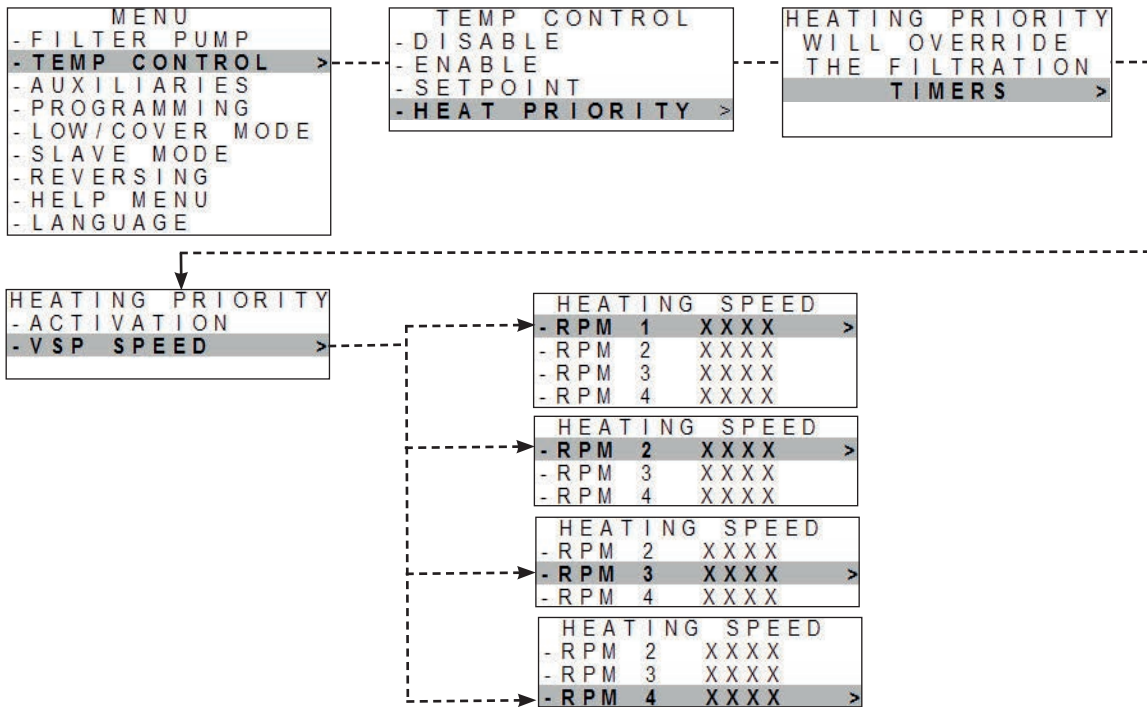

- Select the speed of the pump in "heating priority" mode (if a compatible Zodiac® variable-speed pump has been declared). Use a speed that is less than or equal to the speed normally used for filtration timers:



i - If a filter pump has been declared and the heating priority is activated outside of the filtration timers: filtration will occur for 5 minutes every 120 minutes in order to measure the water temperature.
 - If necessary, the filter pump and the heating system will be activated until the desired water temperature setpoint is reached.

5.2.10 Deleting the programmes

- Press **MENU** and browse the menu using the   buttons.
- Press **OK** to confirm.
- The programmes will be reset to 00:00.

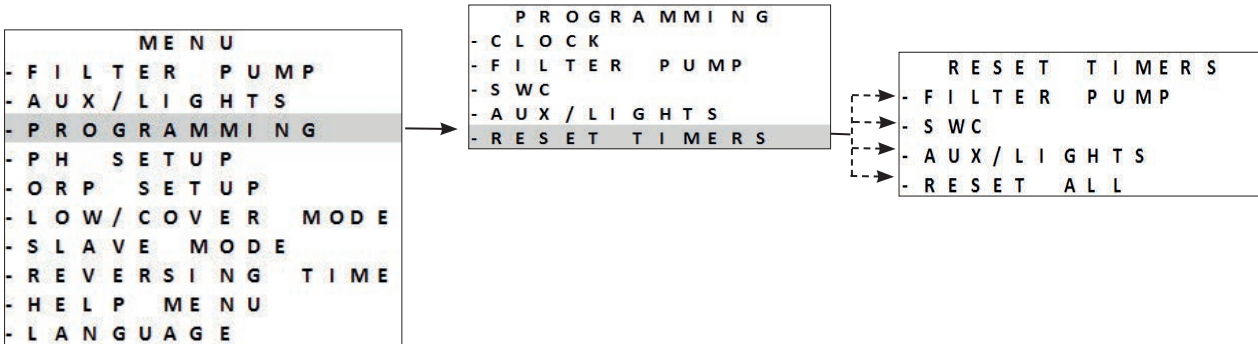

5.2.11 Use with a filtration control panel

In this configuration, the filtration control panel powers the appliance on and off.

 • This connection mode is not recommended since the appliance has its own internal timers.

- In order to be controlled by a filtration control panel, the appliance's programmes must be reset, see "5.2.10 Deleting the programmes", page 39.
- Once connected to the filtration control panel, switch the appliance off and on again.

5.2.12 Slave mode

"Slave" mode transfers control over the chlorination function to an external controller. The external controller must be

connected to the connection point  on the low-voltage circuit, see "2.5 I Electrical connections".

"Boost" and "Low" modes can still be managed by the controller. However, the appliance's programmes are deactivated. Chlorine production is maintained at 100%.

- Connect the external controller to the slave connection point on the low-voltage circuit, see "2.5 I Electrical connections".

- Press **MENU** and browse the menu using the   buttons. Press **OK** to confirm.

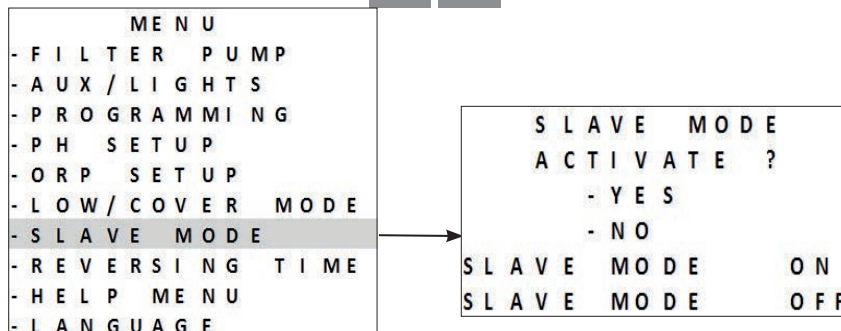

- Press **MENU** to exit.

"Slave" mode only controls chlorination. The filter pump, accessories, lighting and other functions remain valid.

A press of the  key has priority over "Slave" mode.

If a Dual Link module is installed, the ORP function is ignored by the "Slave" mode. pH regulation remains valid.

"LOW"/"COVER"/"BOOST" modes have priority over "Slave" mode.



Slave mode operates as follows: "contact closed = chlorination ON/contact open = chlorination OFF".

5.2.13 Configuring the duration of polarity reversal







The polarity reversal principle eliminates scale that has deposited on the electrodes by reversing the electrical power at a specified time. By default, the cycle is reversed **every 5 hours**.

The hardness of the water varies depending on the geographical region concerned (water hardness = TH).

In order to protect the electrodes from scale build-up (which reduces the efficacy of the electrolysis reaction), the polarity reversal time can be adjusted.

- Before setting the polarity reversal time, analyse the hardness (TH) of the pool water, see **"4.1 I Balancing the water"**.

Water hardness (TH)	Recommended polarity reversal time (hours)
< 15°f (150 mg/L or ppm)	6 - 8
15 - 30 °f (150 - 300 mg/L or ppm)	5
30 - 40 °f (300 - 400 mg/L or ppm)	3 - 4
> 40°f (400 mg/L or ppm)	2 - 3

- Press  and browse the menu using the   buttons. Press  to confirm.
- Select the polarity reversal time (can be set every 2 to 8 hours) using the   buttons. Press  to confirm.

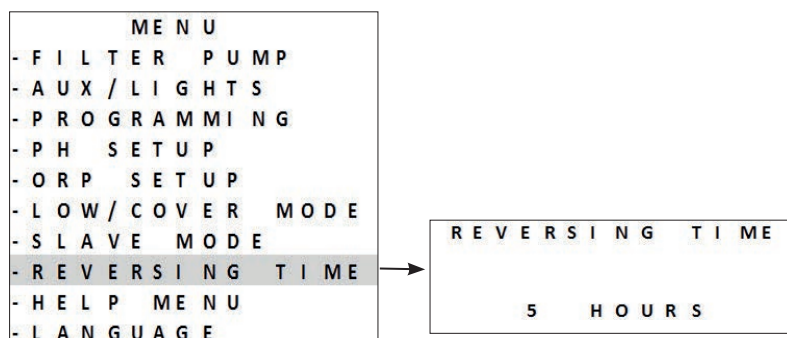

- Press  to exit.



At the time of reversal, chlorination is stopped for a few minutes. No message is displayed on the screen. Normal operation resumes after reversal is complete.

5.3 I Calibrating the sensors (if an optional "pH Link" or "Dual Link" module has been installed)

5.3.1 Calibrating the pH sensor (blue)

The pH sensor can be calibrated to 1 point or 2 points (pH 4 and pH 7). **2-point calibration is recommended to improve measurement accuracy.**

The setpoints are displayed on the home screen when the appliance is switched on.

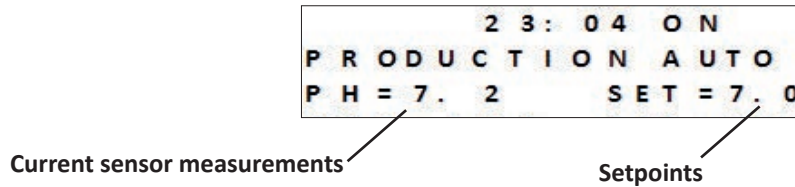

- Switch on the appliance.
- Switch off the pool's pump and close the necessary valves in order to isolate the cell and the sensors.
- Press **MENU** and browse the menu using the **▲** **▼** buttons. Press **OK** to confirm.
- Select 1- or 2-point calibration (2-point calibration is recommended):

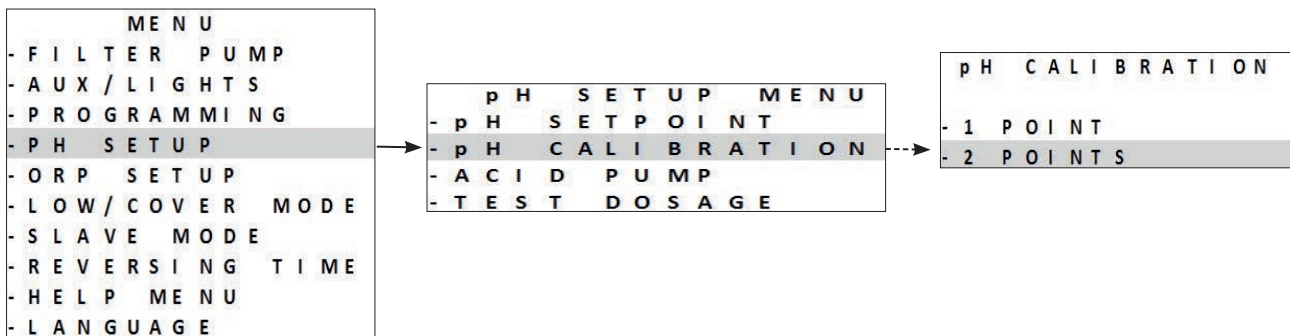

- Unscrew and remove the pH sensor from the POD.
- Rinse the tip of the sensor with tap water.
- Shake it to remove any residual water. Do not touch the glass bulb at the end of the pH sensor.
- Place the pH sensor in the pH 7 solution and follow the on-screen instructions:

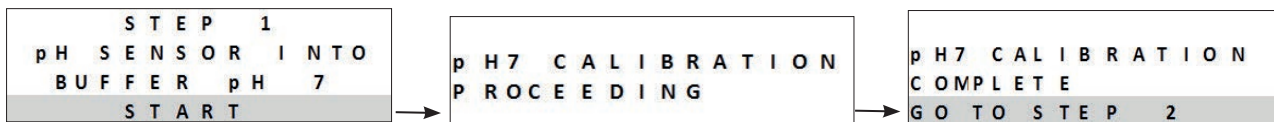

- Rinse the tip of the sensor with tap water.
- Shake it to remove any residual water. Do not touch the glass bulb at the end of the pH sensor.
- Place the pH sensor in the pH 4 solution and follow the on-screen instructions:

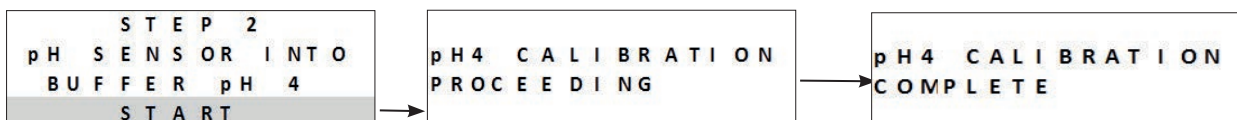

- Once calibration is complete, replace the sensor on the POD.
- If calibration is unsuccessful, see **"8.1 I Appliance behaviour"**.



1-point calibration: possible if the pH 7 and pH 4 solutions provided are no longer available.

In order to do this:

- Use a sample of water with a known pH value.

- Activate 1-point calibration and input this pH value on the screen:

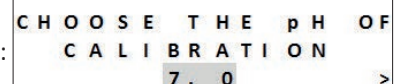

5.3.2 Configuring the pH setpoint

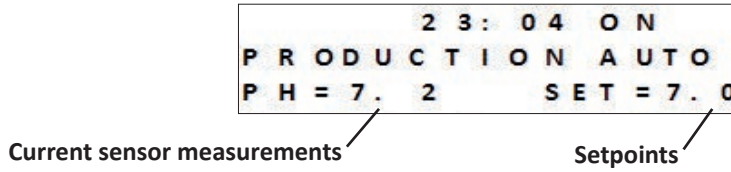

The pH setpoint configuration determines the time when acid is added to the system to reduce the water's pH. **The default value of the pH setpoint is 7.2.**

To determine the value of the setpoint to be configured, refer to Taylor's balance, see **"4.1.3 Weekly analyses"**.

- Press **MENU** and browse the menu using the **▲** **▼** buttons. Press **OK** to confirm.
- Select the desired setpoint value (from 6.8 to 7.6):

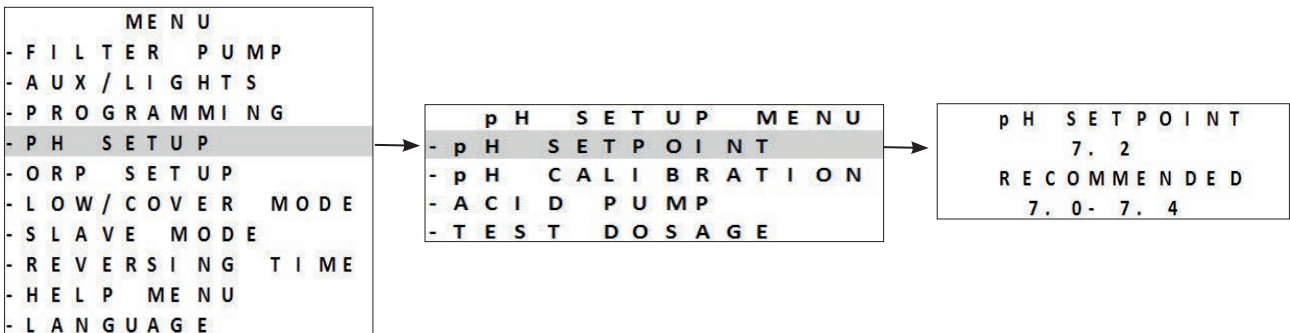

Principle of injecting pH into the appliance:

Example of 4 cycles with a setpoint at 7.4 pH and acid regulation (standard alkalinity):

- **pH ≥ 7.55:** 20% injection (2 min) & 80% pause (8 min)
- **pH ≥ 7.7:** 50% injection (5 min) & 50% pause (5 min)
- **pH ≥ 7.85:** 75% injection (7 min 30 sec) & 25% pause (2 min 30 sec)
- **pH > 7.9:** 100% injection (10 min)

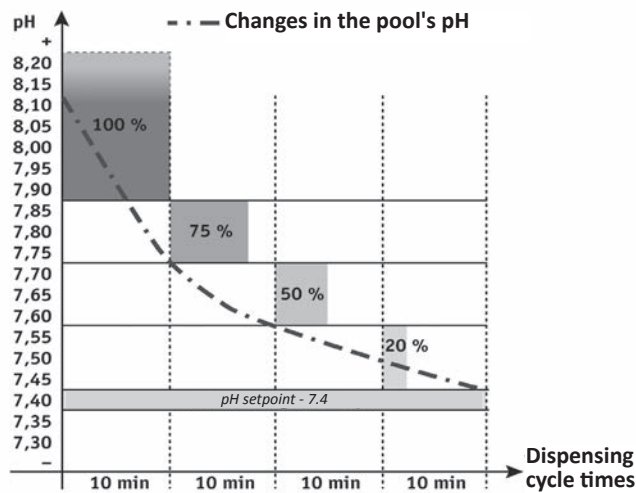

5.3.3 Calibrating the ORP sensor

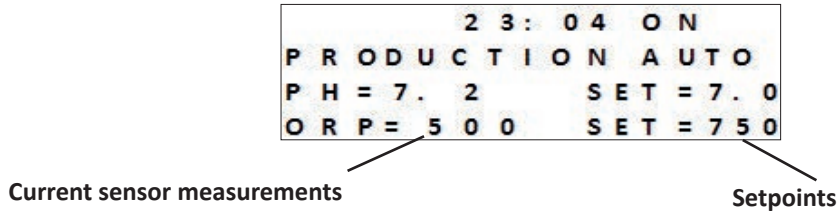

The ORP sensor can be calibrated to 1-point (ORP 470 mV);
 The current setpoint is displayed on the home screen when the appliance is switched on.

- Turn on the power supply to the appliance.
- Switch off the pool's pump and close the necessary valves in order to isolate the cell and the sensors.
- Press **MENU** and browse the menu using the **▲** **▼** buttons. Press **OK** to confirm.

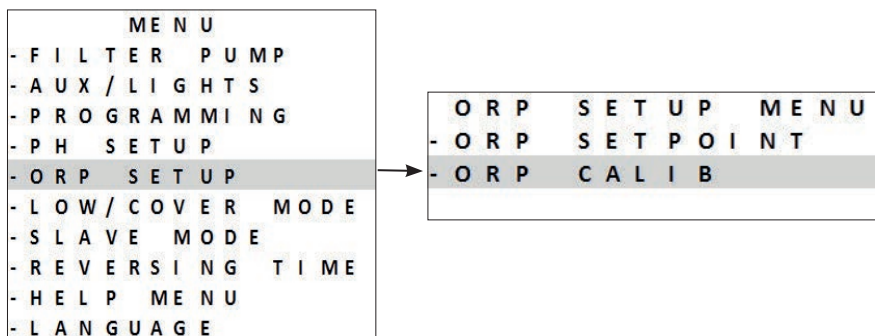

- Unscrew and remove the ORP sensor from the POD.
- Rinse the tip of the sensor with tap water.
- Shake it to remove any residual water. Do not touch the end of the ORP sensor.
- Place the ORP sensor in the ORP 470 mV solution for 1 minutes, and follow the on-screen instructions:

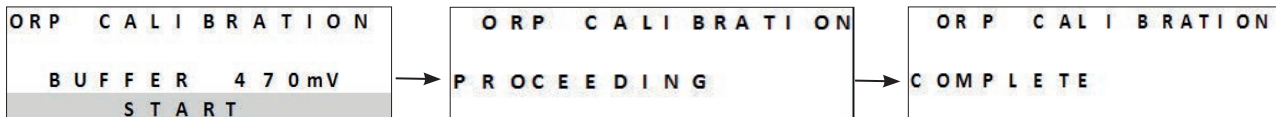

- Once calibration is complete, replace the sensor on the POD.
- Press **MENU** to exit.
- If calibration is unsuccessful, see **"8.1 I Appliance behaviour"**.

5.3.4 Configuring the ORP setpoint

The ORP setpoint configuration determines the time at which chlorine is produced by the appliance. The level of free chlorine must be controlled at regular intervals after initial installation. **The default value of the ORP setpoint is 700 mV.** The value of the setpoint depends on the pool's environment, its affluence, and the amount of stabiliser present in the pool water, etc.

- Press **MENU** and browse the menu using the **↑** **↓** buttons. Press **OK** to confirm.
- Select the desired setpoint value (from 600 mV to 900 mV) using the **↑** **↓** buttons.
- Press **OK** to confirm.

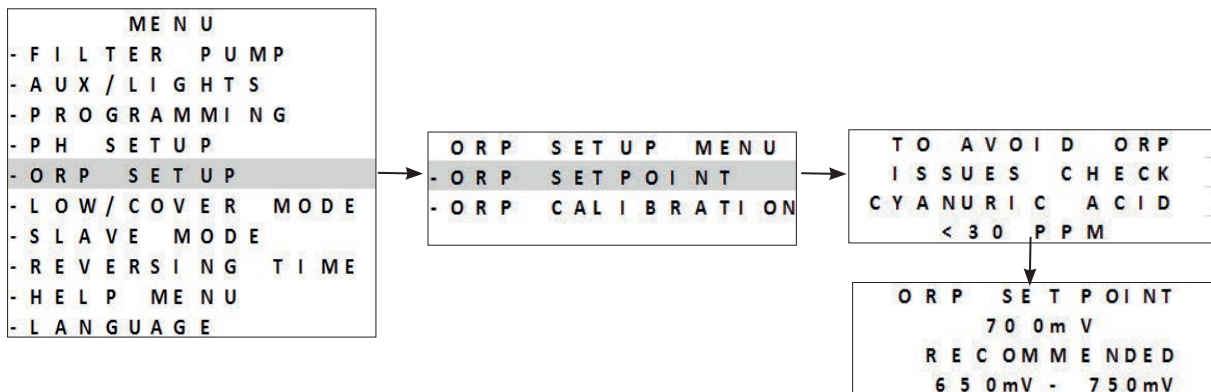

5.3.5 Activating the pH pump

To prevent exposure to acid during installation, the dispenser pump is deactivated for the first 8 hours of operation; during these first 8 hours, the pH value is measured and displayed as " - - - ".



- **Hydrochloric acid is a hazardous chemical that may cause burns, lesions and irritations. Handle with care and use protective equipment (gloves, safety glasses, overalls). Refer to the product's MSDS for more information.**
- Always pour the acid into the water.
- Once cleaning is complete, dispose of the solution according to the standard in force in the country of use.

- The pH pump can be manually activated during this 8-hour period; press **MENU** and browse the menu using the **↑** **↓** buttons. Press **OK** to confirm.

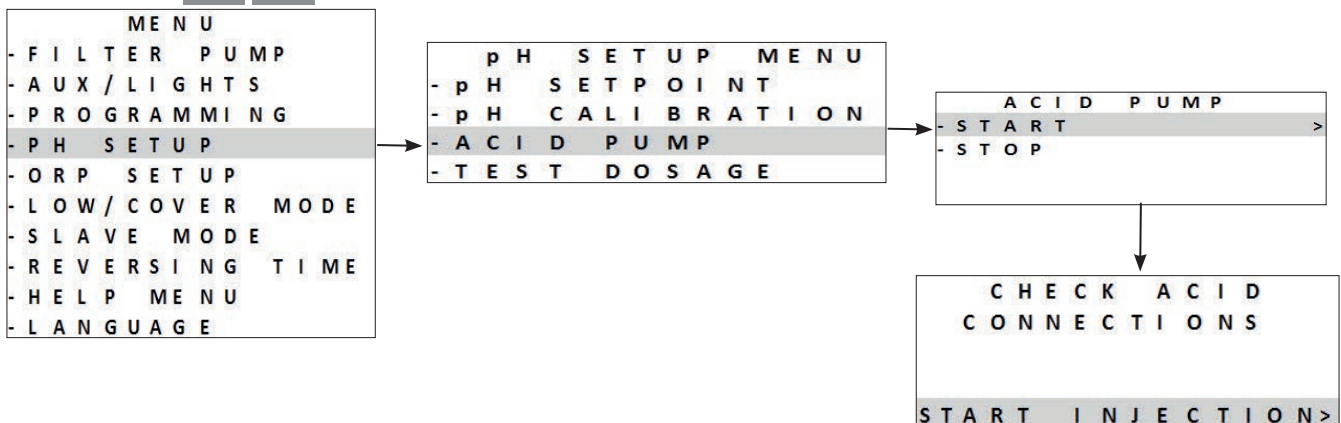

- Press **MENU** to exit.

5.3.6 Pausing the pH pump

To prevent acid from being injected when not needed: The pH dispenser pump can also be stopped for 8 hours.

- Press **MENU** and browse the menu using the **▲** **▼** buttons. Press **OK** to confirm.

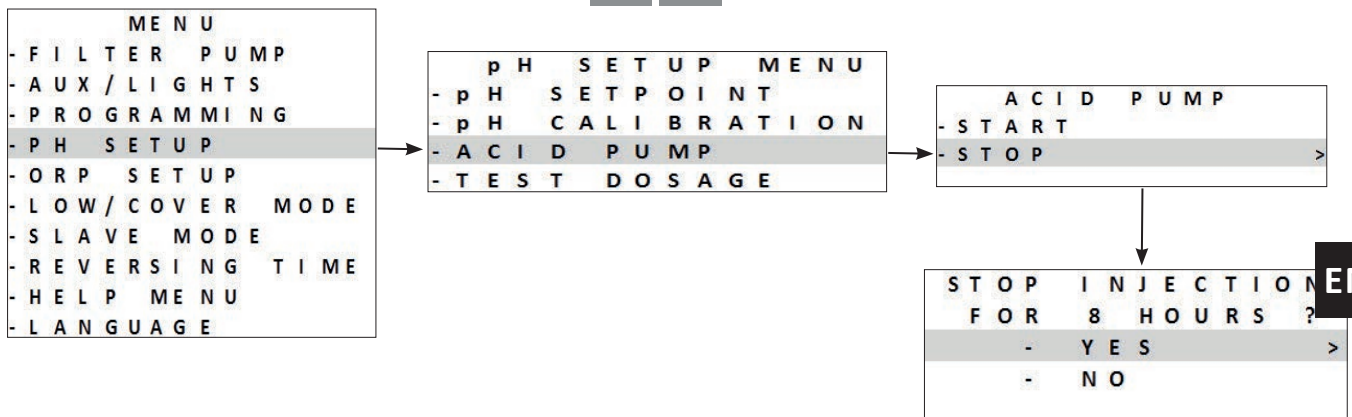

- Press **MENU** to exit.

5.3.7 Testing the pH pump

The pH dispenser pump can be directly activated to perform a 5-minute operating test.

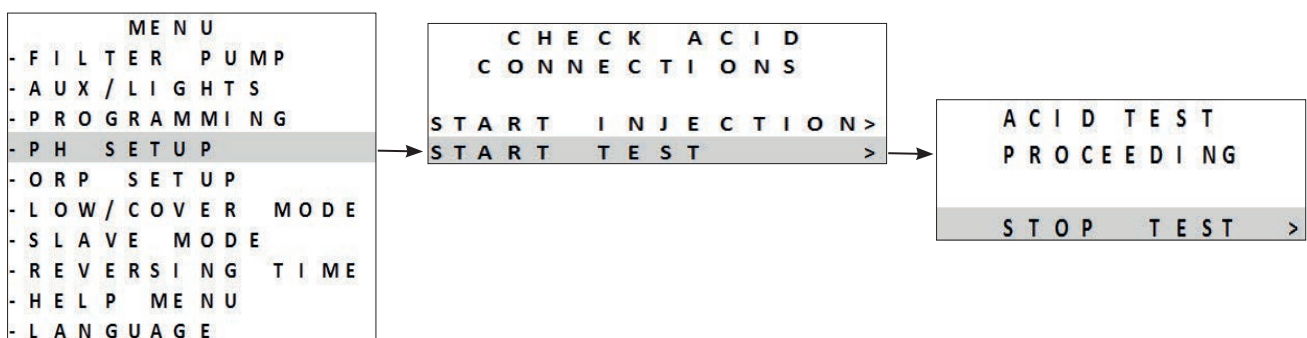

- Press **MENU** and browse the menu using the **▲** **▼** buttons. Press **OK** to confirm.



- The acid pump performs a 5-minute operating test.
- The pump stops automatically once the 5-minute test is complete.
- Press **MENU** to exit.

➤ 5.4 I Routine use

5.4.1 Adjusting chlorine production

The factory setting for "conventional" chlorination is 50%. It can be manually set to between 0 and 100% in intervals of 10% from the "main screen" by pressing  . The setpoint value remains valid until next modified.



"Conventional" chlorination refers to the manual management of chlorine production (outside of "Boost" mode or "Low" mode, and with no connected "ORP" regulation).

5.4.2 "Boost" mode

In some cases, the pool may require a higher than normal chlorine level, for example during times of high use, bad weather or at the start of the pool season. "**Boost**" mode is used to increase the chlorine level quickly.

"**Boost**" mode operates for 24 consecutive hours at a 100% production rate.

If the programme is configured to perform chlorination for 12 hours a day, "**Boost**" mode is activated for 12 hours the first day and for 12 hours the second day.

If the filter pump is connected to the appliance, it also operates in "**Boost**" mode. The chlorination and filtration timers are temporarily ignored throughout the duration of Boost mode.

Once "**Boost**" mode has been deactivated, the appliance and the filter pump resume the programmed operations.



- If the appliance is equipped with a Dual Link module, Boost mode does not take into account the ORP value. "**Boost**" mode has priority over ORP regulation.
- Boost mode can be activated even if the water is too cold (<15°C).

- Press .

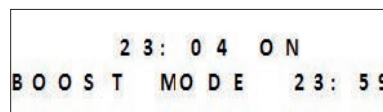

23: 04 ON
B O O S T M O D E 23: 59

Time remaining
for "Boost" mode



- If the appliance is in Low/Cover mode, you must confirm that you want "**Boost**" mode to cancel the settings implemented for "**Cover**" or "**Low**" mode.

5.4.3 "Low" mode

"**Low**" mode is designed to reduce chlorine production when the pool is covered or during periods of low pool use. Chlorine production must be reduced when the pool is not used very often and/or when the pool water is not exposed to UV rays, etc.

Production in "**Low**" mode can be configured in the settings of the main menu from "**Low/Cover**" mode.

"**Low/Cover**" mode can be configured from 0% to 30% in intervals of 10%. The programmes remain active when the appliance is in "**Low/Cover**" mode.

- To manually access "**Low**" mode, press .
- To leave "**Low**" mode, press  again.

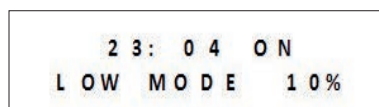

23: 04 ON
L O W M O D E 10%

5.4.4 "Cover" mode

If the pool is equipped with a compatible electric shutter (contact closed = shutter closed), it can be connected to the appliance in order to automatically reduce chlorination when closed. This is known as "**Cover**" mode. Chlorination will resume at the level determined by the programmes on opening the compatible electric shutter.

Production in "**Cover**" mode can be configured in the settings of the main menu from "**Low/Cover**" mode. "**Low/Cover**" mode can be configured from 0% to 30% in intervals of 10%. The programmes remain active when the appliance is in "**Low/Cover**" mode.



Check that the shutter is compatible and is connected to the appliance **COVER** on the low-voltage circuit, see "**2.5 I Electrical connections**".

"**Cover**" mode is automatically activated when the shutter is closed. The message "**Cover**" mode and the production rate are displayed on the screen.

```

      2 3 : 0 4  O N
COVER MODE 10%
  
```

"**Cover**" mode will end as soon as the shutter is completely open.

If the appliance is equipped with a Dual Link module, we recommend not connecting "**Cover**" mode. More specifically, chlorination is managed by the Dual Link module. In cases where "**Cover**" mode is connected in the presence of a Dual Link module, chlorination will be performed when the shutter is closed, even if the ORP measurement is greater than the setpoint value.

5.4.5 "Cold water" safeguard (depending on the model)

In addition to displaying the water temperature, the temperature sensor is used to protect the cell, which is sensitive to cold water (reduced conductivity between the plates and thus an increase in voltage).

The temperature displayed in the top left corner of the home screen starts to flash at 15°C.

```

1 5 ° 2 3 : 0 4  O N
  
```

When the water temperature is less than or equal to 15°C, chlorine production automatically switches to the rate defined in "**Low**"/"**Cover**" mode (between 0 and 30%).



When the water temperature is less than or equal to 10°C, chlorine production stops. The absence of chlorination at this temperature is not an issue since bacterial development is slowed in cold water.



In addition to the flashing temperature display, the message "**LOW TEMPERATURE**" is displayed intermittently.

When the temperature rises to above 10°C, the production rate is set to "**Low**"/"**Cover**"

When the temperature rises to above 15°C, chlorination is resumed at the operating rate set via the programmes.

5.4.6 Locking the interface

The appliance can be locked, which deactivates the buttons on the user interface panel. Press both buttons  and  simultaneously for 3 seconds. This function can be accessed from any screen/menu.

Locking the appliance automatically redirects the user to the home screen. Press both buttons  and  simultaneously for 3 seconds to unlock the appliance.



6 Control using the iAquaLink™ app (depending on the model)

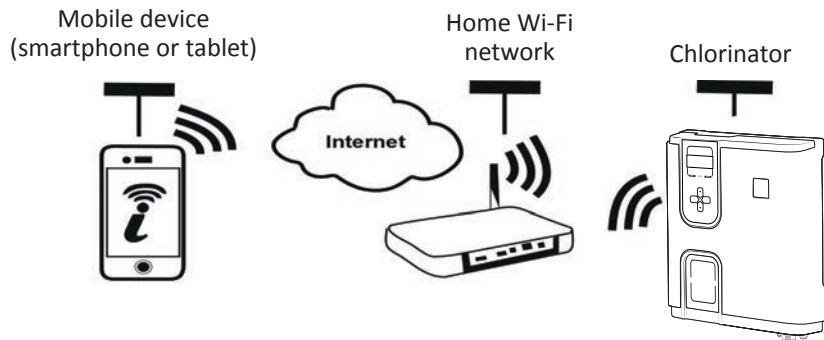

The iAquaLink™ app is available for iOS and Android systems. With the iAquaLink™ app you can control the chlorinator from any location at any time and have the benefit of advanced functions such as additional programming options and troubleshooting assistance.



Before you install the app, you must:

- Use a Wi-Fi-enabled smartphone or tablet,
- Use a smartphone or tablet with iOS 11.0 or later or Android 5.0 or later.
- Use a Wi-Fi network with a reasonably strong signal when connecting to the chlorinator.
- Have your home Wi-Fi network password at the ready.

6.1 I Configuring the appliance before first use

- Download the iAquaLink™ app from the **App Store** or **Google Play Store**.

<p>1</p> <p>Connect to your iAquaLink account or register to create an account (first-time use).</p>	<p>2</p> <p>Add an appliance, select the product and log in.</p>	<p>3</p> <p>Press both buttons until the Wi-Fi LED starts to flash.</p>
<p>4</p> <p>The Wi-Fi LED is flashing (pairing in progress).</p>	<p>5</p> <p>Select the "Chlorinator" network (modem/LAN).</p>	<p>6</p> <p>Choose the home Wi-Fi network and enter the Wi-Fi password.</p>

7



Once the connection with your home network is established, the appliance is connected to the Internet (WEB): the Wi-Fi LED is then lit steady.

EN



- It can take several minutes to connect.
- If an error message appears or if the connection still isn't made, **refer to the table "8.2 I Wi-Fi LED behaviour"**.
- Depending on the case, the appliance may request an update after initial connection. This process can take up to 65 minutes. Leave the chlorinator on standby during this process (chlorination OFF).
- Once configured, the appliance is displayed in **"My Appliances"** when next connecting to the iAquaLink™ application.



7 Care

7.1 I Cleaning the sensors

The sensors must be cleaned every 2 months.

- Stop the filter pump.
- Close all valves.
- Remove the sensor and the sensor holder from the POD.
- Rinse the sensor in tap water for 1 minute.
- Shake it to remove any residual water.



To prevent damage to the active part, do not rub and do not dry with a cloth.

- Brush the junctions and the metal part (Gold) for the ORP sensor using a toothbrush for 1 minute.



- Prepare a solution of diluted hydrochloric acid by pouring 1 mL (10 drops) of commercially-available hydrochloric acid (HCl 37 %) into 50 mL of tap water (1/2 glass of water).



- **Hydrochloric acid is a hazardous chemical that may cause burns, lesions and irritations. Handle with care and use protective equipment (gloves, safety glasses, overalls). Refer to the product's MSDS for more information.**
- **Always pour the acid into the water.**
- **Once cleaning is complete, dispose of the solution according to the standard in force in the country of use.**

- Wash the sensor in the diluted hydrochloric acid solution for 2 minutes.
- Rinse the sensor in clean water under the tap for 1 minute.
- Shake it to remove any residual water.
- Then calibrate the sensor, see “**5.3 I Calibrating the sensors (if an optional “pH Link” or “Dual Link” module has been installed)**”.
- Reposition the sensor holder and the sensor on the POD kit.

7.2 I Inspecting and cleaning the electrodes



The appliance is equipped with a smart polarity reversal system designed to prevent the electrode plates from scaling. The polarity reversal duration can be modified, see “5.2.13 Configuring the duration of polarity reversal”. However cleaning may be required in regions where the water is very hard.

- Turn off the appliance and the filtration system, close the isolation valves, remove the protection cover and disconnect the cell power cable.

==> eXO®(iQ) cell:

- Unscrew the compression ring and remove the cell, **see figure 1**. The ring is crenelated thus allowing a lever to be used in the event of it jamming. Submerge the part containing the electrode plates in a suitable recipient containing the cleaning solution.

==> GenSalt OT cell:

- Position the cell upside down and fill it with a cleaning solution such that the electrode plates are submerged.

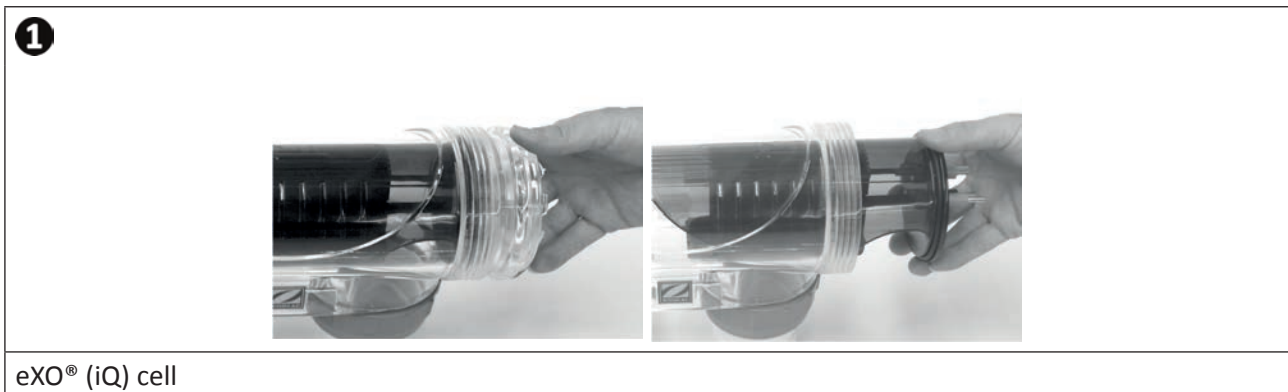

- Leave the cleaning solution to dissolve the scale deposit for about 15 minutes. Dispose of the cleaning solution at an approved waste recycling site. Never pour into the rainwater drainage system or into the sewers.
- Rinse the electrode using clean water and put it back on the cell fixture collar (there is a foolproofing key to ensure correct alignment).
- Refit the tightening ring, reconnect the cell cable and refit the protective cover.
- Re-open the isolation valves and restart the filtering system and appliance.



If you are not using a commercially-available cleaning solution, you can make your own by carefully mixing 1 part hydrochloric acid with 9 parts water. (Caution: always pour the acid into the water and not the opposite and wear suitable protective equipment!).

7.3 I Washing the pool filter (backwashing) (depending on the model)

Backwash mode is used to quickly start/stop the filter pump (single-speed pump or variable-speed pump) in order to backwash the filter.

- Press **MENU** and browse the menu using the **▲** **▼** buttons. Press **OK** to confirm.
- Select **ON** to activate filtration or **OFF** to stop filtration.

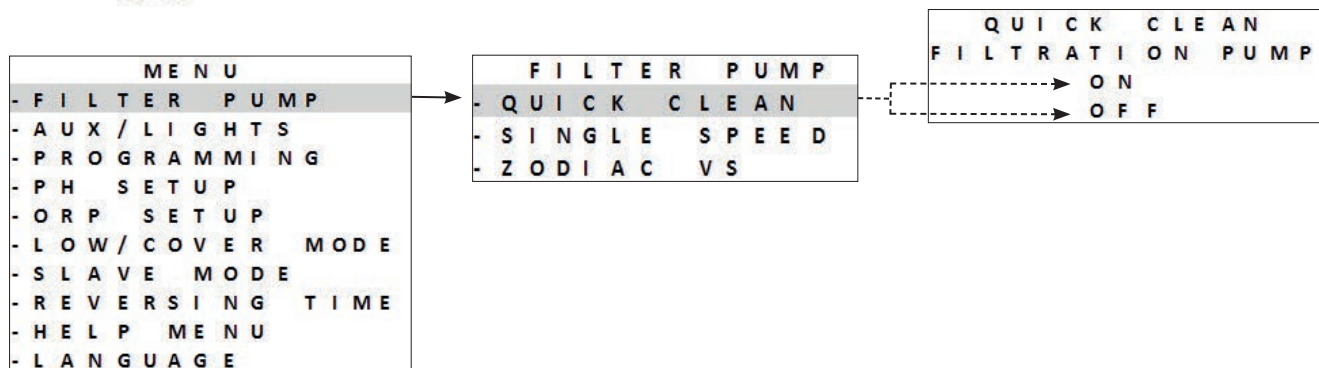

For safety reasons, chlorination stops when in Backwash mode. To prevent the pool from emptying, Backwash mode automatically stops after 5 minutes. The default speed setting for the variable-speed pump is 3,450 rpm (maximum speed). This value can be changed from the priming menu.

7.4 I Winterising



The appliance is fitted with a protection system limiting chlorine production in poor operating conditions such as cold water (winter) or low salt.

- **Active winterising** = filtering operational in winter: below 10°C it is preferable to switch off the appliance. Above this temperature you can leave it running.
- **Passive winterising** = lower water level and drained piping: switch off the appliance and leave the cell dry in place with any isolation valves open.
- **Winterising the sensors** = Keep the plastic sensor tube (which contains a storage solution) for re-use when winterising. The sensors must always be stored wet (never dry). They must be stored in the tube filled with a storage solution of 3 mol/L KCl or at least in tap water.

7.5 I Preparing the pool for re-use

Required actions:

- Adjust the water level (too much or too little).
- Check the water parameters: TA/TH/pH/Salinity/Chlorine/Stabiliser/Copper/Metals, and adjust the parameters to obtain a balanced, healthy pool, see **“4.1 I Balancing the water”**.
- Check the condition of the equipment (pump, filter, chlorinator, electrolytic cell).
- Inspect the sensors, then clean and recalibrate.
- As soon as the salt level reaches the required level of 4,000 ppm and has completely dissolved in the water, restart the salt water chlorinator.



8 Troubleshooting





- Before you contact your retailer, please carry out these few simple checks using the following tables if a problem occurs.
- If the problem continues, contact your retailer.
- : Actions to be performed by a qualified technician only

8.1 I Appliance behaviour

EN





Information messages can be deleted by pressing  for 4 seconds. Some messages require human intervention and cannot be deleted.



8.1.1 Appliance WITHOUT pH Link module or Dual Link module

Message	Possible cause	Solution
"NO FLOW" "CHECK PUMP" ("INFO" indicator lit during the production timers)	<ul style="list-style-type: none"> • Filter pump failure. • The filter and/or skimmer(s) are dirty. • By-pass valve(s) closed. • Disconnection or failure of the flow switch. 	<ul style="list-style-type: none"> • Check the pump, the filter, the skimmer(s) and the by-pass valve(s). Clean them if necessary. • Check the wire connections (flow switch). • Check that the flow switch is working correctly (replace it if necessary: contact the retailer) 
"PROD. ERROR" ("INFO" indicator flashing)	<ul style="list-style-type: none"> • Poor connection of the power supply cord from the cell to the cell or inside the appliance. • The cell plates are worn, scaled up or broken. • Internal electronic problem in the control box following an external electric incident. 	<ul style="list-style-type: none"> • Switch off the appliance ( button) and switch off the power supply to the control box, then check the connections for all cables (mains power supply, cell, etc.). • Replace the cell. • Check the power supply board: contact your retailer) 
"CONDUCTIVITY" ("SALTS" indicator lit)	<ul style="list-style-type: none"> • For models with a temperature sensor, this error can be caused by low water conductivity (low salt). If no temperature sensor is present: this error may be caused by a low water temperature or a low salt level. • Low salt due to water loss or dilution (filter backwash, water renewal, rain, leaks, etc.). • Can vary depending on the temperature and age of the cell. The voltage across the cell terminals varies in time. • The cell is worn, scaled up or broken. 	<ul style="list-style-type: none"> • Check the water temperature. • Check the condition of the cell plates. • Measure the salt concentration in the pool water using a salt tester or a test strip, then add salt to the pool to keep the level at 4 g/L or 2 g/L depending on the model. If you do not know the salt level or how to test it, contact your retailer.
"OVERHEATING" ("INFO" indicator lit)	<ul style="list-style-type: none"> • The temperature inside the control box is too high, chlorination slows (>85 °C) then stops (> 90 °C) if the temperature does not fall back down in order to protect the electric circuits. 	<ul style="list-style-type: none"> • If the box is installed outdoors, protect it from direct sunlight. • Chlorination resumes automatically once the temperature has fallen back down. • Problem on the appliance.
"LOW WATER TEMP." ("INFO" indicator lit, the temperature displayed on the screen flashes).	<ul style="list-style-type: none"> • The water temperature measured by the appliance's temperature sensor is less than or equal to 10°C; production stops in order to protect the cell. 	<ul style="list-style-type: none"> • Chlorination will automatically resume at the Low mode chlorination rate between 10 and 15°C. • Chlorination will automatically resume at the normal chlorination rate when the temperature exceeds 15°C.

Message	Possible cause	Solution
(NO MESSAGE) No visible chlorine production on the cell plates.	<ul style="list-style-type: none"> Chlorination is in the reversal period. Chlorination is set to less than 100% and is stopped. 	<ul style="list-style-type: none"> Wait and see. Chlorination should resume within the next 10 minutes.
(NO MESSAGE) Data loss (time, etc.)	<ul style="list-style-type: none"> Dead battery Power cut 	<ul style="list-style-type: none"> Do not reprogram the following information: time, language, appliance type. Contact your retailer  to replace the 3V CR1220 battery. Wait for the power to be restored. <p>==> The appliance should automatically recover the information saved before the power cut.</p>



8.1.2 Appliance WITH pH Link or Dual Link module



Message	Possible cause	Solution
"pH LOW" ("INFO" indicator lit)	<ul style="list-style-type: none"> The pH is less than 5. Faulty connection or calibration error, pH sensor failure or dirty. Low alkalinity, reduced pH. 	<ul style="list-style-type: none"> Check the pH sensor wiring on the control box and on the sensor holder. Check the operation of the sensor using a sensor tester (contact your retailer) . Clean and calibrate the sensor. Check and adjust the alkalinity. Replace the sensor.
"pH REGUL. STOP" ("INFO" indicator flashing)	<ul style="list-style-type: none"> The pH setpoint has not been reached after 5 consecutive hours of injection. Faulty connection or calibration error, pH sensor failure or dirty. The pH minus container is empty. The peristaltic pump is not primed. High alkalinity, injection of acid does not reduce the pH. 	<ul style="list-style-type: none"> Check the pool's pH using a photometer or a test strip. Check the pH sensor wiring on the control box and on the sensor holder. Check the operation of the sensor using a sensor tester (contact your retailer) . Clean and calibrate the sensor. Replace the pH container. Test the peristaltic pump (contact your retailer) . Reduce the alkalinity level (contact your retailer) . Replace the pH sensor.
"ORP PROD. STOP" ("INFO" indicator flashing)	<ul style="list-style-type: none"> The ORP setpoint has not been reached after 36 consecutive hours of chlorination. Faulty connection or calibration error, ORP sensor failure or dirty. A too high concentration of cyanuric acid significantly reduces the efficacy of the chlorine. A too high concentration of cyanuric acid reduces the ORP measurement taken by the sensor. pH too high. If the total chlorine concentration is too high, the chloramines reduce the ORP measurement taken by the sensor. The appliance is not appropriate for the size of the pool. When the cell is worn, scaled up or defective, the electrolysis reaction does not occur correctly. 	<ul style="list-style-type: none"> Check the pool's chlorine level using a photometer or a test strip. Check the ORP sensor wiring on the control box and on the sensor holder. Check the operation of the sensor using a sensor tester (contact your retailer) . Clean and calibrate the sensor. Empty the pool using the bottom drain to reduce the concentration of cyanuric acid. Perform shock chlorination (with calcium hypochlorite) to reduce the concentration of chloramines. Check the condition of the cells. Replace the ORP sensor.

Message	Possible cause	Solution
"---" displayed where the ORP value should be	<p>Example display:</p> <pre> 2 3 : 0 4 O N P R O D U C T I O N A U T O P H = 7 . 2 S E T = 7 . 0 O R P = - - - S E T = 7 5 0 </pre> <ul style="list-style-type: none"> The pH value measured is greater than 12. The sensor has been automatically blocked by the pH overdose safeguard. 	<ul style="list-style-type: none"> Check the connection between the sensor and the control box, re-connect if necessary (contact your retailer) . While waiting for a replacement sensor, deactivate the ORP function in the service menu in order to switch to manual operating mode (contact your retailer) .
"pH dosing STOP" ("INFO" indicator flashing)	<ul style="list-style-type: none"> The pH value measured remains higher than the pH setpoint despite an injection cycle customised by the pH overdose safeguard. 	<ul style="list-style-type: none"> Check or replace the container. Check and adjust the alkalinity (TA) of the pool water. Check/clean or replace the pH sensor.

 **Tip: if you require assistance, inform your retailer about the appliance's condition to save time**

8.2 I Wi-Fi LED behaviour

Control box status	Meaning
<ul style="list-style-type: none"> The  LED is off 	<ul style="list-style-type: none"> Appliance not connected or Wi-Fi network issue (modem malfunction, changed network name or password, etc.) Repeat the pairing process. If the LED is still not lit despite the pairing attempt, disconnect the reconnect the appliance to the mains power supply.
<ul style="list-style-type: none"> The  LED is flashing 	<ul style="list-style-type: none"> Pairing in progress. To stop pairing, disconnect the appliance from the power supply.
<ul style="list-style-type: none"> The  LED is on steady 	<ul style="list-style-type: none"> Appliance connected to the Wi-Fi network and accessible via the app.

 Pairing can be restarted regardless of the connection status by simultaneously pressing  +  for 4 seconds.

8.3 I Effects of the stabilising agent on chlorine and ORP

A pool ideally has a stabiliser level of 30 ppm and a pH of 7.4.

1 ppm of free chlorine = 700 mV

The user can therefore adjust the chlorination requirements to 700 mV to maintain a level of 1 ppm in the pool. If the level of stabiliser rises to 90 ppm, the ORP value will be incorrect.

1 ppm of free chlorine = 500 mV

If the user keeps the setpoint at 700 mV, a chlorine concentration of 5 ppm will eventually be obtained!

Variations in the ORP measurement depending on the stabiliser concentration (pH 7.4, 25°C)*.

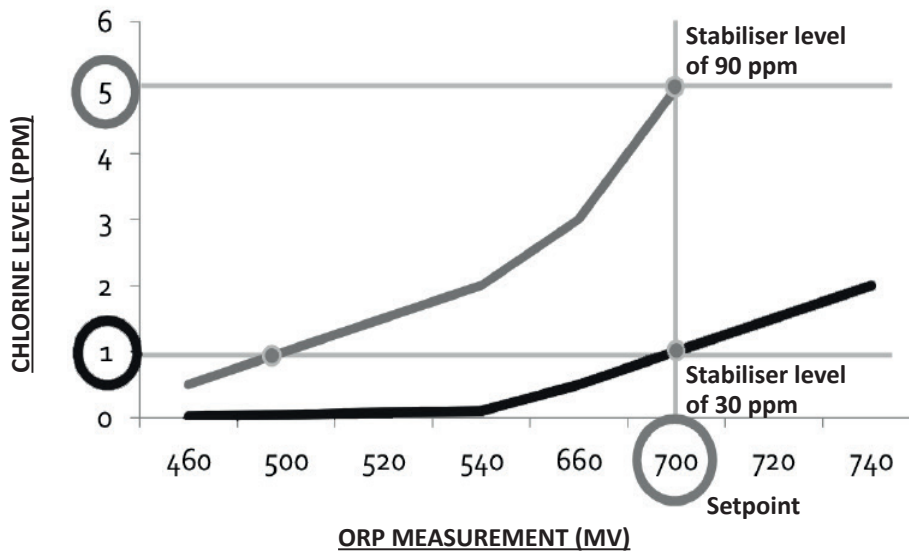

* Theoretical values for information purposes only. Real values may vary slightly depending on the type of water in the pool.

8.4 I HELP menu

The appliance automatically reports any problems by way of information messages. To make these messages easier to understand, the appliance has a troubleshooting menu which gives the meanings and the actions to be taken to resolve the problem.

- Press **MENU** and browse the menu using the **▲** **▼** buttons. Press **OK** to confirm.
- Select the error message using the **▲** **▼** buttons. Press **OK** to confirm.

M E N U	
-	F I L T E R P U M P
-	A U X / L I G H T S
-	P R O G R A M M I N G
-	P H S E T U P
-	O R P S E T U P
-	L O W / C O V E R M O D E
-	S L A V E M O D E
-	R E V E R S I N G T I M E
-	H E L P M E N U
-	L A N G U A G E

- The screen automatically scans a certain number of proposed solutions in order to provide explanations. Once automatic scanning is complete, the appliance automatically returns to the troubleshooting menu.
- Press **MENU** to exit.

Votre revendeur
Your retailer

Modèle appareil
Appliance model

Numéro de série
Serial number

Pour plus d'informations, enregistrement produit et support client :
For more information, product registration and customer support:

www.zodiac.com

