



# Proyector LumiPlus Design

El proyector LumiPlus Design es un proyector subacuático de alta potencia que se puede instalar en nichos de 180mm de diámetro. El embellecedor está disponible en acabado Inox effect y Pure White. La luz puede ser blanca fría, blanca cálida y multicolor RGB. Las versiones multicolor son compatibles con los controles ECO, TOP, Wireless, LumiPlus LED App, ModBUS (Connect) y DMX (consultar códigos).









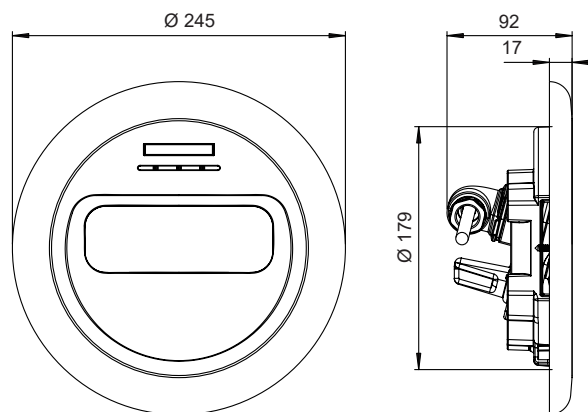



## CARACTERÍSTICAS TÉCNICAS

VOLTAJE:	12V AC
FRECUENCIA:	50/60Hz
VIDA ÚTIL:	L70-50.000h
TEMPERATURA MÁX. AGUA:	40°C
PROFUNDIDAD MÁX. INSTALACIÓN:	2m.
VALORES MÁXIMOS DE TRATAMIENTO DEL AGUA:	Cloro: 2 mg/l Bromo: 5 mg/l Electrólisis de sal (Na Cl): 6 g/l El Ph del agua de la piscina: 7,2 y 7,6
CABLE:	2,5m. H07RN-F 2x1,5mm <sup>2</sup>
MATERIALES:	Cuerpo PPS y PA Embellecedor ABS + IMD
ACCESORIOS Y NICHOS COMPATIBLES:	59813, 59814, 59815, 59818 *

\* Compatible con la mayoría de nichos de Ø180 a 190 mm del mercado (Hugo Lahme, MTS Productks, Wibre...) consultar.



\*medidas en mm.

	59801	59803	59805	59805WW	59807	59807WW	59809	59811
ACABADO EMBELLECEDOR	Inox effect	Pure white	Inox effect	Inox effect	Pure white	Pure white	Inox effect	Pure white
TIPO DE LUZ	RGB 	RGB 	BLANCA	BLANCA CÁLIDA	BLANCA	BLANCA CÁLIDA	RGB DMX	RGB DMX
POTENCIA	32 W	32 W	32 W	32 W	32 W	32 W	32 W	32 W
CONSUMO	42 VA	42 VA	35 VA	35 VA	35 VA	35 VA	42 VA	42 VA
FLUJO LUMINOSO	2.544 lm	2.544 lm	4.320 lm	4.320 lm	4.320 lm	4.320 lm	2.544 lm	2.544 lm
VOLTAJE	12V AC	12V AC	12V AC	12V AC	12V AC	12V AC	12V AC	12V AC
TEMP. DE COLOR	-	-	5.700K	3.000K	5.700K	3.000K	-	-
CRI >	-	-	70	80	70	80	-	-
EFICIENCIA LUMINOSA	80	80	135	135	135	135	80	80
ÁNGULO DE FLUJO	120°	120°	120°	120°	120°	120°	120°	120°
ÓPTICA	Asimétrica	Asimétrica	Asimétrica	Asimétrica	Asimétrica	Asimétrica	Asimétrica	Asimétrica
PROTECCIÓN TÉRMICA	Intermitencia	Intermitencia	Intermitencia	Intermitencia	Intermitencia	Intermitencia	Intermitencia	Intermitencia
CLASE ENERGÉTICA Según UE 2019/2015								
INSTALACIÓN EN AGUA SALADA	Si	Si	Si	Si	Si	Si	Si	Si
SISTEMAS DE CONTROL COMPATIBLES	32458, 27818, 41988, 59131, 57434	32458, 27818, 41988, 59131, 57434	ON/OFF	ON/OFF	ON/OFF	ON/OFF	41107, 74099, 74100	41107, 74099, 74100

## FOTOMETRÍAS

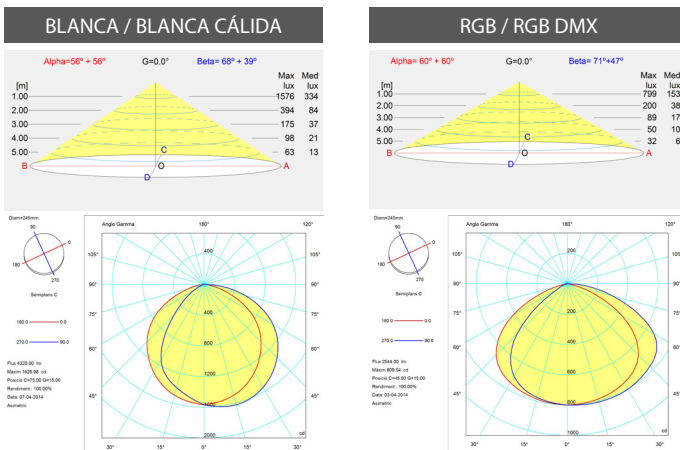
 Fluidra Connect Compatible

## EMBALAJE Y PALETIZADO

Volumen / Caja unitaria (m <sup>3</sup> )	0,004
Peso / Caja unitaria (Kg)	1,350
Unidades / Caja standard	4
Volumen / Caja standard (m <sup>3</sup> )	0,047
Peso / Caja standard (Kg)	5,895
Unidades / Palet	144
Volumen / Palet (m <sup>3</sup> )	2,160
Peso / Palet (Kg)	227,22

CAJA UNITARIA

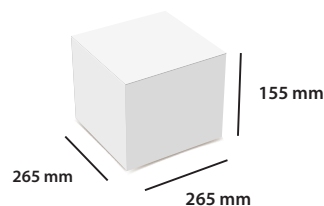

CAJA MÚLTIPLE

