

OPTIMA PLUS

INSTALLATION MANUAL

EN

HANDBUCH

DE

MANUAL DE INSTALACION

ES

MANUEL D'INSTALLATION

FR

MANUALE D'INSTALLAZIONE

IT











MANUAL DE INSTALAÇÃO

PT

OPTIMA PLUS

Control Panel



	Access to the programming menu
	When pressed during the pump operation phase, it cyclically displays the programmed values on the display; When pressed at the same time as the   a keys, it increases or lowers a value dependent on the selected operating mode. During programming it carries out an “enter” function, meaning that it confirms entry to the various menu levels and modifications within the same.
	Starts and stops the pump. In the event of a level alarm (alarm function only), flow alarm, active memory alarm and watchdog com alarm it deactivates the signal on the display.
	Used to “exit” the various menu levels. Before definitively exiting the programming phase, you will be asked if you wish to save any changes.
	Access to the pump calibration menu. If in Off mode, the calibration menu is not activated.
	Used to run upwards through the menu or increase the numerical values to be changed. Can be used to start dosage in Batch mode.
	Used to run downwards through the menu, or decrease the numerical values to be changed.
	Flashing green LED during dosage
	Red LED that lights up in various alarm situations

Electrical connections

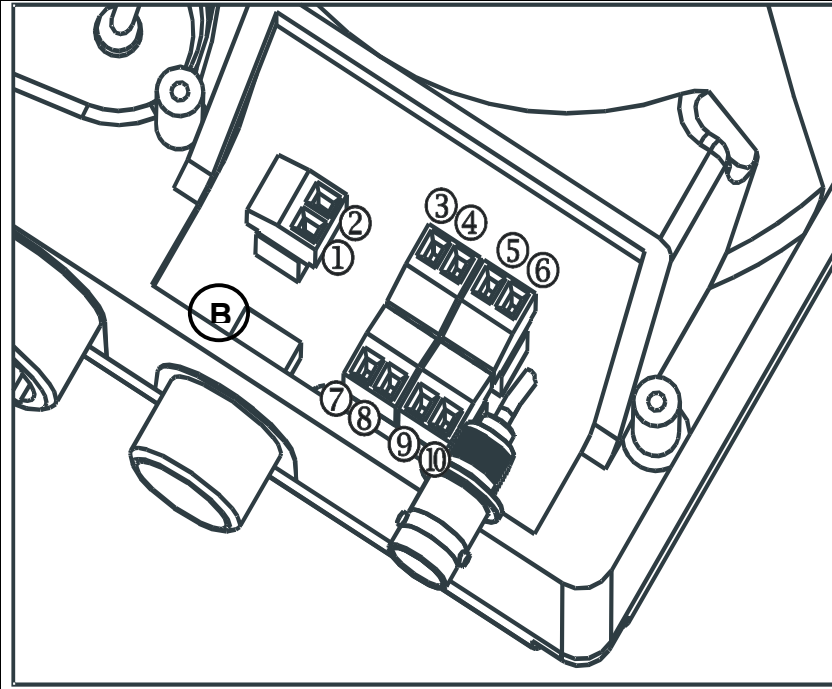



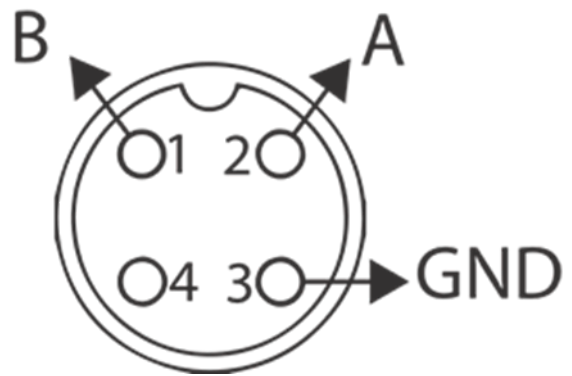

1	Alarm relay	
2		
3	Pole +	4-20 mA Output max 500ohm
4	Pole -	
5	Remote control input (start-stop)	
6		
7	Temperature probe input	
8		
9	Flow sensor input	
10		
B	Input level control	

ModBus connetion	
Pin N°	Description
1	T+R+
2	T-R-
3	GND
4	Not used



OPTIMA PLUS Programming Menu

You can access the programming menu by pressing the  key for over three seconds. The   keys can be used to run through the menu items, with the  key being used to access changes. The pump is programmed in constant mode in the factory. The pump automatically returns to the operating mode after 1 minute of no activity. Any data entered in these circumstances will not be saved.

The  key can be used to exit the various programming levels. Upon exiting programming, the display will show:

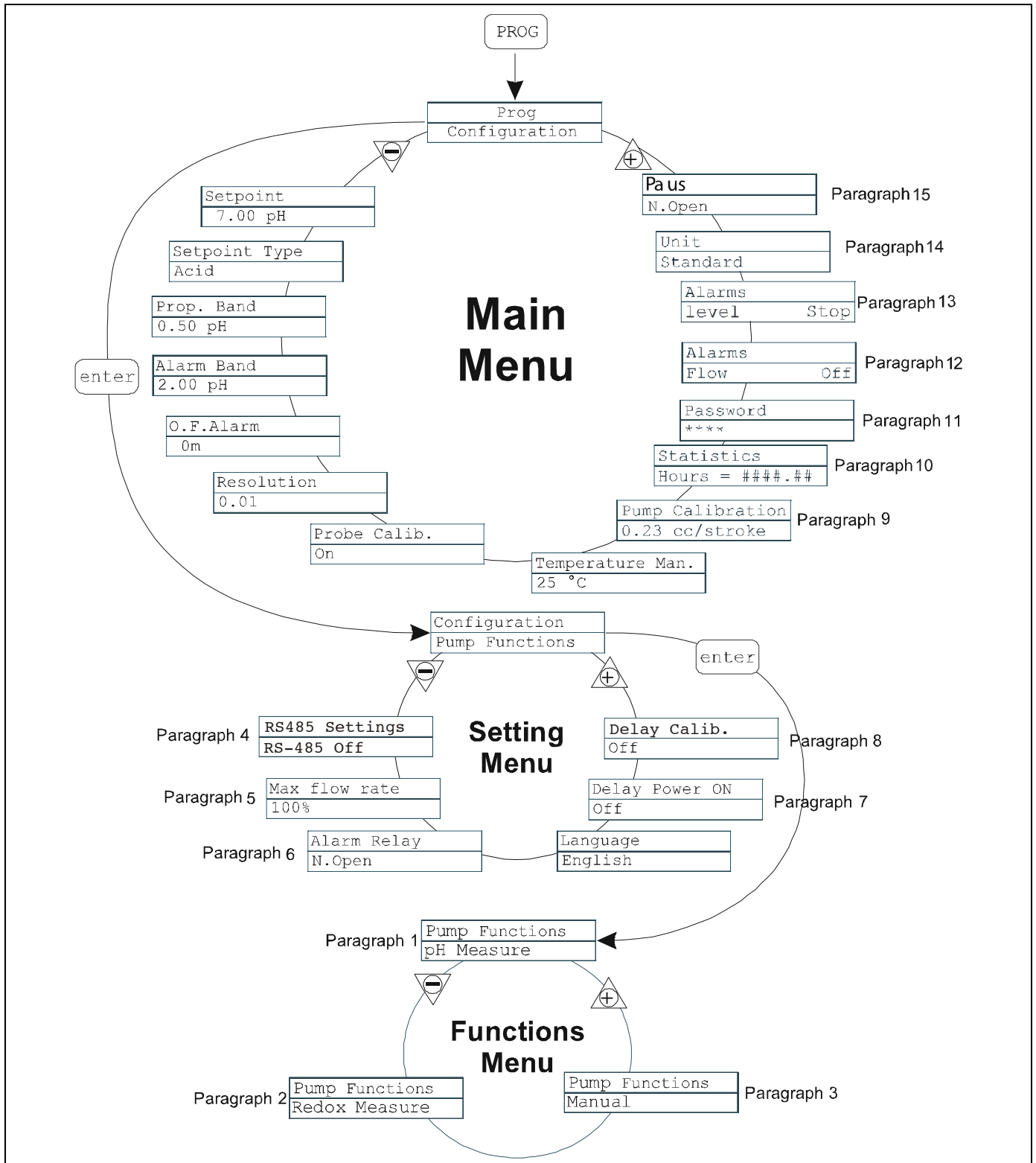
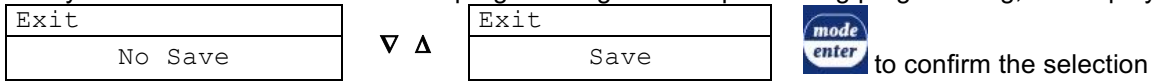

Setting the Language

Programming	Operation
<pre> graph TD A[PROG] --> B[PROG Configuration] B -- enter --> C[Configuration Pump Functions] C --> D[Max flow rate PI00%] D --> E[Alarm Relay N.Open] E --> F[Language English] F -- enter --> G[] G --> H[] </pre>	<p>Makes it possible to select the language. The pump is set in English in the factory.</p> <p>Changes can be made by pressing the key, then using the keys to set the new value. Press to confirm and return to the main menu</p>

Paragraph 1 – Dosage Proportional to the pH value

Programming	Operation
<pre> graph TD A[PROG] --> B[PROG Configuration] B -- enter --> C[Configuration Pump Functions] C -- enter --> D[Pump Functions pH Measure] D -- enter --> E[Setpoint 7.00 pH] E --> F[Setpoint Type Acid] F --> G[Prop. Band 0.50 pH] G --> H[Alarm Band 2.00 pH] H --> I[O.F. Alarm 0m] I --> J[Resolution 0.01] J --> K[Probe Calib. On] K --> L[Temperature Man. 25 °C] L --> M[Temperature Man. 77 °F] </pre>	<p>The pump measures and controls the pH of a solution, programming in sequence: set-point, set-point type, proportional band and alarm band</p> <p>Set-point type: acid</p> <p>Set-point type: alkaline</p> <p>It is also possible to programme:</p> <ul style="list-style-type: none"> - the O.F.A. (Over Feed Alarm) time in minutes, or rather a time beyond which an alarm signal is triggered if the pH value does not reach the set-point. - The measurement resolution (1 or 2 decimal points) - Deactivation/activation of the calibration procedure - Manual temperature value in °C (default) or °F <p>The maximum frequency can be modified during operation, by pressing the keys at the same time to increase the flow, or the keys to decrease it.</p>

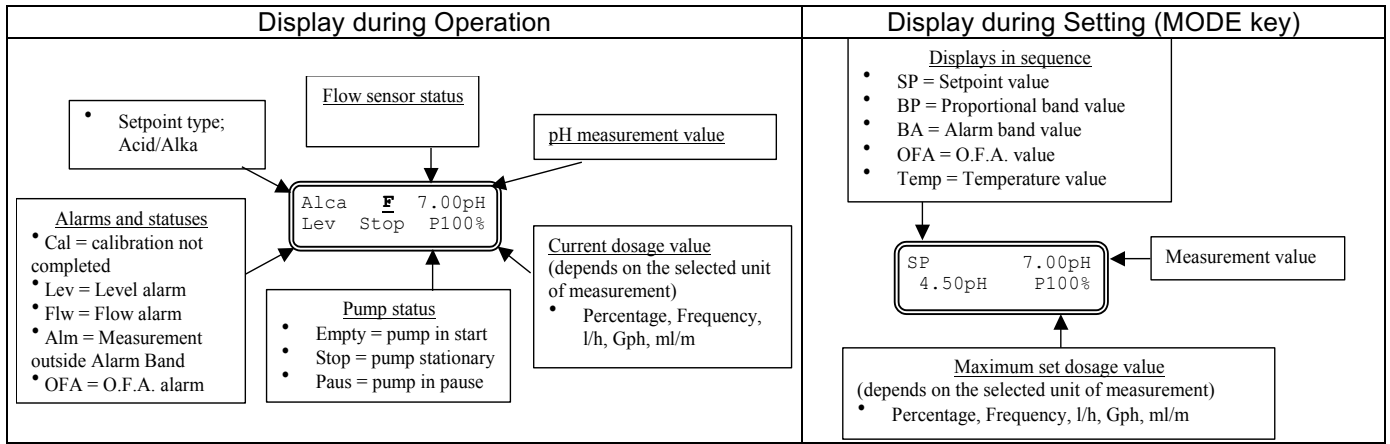

Paragraph 2 – Dosage Proportional to the Potential Redox Measurement (O.R.P.)

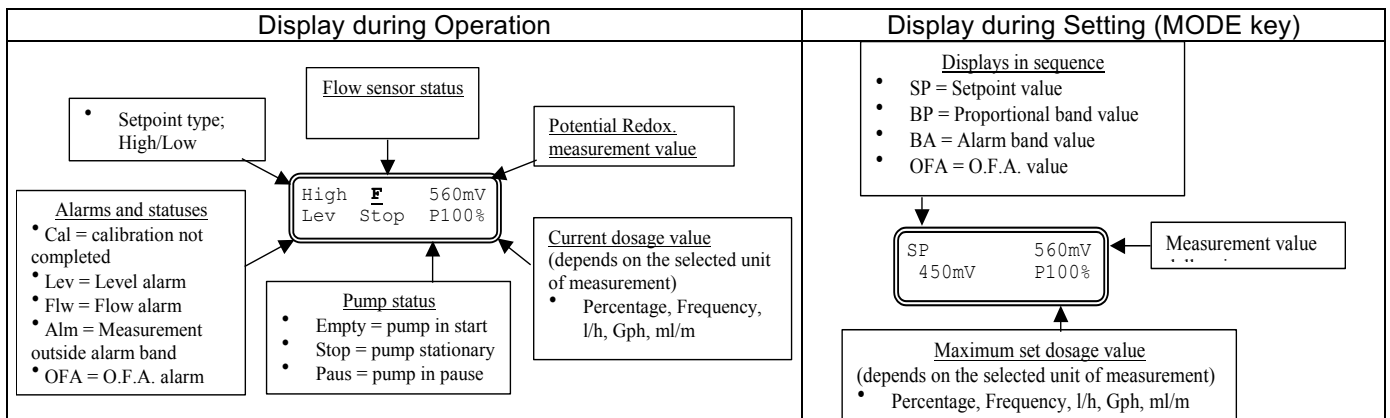
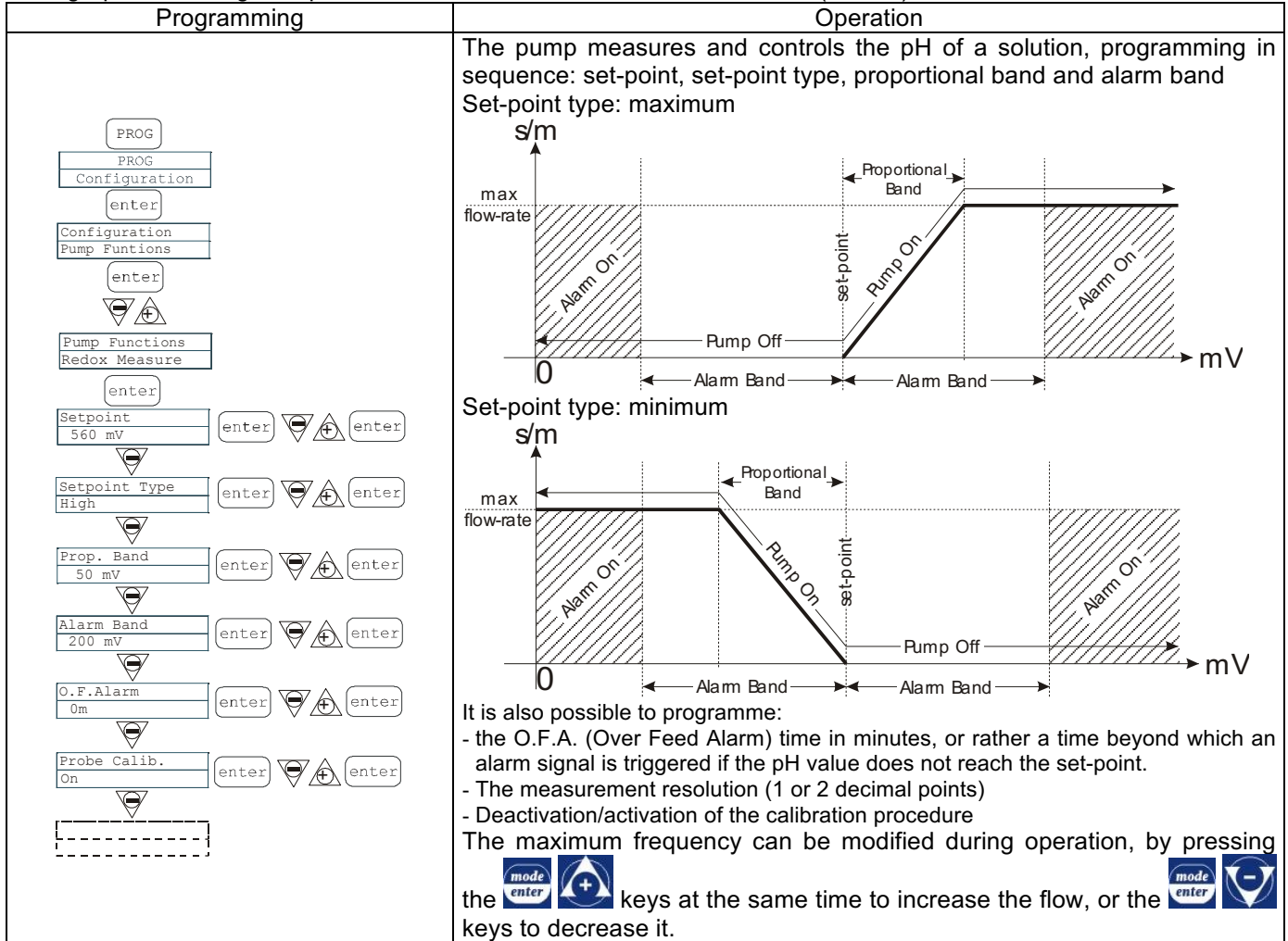

Paragraph 3 – Manual Dosage

Programming	Operation
<pre> graph TD A[PROG] --> B[PROG Configuration] B -- enter --> C[Configuration Pump Functions] C -- enter --> D[Manual] D -- enter --> E[] </pre>	<p>The pump operates in constant mode. The flow can only be manually regulated by pressing the keys at the same time to increase the flow, or the keys to decrease it.</p>

Display during Operation	Display during Setting (MODE key)
<p>Operating mode • Man = Manual</p> <p>FLOW sensor status</p> <p>Current dosage value (depends on the selected unit of measurement) • Percentage, Frequency, l/h, Gph, ml/m</p> <p>Alarms and statuses • Liv = Level alarm • Fls = Flow alarm</p> <p>Pump status • Empty = pump in start • Stop = pump stationary • Paus = pump in pause</p> <p>Display: MAN Lev Stop P100%</p>	<p>Operating mode • Displays the corresponding frequency value</p> <p>Display: F320s/m P100%</p> <p>Current dosage value • The maximum flow can be modified by pressing the + or – keys at the same time</p>

Paragraph 4 – RS485 Settings

Programming	Operation
<pre> graph TD A[PROG] --> B[PROG Configuration] B -- enter --> C[Configuration Pump Functions] C --> D[RS485 Settings RS-485 Off] D -- enter --> E[RS485 Settings RS-485 On] E -- enter --> F[RS485 Settings BaudRate 9600] F -- enter --> G[RS485 Settings Parity Even] G -- enter --> H[RS485 Settings Address 1] H -- enter --> I[RS485 Watchdog Timeout Off] I -- enter --> J[WDG Config. Hardware Reset] J -- enter --> K[] </pre>	<p>This makes it possible to activate (deactivate) the ModBus RS485 communication (On by Default). If Active in the menu will show following items:</p> <ul style="list-style-type: none"> -BaudRate: it's possible to set the BaudRate as 2400, 4800, 9600, 19200 or 38400 (9600 by Default). -Parity: it's possible to set the Parity as Even, Odd or No (disabled). -Address: it's possible to set the address communication of device from 1 to 247 (1 by Default). -Timeout: It's possible to set the Watchdog timeout, if Off is disabled otherwise it's possible to set a time from 1 to 65535 seconds (Off by Default). -Hardware Reset: it's possible to set the Watchdog communication as Hardware Reset, Com. Reset, Stop Dosage and WDG Alarm (WDG Alarm by Default) . <p>Changes can be made by pressing the key, then using the keys to set the new value. Press to confirm and return to the main menu</p>

Paragraph 5 – Setting the Maximum Flow

Programming	Operation
	<p>This makes it possible to set the maximum flow offered by the pump, and the programmed mode (% or frequency) is used as the standard unit of measurement when displaying the flow. Changes can be made by pressing the key, then using the keys to set the new value. Press to confirm and return to the main menu</p>

Paragraph 6 – Setting the Alarm Relay

Programming	Operation
	<p>In the absence of an alarm situation, it can be set as open (default) or closed.</p> <p>Changes can be made by pressing the key, then using the keys to set the new value. Press to confirm and return to the main menu</p>

Paragraph 7 – Power On Delay Setting

Programming	Operation
	<p>Allows the user to set a pump activation delay time when turning on the pump itself. This delay will only take effect if the pump is turned off and then on again by disconnecting its electrical power supply. The setting can be disabled (Off - factory default) or else can be set to a delay time ranging from 1 to 60 minutes. The alarm and pulse LED indicators will flash while the delay time is in progress (1 sec ON - 1 sec Off) and the countdown will be shown on the display in seconds. If the pump is in Stop mode, the LEDs alone will be flashing. While the time delay is in progress, the function can be disabled by accessing the menu and setting the time to Off.</p> <p>Press to access the modification option and use the and buttons to set the desired value. Press to confirm and return to the main menu.</p>

Paragraph 8 – Delay calibration Setting

Programming	Operation
<pre> graph TD A[PROG] --> B[PROG Configuration] B --> C[enter] C --> D[Configuration Pump functions] D --> E[Max flow rate 100%] E --> F[Alarm Relay N.Open] F --> G[Language English] G --> H[Delay Power ON Off] H --> I[Delay Calib. Off] I --> J[enter] J --> K[down arrow] K --> L[up arrow] L --> M[enter] M --> N[back arrow] N --> O[] </pre>	<p>Used to set a pump operation delay after calibration of the probe (Redox or pH). The setting can be disabled (Off - factory default) or else can be set to a delay time ranging from 1 to 60 minutes. The alarm and pulse LED indicators will flash while the delay time is in progress (1 sec ON - 1 sec Off) and the countdown will be shown on the display in seconds. If the pump is in Stop mode, the LEDs alone will be flashing. While the time delay is in progress, the function can be disabled by accessing the menu and setting the time to Off.</p> <p>Press to access the modification option and use the and buttons to set the desired value. Press to confirm and return to the main menu.</p>

Paragraph 9 – Flow Calibration

Programming	Operation
<pre> graph TD A[PROG] --> B[PROG Configuration] B --> C[] C --> D[Pump Calibration 0,23 cc/stroke] D --> E[enter] E --> F[Pump Calibration Manual] F --> G[enter] G --> H[Pump Calibration cc/stroke 0,23] H --> I[down arrow] I --> J[Pump Calibration Automatic] J --> K[enter] K --> L[Automatic Cal. Start 100 strok.] L --> M[enter] M --> N[Automatic Cal. Strokes 100] N --> O[down arrow] O --> P[Automatic Cal. ml 20] P --> Q[down arrow] Q --> R[up arrow] R --> S[enter] </pre>	<p>The memorized cc value per strike appears in the main menu. It can be calibrated in two different ways: MANUAL – manually enter the cc value per strike using the keys and confirm by pressing the key AUTOMATIC – the pump makes 100 strikes, which are started by pressing the key. At the end of this process, enter the quantity sucked up by the pump using the keys and confirm by pressing the key. The entered figure will be used in flow calculations.</p>

Paragraph 10 - Statistics

Programming	Operation
	<p>The main menu displays the pump operation times. By pressing the key you can access other statistics:</p> <ul style="list-style-type: none"> - Strokes = number of strokes made by the pump - Q.ty (L) = quantity dosed by the pump in litres; this figure is calculated on the basis of the memorised cc/stroke value - Power = number of pump starts <p>- Reset = use the to reset the counters (YES) or otherwise (NO), then confirm by pressing the key.</p> <p>Pressing the key will take you back to the main menu.</p>





Paragraph 11 - Password

Programming	Operation
	<p>By entering the password, you can enter the programming menu and see all the set values. The password will be requested whenever you seek to modify them. The flashing line indicates the number than can be modified. Use the key to select the number (from 1 to 9), and the key to select the number to be modified. Confirm by pressing the key. By setting "0000" (default), the password is eliminated.</p>





Paragraph 12 – Flow Alarm

Programming	Operation
	<p>This makes it possible to activate (deactivate) the flow sensor.</p> <p>When activated (On), press the key to access the request for the number of signals that the pump waits for before an alarm is triggered. The number flashes when you press the key, and you can then use the keys to set the value. Confirm by pressing the key. Press to return to the main menu</p>





Paragraph 13 – Level Alarm

Programming	Operation
	<p>This makes it possible to set the pump when the level sensor alarm is activated. In other words you can decide whether to stop dosage (Stop) or simply activate the alarm signal without stopping dosage.</p> <p>Changes can be made by pressing the  key, then using the   keys to set the alarm type. Confirm by pressing the  key. Press  to return to the main menu</p>

Paragraph 14 – Flow Display Unit

Programming	Operation
	<p>This makes it possible to set the dosage unit of measurement on the display.</p> <p>Changes can be made by pressing the  key, then using the   keys to set the unit of measurement, choosing between L/h (liters/hour), Gph (Gallons/hour), ml/m (milliliters/minute) or standard (% or frequency, depending on settings). Press  to confirm and return to the main menu</p>

Paragraph 15 - Setting the Pause

Programming	Operation
	<p>The pump can be paused by remote input. The factory setting is Normally Open.</p> <p>Changes can be made by pressing the  key, then using the   keys to set the new value (N. OPEN or N. CLOSED).</p> <p>Press  to confirm and return to the main menu.</p>

pH Calibration Menu

Pressing the CAL key for 3 seconds takes you into the calibration menu. If calibration was excluded during programming, the following appears on the display:

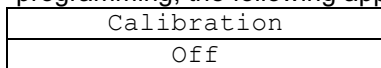

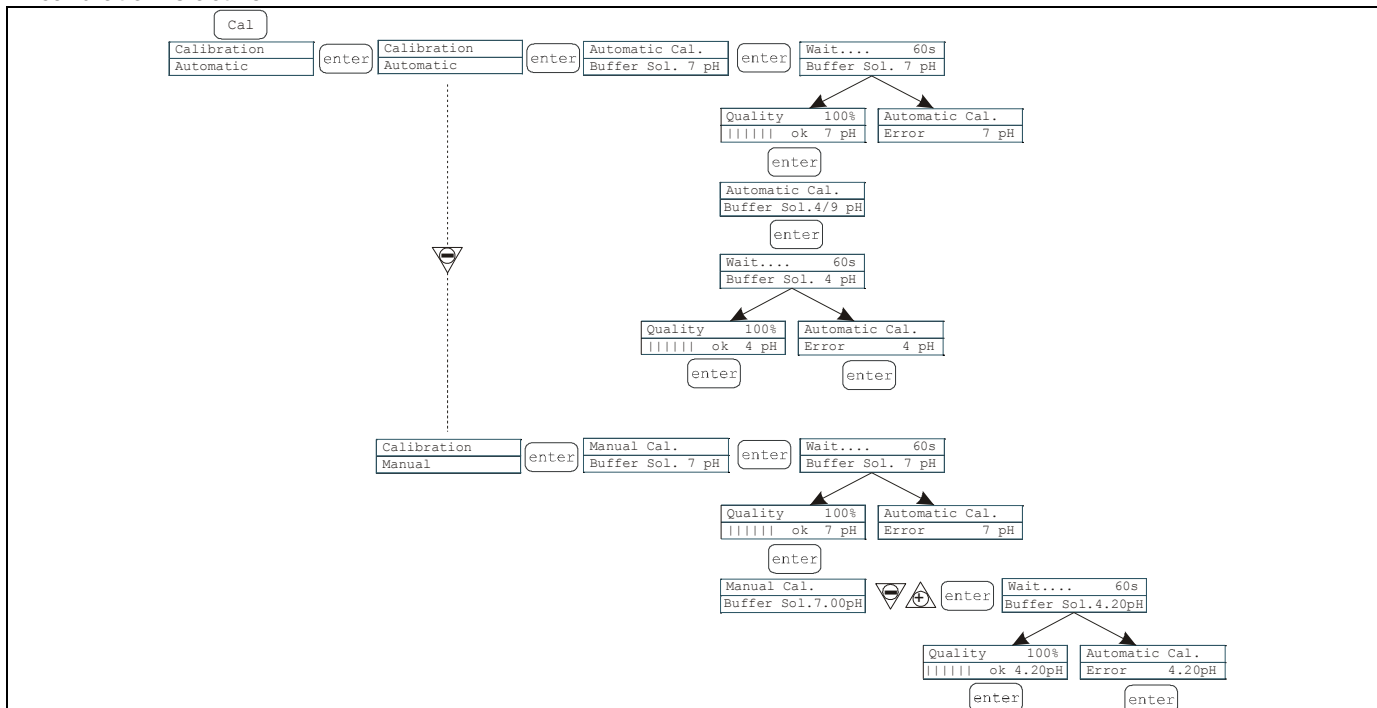

If calibration is active:





It is possible to select automatic or manual mode. In both cases, it is automatically calibrated to pH 7.



- Automatic calibration:

The buffer solution value appears on the display. Enter the probe in the bottle and press the  key. A 60 second countdown necessary to complete calibration will appear on the display. If the alignment quality is below 50%, an error message appears on the display and you should press  to exit calibration (the pump exits automatically after 4 seconds). If the quality is above 50%, the value is shown on the display and, after pressing the  key, the buffer solution at pH 4 or 9 will be requested. At this point the procedure is the same as above.

- Manual calibration:

when the buffer solution value appears on the display, insert the probe in the bottle and press the  key. A 60 second countdown necessary to complete calibration will appear on the display. If the alignment quality is below

50%, an error message appears on the display and you should press  to exit calibration (the pump exits automatically after 4 seconds). If the quality is above 50%, the value is shown on the display and, after pressing the

 key, the value of pH 7.00 flashes on the display. Use the  keys to enter the value of the solution in

your possession, then press  to confirm and start the calibration procedure as before.

Potential Redox Calibration Menu (O.R.P.)

Pressing the CAL key for 3 seconds takes you into the calibration menu. If calibration was excluded during programming, the following appears on the display:

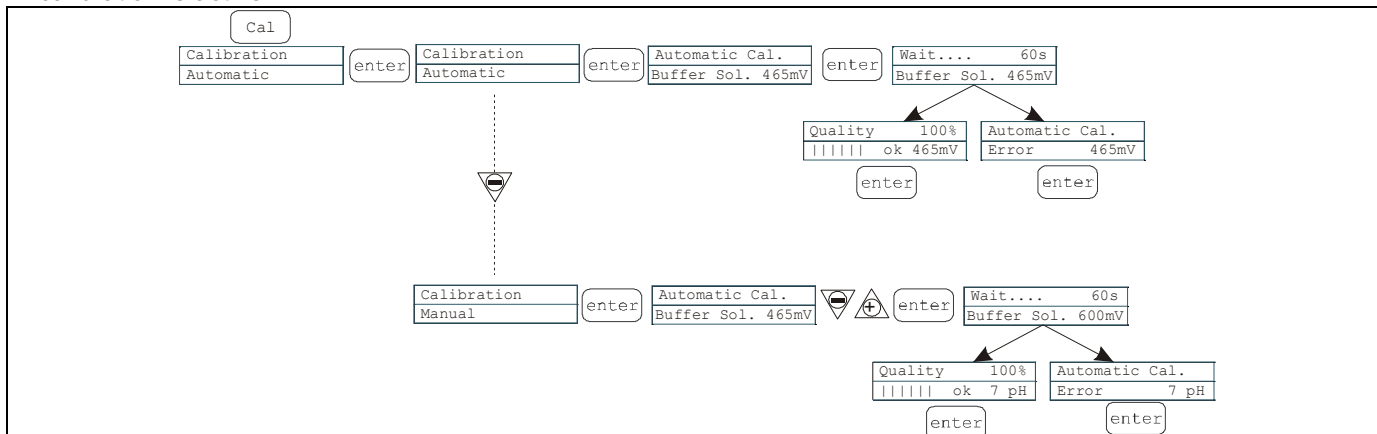

Calibration
Off

If calibration is active:







It is possible to select automatic or manual mode.





- Automatic calibration:

The buffer solution value appears on the display. Insert the probe in the bottle and press the  key. A 60 second countdown necessary to complete calibration will appear on the display. If the alignment quality is below 50%, an error message appears on the display and you should press  to exit calibration (the pump exits automatically after 4 seconds). If the quality is above 50%, the value is shown on the display and you should press the  key to complete the procedure.

- Manual calibration:

The buffer solution value appears on the display. Insert the probe in the bottle and press the  key. The value of 465 mV should now flash on the display. Insert the probe in your solution and use the   keys to display the value of the solution in your possession, then confirm by pressing the  key and begin the calibration procedure as before











Alarms

Display	Cause	Interruption						
Fixed alarm LED Flashing word "Lev" I.e. <table border="1" style="display: inline-table; vertical-align: middle;"><tr><td>Man</td><td></td></tr><tr><td>Lev</td><td>P100%</td></tr></table>	Man		Lev	P100%	End of level alarm, without interrupting pump operation	Restore the liquid level.		
Man								
Lev	P100%							
Fixed alarm LED Flashing words "Lev" and "stop" I.e. <table border="1" style="display: inline-table; vertical-align: middle;"><tr><td>Man</td><td></td></tr><tr><td>Lev Stop</td><td>P100%</td></tr></table>	Man		Lev Stop	P100%	End of level alarm, with interruption to pump operation	Restore the liquid level.		
Man								
Lev Stop	P100%							
Flashing word "Mem" I.e. <table border="1" style="display: inline-table; vertical-align: middle;"><tr><td>1:n</td><td>6</td></tr><tr><td>Mem</td><td></td></tr></table>	1:n	6	Mem		The pump receives one or more impulses during dosage with memory function on Off	Press the  key		
1:n	6							
Mem								
Flashing word "Mem" I.e. <table border="1" style="display: inline-table; vertical-align: middle;"><tr><td>1:n</td><td>M</td><td>6</td></tr><tr><td>Mem</td><td></td><td></td></tr></table>	1:n	M	6	Mem			The pump receives one or more impulses during dosage with memory function on On	When the pump finishes receiving external impulses, it returns the memorised strokes
1:n	M	6						
Mem								
Fixed alarm LED Flashing word "Flw" I.e. <table border="1" style="display: inline-table; vertical-align: middle;"><tr><td>Man</td><td>F</td></tr><tr><td>Flw</td><td>P100%</td></tr></table>	Man	F	Flw	P100%	Active flow alarm. The pump has not received the programmed number of signals from the flow sensor.	Press the  key		
Man	F							
Flw	P100%							
I.e. <table border="1" style="display: inline-table; vertical-align: middle;"><tr><td>Parameter Error</td><td>PROG</td></tr><tr><td>to default</td><td></td></tr></table>	Parameter Error	PROG	to default		Communication error with the eeprom.	Press the  key to restore the default parameters.		
Parameter Error	PROG							
to default								
Flashing word "OFA" Flashing word "stop" I.e. <table border="1" style="display: inline-table; vertical-align: middle;"><tr><td>High</td><td>475 mV OFA</td></tr><tr><td>Stop</td><td>P 75%</td></tr></table>	High	475 mV OFA	Stop	P 75%	O.F.A. alarm	Press the  key to stop the flashing word "stop". Press the key again to start up the pump again.		
High	475 mV OFA							
Stop	P 75%							
Flashing word "Alm" I.e. <table border="1" style="display: inline-table; vertical-align: middle;"><tr><td>High</td><td>475 mV Alm</td></tr><tr><td>P</td><td>75%</td></tr></table>	High	475 mV Alm	P	75%	The probe reading is outside the set alarm band range	Make sure that the "Alarm Band" parameter is set correctly in the programme		
High	475 mV Alm							
P	75%							
Flashing word "Cal" I.e. <table border="1" style="display: inline-table; vertical-align: middle;"><tr><td>High</td><td>475 mV Cal</td></tr><tr><td>P</td><td>75%</td></tr></table>	High	475 mV Cal	P	75%	Probe not calibrated alarm	Calibrate the probe		
High	475 mV Cal							
P	75%							
Fixed alarm LED Flashing word "WDG" I.e. <table border="1" style="display: inline-table; vertical-align: middle;"><tr><td>Man</td><td>F</td></tr><tr><td>WDG</td><td>P100%</td></tr></table>	Man	F	WDG	P100%	Watchdog Alarm, ModBus communication error	Press the  key		
Man	F							
WDG	P100%							

OPTIMA PLUS

Steuertafel



	Zugriff auf das Programmiermenü
	Während des Pumpenbetriebs: Durch Drücken werden die programmierten Werte zyklisch auf dem Display angezeigt; bei gleichzeitigem Drücken der Tasten   wird ein Wert, je nach ausgewähltem Betriebsmodus, erhöht bzw. verringert. Während der Programmierung übernimmt diese Taste die Funktion "Enter", d.h. dass der Zugriff auf die verschiedenen Menüstufen und die dort vorgenommenen Veränderungen bestätigt werden.
	Startet und stoppt die Pumpe. Wenn ein Füllstandsalarm (nur Alarmfunktion), ein Durchflussalarm und ein Memoryalarm aktiv ist, deaktiviert diese Taste die Anzeige auf dem Display.
	Zum "Verlassen" der verschiedenen Menüstufen. Vor dem endgültigen Verlassen der Programmierung, öffnet sich ein Speicherungsdialog für Veränderungen.
	Zugriff auf das Kalibrierungsmenü der Pumpe. Im Off-Modus wird das Kalibrierungsmenü nicht aktiviert.
	Blättert nach oben im Menü, oder erhöht die numerischen Werte, die verändert werden sollen. Im Batch-Modus kann diese Taste die Dosierung starten.
	Blättert nach unten im Menü, oder verringert die numerischen Werte, die verändert werden sollen.
	Grüne Led, die während dem Dosiervorgang blinkt.
	Rote Led, die sich bei den verschiedenen Alarmsituationen einschaltet.

Anschlüsse Elektrik

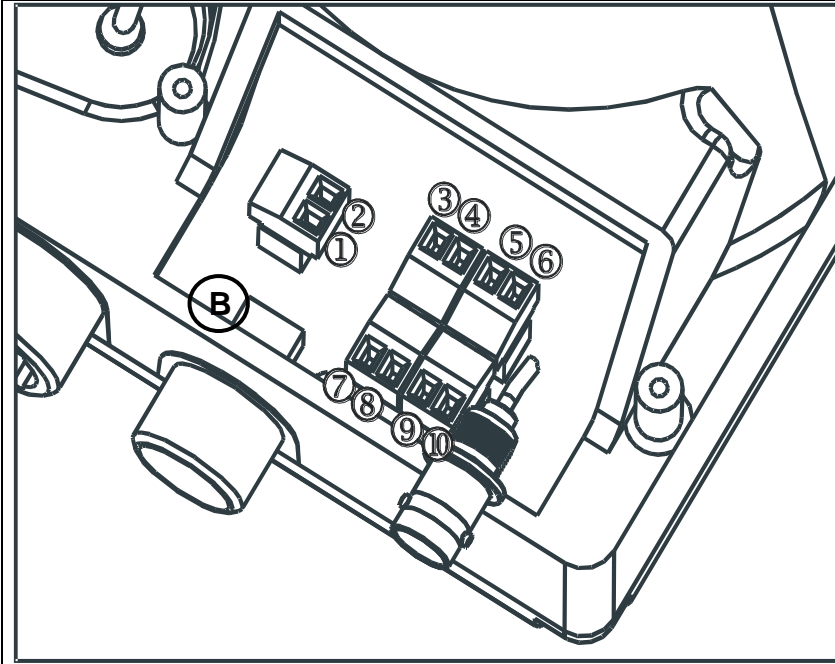

1	Alarmausgang (Schließer / NO)	
2	durch Relais	
3	Positiv (+)	4-20 mA Ausgangssignal max 500ohm
4	Negativ (-)	
5	Eingang Fernbedienung(Start-Stop)	
6		
7	Eingang Temperaturfühler	
8		
9	Eingang Flusssensor	
10		
B	Eingang Füllstandskontrolle	

Modbusanbindung	
Pin N°	Beschreibung
1	T+R+
2	T-R-
3	GND
4	Nicht benutzt

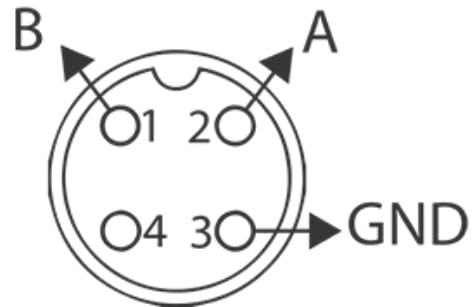



Durch über drei Sekunden langes Drücken der Taste erhalten Sie Zugriff auf die Programmierung. Über die Tasten können Sie die Menüpunkte durchblättern. Über die Taste erhalten Sie Zugriff auf die Veränderungen. Werkseitig ist die Pumpe auf den Konstant-Modus programmiert. Die Pumpe kehrt nach 1 Minute Inaktivität automatisch zum Betriebs-Modus zurück. In diesem Fall werden etwaig eingegebene Daten nicht gespeichert.

Über die Taste verlassen Sie die Programmierstufen. Bei Verlassen der Programmierung wird auf dem Display folgendes angezeigt:

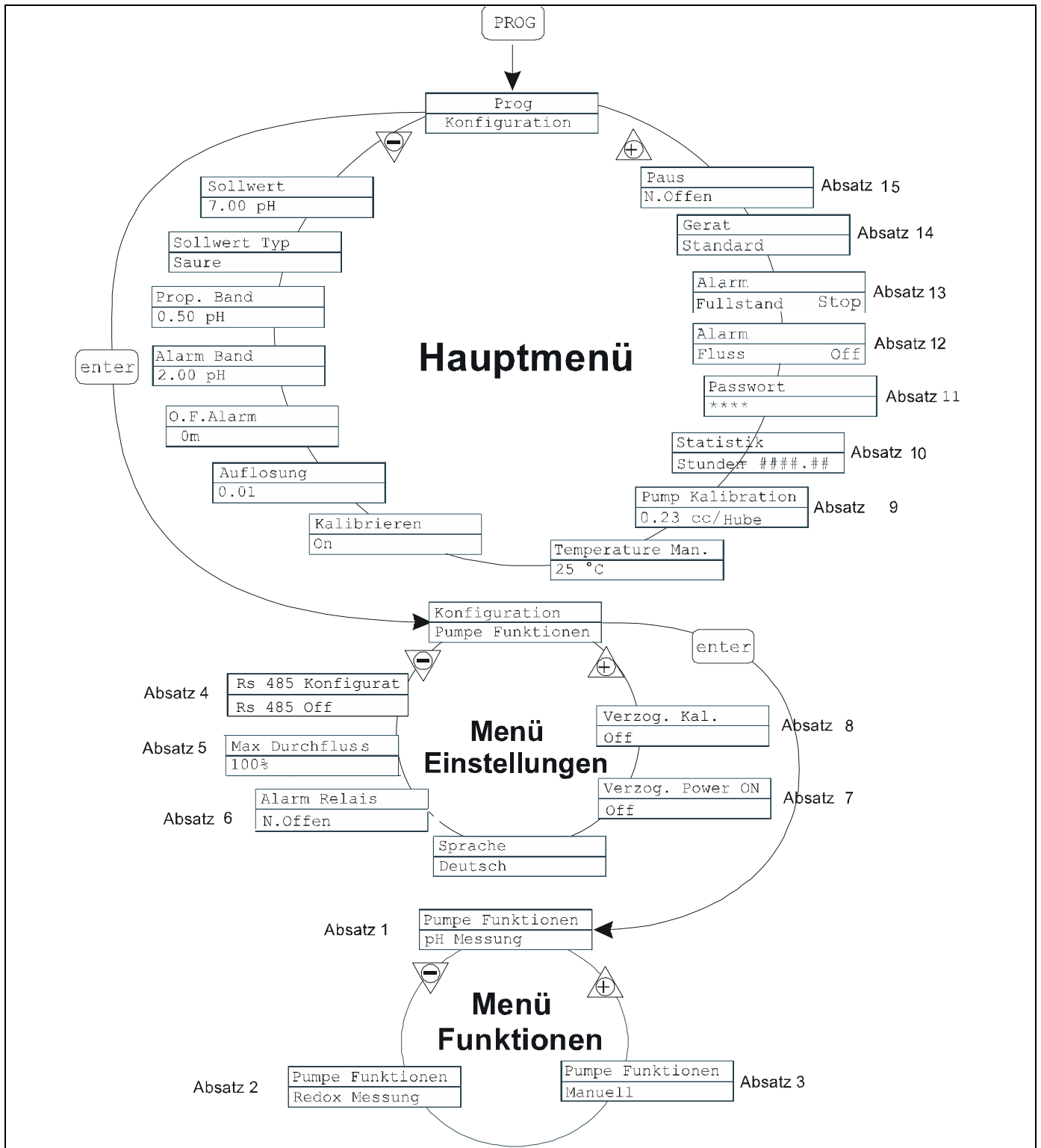

Sprachauswahl

Programmierung	Funktionsweise
	<p>Ermöglicht die Sprachauswahl. Werkseitig ist die Sprache Englisch eingestellt.</p> <p>Durch Drücken von erhalten Sie Zugriff auf die Veränderung. Stellen Sie dann über die Tasten den Wert ein. Über bestätigen Sie und werden zum Hauptmenü zurückgeleitet.</p>

Absatz 1 –Manuelle Dosierung

Programmierung	Funktionsweise
	<p>Die Pumpe arbeitet im Konstant-Modus. Die Förderleistung wird manuell geregelt. Durch gleichzeitiges Drücken der Tasten wird die Förderleistung erhöht bzw. über die Tasten verringert.</p>

Anzeige während des Betriebs	Anzeige während der Einstellung (Taste MODE)
<div style="display: flex; justify-content: space-between;"> <div style="border: 1px solid black; padding: 5px;"> <p>Betriebs-Modus</p> <ul style="list-style-type: none"> Man = Manuell </div> <div style="border: 1px solid black; padding: 5px;"> <p>Zustand Durchflusssensor</p> </div> <div style="border: 1px solid black; padding: 5px;"> <p>Wert der laufenden Dosierung (hängt von der ausgewählten Messeinheit ab)</p> <ul style="list-style-type: none"> %, Frequenz, l/h, Gph, ml/m </div> </div> <div style="text-align: center; margin: 10px 0;"> <div style="border: 2px solid black; padding: 5px; display: inline-block;"> MAN Lev Stop P100% </div> </div> <div style="display: flex; justify-content: space-between;"> <div style="border: 1px solid black; padding: 5px;"> <p>Alarmer und Zustände</p> <ul style="list-style-type: none"> Liv = Füllstandsalarm Fls = Durchflussalarm </div> <div style="border: 1px solid black; padding: 5px;"> <p>Zustand der Pumpe</p> <ul style="list-style-type: none"> Leer = Pumpenstart Stop = Pumpe steht Pause = Pumpe in Pause </div> </div>	<div style="border: 1px solid black; padding: 5px; margin-bottom: 10px;"> <p>Betriebs-Modus</p> <ul style="list-style-type: none"> Zeigt den der Frequenz entsprechenden Wert an </div> <div style="text-align: center; margin: 10px 0;"> <div style="border: 2px solid black; padding: 5px; display: inline-block;"> F320s/m P100% </div> </div> <div style="border: 1px solid black; padding: 5px;"> <p>Wert der laufenden Dosierung</p> <ul style="list-style-type: none"> Verändert die maximale Förderleistung durch gleichzeitiges Drücken der Tasten + und - </div>

Absatz 2 – Dosierung proportional zur Messung des pH-Werts (werkseitige Einstellung)

Programmierung	Funktionsweise
	<p>Die Pumpe misst und überwacht den pH-Wert durch die aufeinander folgende Programmierung folgender Werte: Set-Point, Art des Set-Points, Proportionalbereich und Alarmbereich.</p> <p>Art des Set-Points: sauer</p> <p>Art des Set-Points: alkalisch</p> <p>Ferner kann folgendes programmiert werden:</p> <ul style="list-style-type: none"> - Die O.F.A.-Zeit (Over Feed Alarm) in Minuten, d.h. einen Zeitraum, über den hinaus eine Alarmsignal aktiviert wird, wenn die Messung des pH-Werts den Set-Point nicht erreicht. - Die Auflösung der Messung (1 oder 2 Dezimalstellen) - Deaktivierung/Aktivierung des Kalibrierverfahrens - Manueller Wert der Temperatur in °C (werkseitige Einstellung) oder °F <p>Die Höchsfrequenz kann während des Betriebs verändert werden. Durch gleichzeitiges Drücken der Tasten wird die Förderleistung erhöht bzw. über die Tasten verringert.</p>

Anzeige während des Betriebs	Anzeige während der Einstellung (Taste MODE)
<div style="display: flex; justify-content: space-between;"> <div style="border: 1px solid black; padding: 5px; width: 30%;"> <p>• Art des Set-Points; sauer/alkalisch</p> </div> <div style="border: 1px solid black; padding: 5px; width: 30%; text-align: center;"> <p>Zustand des Durchflusssensors</p> </div> <div style="border: 1px solid black; padding: 5px; width: 30%; text-align: center;"> <p>pH-Messwert</p> </div> </div> <div style="border: 1px solid black; padding: 5px; margin-top: 10px; text-align: center;"> <p>Alca F 7.00pH Lev Stop P100%</p> </div> <div style="display: flex; justify-content: space-between; margin-top: 10px;"> <div style="border: 1px solid black; padding: 5px; width: 30%;"> <p><u>Alarime und Zustände</u></p> <ul style="list-style-type: none"> • Cal = Kalibrierung nicht durchgeführt • Lev = Füllstandsalarm • Flw = Durchflussalarm • Alm = Messung ausserhalb des Alarmbereichs • OFA = O.F.A. Alarm </div> <div style="border: 1px solid black; padding: 5px; width: 30%;"> <p><u>Zustand der Pumpe</u></p> <ul style="list-style-type: none"> • Leer = Pumpenstart • Stop = Pumpe steht • Pause = Pumpe in Pause </div> <div style="border: 1px solid black; padding: 5px; width: 30%;"> <p><u>Wert der laufenden Dosierung</u> (hängt von der ausgewählten Messeinheit ab)</p> <ul style="list-style-type: none"> • %, Frequenz, l/h, Gph, ml/m </div> </div>	<p>Der Reihe nach wird angezeigt:</p> <ul style="list-style-type: none"> • SP = Set-Point-Wert • BP = Wert Proportionalbereich • BA = Wert Alarmbereich • OFA = O.F.A.-Wert • Temp = Temperaturwert <div style="border: 1px solid black; padding: 5px; margin-top: 10px; text-align: center;"> <p>SP 7.00pH 4.50pH P100%</p> </div> <p style="text-align: right; margin-right: 20px;">Messwert</p> <div style="border: 1px solid black; padding: 5px; margin-top: 10px;"> <p><u>Eingestellter Höchstwert der Dosierung</u> (hängt von der ausgewählten Messeinheit ab)</p> <ul style="list-style-type: none"> • %, Frequenz, l/h, Gph, ml/m </div>

Absatz 7 – Einstellung der Einschaltverzögerung

Programmierung	Funktionsweise
	<p>Mit dieser Funktion kann man eine Einschaltverzögerung des Pumpenbetriebs einstellen. Diese Verzögerung tritt nur dann ein, wenn die Pumpe durch Unterbrechung der Stromversorgung aus- und wieder eingeschaltet wird.</p> <p>Diese Einstellung kann deaktiviert werden, indem man sie auf Off (werkseitige Einstellung) stellt, oder man wählt eine Verzögerung zwischen 1 und 60 Minuten.</p> <p>Bei aktivierter Einschaltverzögerung blinken die Alarm- und Impuls-Led während der eingestellten Zeit gleichzeitig (1 Sek. On – 1 Sek. Off) und auf dem Display wird der Countdown der verbleibenden Sekunden angezeigt. Steht die Pumpe auf Stopp werden nur die blinkenden Leds angezeigt. Die Funktion kann während der Verzögerungszeit über das Menü auf OFF gestellt und somit deaktiviert werden.</p> <p>Mit der Taste gelangt man zur Bearbeitung, dann mit den den Wert eingeben. Mit bestätigen und zurück zum Hauptmenü.</p>

Absatz 8 – Einstellung der Verzögerungskalibrierung

Programmierung	Funktionsweise
	<p>Gestattet die Einstellung einer Verzögerung des Betriebs der Pumpe nach der Kalibrierung der Sonde (Redox oder pH).</p> <p>Diese Einstellung kann deaktiviert werden, indem man sie auf Off (werkseitige Einstellung) stellt, oder man wählt eine Verzögerung zwischen 1 und 60 Minuten.</p> <p>Bei aktivierter Einschaltverzögerung blinken die Alarm- und Impuls-Led während der eingestellten Zeit gleichzeitig (1 Sek. On – 1 Sek. Off) und auf dem Display wird der Countdown der verbleibenden Sekunden angezeigt. Steht die Pumpe auf Stopp werden nur die blinkenden Leds angezeigt. Die Funktion kann während der Verzögerungszeit über das Menü auf OFF gestellt und somit deaktiviert werden.</p> <p>Mit der Taste gelangt man zur Bearbeitung, dann mit den den Wert eingeben. Mit bestätigen und zurück zum Hauptmenü.</p>

Absatz 9 – Kalibrierung der Förderleistung

Programmierung	Funktionsweise
	<p>Im Hauptmenü erscheint das gespeicherte Hubvolumen. Es kann auf zwei Arten kalibriert werden:</p> <p>MANUELL – Geben Sie über die Tasten manuell das Hubvolumen ein und bestätigen Sie über die Taste gestartet werden. Wenn diese Hübe ausgeführt worden sind, geben Sie über die Tasten die von der Pumpe angesaugte Menge ein und bestätigen Sie über .</p> <p>Der eingegebene Wert wird bei der Berechnung der Förderleistungen verwendet.</p>

Absatz 10 – Statistiken

Programmierung	Funktionsweise
	<p>Im Hauptmenü werden die Betriebsstunden der Pumpe angezeigt. Durch Drücken der Taste erhalten Sie Zugriff auf die anderen Statistiken:</p> <ul style="list-style-type: none"> - Strokes = Anzahl der von der Pumpe ausgeführten Hübe - Q.ty(L) = in Litern ausgedrückte von der Pumpe dosierte Menge; dieser Wert wird entsprechend des gespeicherten Hubvolumens berechnet. - Power = Anzahl der Pumpenstarts - Reset = über die Tasten können Sie die Uhr auf Null stellen (YES) oder nicht (NO), über bestätigen Sie. <p>Durch Drücken von gelangen Sie zum Hauptmenü zurück.</p>

Absatz 11 – Passwort

Programmierung	Funktionsweise
	<p>Durch Eingabe des Passworts erhalten Sie Zugriff auf die Programmierung und können sich alle eingegebenen Werte ansehen. Jedes Mal wenn Sie versuchen, diese Werte zu verändern, erscheint ein eigener Passwortdialog. Die blinkende Linie zeigt die veränderbare Nummer an.</p> <p>Wählen Sie über die Taste die Nummer aus (zwischen 1 und 9), wählen Sie über die Taste die Nummer aus, die verändert werden soll, und bestätigen Sie anschließend über . Durch Eingabe von "0000" (werkseitige Einstellung) wird die Passwortabfrage übersprungen.</p>

Absatz 12 – Durchflussalarm

Programmierung	Funktionsweise
	<p>Ermöglicht die Aktivierung (Deaktivierung) des Durchflusssensors.</p> <p>Wenn er einmal aktiviert ist (ON), erhalten Sie durch Drücken der Taste Zugriff auf den Abfragedialog, wie viele Signale die Pumpe abwartet, bevor Sie einen Alarm auslöst. Durch Drücken von beginnt die Nummer zu blinken. Stellen Sie dann über die Tasten den Wert ein. Über bestätigen Sie. Durch Drücken von werden Sie zum Hauptmenü zurückgeleitet.</p>

Absatz 13 – Füllstandsalarm

Programmierung	Funktionsweise
	<p>Ermöglicht die Einstellung des Zeitpunkts, an dem der Füllstandsalarm aktiviert, d.h. die Dosierung blockiert wird (Stop), oder einfach nur das Alarmsignal aktiviert werden soll, ohne dabei die Dosierung zu blockieren.</p> <p>Durch Drücken von erhalten Sie Zugriff auf die Veränderung. Stellen Sie dann über die Tasten die Alarmart ein. Über bestätigen Sie. Durch Drücken von werden Sie zum Hauptmenü zurückgeleitet.</p>

Absatz 14 – Anzeigeeinheit der Förderleistung

Programmierung	Funktionsweise
	<p>Ermöglicht die Einstellung der Maßeinheit der Dosierung über eine Anzeige auf dem Display.</p> <p>Durch Drücken von erhalten Sie Zugriff auf die Veränderung. Stellen Sie dann über die Tasten die gewünschte Maßeinheit ein, L/H (Liter/Stunde), GpH (Gallone/Stunde), ml/m (Milliliter/Minute) oder die Standardeinstellung (% oder Frequenz, je nach Einstellung). Über bestätigen Sie und werden zum Hauptmenü zurückgeleitet</p>

Absatz 15 - Einstellung Pause

Programmierung	Funktionsweise
	<p>Steuereingang: Pumpe Stop / Start. Werkseinstellung: Bei Schließerkontakt (elektrisch leitende Verbindung zwischen beiden Anschlussklemmen) Pumpenstop.</p> <p>Durch Drücken von erhalten Sie Zugriff auf die Veränderung.</p> <p>Stellen Sie dann über die Tasten den Wert ein (N. OFFEN oder N. GESCHLOSSEN).</p> <p>Über bestätigen Sie und werden zum Hauptmenü zurückgeleitet.</p>

Menü zur Kalibrierung des pH-Wert

Durch 3 Sekunden langes Drücken der Taste CAL erhalten Sie Zugriff auf das Kalibriermenü. Wenn die Kalibrierung während der Programmierung ausgeschlossen wurde, wird auf dem Display folgendes angezeigt:

Kalibration
Off

Wenn die Kalibrierung aktiv ist:

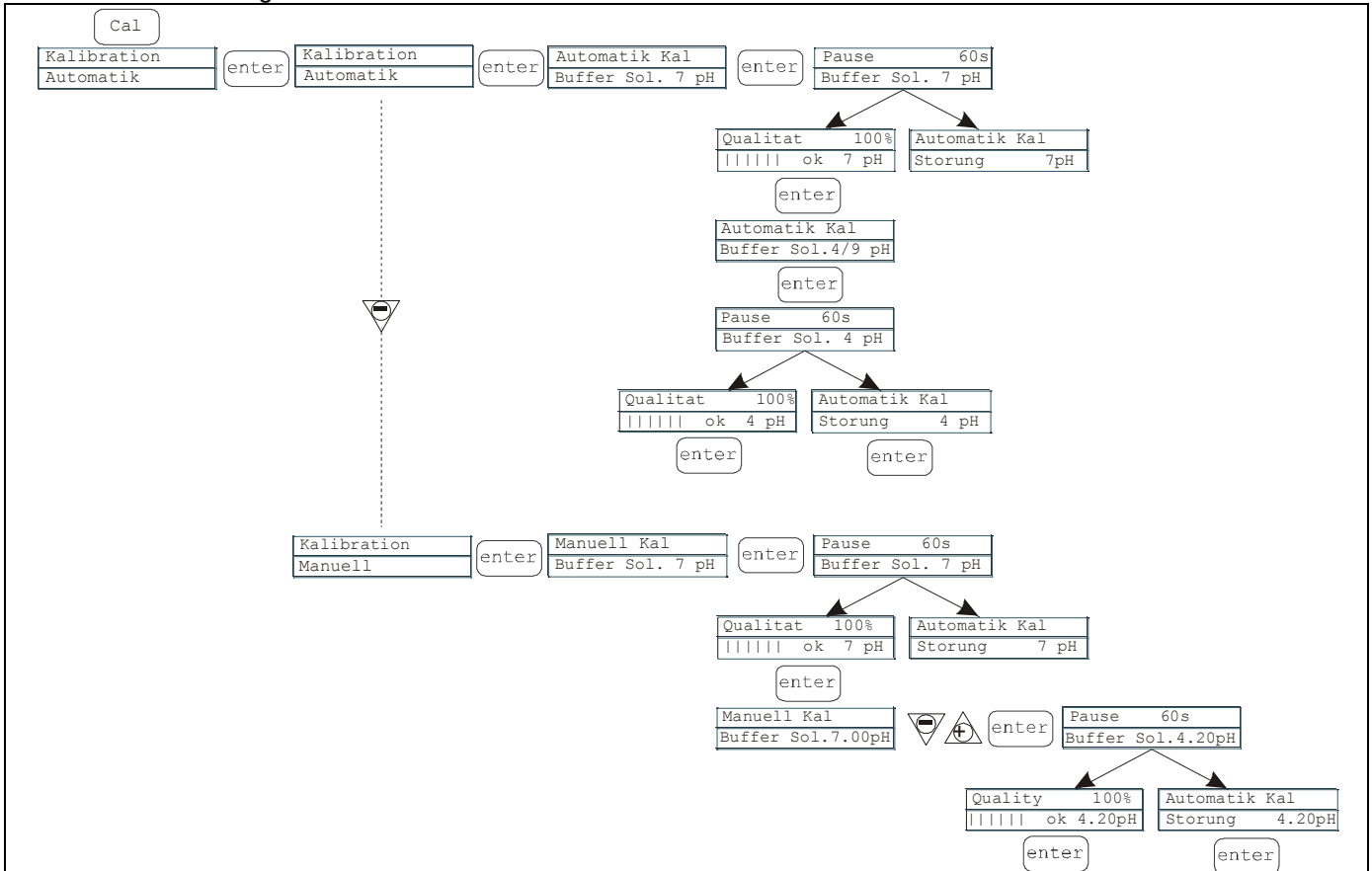

Es ist möglich, die automatische oder die manuelle Kalibrierung zu wählen. In beiden Fällen erfolgt die Kalibrierung auf den pH-Wert 7 automatisch.

- Automatische Kalibrierung:

Auf dem Display erscheint der Wert der Pufferlösung. Die Sonde in das Fläschchen einführen, durch Drücken von



erscheint auf dem Display die Rückwärtszählung der für die vollständige Durchführung der Kalibrierung erforderlichen 60 Sekunden. Wenn die Qualität des Abgleichs unter 50% liegt, erscheint eine Fehlermeldung auf



dem Display und durch Drücken von



verlassen Sie die Kalibrierung (nach 4 Sekunden verlässt die Pumpe die Kalibrierung automatisch). Wenn die Qualität des Abgleichs über 50% liegt, wird der Wert auf dem Display



angezeigt und durch Drücken von



wird die Pufferlösung mit pH-Wert 4 oder 9 gefordert; an diesem Punkt ist das Verfahren identisch zum zuvor liegenden Verfahren.

- Manuelle Kalibrierung:

Wenn auf dem Display der Wert der Pufferlösung erscheint, die Sonde in das Fläschchen einführen, durch



Drücken von



erscheint auf dem Display die Rückwärtszählung der für die vollständige Durchführung der Kalibrierung erforderlichen 60 Sekunden. Wenn die Qualität des Abgleichs unter 50% liegt, erscheint eine



Fehlermeldung auf dem Display und durch Drücken von





verlassen Sie die Kalibrierung (nach 4 Sekunden verlässt die Pumpe die Kalibrierung automatisch). Wenn die Qualität des Abgleichs über 50% liegt, wird der Wert



auf dem Display angezeigt und durch Drücken von



blinkt der pH-Wert 7.00 auf dem Display. Geben Sie über die Tasten   den Wert der zur Verfügung stehenden Pufferlösung ein, bestätigen Sie durch Drücken von  und starten Sie das Kalibrierverfahren wie zuvor.

Menü zur Kalibrierung des Redox-Potentials (O.R.P.)

Durch 3 Sekunden langes Drücken der Taste CAL erhalten Sie Zugriff auf das Kalibriermenü, wenn die Kalibrierung während der Programmierung ausgeschlossen wurde, wird auf dem Display folgendes angezeigt:

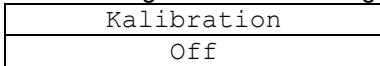

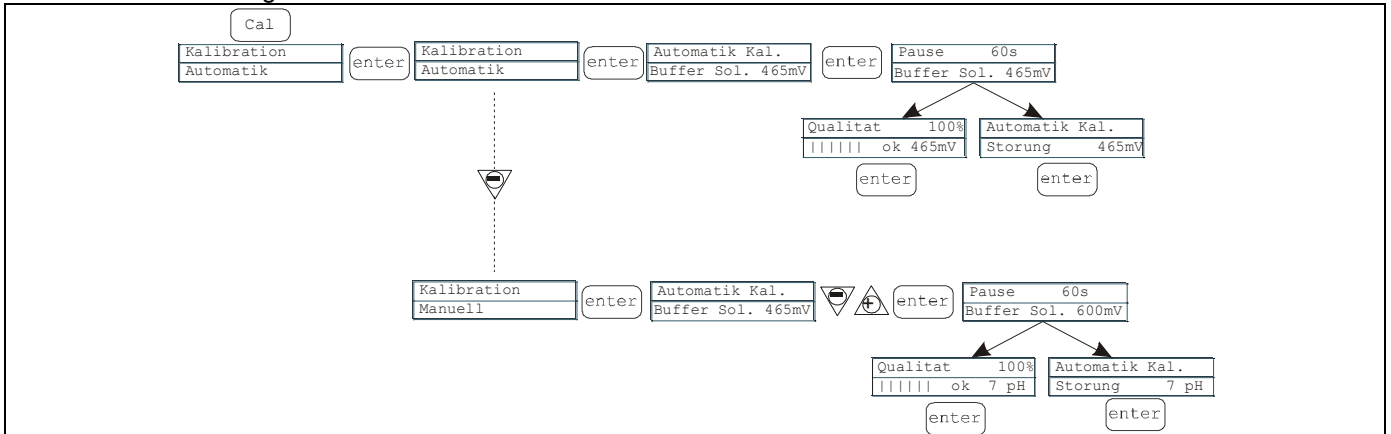

Wenn die Kalibrierung aktiv ist:







Es ist möglich, die automatische oder die manuelle Kalibrierung zu wählen.





- Automatische Kalibrierung:

Auf dem Display erscheint der Wert der Pufferlösung. Die Sonde in das Fläschchen einführen, durch Drücken von  erscheint auf dem Display die Rückwärtszählung der für die vollständige Durchführung der Kalibrierung erforderlichen 60 Sekunden. Wenn die Qualität des Abgleichs unter 50% liegt, erscheint eine Fehlermeldung auf dem Display und durch Drücken von  verlassen Sie die Kalibrierung (nach 4 Sekunden verlässt die Pumpe die Kalibrierung automatisch). Wenn die Qualität des Abgleichs über 50% liegt, wird der Wert auf dem Display angezeigt und durch Drücken von  wird das Verfahren zu Ende geführt.

- Manuelle Kalibrierung:

Auf dem Display erscheint der Wert der Pufferlösung. Die Sonde in das Fläschchen einführen, durch Drücken von  blinkt der Wert 465mV auf dem Display. Führen Sie die Sonde in Ihre Lösung ein und zeigen Sie dann über die Tasten   den Wert der zur Verfügung stehenden Lösung an. Durch Drücken von  bestätigen Sie und starten das Kalibrierverfahren wie zuvor.











Alarme

Anzeige	Ursache	Unterbrechung		
Alarm-Led leuchtet kontinuierlich Der Schriftzug Lev blinkt Bsp.: <table border="1" style="display: inline-table; vertical-align: middle;"><tr><td>Man</td></tr><tr><td>Lev P100%</td></tr></table>	Man	Lev P100%	Alarm Füllstand nicht ausreichend, ohne Unterbrechung des Pumpenbetriebs	Flüssigkeit nachfüllen
Man				
Lev P100%				
Alarm-Led leuchtet kontinuierlich Der Schriftzug Lev und Stop blinkt Bsp.: <table border="1" style="display: inline-table; vertical-align: middle;"><tr><td>Man</td></tr><tr><td>Lev Stop P100%</td></tr></table>	Man	Lev Stop P100%	Alarm Füllstand nicht ausreichend, mit Unterbrechung des Pumpenbetriebs	Flüssigkeit nachfüllen
Man				
Lev Stop P100%				
Der Schriftzug Mem blinkt Bsp.: <table border="1" style="display: inline-table; vertical-align: middle;"><tr><td>1:n 6</td></tr><tr><td>Mem</td></tr></table>	1:n 6	Mem	Die Pumpe empfängt einen oder mehrere Impulse während der Dosierung mit Memory-Funktion in Off-Stellung	Die Taste  drücken
1:n 6				
Mem				
Der Schriftzug Mem blinkt Bsp.: <table border="1" style="display: inline-table; vertical-align: middle;"><tr><td>1:n <u>M</u> 6</td></tr><tr><td>Mem</td></tr></table>	1:n <u>M</u> 6	Mem	Die Pumpe empfängt einen oder mehrere Impulse während der Dosierung mit Memory-Funktion in On-Stellung	Wenn die Pumpe keine externen Impulse mehr empfängt, führt sie die gespeicherten Hübe aus
1:n <u>M</u> 6				
Mem				
Alarm-Led leuchtet kontinuierlich Der Schriftzug Flw blinkt Bsp.: <table border="1" style="display: inline-table; vertical-align: middle;"><tr><td>Man <u>F</u></td></tr><tr><td>Flu P100%</td></tr></table>	Man <u>F</u>	Flu P100%	Durchflussalarm aktiv, die Pumpe hat nicht die programmierten Signale vom Durchflusssensor empfangen.	Die Taste  drücken
Man <u>F</u>				
Flu P100%				
Bsp.: <table border="1" style="display: inline-table; vertical-align: middle;"><tr><td>Param. Störung</td></tr><tr><td>Programm störung</td></tr></table>	Param. Störung	Programm störung	Kommunikationsfehler mit dem EEPROM	Die Taste  drücken, um auf die Default-Parameter rückzustellen.
Param. Störung				
Programm störung				
Der Schriftzug „OFA“ blinkt Der Schriftzug „Stop“ blinkt Bsp.: <table border="1" style="display: inline-table; vertical-align: middle;"><tr><td>Hoch 475 mV OFA</td></tr><tr><td>Stop P 75%</td></tr></table>	Hoch 475 mV OFA	Stop P 75%	O.F.A.-Alarm	Die Taste  drücken, um das Blinken des Schriftzugs Stop anzuhalten. Die Taste erneut drücken, um die Pumpe wieder zu starten.
Hoch 475 mV OFA				
Stop P 75%				
Der Schriftzug „Alm“ blinkt Bsp.: <table border="1" style="display: inline-table; vertical-align: middle;"><tr><td>Hoch 475 mV Alm</td></tr><tr><td>P 75%</td></tr></table>	Hoch 475 mV Alm	P 75%	Der von der Sonde gemessene Wert befindet sich außerhalb des eingestellten Alarmbereichs	Die richtige Einstellung des Parameters „Alarmbereich“ in der Programmierung überprüfen.
Hoch 475 mV Alm				
P 75%				
Der Schriftzug „OFA“ blinkt Bsp.: <table border="1" style="display: inline-table; vertical-align: middle;"><tr><td>Hoch 475 mV Cal</td></tr><tr><td>P 75%</td></tr></table>	Hoch 475 mV Cal	P 75%	Alarm Sonde nicht kalibriert	Die Kalibrierung der Sonde vornehmen.
Hoch 475 mV Cal				
P 75%				

OPTIMA PLUS

Panel de control



	Acceso al menú de programación.
	Durante el funcionamiento de la bomba: Si se pulsa visualiza cíclicamente en el display los valores programados; si se pulsa simultáneamente a las teclas   aumenta o disminuye un valor dependiente del modo de funcionamiento escogido. En programación ejerce la función “enter”, es decir, confirma la entrada en los diferentes niveles del menú y las modificaciones en el interior de los mismos.
	Pone en marcha y detiene la bomba. En condiciones de alarma de nivel (sólo función de alarma), de alarma de flujo y alarma <i>memory</i> activas, desactiva la señalización en el display.
	Para “salir” de los diferentes niveles del menú. Antes de salir definitivamente de la programación se accede a la solicitud de memorización de las modificaciones.
	Acceso al menú de calibración de la bomba. Si está en modo OFF, el menú de calibración no se activa.
	Desplaza los menús hacia arriba o aumenta los valores numéricos a modificar. En modo Batch puede poner en marcha la dosificación.
	Desplaza los menús hacia abajo o disminuye los valores numéricos a modificar.
	Led verde parpadeante durante la dosificación.
	Led rojo que se enciende durante las diferentes situaciones de alarma.

Conexiones eléctricas

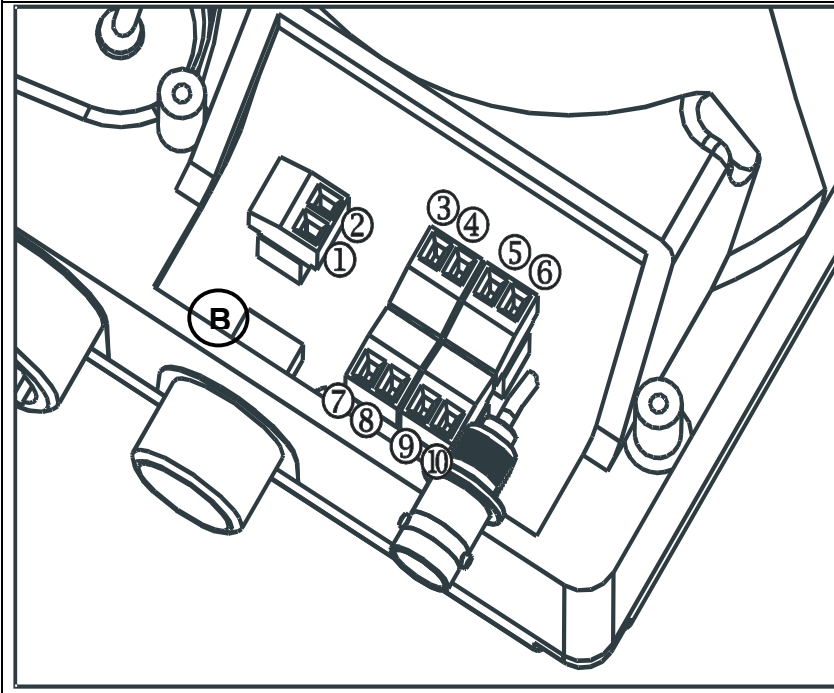



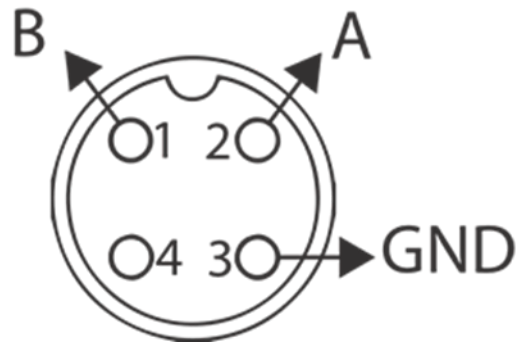

1	Relé de Alarma	
2		
3	Pole +	Salida 4-20 mA max 500ohm
4	Pole -	
5	Entrada control externo (start-stop)	
6		
7	Entrada sensor de temperatura	
8		
9	Entrada sensor de Flujo	
10		
B	Entrada sonda de nivel	

Conexión ModBus

Pin N°	Descripción
1	T+R+
2	T-R-
3	GND
4	No utilizado



Pulsando la tecla  durante más de tres segundos se accede a la programación. Con las teclas   se pueden desplazar las voces del menú, con la tecla  se accede a las modificaciones. En la fábrica la bomba se programa en modo constante. La bomba vuelve automáticamente al modo de funcionamiento después de 1 minuto de inactividad. En este caso los datos que se han introducido no serán memorizados. Con la tecla  se sale de los niveles de la programación. Al salir de la programación el display visualiza:

Exit
No Save

▽ ▲

Exit
Save



para confirmar la elección

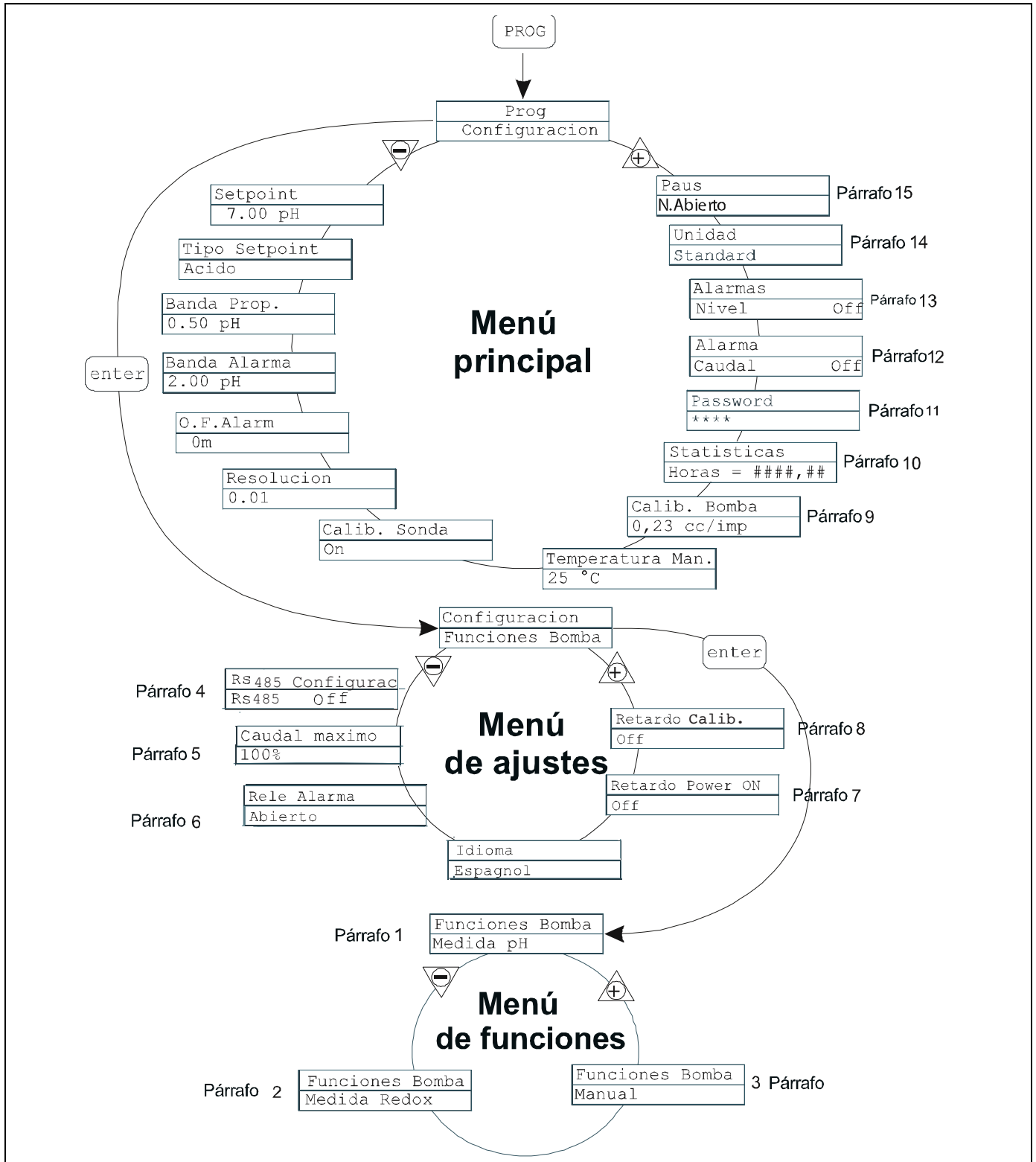

Programación del idioma

Programación	Funcionamiento
<p>The diagram illustrates the sequence of menu screens for language programming. It starts with 'PROG', followed by 'Configuration', 'Pump Functions', 'Max flow rate P100%', 'Alarm Relay N.Open', and 'Language English'. Navigation is performed using arrow keys and the 'enter' key. A dashed box at the bottom indicates the return to the main menu.</p>	<p>Permite seleccionar el idioma, en la fábrica la bomba se programa en inglés. Pulsando la tecla se accede a la modificación, con las teclas se programa el valor. Con la tecla se confirma y se vuelve al menú principal.</p>

Párrafo 1 – Dosificación manual

Programación	Funcionamiento
<p>The diagram shows the programming steps for manual dosing: 'PROG', 'Configuración', 'Funciones Bomba', and 'Manual'. Navigation is done with arrow keys and 'enter'. A dashed box at the bottom indicates the return to the main menu.</p>	<p>La bomba trabaja en modo constante. El caudal se regula manualmente pulsando simultáneamente las teclas para aumentar el caudal o las teclas para disminuirlo.</p>





Visualización durante el funcionamiento	Visualización en programación (tecla MODE)
<p>The diagram shows the display during operation with the following components:</p> <ul style="list-style-type: none"> Modo de funcionamiento: Man = Manual Estado del sensor de FLUJO: F (Flow sensor status) Valor de la dosificación en curso: (depende de la unidad de medida seleccionada) <ul style="list-style-type: none"> Porcentaje, Frecuencia, l/h, Gph, ml/m Estado de la bomba: <ul style="list-style-type: none"> Vacio = bomba en start Stop = bomba parada Pausa = bomba en pausa Alarmas y estados: <ul style="list-style-type: none"> Liv = Alarma de nivel Fls = Alarma de flujo <p>The display itself shows: MAN, Lev, Stop, P100%.</p>	<p>The diagram shows the display during programming (MODE) with the following components:</p> <ul style="list-style-type: none"> Modo de funcionamiento: Visualiza el valor correspondiente de la frecuencia Valor de la dosificación en curso: <ul style="list-style-type: none"> Modifica el caudal máximo pulsando simultáneamente las teclas + o - <p>The display shows: F320s/m, P100%.</p>

Párrafo 2 – Dosificación proporcional a la medida del pH (programación en la fábrica)

Programación	Funcionamiento
	<p>La bomba mide y controla el valor del pH de una solución programando en secuencia: Set-point, tipo de set-point, banda proporcional y banda de alarma.</p> <p>Tipo de set-point: Ácido</p> <p>Tipo de set-point: Alcalino</p> <p>Además, se puede programar:</p> <ul style="list-style-type: none"> - El tiempo O.F.A. (Over Feed Alarm) en minutos, es decir el tiempo después del cual se activa una señal de alarma si la medida del pH no alcanza el set-point. - La resolución de la medida (1 ó 2 cifras decimales). - Desactivación/activación del procedimiento de calibración. - Valor manual de la temperatura en °C (fábrica) o °F. <p>La frecuencia máxima se puede modificar durante el funcionamiento pulsando simultáneamente las teclas para aumentar el caudal, o las teclas para disminuirlo.</p>

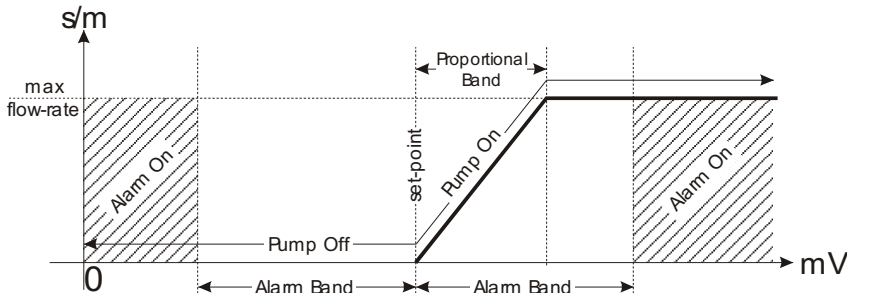
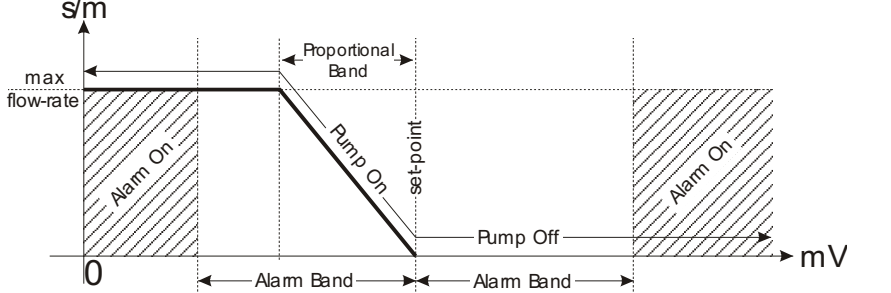
Visualización durante el funcionamiento	Visualización en programación (tecla MODE)
	<p><u>Visualiza en secuencia</u></p> <ul style="list-style-type: none"> • SP = valor del Setpoint • BP = valor de la banda proporcional • BA = valor de la banda de alarma • OFA = valor O.F.A. • Temp = valor de temperatura

Párrafo 3 – Dosificación Proporcional a la medida del potencial Redox (O.R.P.)

Programación	Funcionamiento
<p> (PROG) Prog Configuración (enter) Configuración Funciones Bomba (enter) Funciones Bomba Medida Redox (enter) Setpoint 560 mV (enter) (▼) (▲) (enter) Tipo Setpoint Alto (enter) (▼) (▲) (enter) Banda prop. 50 mV (enter) (▼) (▲) (enter) Banda alarma 200 mV (enter) (▼) (▲) (enter) O.F. Alarme 0m (enter) (▼) (▲) (enter) Calib. sonda On (enter) (▼) (▲) (enter) </p>	<p>La bomba mide y controla el valor del pH de una solución programando en secuencia: Set-point, tipo de set-point, banda proporcional y banda de alarma.</p> <p>Tipo de set-point: Máxima</p>  <p>Tipo de set-point: mínima</p>  <p>Además, se puede programar:</p> <ul style="list-style-type: none"> - El tiempo O.F.A. (Over Feed Alarm) en minutos, es decir el tiempo después del cual se activa una señal de alarma si la medida del pH no alcanza el set-point. - La resolución de la medida (1 ó 2 cifras decimales). - Desactivación/activación del procedimiento de calibración. <p>La frecuencia máxima se puede modificar durante el funcionamiento pulsando simultáneamente las teclas   para aumentar el caudal, o las teclas   para disminuirlo.</p>

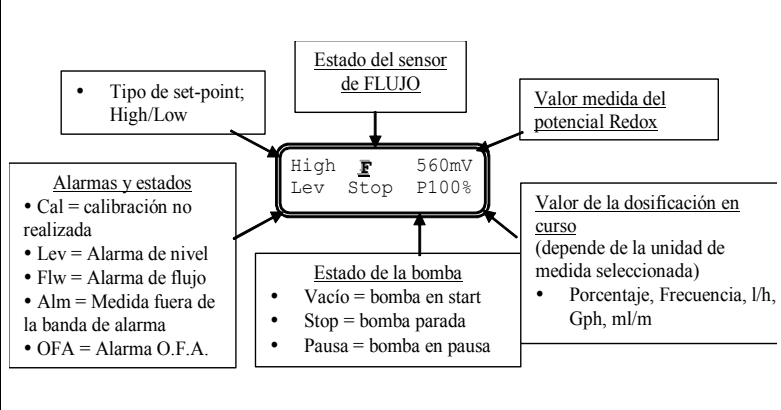
Visualización durante el funcionamiento	Visualización en programación (tecla MODE)
 <p> • Tipo de set-point; High/Low Estado del sensor de FLUJO Valor medida del potencial Redox High 560mV Lev Stop P100% Alarmas y estados • Cal = calibración no realizada • Lev = Alarma de nivel • Flw = Alarma de flujo • Alm = Medida fuera de la banda de alarma • OFA = Alarma O.F.A. Estado de la bomba • Vacío = bomba en start • Stop = bomba parada • Pausa = bomba en pausa Valor de la dosificación en curso (depende de la unidad de medida seleccionada) • Porcentaje, Frecuencia, l/h, Gph, ml/m </p>	<p>Visualiza en secuencia</p> <ul style="list-style-type: none"> • SP = valor del Set-point • BP = valor de la banda proporcional • BA = valor de la banda alarma • OFA = Valor O.F.A. <p> SP 560mV 450mV P100% ← Valor de la medida </p> <p>Valor de la dosificación máxima programada (depende de la unidad de medida seleccionada) • Porcentaje, Frecuencia, l/h, Gph, ml/m</p>

Párrafo 4 – RS485 Configurac.

programación	operación
	<p>Esto hace que sea posible activar (desactivar) la comunicación Modbus RS485 (por defecto) .</p> <p>Si activa en el menú mostrará los siguientes elementos :</p> <ul style="list-style-type: none"> -BaudRate: es posible ajustar la velocidad de transmisión como 2400, 4800 , 9600 , 19200 o 38400 (9600 por defecto) . -Parity : Es posible ajustar la paridad como par , impar o No (desactivado) -Direccion: es posible ajustar la dirección de comunicación del dispositivo desde 1 a 247 (1 por defecto) . -Timeout: Es posible ajustar el tiempo de espera de vigilancia , en caso de desactivación de lo contrario es posible establecer un tiempo de 1 a 65535 segundos (desactivada de forma predeterminada) . -Hardware Reset: es posible establecer la comunicación de perro guardián que Reset hardware , Com . Reset, Parada de Dosificación y alarma WDG (WDG alarma por defecto) . <p>Los cambios se pueden hacer presionando la key, a continuación, utilizando el keys para establecer el nuevo valor . .</p> <p>Presionando para confirmar y volver al menú principal</p>

Párrafo 5 – Programación del caudal máximo

Programación	Funcionamiento
	<p>Permite programar el caudal máximo que la bomba puede alcanzar; el modo programado (% o frecuencia) se vuelve la visualización del caudal en la unidad de medida estándar. Pulsando la tecla se accede a la modificación, después con las teclas se programa el valor. Con la tecla se confirma y se vuelve al menú principal.</p>

Párrafo 6 – Programación del relé de alarma

Programación	Funcionamiento
	<p>Sirve para programar el relé de alarma en ausencia de una situación de alarma si está abierto (fábrica) o cerrado.</p> <p>Pulsando la tecla se accede a la modificación, después con las teclas se programa el valor.</p> <p>Con la tecla se confirma y se vuelve al menú principal.</p>

Párrafo 7– Configuración Retardo Power On

Programación	Funcionamiento
	<p>Permite configurar un retardo del funcionamiento de la bomba al encenderse la misma. Este retardo tiene efecto sólo si la bomba se apaga y se vuelve a encender quitando la alimentación.</p> <p>La configuración puede deshabilitarse, Off (fábrica) o se puede configurar con un retardo de 1 a 60 minutos.</p> <p>Con el retardo activo, durante el tiempo configurado el led alarma y de impulso parpadean contemporáneamente (1 seg On – 1 seg Off) y la pantalla muestra el conteo en segundos. Si la bomba está en Stop, se visualizan sólo los led parpadeantes. Durante el tiempo de retardo puede desactivarse la función accediendo al menú, configurando el tiempo en Off.</p> <p>Presionando se accede a la modificación, con las teclas configuro el valor. Con confirmo y vuelvo al menú principal.</p>

Párrafo 8 – Configuración Retardo calibración

Programación	Funcionamiento
	<p>Permite configurar un retardo del funcionamiento de la bomba después de la calibración de la sonda (Redox o pH).</p> <p>La configuración puede deshabilitarse, Off (fábrica) o se puede configurar con un retardo de 1 a 60 minutos.</p> <p>Con el retardo activo, durante el tiempo configurado el led alarma y de impulso parpadean contemporáneamente (1 seg On – 1 seg Off) y la pantalla muestra el conteo en segundos. Si la bomba está en Stop, se visualizan sólo los led parpadeantes. Durante el tiempo de retardo puede desactivarse la función accediendo al menú, configurando el tiempo en Off.</p> <p>Presionando se accede a la modificación, con las teclas configuro el valor. Con confirmo y vuelvo al menú principal.</p>

Párrafo 9 – Calibración del caudal

Programación	Funcionamiento
	<p>En el menú principal aparece el valor de cc por golpe en memoria. Se puede calibrar en dos modos:</p> <p>MANUAL – Introduciendo manualmente el valor de cc por golpe con las teclas y confirmando con la tecla .</p> <p>AUTOMÁTICA – La bomba realiza 100 golpes que se activan y confirman con la tecla , al final introducir la cantidad aspirada por la bomba con las teclas y confirmar con la tecla . El dato introducido será utilizado en los cálculos de los caudales.</p>

Párrafo 10 - Estadísticas

Programación	Funcionamiento
<p>The diagram illustrates the menu navigation for statistics. It starts with the 'PROG' button, leading to the 'Configuración' menu. From there, it navigates through 'Statistics' to 'Horas' (10), 'Inyecciones' (1000), 'Cant. (l)' (100), and 'Arranques' (10). The 'Reset Estat.' option is set to 'NO'. Pressing 'ESC' returns to the 'Statistics' menu, showing 'Horas' (10).</p>	<p>En el menú principal visualiza las horas de funcionamiento de la bomba, pulsando la tecla se accede a las demás estadísticas:</p> <ul style="list-style-type: none"> - <i>Strokes</i> = Número de golpes realizados por la bomba. - <i>Q.ty (L)</i> = cantidad dosificada por la bomba expresada en litros; este valor se calcula en base al valor <i>cc/stroke</i> en memoria. - <i>Power</i> = Número de puestas en marcha de la bomba. <p>- <i>Reset</i> = Con las teclas se pueden poner en cero (YES) o no (NO) los contadores, con la tecla se confirma. Pulsando la tecla se vuelve al menú principal.</p>





Párrafo 11 - Password

Programación	Funcionamiento
<p>The diagram shows the password programming process. It starts with 'PROG' leading to 'Configuración', then to the 'Password' field (****). After pressing 'enter', the password '0000' is entered. Pressing 'ESC' returns to the main menu.</p>	<p>Introduciendo la password se puede entrar en programación y ver todos los valores programados, pero cada vez que se quiera realizar una modificación será solicitada la password. La línea parpadeante indica el número que se puede modificar, con la tecla se selecciona el número (de 1 a 9), con la tecla se selecciona el número a modificar y con la tecla se confirma. Programando "0000" (fábrica) la password queda excluida.</p>





Párrafo 12 – Alarma de flujo

Programación	Funcionamiento
<p>The diagram illustrates the flow alarm programming steps. It starts with 'PROG' leading to 'Configuración', then to 'Alarma Caudal' (Off). Pressing 'enter' leads to 'Alarma Caudal' (On). Pressing 'enter' again leads to 'Alarma Caudal-On Señales' (6). Pressing 'ESC' returns to 'Alarma Caudal' (Off).</p>	<p>Permite activar (desactivar) el sensor de flujo. Una vez activado (ON) pulsando la tecla se accede a la solicitud de cuántas señales espera la bomba antes de entrar en alarma. Pulsando la tecla el número parpadea, con las teclas se puede programar el valor. Con la tecla se confirma. Pulsando la tecla se vuelve al menú principal.</p>





Párrafo 13 – Alarma de nivel

Programación	Funcionamiento
	<p>Permite programar la bomba cuando se activa la alarma del sensor de nivel, es decir, si se bloquea la dosificación (Stop) o simplemente activa la señal de alarma sin bloquear la dosificación. Pulsando  la tecla se accede a la modificación, con las teclas   se puede programar el tipo de alarma. Con la tecla  se confirma. Pulsando la tecla  se vuelve al menú principal.</p>

Párrafo 14 – Unidad de visualización del caudal

Programación	Funcionamiento
	<p>Permite programar la unidad de medida de la dosificación con el display en visualización. Pulsando la tecla  se accede a la modificación, con las teclas   se programa el tipo de unidad de medida, l/h (litros/hora), Gph (galones/hora), ml/m (mililitros/minuto) o estándar (% o frecuencia, según como haya sido programado). Con la tecla  se confirma y se vuelve al menú principal.</p>

Párrafo 15 – Programación Pausa

Programación	Funcionamiento
	<p>Entrada externa de paro de bomba. De fábrica el sistema llega configurado como Normalmente Abierto. Pulsando la tecla  se accede a la modificación, después con las teclas   se programa el valor (N. ABIERTO o N. CERRADO.) Con la tecla  se confirma y se vuelve al menú principal.</p>

Menú calibración pH

Pulsando la tecla CAL por tres segundos se entra en el menú calibración, si en programación la calibración ha sido excluida, en el display aparece:

Calibration
Off

Si la calibración está activa:

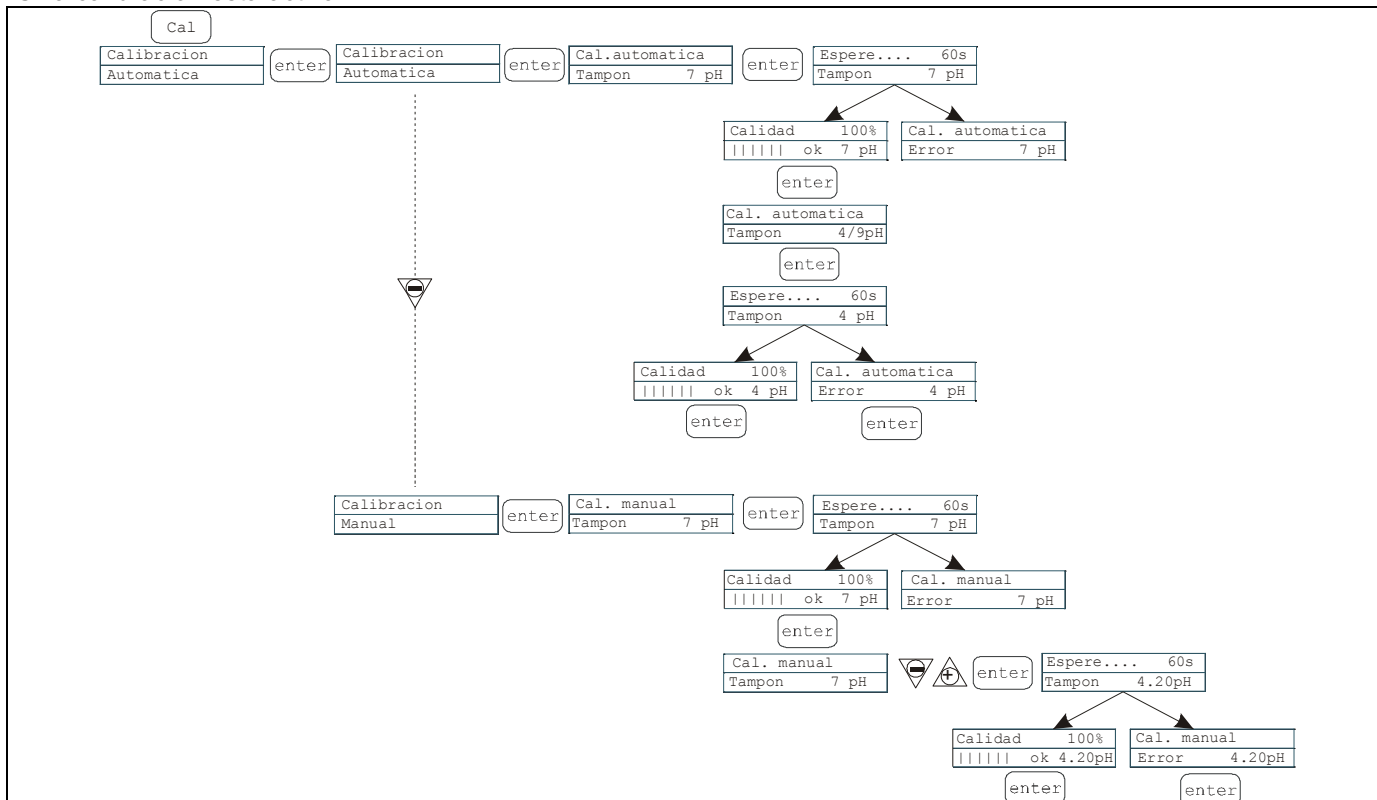

Es posible elegir el modo automático o manual, en ambos casos la calibración con pH 7 se lleva a cabo automáticamente.

- Calibración automática:

En el display aparece el valor de la solución tampón, introducir la sonda en el frasco, pulsando la tecla  en el display aparece el conteo al revés de los 60 segundos necesarios para completar la calibración. Si la cantidad de

la alineación fuera inferior al 50%, en el display aparece un error, pulsando la tecla  se sale de la calibración (después de 4 segundos la bomba sale automáticamente), si la cantidad fuera superior al 50% el valor se visualiza



en el display y pulsando la tecla  se solicita la solución tampón con pH 4 ó 9; ahora el procedimiento es igual al anterior.



- Calibración manual:

Cuando en el display aparece el valor de la solución tampón, introducir la sonda en el frasco, pulsando la tecla

 en el display aparece el conteo al revés de los 60 segundos necesarios para completar la calibración. Si la

cantidad de la alineación fuera inferior al 50% en el display aparece un error, pulsando la tecla  se sale de la calibración (después de 4 segundos la bomba sale automáticamente), si la cantidad fuera superior al 50% el valor

se visualiza en el display y pulsando la tecla  en el display parpadea el valor de pH 7.00, con las teclas 

 se introduce el valor de la solución que se posee; con la tecla  se confirma y se pone en marcha el procedimiento de calibración como anteriormente.

Menú calibración Potencial Redox (O.R.P.)

Pulsando la tecla CAL por tres segundos se entra en el menú calibración, si en programación la calibración ha sido excluida, en el display aparece:

Calibration
Off

Si la calibración está activa:

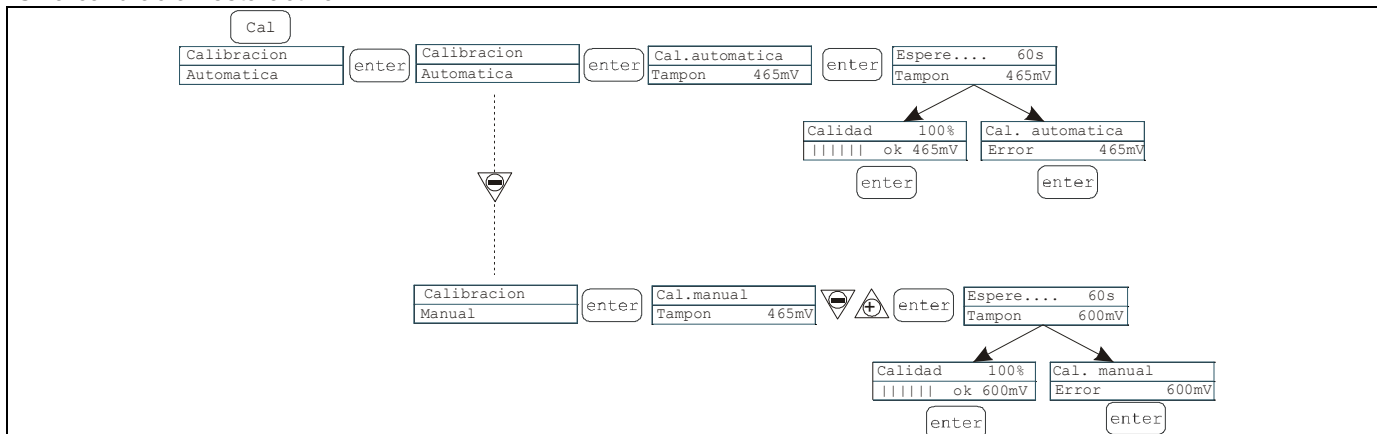

Es posible elegir el modo automático o manual.



- Calibración automática:

En el display aparece el valor de la solución tampón, introducir la sonda en el frasco, pulsando la tecla  en el display aparece el conteo al revés de los 60 segundos necesarios para completar la calibración. Si la cantidad de

la alineación fuera inferior al 50% en el display aparece un error, pulsando la tecla  se sale de la calibración (después de 4 segundos la bomba sale automáticamente), si la cantidad fuera superior al 50% el valor se visualiza





en el display y pulsando la tecla  se termina el procedimiento.

- Calibración manual:

En el display aparece el valor de la solución tampón, introducir la sonda en el frasco, pulsando la tecla  en el display parpadea el valor de 465 mV; introducir la sonda en la solución, después con las teclas  

visualizar el valor de la solución, con la tecla  confirmar y poner en marcha el procedimiento de calibración como anteriormente.











Alarmas

Visualización	Causa	Interrupción				
Led Alarma fijo Mensaje Lev parpadeante Ej: <table border="1" style="display: inline-table; vertical-align: middle;"><tr><td>Man</td><td></td></tr><tr><td>Lev</td><td>P100%</td></tr></table>	Man		Lev	P100%	Alarma de final del nivel sin interrupción del funcionamiento de la bomba.	Reestablecer el nivel del líquido.
Man						
Lev	P100%					
Led Alarma fijo Mensajes Lev y Stop parpadeantes Ej: <table border="1" style="display: inline-table; vertical-align: middle;"><tr><td>Man</td><td></td></tr><tr><td>Lev Stop</td><td>P100%</td></tr></table>	Man		Lev Stop	P100%	Alarma de final del nivel con interrupción del funcionamiento de la bomba.	Reestablecer el nivel del líquido.
Man						
Lev Stop	P100%					
Mensaje Mem parpadeante Ej: <table border="1" style="display: inline-table; vertical-align: middle;"><tr><td>1:n</td><td>6</td></tr><tr><td>Mem</td><td></td></tr></table>	1:n	6	Mem		La bomba recibe uno o más impulsos durante la dosificación con la función <i>memory</i> en OFF.	Pulsar la tecla 
1:n	6					
Mem						
Mensaje Mem parpadeante Ej: <table border="1" style="display: inline-table; vertical-align: middle;"><tr><td>1:n</td><td>M 6</td></tr><tr><td>Mem</td><td></td></tr></table>	1:n	M 6	Mem		La bomba recibe uno o más impulsos durante la dosificación con la función <i>memory</i> en ON.	Cuando la bomba termina de recibir los impulsos externos devuelve los golpes memorizados.
1:n	M 6					
Mem						
Led Alarma fijo Mensaje Flw parpadeante Ej: <table border="1" style="display: inline-table; vertical-align: middle;"><tr><td>Man</td><td>F</td></tr><tr><td>Flw</td><td>P100%</td></tr></table>	Man	F	Flw	P100%	Alarma de flujo activa, la bomba no ha recibido el número de señales programadas por el sensor de flujo.	Pulsar la tecla 
Man	F					
Flw	P100%					
Ej: <table border="1" style="display: inline-table; vertical-align: middle;"><tr><td>Parameter Error</td><td></td></tr><tr><td>PROG to default</td><td></td></tr></table>	Parameter Error		PROG to default		Error de comunicación con la eeprom.	Pulsar la tecla  para reestablecer los parámetros de <i>default</i> .
Parameter Error						
PROG to default						
Mensaje "OFA" parpadeante Mensaje "Stop" parpadeante Ej: <table border="1" style="display: inline-table; vertical-align: middle;"><tr><td>High</td><td>475 mV OFA</td></tr><tr><td>Stop</td><td>P 75%</td></tr></table>	High	475 mV OFA	Stop	P 75%	Alarma O.F.A.	Pulsar la tecla  para bloquear el parpadeo del mensaje Stop, pulsar otra vez la tecla para volver a poner en marcha la bomba.
High	475 mV OFA					
Stop	P 75%					
Mensaje "Alm" parpadeante Ej: <table border="1" style="display: inline-table; vertical-align: middle;"><tr><td>High</td><td>475 mV Alm</td></tr><tr><td>P</td><td>75%</td></tr></table>	High	475 mV Alm	P	75%	El valor leído por la sonda está fuera del <i>range</i> de la banda de alarma programada.	Controlar que el parámetro "Banda Alarma" esté programado correctamente en programación.
High	475 mV Alm					
P	75%					
Mensaje "Cal" parpadeante Ej: <table border="1" style="display: inline-table; vertical-align: middle;"><tr><td>High</td><td>475 mV Cal</td></tr><tr><td>P</td><td>75%</td></tr></table>	High	475 mV Cal	P	75%	Alarma de la sonda no calibrada.	Realizar el procedimiento de calibración de la sonda.
High	475 mV Cal					
P	75%					

OPTIMA PLUS

Panneau de contrôle



	Accès au menu de programmation
	Pendant la phase de fonctionnement de la pompe: si cette touche est enfoncée elle affiche à des intervalles réguliers les valeurs programmées; si elle est enfoncée en même temps que les touches   elle augmente ou réduit une valeur dépendant du mode de fonctionnement choisi. Au cours de la programmation, elle fait fonction de "enter", c'est-à-dire qu'elle confirme l'entrée dans les différents niveaux de menu et les modifications à l'intérieur de ces derniers.
	Fait démarrer et met à l'arrêt la pompe. Dans les conditions d'alarme de niveau (unique fonction d'alarme), de flux et de mémoires actives, elle désactive la signalisation sur l'afficheur
	Pour "quitter" ces différents niveaux de menu. Avant de quitter définitivement la programmation, on accède à la demande d'enregistrement des modifications
	Menu de calibrage
	Fait défiler les menus vers le haut ou augmente les valeurs numériques à modifier. En mode de fonctionnement Batch, elle peut faire démarrer le dosage.
	Fait défiler les menus vers le bas, ou réduit les valeurs numériques à modifier.
	Led verte clignotante pendant le dosage.
	Led rouge qui s'allume dans les différentes situations d'alarme



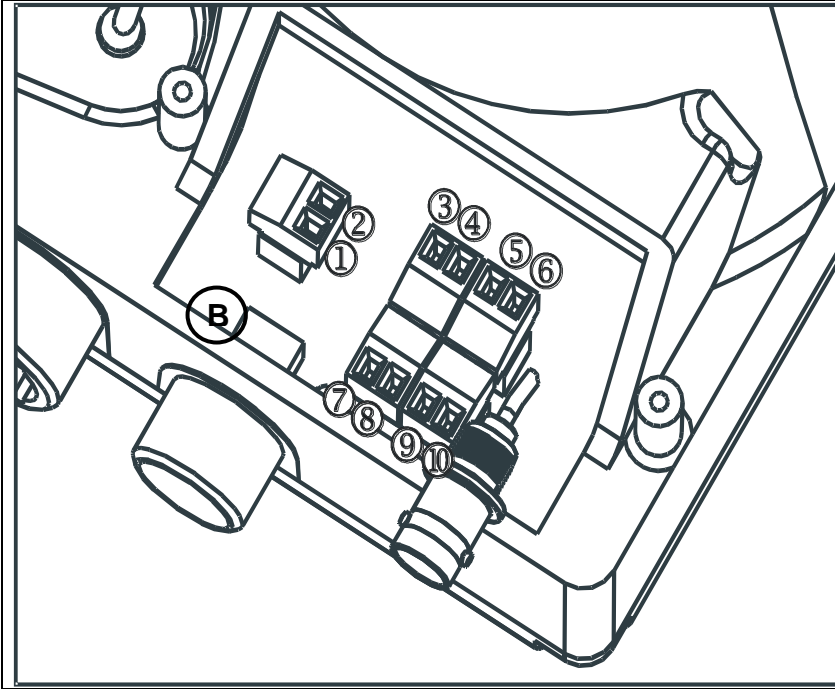

Connexions électriques

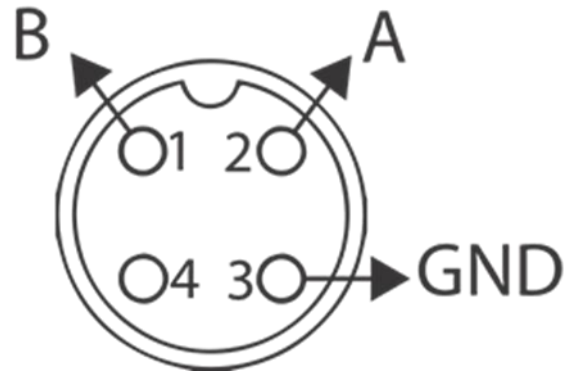

1	Relais Alarme	
2		
3	Pole +	Sortie 4-20 mA max 500ohm
4	Pole -	
5	Entrée commande à distance (start-stop)	
6		
7	Entrée sonde de température	
8		
9	Entrée capteur de débit	
10		
B	Entrée sonde de niveau	

Connexion ModBus	
Pin N°	Description
1	T+R+
2	T-R-
3	GND
4	Non utilisé



Appuyer sur la touche  pendant plus de trois secondes pour allumer la programmation. Avec les touches  il est possible de faire défiler les options du menu, la touche  permet d'accéder aux modifications. La pompe est programmée en usine en mode constant. La pompe reprend automatiquement le mode de fonctionnement après 1 minute de non-activité. Dans ce cas, les données éventuellement introduites ne sont pas enregistrées. La touche  permet de quitter les niveaux de la programmation. À la sortie de la programmation, l'afficheur visualise:

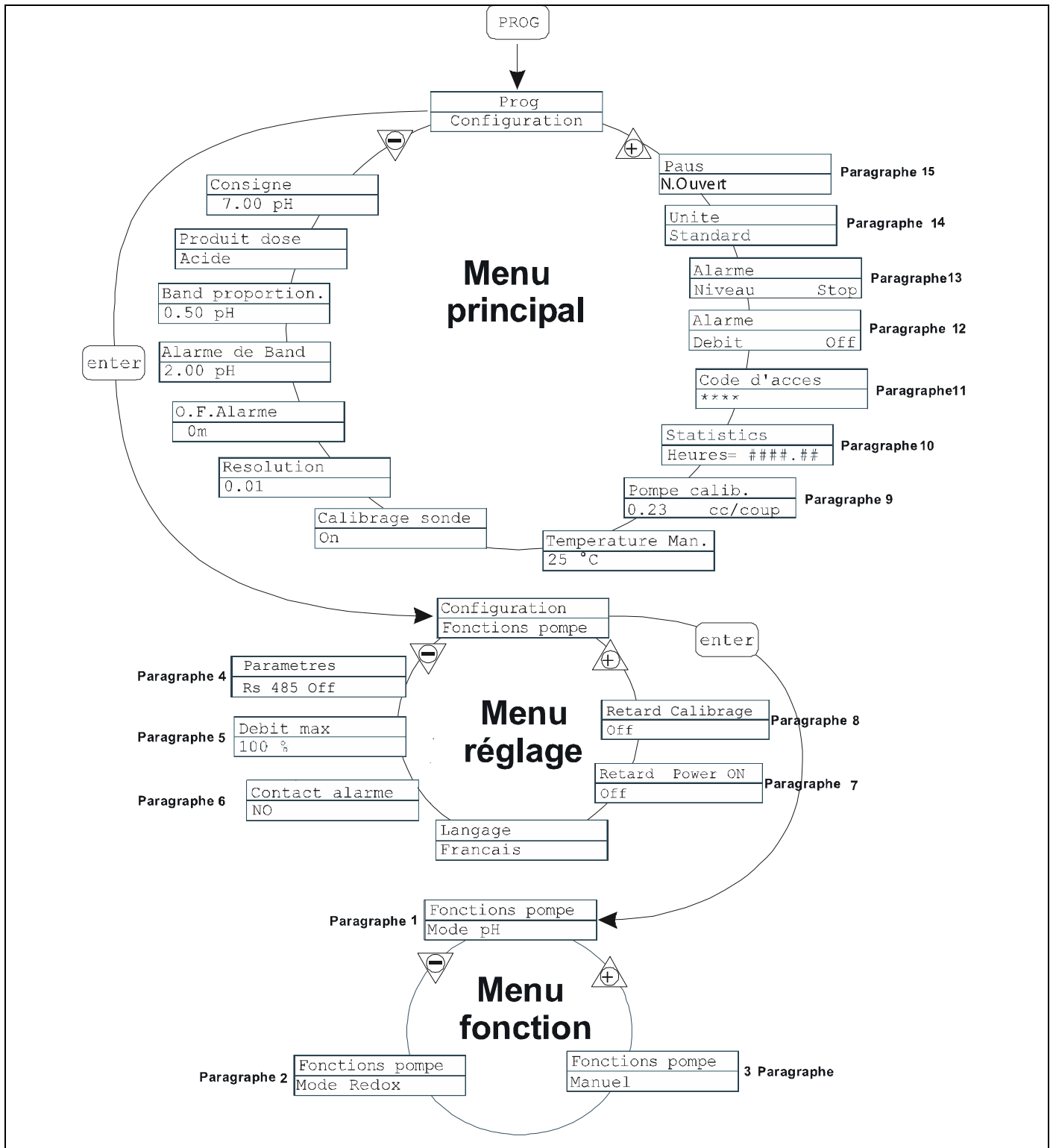

Programmation de la langue

Programmation	Fonctionnement
	<p>Permet de sélectionner la langue, la pompe est programmée en usine en anglais.</p> <p>Appuyer sur pour accéder à la modification, puis sur les touches pour programmer la valeur. La touche confirme et permet de retourner au menu principal.</p>

Paragraphe 1 – Dosage manuel

Programmation	Fonctionnement
	<p>La pompe travaille en mode constant. Le débit est réglé manuellement en appuyant simultanément sur les touches pour augmenter le débit. ou sur les touches pour le réduire.</p>

Affichage pendant le fonctionnement	Affichage lors de la programmation (touche MODE)

Paragraphe 2 – Dosage proportionnel à la mesure du pH (programmation d'usine)

Programmation	Fonctionnement
<div style="text-align: center;"> </div>	<p>La pompe mesure et contrôle la valeur de pH d'une solution, en programmant dans l'ordre : point de consigne, type de point de consigne, bande proportionnelle et bande d'alarme.</p> <p>Type point de consigne : acide</p> <p>Type point de consigne : alcalin</p> <p>Il est en outre possible de programmer :</p> <ul style="list-style-type: none"> - Le temps O.F.A. (Over Feed Alarm) en minutes soit un temps au-delà duquel, si la mesure du pH n'arrive pas au point de consigne, un signal d'alarme se déclenche. - La résolution de la mesure (1 ou 2 chiffres décimaux) - Désactivation/activation de la procédure de calibrage - Valeur manuelle de la température en °C (usine) ou °F <p>La fréquence maximale est modifiable pendant la phase de fonctionnement en appuyant simultanément sur les touches pour augmenter le débit ou sur les touches pour le réduire.</p>

Affichage pendant le fonctionnement	Affichage lors de la programmation (touche MODE)
<div style="display: flex; justify-content: space-between;"> <div style="border: 1px solid black; padding: 5px; width: 30%;"> <p>Type P.de consigne; Acide/Alcalin</p> </div> <div style="border: 1px solid black; padding: 5px; width: 30%;"> <p>État capteur de FLUX</p> </div> <div style="border: 1px solid black; padding: 5px; width: 30%;"> <p>Valeur de mesure du pH.</p> </div> </div> <div style="text-align: center; margin: 10px 0;"> <div style="border: 1px solid black; padding: 5px; display: inline-block;"> Alca F 7.00pH Niv Stop P100% </div> </div> <div style="display: flex; justify-content: space-between;"> <div style="border: 1px solid black; padding: 5px; width: 30%;"> <p>Alarmes et états</p> <ul style="list-style-type: none"> • Cal = calibrage non effectué • Lev = Alarme niveau • Flw = Alarme flux • Alm = Mesure hors Bande alarme • OFA = Alarme O.F.A. </div> <div style="border: 1px solid black; padding: 5px; width: 30%;"> <p>État de la pompe</p> <ul style="list-style-type: none"> • Vide=pompe au démarrage • Stop = pompe arrêtée • Paus = pompe en pause </div> <div style="border: 1px solid black; padding: 5px; width: 30%;"> <p>Valeur du dosage en cours (dépend de l'unité de mesure sélectionnée)</p> <ul style="list-style-type: none"> • Pourcentage, Fréquence, l/h, Gph, ml/m </div> </div>	<p style="text-align: center;">Affiche dans l'ordre:</p> <ul style="list-style-type: none"> • SP = valeur Point de consigne • BP = valeur Bande Proportionnelle • BA = valeur Bande Alarme • OFA = Valeur O.F.A. • TEMP=Valeur Température <div style="text-align: center; margin: 10px 0;"> <div style="border: 1px solid black; padding: 5px; display: inline-block;"> SP 7.00pH 4.50pH P100% </div> </div> <p style="text-align: center;">Valeur de la mesure.</p> <div style="text-align: center; margin: 10px 0;"> <div style="border: 1px solid black; padding: 5px; display: inline-block;"> Valeur du dosage maximal programmé (dépend de l'unité de mesure sélectionnée) </div> <ul style="list-style-type: none"> • Pourcentage, Fréquence, l/h, Gph, ml/m </div>

Paragraphe 3 – Dosage proportionnel à la mesure du potentiel Redox (O.R.P.)

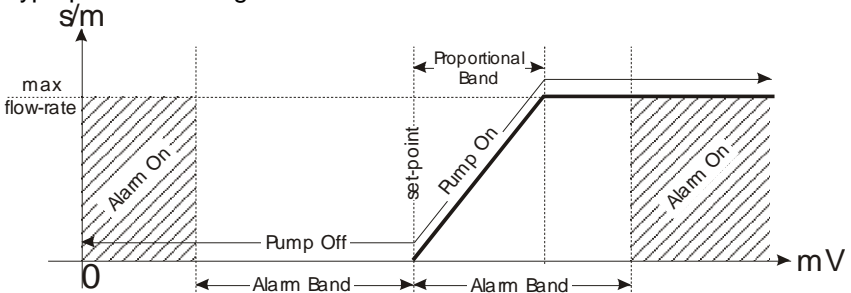
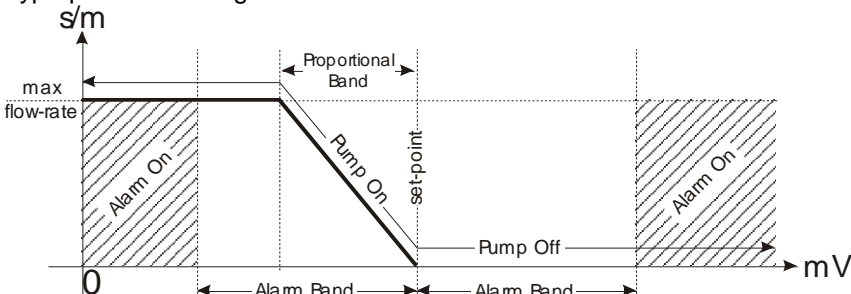
Programmation	Fonctionnement
<p>PROG Configuration enter Configuration Fonctions pompe enter Fonctions pompe Mode Redox enter Consigne 560 mV enter Dosage Haute enter Band proportion. 50 mV enter Alarme de Band 200 mV enter O.F.Alarme 0m enter Calibrage sonde On enter</p>	<p>La pompe mesure et contrôle la valeur de pH d'une solution, en programmant dans l'ordre : point de consigne, type de point de consigne, bande proportionnelle et bande d'alarme.</p> <p>Type point de consigne : maximal</p>  <p>Type point de consigne : minimal</p>  <p>Il est en outre possible de programmer :</p> <ul style="list-style-type: none"> - Le temps O.F.A. (Over Feed Alarm) en minutes soit un temps au-delà duquel, si la mesure du pH n'arrive pas au point de consigne, un signal d'alarme se déclenche. - La résolution de la mesure (1 ou 2 chiffres décimaux) - Désactivation/activation de la procédure de calibrage <p>La fréquence maximale est modifiable pendant la phase de fonctionnement en appuyant simultanément sur les touches pour augmenter le débit ou sur les touches pour le réduire.</p>

Affichage pendant le fonctionnement	Affichage lors de la programmation (touche MODE)
<p>État capteur de FLUX</p> <p>Valeur mesure du potentiel Redox.</p> <p>Haut F 560mV Niv Stop P100%</p> <p>Valeur du dosage en cours (dépend de l'unité de mesure sélectionnée)</p> <ul style="list-style-type: none"> • Pourcentage, Fréquence, l/h, Gph, ml/m <p>État de la pompe</p> <ul style="list-style-type: none"> • Vide=pompe au démarrage • Stop = pompe arrêtée • Paus = pompe en pause <p>Alarmes et états</p> <ul style="list-style-type: none"> • Cal = calibrage non effectué • Lev = Alarme niveau • Flw = Alarme flux • Alm = Mesure hors Bande alarme • OFA = Alarme O.F.A. 	<p>Affiche dans l'ordre</p> <ul style="list-style-type: none"> • SP = valeur Point de consigne • BP = valeur Bande Proportionnelle • BA = valeur Bande Alarme • OFA = Valeur O.F.A. <p>Valeur de la mesure.</p> <p>SP 560mV 450mV P100%</p> <p>Valeur du dosage maximal programmé (dépend de l'unité de mesure sélectionnée)</p> <ul style="list-style-type: none"> • Pourcentage, Fréquence, l/h, Gph, ml/m

Paragraphe 4 – RS485 Parametres

Programming	Operation
	<p>Cela permet d' activer (désactiver) la communication ModBus RS485 (par défaut) .</p> <p>Si Active dans le menu montrera les éléments suivants :</p> <ul style="list-style-type: none"> -BaudRate: La valeur de la vitesse de transmission, il est possible de régler comme : 2400, 4800, 9600 (valeur par défaut), 19200 or 38400. - Parity : La valeur du bit de parité, il est possible de régler comme: Paire (valeur par défaut), Impaire ou Aucune -Address: Il est possible de régler l'adresse de l'appareil de 1 (valeur par défaut) à 247. -Timeout: Il est possible de définir le délai de chien de garde , si Off est désactivé sinon il est possible de définir un temps de 1 à 65535 secondes (désactivé par défaut) -Hardware Reset: Il est possible de définir la communication Watchdog comme réinitialisation matérielle , Com . Reset, Arrêt Posologie et WDG Alarme (WDG alarme par défaut) . <p>Des changements peuvent être effectués en appuyant sur la key, puis en utilisant la keys pour définir la nouvelle valeur .</p> <p>Presse pour confirmer et revenir au menu principal.</p>

Paragraphe 5 – Programmation débit maximal

Programmation	Fonctionnement
	<p>Permet de programmer le débit maximal pouvant être atteint par la pompe et le mode programmé (% ou fréquence) devient l'affichage du débit dans l'unité de mesure standard. Appuyer sur pour accéder à la modification, puis avec les touches programmer la valeur. Avec confirmer et retourner au menu principal.</p>

Paragraphe 6 – Programmation du relais d'alarme

Programmation	Fonctionnement
	<p>Sert à programmer le relais d'alarme en l'absence d'une situation d'alarme, si ouvert (usine) ou fermé.</p> <p>Appuyer sur pour accéder à la modification puis avec les touches programmer la valeur. Avec confirmer et retourner au menu principal.</p>

Paragraphe 7 – Configuration Retard Power On

Programmation	Fonctionnement
	<p>Permet de configurer un retard du fonctionnement de la pompe lors de son allumage. Ce retard prend effet uniquement si la pompe est éteinte et rallumée en coupant l'alimentation.</p> <p>La configuration peut être désactivée avec Off (usine) ou alors, il est possible de configurer un retard de 1 à 60 minutes.</p> <p>Avec le retard actif, durant le temps configuré, les leds d'alarme et d'impulsion clignotent en même temps (1 sec On – 1 sec Off) et l'écran affiche un compte à rebours en secondes. Si la pompe est en état d'Arrêt, seules les leds clignotantes s'affichent. Durant le temps de retard la fonction peut être désactivée en accédant au menu et en configurant le temps sur Off.</p> <p>En appuyant sur l'on accède à la modification, ensuite avec les touches l'on configure la valeur. Avec l'on confirme et retourne au menu principal.</p>

Paragraphe 8 – Configuration Retard Calibrage

Programmation	Fonctionnement
	<p>Permet de programmer un retard du fonctionnement de la pompe après le calibrage de la sonde (Redox ou pH).</p> <p>La configuration peut être désactivée avec Off (usine) ou alors, il est possible de configurer un retard de 1 à 60 minutes.</p> <p>Avec le retard actif, durant le temps configuré, les leds d'alarme et d'impulsion clignotent en même temps (1 sec On – 1 sec Off) et l'écran affiche un compte à rebours en secondes. Si la pompe est en état d'Arrêt, seules les leds clignotantes s'affichent. Durant le temps de retard la fonction peut être désactivée en accédant au menu et en configurant le temps sur Off.</p> <p>En appuyant sur l'on accède à la modification, ensuite avec les touches l'on configure la valeur. Avec l'on confirme et retourne au menu principal.</p>

Paragraphe 9 – Calibrage débit

Programmation	Fonctionnement
	<p>Le menu principal affiche la valeur de cc par coup en mémoire. Il est possible de calibrer en deux modes :</p> <p>MANUEL – insérer manuellement la valeur en cc par coup avec les touches et confirmer avec </p> <p>AUTOMATIQUE – la pompe exécute 100 coups qui sont activés avec la touche , une fois terminés, insérer la quantité aspirée par la pompe avec les touches et confirmer avec .</p> <p>La donnée insérée sera utilisée dans les calculs des débits</p>

Paragraphe 10 – Statistiques

Programmation	Fonctionnement
	<p>Le menu principal affiche les heures de fonctionnement de la pompe, appuyer sur pour accéder aux autres statistiques.</p> <ul style="list-style-type: none"> - Strokes = nombre de coups exécutés par la pompe - Q.ty(L) = quantité dosée par la pompe exprimée en litres; cette donnée est calculée d'après la valeur cc/stroke en mémoire - Power = nombre de démarrages de la pompe <p>- Reset = les touches permettent de réinitialiser les compteurs (YES) ou non (NO), appuyer sur pour confirmer.</p> <p>La pression de permet de retourner au menu principal.</p>

Paragraphe 11 – Password

Programmation	Fonctionnement
	<p>Entrer le mot de passe pour entrer dans la programmation et voir toutes les valeurs programmées, le mot de passe sera demandé à chaque tentative de modification</p> <p>La ligne clignotante indique le nombre modifiable, avec la touche sélectionner le nombre (de 1 à 9), avec la touche sélectionner le nombre à modifier puis avec la touche confirmer. En programmant "0000" (défaut), le mot de passe est exclu.</p>

Paragraphe 12 – Alarme de flux

Programmation	Fonctionnement
	<p>Permet d'activer (Désactiver) le capteur de flux.</p> <p>Une fois activé (On) appuyer sur la touche pour accéder à la demande de combien de signaux la pompe attend avant de déclencher l'état d'alarme. En appuyant sur le nombre clignote, puis avec les touches programmer la valeur. Avec confirmer. Appuyer sur pour retourner au menu principal</p>

Paragraphe 13 – Alarme de niveau

Programmation	Fonctionnement
	<p>Permet de programmer la pompe lorsque l’alarme du capteur de niveau s’active, à savoir si bloquer le dosage (Stop) ou si tout simplement activer la signalisation d’alarme sans bloquer le dosage.</p> <p>Appuyer sur pour accéder à la modification. Puis avec les touches programmer le type d’alarme.</p> <p>Avec confirmer. Appuyer sur pour retourner au menu principal.</p>

Paragraphe 14 – Unité Affichage débit

Programmation	Fonctionnement
	<p>Permet de programmer l’unité de mesure du dosage sur l’afficheur.</p> <p>Appuyer sur pour accéder à la modification, puis appuyer sur pour programmer le type d’unité de mesure, L/h (Litres/heure), Gph (Gallons/heure), ml/m (millilitres/minute) ou standard (% ou fréquence selon la programmation), Appuyer sur pour confirmer et retourner au menu principal</p>

Paragraphe 15 – Programmation Pause

Programmation	Fonctionnement
	<p>Entrée signal pour mettre la pompe en pause. Le système est réglé d’usine en Normalement Ouvert.</p> <p>Appuyer sur pour accéder à la modification puis avec les touches programmer la valeur (N. OUVERT ou N. FERME’).</p> <p>Avec confirmer et retourner au menu principal.</p>

Menu Calibrage pH

Appuyer sur la touche CAL x 3 secondes pour entrer dans le menu calibrage, si lors de la programmation, le calibrage a été exclu, l'afficheur visualise :

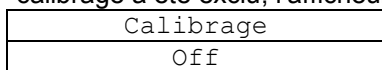

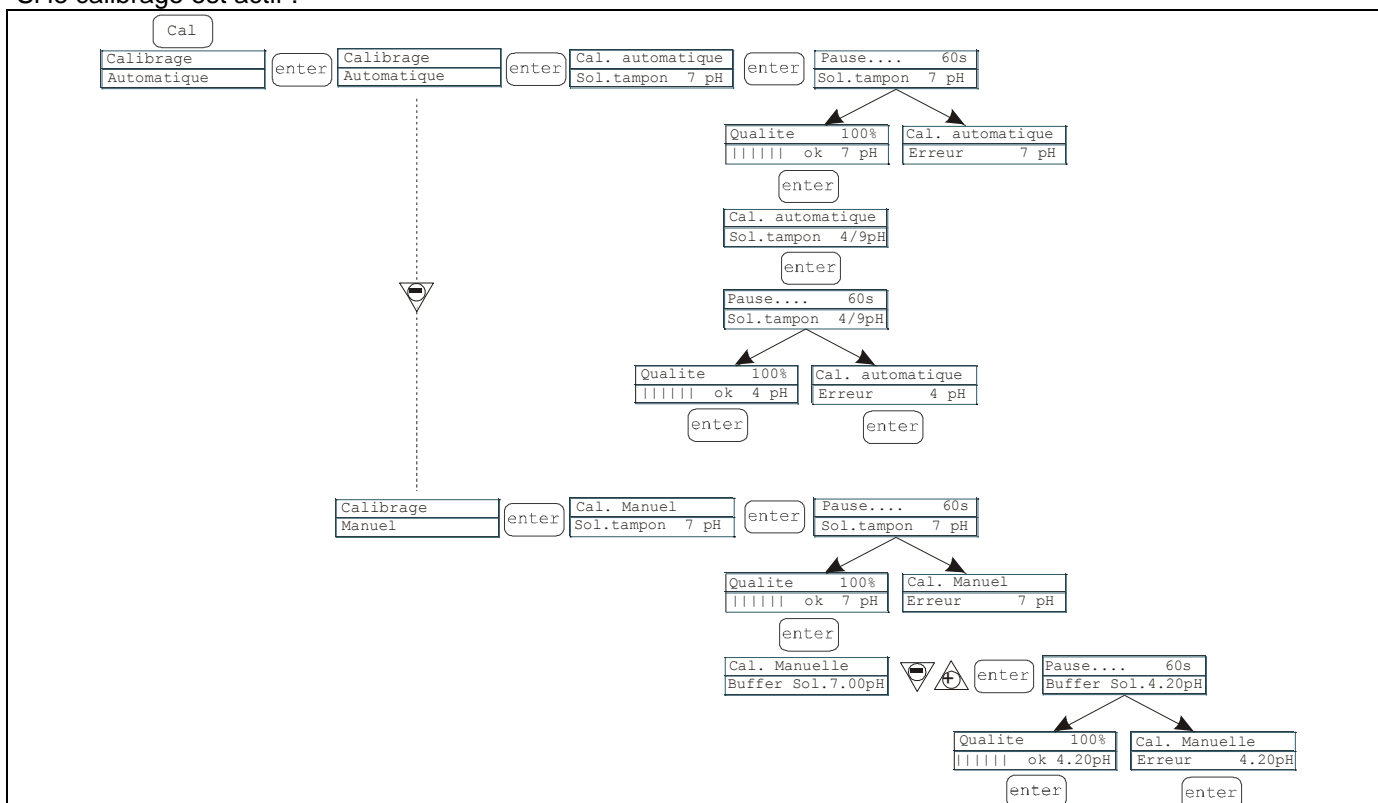

Si le calibrage est actif :



Il est possible de choisir le mode automatique ou manuel, dans les deux cas le calibrage à pH 7 se fait automatiquement.

- Calibrage automatique :

L'afficheur visualise la valeur de la solution tampon, insérer la sonde dans le flacon, appuyer sur  pour que le compte à rebours des 60 secondes nécessaires pour compléter le calibrage s'affiche.



Si la qualité de l'alignement est inférieure à 50% l'erreur s'affiche et appuyer sur  pour quitter le calibrage (après 4 secondes la pompe sort automatiquement), si la qualité est supérieure à 50%, la valeur s'affiche et en appuyant

sur  on obtient la demande de la solution tampon à pH 4 ou 9 ; à ce point la procédure est la même que la précédente,

- Calibrage manuel :

lorsque sur l'afficheur visualise la valeur de la solution tampon, insérer la sonde dans le flacon, appuyer sur  pour que le compte à rebours des 60 secondes nécessaires pour compléter le calibrage s'affiche.

Si la qualité de l'alignement est inférieure à 50% l'erreur s'affiche et appuyer sur  pour quitter le calibrage (après 4 secondes la pompe sort automatiquement), si la qualité est supérieure à 50%, la valeur s'affiche et en appuyant

sur  on obtient le clignotement de la valeur de pH 7.00, avec les touches   introduire la valeur de la

solution possédée puis appuyer sur  pour confirmer et faire démarrer la procédure de calibrage comme auparavant.

Menu Calibrage Potentiel Redox (O.R.P.)

Appuyer sur la touche CAL x 3 secondes pour entrer dans le menu de calibrage, si lors de la programmation, le calibrage a été exclu, l'afficheur visualise:

Calibrage
Off

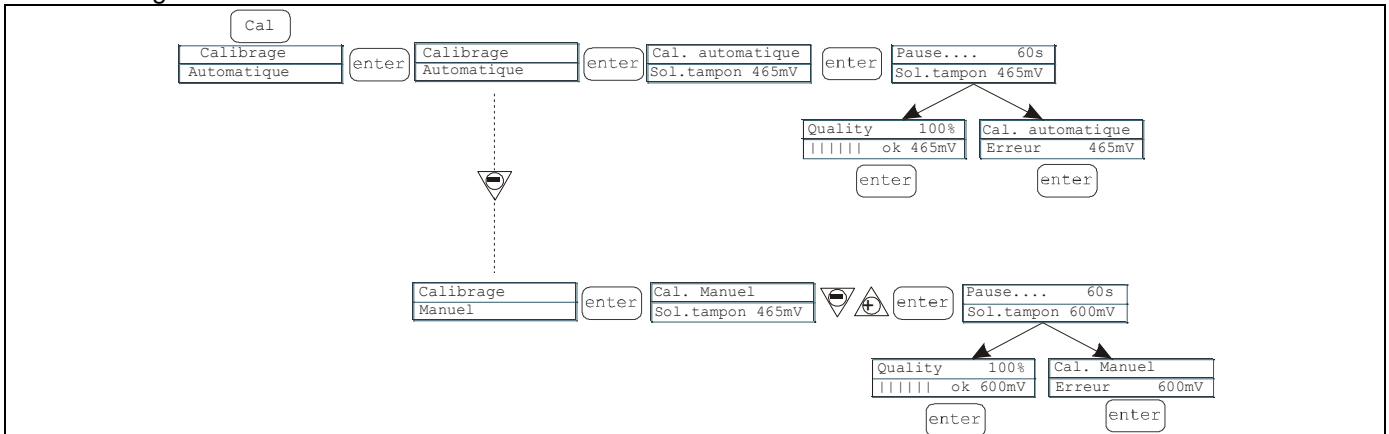

Si le calibrage est actif:







Il est possible de choisir le mode automatique ou manuel.

- Calibrage automatique:





La valeur de la solution tampon s'affiche, insérer la sonde dans le flacon, appuyer sur  pour que le compte à rebours des 60 secondes nécessaires pour compléter le calibrage s'affiche.

Si la qualité de l'alignement est inférieure à 50% l'erreur s'affiche et appuyer sur  pour quitter le calibrage (après 4 secondes la pompe sort automatiquement), si la qualité est supérieure à 50%, la valeur est affichée et appuyer sur  pour compléter la procédure.

- Calibrage manuel:

la valeur de la solution tampon s'affiche, insérer la sonde dans le flacon, en appuyant sur  on obtient le clignotement sur l'afficheur de la valeur de 465mV, insérer la sonde dans la solution puis appuyer sur les touches   pour visualiser la valeur de la solution possédée puis appuyer sur  pour confirmer et faire démarrer la procédure de calibrage comme auparavant.











Alarmes

Affichage	Causa	Interruption						
Led Alarme fixe Message Lev clignotant Ex: <table border="1" style="display: inline-table; vertical-align: middle;"><tr><td>Man</td><td></td></tr><tr><td>Lev</td><td>P100%</td></tr></table>	Man		Lev	P100%	Alarme fin de niveau, sans interruption du fonctionnement de la pompe.	Rétablissement du niveau du liquide.		
Man								
Lev	P100%							
Led Alarme fixe Message Lev et Stop clignotant Ex: <table border="1" style="display: inline-table; vertical-align: middle;"><tr><td>Man</td><td></td></tr><tr><td>Lev Stop</td><td>P100%</td></tr></table>	Man		Lev Stop	P100%	Alarme fin de niveau, avec interruption du fonctionnement de la pompe.	Rétablissement du niveau du liquide.		
Man								
Lev Stop	P100%							
Message Mem clignotant Ex: <table border="1" style="display: inline-table; vertical-align: middle;"><tr><td>1:n</td><td>6</td></tr><tr><td>Mem</td><td></td></tr></table>	1:n	6	Mem		La pompe reçoit une ou plusieurs impulsions pendant le dosage avec fonction de mémoire sur Off.	Pression de la touche 		
1:n	6							
Mem								
Message Mem clignotant Ex: <table border="1" style="display: inline-table; vertical-align: middle;"><tr><td>1:n</td><td>M</td><td>6</td></tr><tr><td>Mem</td><td></td><td></td></tr></table>	1:n	M	6	Mem			La pompe reçoit une ou plusieurs impulsions pendant le dosage avec fonction de mémoire sur On.	Lorsque la pompe cesse de recevoir les impulsions extérieures, elle rend les coups mémorisés.
1:n	M	6						
Mem								
Led Alarme fixe Message Flw clignotant Ex: <table border="1" style="display: inline-table; vertical-align: middle;"><tr><td>Man</td><td>F</td></tr><tr><td>Flw</td><td>P100%</td></tr></table>	Man	F	Flw	P100%	Alarme de flux actif, la pompe n'a pas reçu le nombre de signaux programmés par le capteur de flux.	Pression de la touche 		
Man	F							
Flw	P100%							
Ex: <table border="1" style="display: inline-table; vertical-align: middle;"><tr><td>Parameter Error</td></tr><tr><td>PROG to default</td></tr></table>	Parameter Error	PROG to default	Erreur de communication avec la Eeprom.	Pression de la touche  pour rétablir les paramètres de défaut.				
Parameter Error								
PROG to default								
Message "OFA" clignotant Message "Stop" clignotant Ex: <table border="1" style="display: inline-table; vertical-align: middle;"><tr><td>High</td><td>475 mV OFA</td></tr><tr><td>Stop</td><td>P 75%</td></tr></table>	High	475 mV OFA	Stop	P 75%	Alarme O.F.A.	Pression de la touche  pour bloquer le clignotement du message Stop, une pression supplémentaire de la touche fait redémarrer la pompe.		
High	475 mV OFA							
Stop	P 75%							
Message "Alm" clignotant Ex: <table border="1" style="display: inline-table; vertical-align: middle;"><tr><td>High</td><td>475 mV Alm</td></tr><tr><td>P</td><td>75%</td></tr></table>	High	475 mV Alm	P	75%	La valeur lue par la sonde est hors de la plage de la bande d'alarme programmée.	Contrôler la programmation correcte du paramètre "Bande Alarme" en programmation.		
High	475 mV Alm							
P	75%							
Message "Cal" alarme Ex: <table border="1" style="display: inline-table; vertical-align: middle;"><tr><td>High</td><td>475 mV Cal</td></tr><tr><td>P</td><td>75%</td></tr></table>	High	475 mV Cal	P	75%	Alarme sonde non calibrée.	Effectuer la procédure de calibrage de la sonde.		
High	475 mV Cal							
P	75%							

OPTIMA PLUS

Pannello di controllo



	Accesso al menu di programmazione
	Durante la fase di funzionamento della pompa: premuto visualizza ciclicamente sul display i valori programmati; Premuto contemporaneamente ai pulsanti   aumenta o decrementa un valore dipendente dalla modalità di funzionamento prescelta. In programmazione svolge la funzione "enter", cioè conferma l'ingresso nei vari livelli di menu e le modifiche all'interno degli stessi.
	Avvia e mette in fase di stop la pompa. Nelle condizioni di allarme di livello (sola funzione allarme), di flusso e memory attive, disattiva la segnalazione sul display.
	Per "uscire" dai vari livelli di menu. Prima di uscire definitivamente dalla programmazione si accede alla richiesta salvataggio delle modifiche.
	Accesso al menu di calibrazione pH/Redox della pompa. Se in modalità Off, il menu di calibrazione non viene attivato. Nella funzione Manuale la calibrazione pH/Redox non è attiva.
	Scorre i menu verso l'alto, oppure incrementa i valori numerici da modificare. Nella modalità Batch può avviare il dosaggio
	Scorre i menu verso il basso, oppure decrementa i valori numerici da modificare.
	Led verde lampeggiante durante il dosaggio
	Led rosso che si accende nelle varie situazioni d'allarme

Collegamenti elettrici

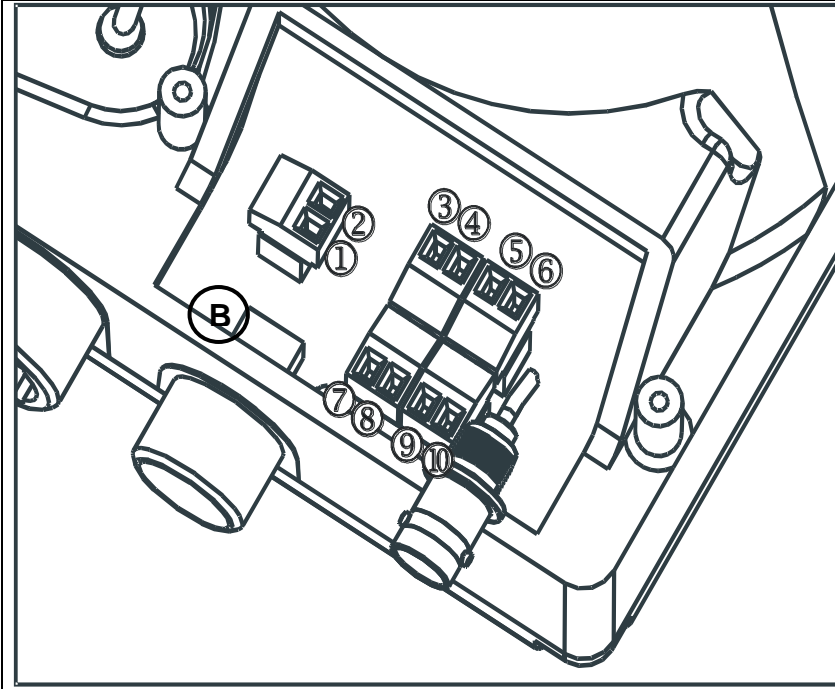



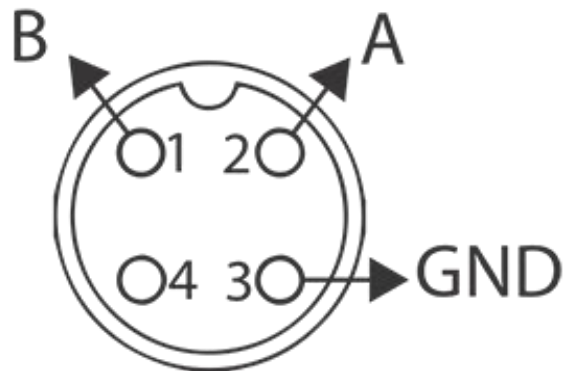

1	Relè d'allarme	
2		
3	Polo +	Uscita 4-20 mA max 500ohm
4	Polo -	
5	Ingresso controllo remoto (start-stop)	
6		
7	Ingresso sonda di temperatura	
8		
9	Ingresso sensore di flusso	
10		
B	Ingresso sonda controllo livello	

Connessione ModBus	
Pin N°	Descrizione
1	T+R+
2	T-R-
3	GND
4	Non utilizzato



Menù di programmazione Optima Plus

Premendo il tasto  per più di tre secondi si accede alla programmazione. Con i tasti   potrete scorrere le voci del menu, con il pulsante  si accede alle modifiche.

Di fabbrica la pompa è programmata in modalità costante. La pompa torna automaticamente nella modalità di funzionamento dopo 1 minuto di non attività. I questo caso dati eventualmente inseriti non vengono salvati.

Con il pulsante  si esce dai livelli della programmazione. All'uscita dalla programmazione il display visualizza:

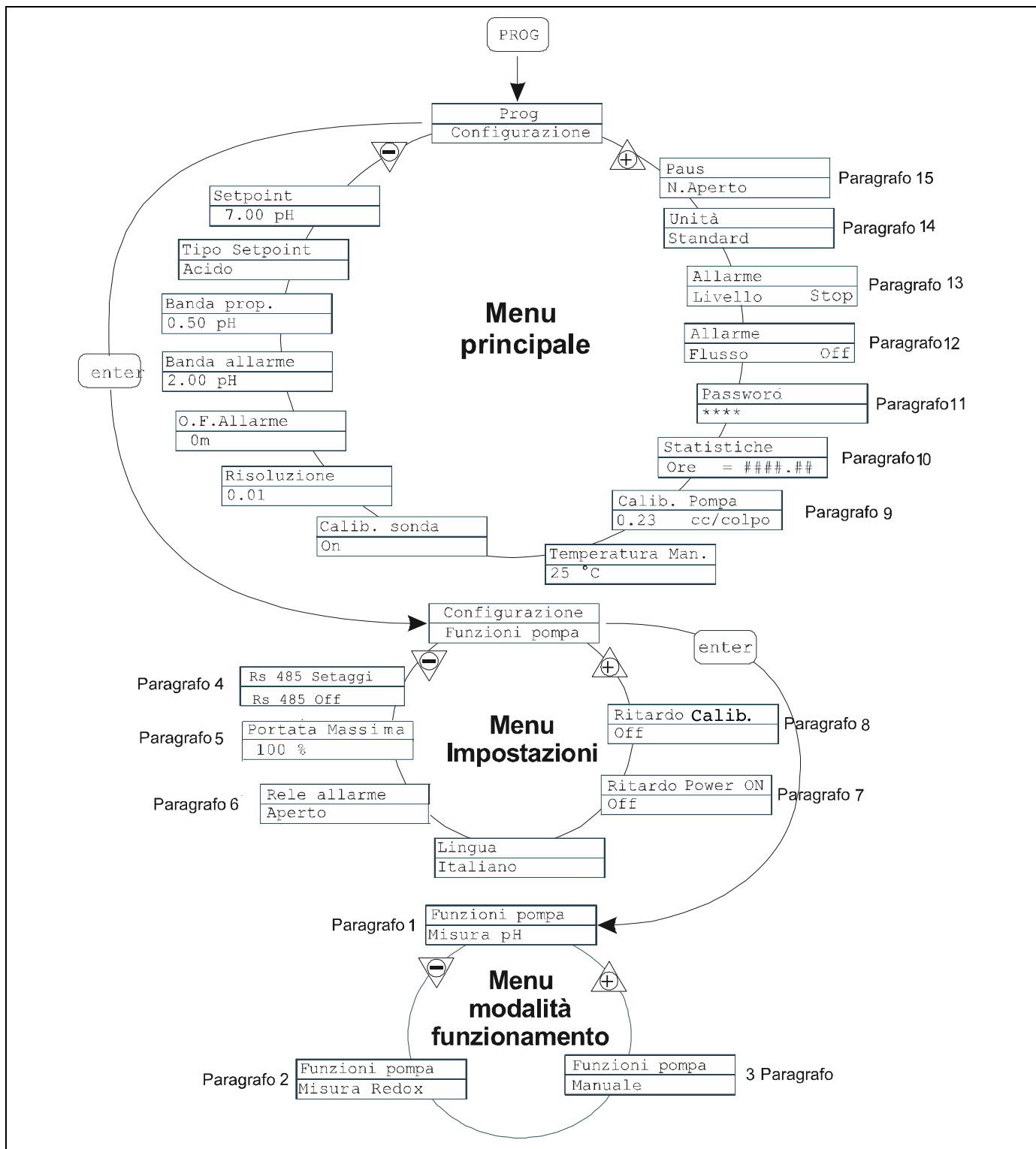
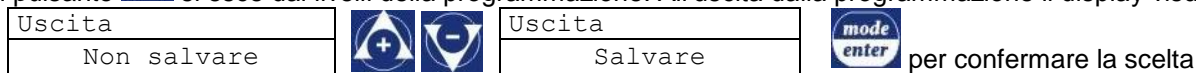

Impostazione lingua

Programmazione	Funzionamento
<pre> graph TD A[PROG] --> B[Configuration] B --> C[Pump Functions] C --> D[Max flow rate PI00%] D --> E[Alarm Relay N.Open] E --> F[Language English] F --> G[] G --> H[] </pre>	<p>Permette di selezionare la lingua, di fabbrica la pompa è impostata in inglese.</p> <p>Premendo si accede alla modifica, quindi con i tasti imposto il valore. Con confermo e torno al menu principale</p>

Paragrafo 1 – Dosaggio Proporzionale alla misura del pH (impostazione di fabbrica)

Programmazione	Funzionamento
<pre> graph TD A[PROG] --> B[Configurazione] B --> C[Funzioni pompa] C --> D[Misura pH] D --> E[Setpoint 7.00 pH] E --> F[Tipo Setpoint Acido] F --> G[Banda prop. 0.50 pH] G --> H[Banda allarme 2.00 pH] H --> I[O.F.Allarme 0m] I --> J[Risoluzione 0.01] J --> K[Calib. sonda On] K --> L[Temperatura Man. 25 °C] L --> M[] M --> N[] </pre>	<p>La pompa misura e controlla il valore di pH di una soluzione, programmando in sequenza: set-point, tipo di set-point, banda proporzionale e banda d'allarme.</p> <p>Tipo set-point: acido</p> <p>Tipo set-point: alcalino</p> <p>Si può inoltre programmare:</p> <ul style="list-style-type: none"> - il tempo O.F.A. (Over Feed Alarm) in minuti, cioè un tempo oltre il quale se la misura del pH non arriva al setpoint, si attiva un segnale d'allarme. - La risoluzione della misura (1 o 2 cifre decimali) - Disattivazione/attivazione della procedura di calibrazione - Valore manuale della temperatura in °C (fabbrica) o °F <p>La frequenza massima è modificabile durante la fase di funzionamento premendo contemporaneamente i tasti per aumentare la portata, oppure i pulsanti per diminuirla.</p>

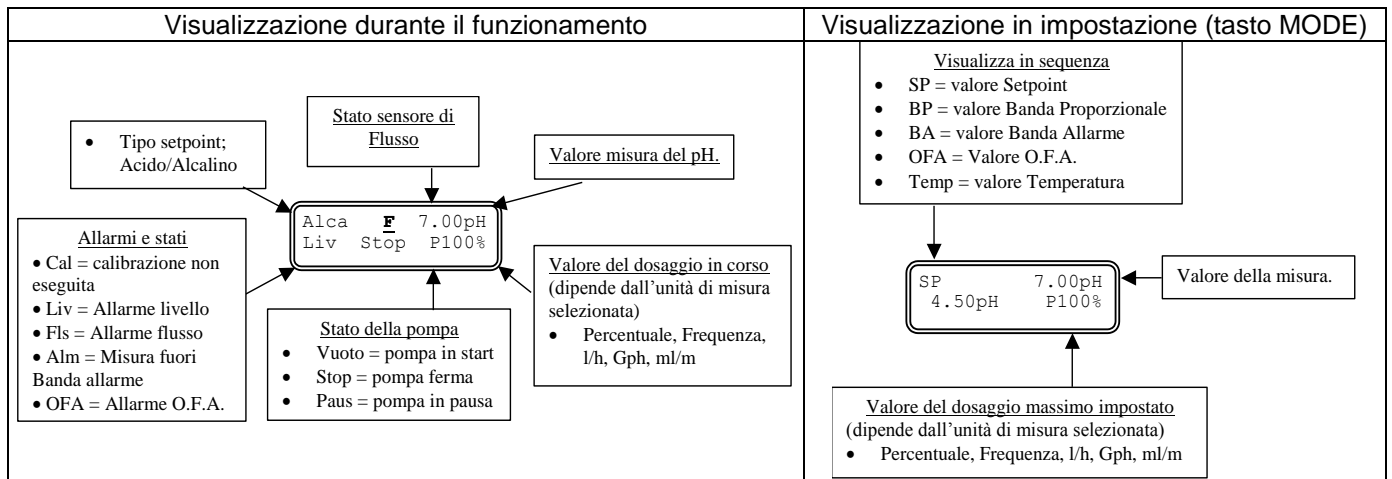

Paragrafo 2 – Dosaggio Proporzionale alla misura del potenziale Redox (O.R.P.)

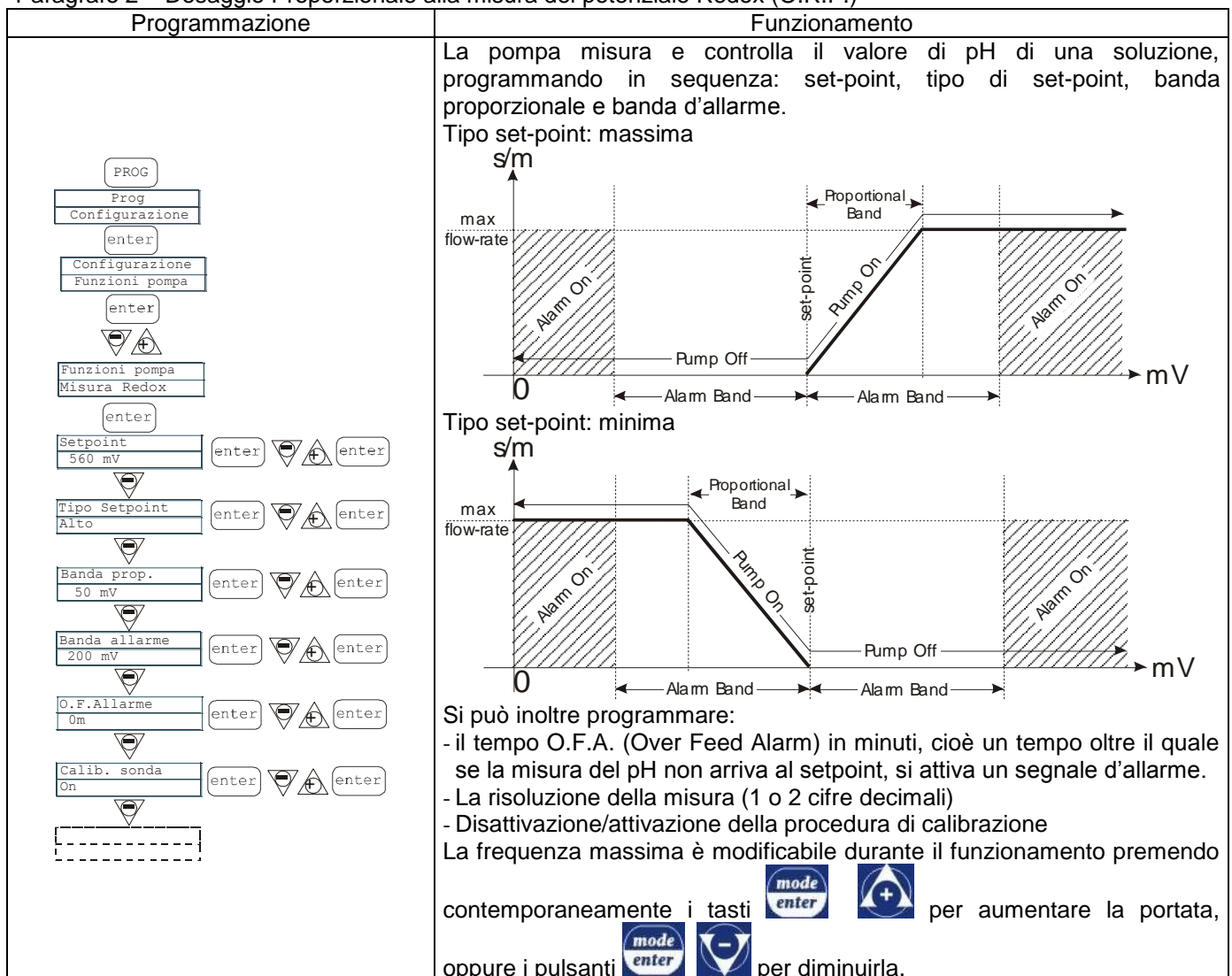

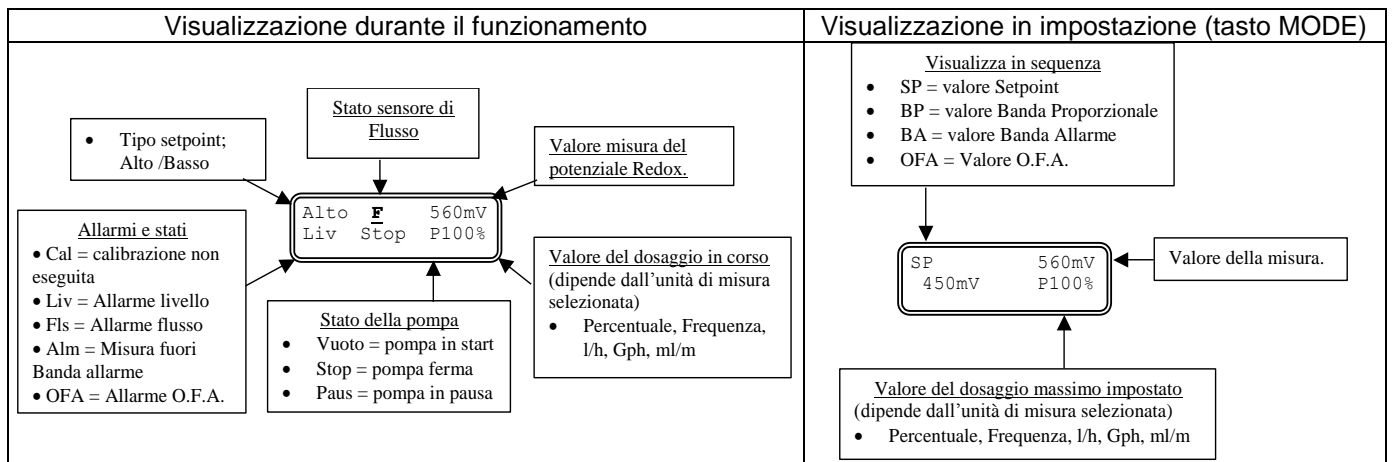

Paragrafo 3 –Dosaggio manuale

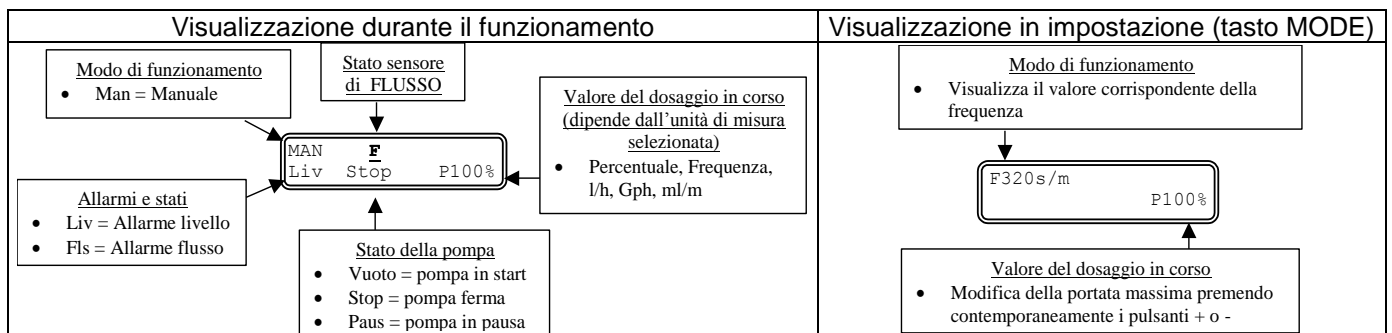
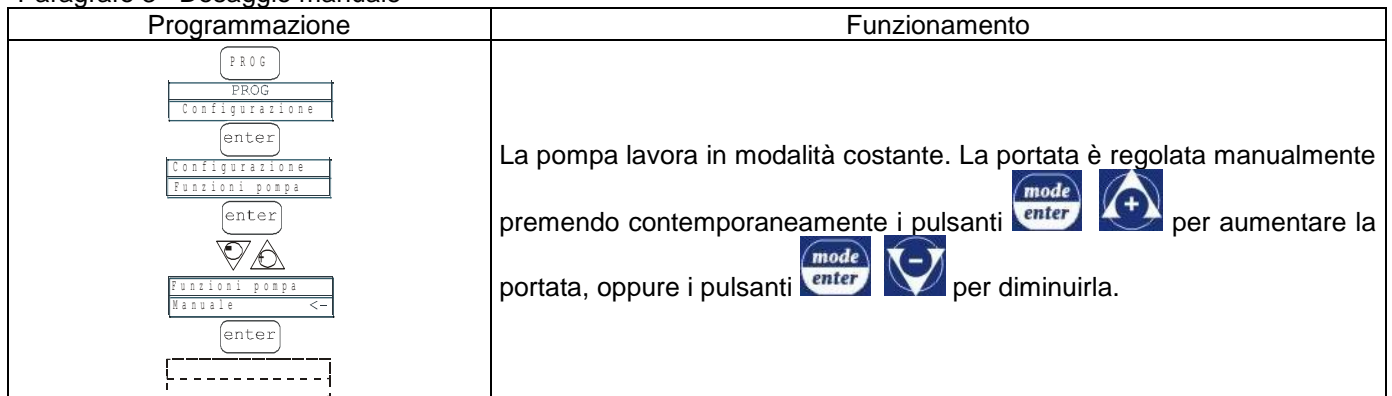

Paragrafo 4 – RS 485 Settaggi

Programming	Operation
	<p>In questo modo è possibile attivare (disattivare) la comunicazione Modbus RS485 (impostazione predefinita) Se attivato il menu mostrerà le seguenti voci:</p> <ul style="list-style-type: none"> -BaudRate: E' possibile settare il BaudRate su 2400, 4800, 9600, 19200 o 38400 (9600 è di Default). -Parità: E' possibile settare Parità come; Even, Odd or No (disabilitato). -Indirizzo: E' possibile settare il valore da 1 a 247 (1 valore di Default). -Timeout: E 'possibile impostare il timeout Watchdog , se Off è attivo, altrimenti è possibile impostare un tempo da 1 a 65535 secondi (disattivata per impostazione predefinita) -Hardware Reset: è possibile impostare la comunicazione watchdog come reset hardware , Com . Reset, arresto Dosaggio e WDG Alarm (allarme WDG impostazione predefinita) <p>Le modifiche possono essere effettuate premendo key, premere keys per impostare nuovi valori. Premere per confermare o per ritornare al menu.</p>





Paragrafo 5 – Impostazione massima portata

Programmazione	Funzionamento
	<p>Permette di impostare la massima portata raggiungibile dalla pompa e la modalità programmata (% o frequenza) diventa la visualizzazione della portata nell'unità di misura standard. Premendo si accede alla modifica, quindi con i tasti imposto il valore. Con confermo e torno al menu principale</p>





Paragrafo 6 – Impostazione relé d'allarme

Programmazione	Funzionamento
	<p>Serve ad impostare il relè di allarme in assenza di situazione d'allarme, se aperto (fabbrica) oppure chiuso.</p> <p>Premendo si accede alla modifica, quindi con i tasti imposto il valore. Con confermo e torno al menu principale</p>

Paragrafo 7 – Impostazione Ritardo Power On

Programmazione	Funzionamento
	<p>Permette di impostare un ritardo del funzionamento della pompa all' accensione della stessa. Questo ritardo ha effetto solo se la pompa viene spenta e riaccesa togliendo l'alimentazione.</p> <p>L'impostazione può essere disabilitata, Off (fabbrica) oppure si può impostare un ritardo da 1 a 60 minuti.</p> <p>Con il ritardo attivo, durante il tempo impostato il led allarme e di impulso lampeggiano contemporaneamente (1 sec On – 1 sec Off) e il display mostra il countdown in secondi. Se la pompa è in Stop vengono visualizzati solo i led lampeggianti. Durante il tempo di ritardo può essere disattivata la funzione accedendo al menu, impostando il tempo ad Off.</p> <p>Premendo  si accede alla modifica, quindi con i tasti   imposto il valore. Con  confermo e torno al menu principale</p>

Paragrafo 8 – Impostazione Ritardo Calibrazione

Programmazione	Funzionamento
	<p>Permette di impostare un ritardo del funzionamento della pompa dopo la calibrazione della sonda (Redox o pH).</p> <p>L'impostazione può essere disabilitata, Off (fabbrica) oppure si può impostare un ritardo da 1 a 60 minuti.</p> <p>Con il ritardo attivo, durante il tempo impostato il led allarme e di impulso lampeggiano contemporaneamente (1 sec On – 1 sec Off) e il display mostra il countdown in secondi. Se la pompa è in Stop vengono visualizzati solo i led lampeggianti. Durante il tempo di ritardo può essere disattivata la funzione accedendo al menu, impostando il tempo ad Off.</p> <p>Premendo  si accede alla modifica, quindi con i tasti   imposto il valore. Con  confermo e torno al menu principale</p>

Paragrafo 9 – Calibrazione portata

Programmazione	Funzionamento
	<p>Nel menu principale appare il valore di cc a colpo in memoria. È possibile calibrare in due modalità:</p> <p>MANUALE – inserisco manualmente il valore di cc a colpo con i tasti e confermo con </p> <p>AUTOMATICA – la pompa esegue 100 colpi, che vengono avviati con il tasto , alla fine dei quali con i tasti inserisco la quantità aspirata dalla pompa e confermo con .</p> <p>Il dato inserito verrà utilizzato nei calcoli delle portate.</p>

Paragrafo 10 – Statistiche

Programmazione	Funzionamento
	<p>Nel menu principale visualizza le ore di funzionamento della pompa, premendo il tasto accedo alle altre statistiche:</p> <ul style="list-style-type: none"> - Strokes = numero di colpi eseguito dalla pompa - Q.ty(L) = quantità dosata dalla pompa espressa in litri; questo dato viene calcolato in base al valore cc/stroke in memoria - Power = numero di avviamenti della pompa - Reset = con i tasti posso azzerare i contatori (YES) oppure no (NO), con confermo. <p>La pressione di permette di tornare al menu principale.</p>

Paragrafo 11 – Password

Programmazione	Funzionamento
	<p>Inserendo la password, potrò entrare in programmazione e vedere tutti i valori impostati, ma ogni volta che cercherò di modificarli verrà richiesta la password.</p> <p>La linea lampeggiante indica il numero modificabile, con il tasto seleziono il numero (da 1 a 9), con il tasto seleziono il numero da modificare, quindi con confermo. Impostando “0000” (fabbrica), la password viene esclusa.</p>

Paragrafo 12 – Allarme di flusso

Programmazione	Funzionamento
<p>The flowchart shows the steps to program the flow alarm. It starts with the 'PROG' button leading to the 'PROG Configurazione' menu. A dashed box indicates a transition to the 'Allarme Flusso Off' screen. Pressing 'enter' leads to the 'Allarme flusso Off' screen. Pressing 'enter' again leads to the 'Allarme flusso On' screen. Pressing 'enter' leads to the 'Allarme flusso -On Segnali 6' screen. Pressing 'ESC' leads to the 'Allarme Flusso Off' screen. A dashed box at the bottom indicates a return to the main menu.</p>	<p>Permette di attivare (disattivare) il sensore di flusso.</p> <p>Una volta attivato (On) premendoli tasto si accede alla richiesta di quanti segnali aspetta la pompa prima di andare in allarme. Premendo lampeggia il numero, quindi con i tasti imposto il valore. Con confermo. Premendo torno al menu principale</p>

Paragrafo 13 – Allarme di livello

Programmazione	Funzionamento
<p>The flowchart shows the steps to program the level alarm. It starts with the 'PROG' button leading to the 'PROG Configurazione' menu. A dashed box indicates a transition to the 'Allarme Livello Stop' screen. Pressing 'enter' leads to the 'Allarme livello Stop' screen. Pressing 'enter' leads to the 'Allarme livello Allarme' screen. Pressing 'enter' and 'ESC' leads to the 'Allarme Livello Allarme' screen. A dashed box at the bottom indicates a return to the main menu.</p>	<p>Permette di impostare la pompa quando si attiva l'allarme del sensore di livello, cioè blocco il dosaggio (Stop), oppure se semplicemente attivare la segnalazione d'allarme senza blocco del dosaggio.</p> <p>Premendo si accede alla modifica, quindi con i tasti imposto il tipo di allarme. Con confermo.</p> <p>Premendo torno al menu principale</p>

Paragrafo 14 – Unità visualizzazione portata

Programmazione	Funzionamento
<p>The flowchart shows the steps to program the flow unit. It starts with the 'PROG' button leading to the 'PROG Configurazione' menu. A dashed box indicates a transition to the 'Unita Standard' screen. Pressing 'enter' leads to the 'Unita Standard' screen with a cursor. Pressing 'enter' and the right arrow leads to the 'Unita L/h' screen. A dashed box at the bottom indicates a return to the main menu.</p>	<p>Permette di impostare l'unità di misura del dosaggio a display in visualizzazione.</p> <p>Premendo si accede alla modifica, quindi con i tasti imposto il tipo di unità di misura, L/h (Litri/ora), Gph (Galloni/ora), ml/m (millilitri/minuto) o standard (% o frequenza, a seconda di come impostato). Con confermo e torno al menu principale</p>

Paragrafo 15 – Impostazione Pausa

Programmazione	Funzionamento
<p>The flowchart shows the steps to program the pause setting. It starts with the 'PROG' button leading to the 'PROG Configurazione' menu. Pressing the right arrow leads to the 'Paus N.Aperto' screen. Pressing 'enter' leads to the 'Paus N.Aperto' screen with a cursor. Pressing 'enter' and the right arrow leads to the 'Paus N.Aperto' screen. A dashed box at the bottom indicates a return to the main menu.</p>	<p>Ingresso remoto per mettere in pausa la pompa. In fabbrica il sistema è impostato come Normalmente Aperto.</p> <p>Premendo si accede alla modifica, quindi con i tasti imposto il valore (N. APERTO oppure N. CHIUSO)</p> <p>Con confermo e torno al menu principale.</p>

Menu Calibrazione pH

Premendo il tasto CAL x 3 secondi si entra nel menu calibrazione, se in programmazione la calibrazione è stata esclusa, sul display appare:

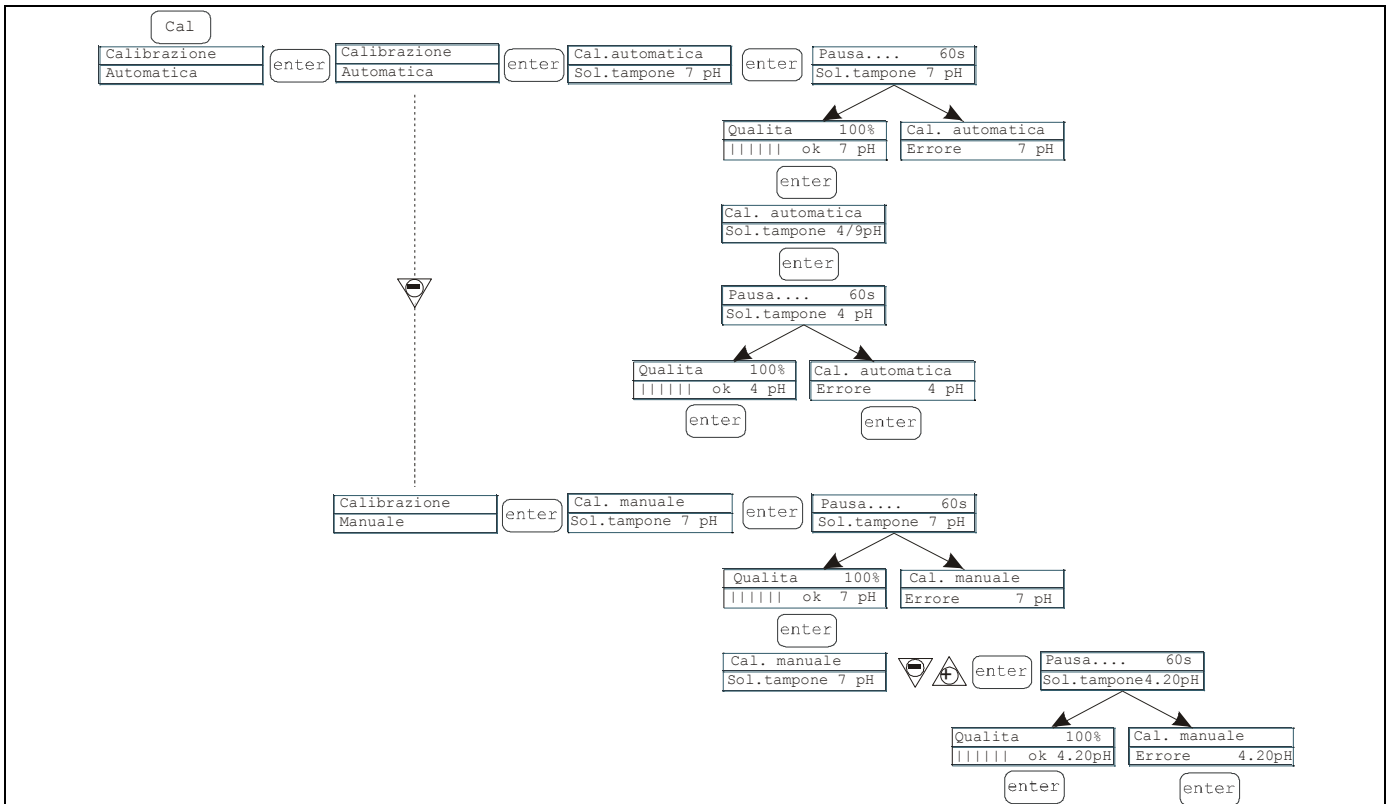

Calibrazione
Off

Se la calibrazione è attiva:









È possibile scegliere la modalità automatica o manuale, in entrambi i casi la calibrazione a pH 7 avviene in automatico.

- Calibrazione automatica:

Sul display appare il valore della soluzione tampone, inserire la sonda nella bocchetta, premendo  a display appare il conteggio alla rovescia dei 60 secondi necessari a completare la calibrazione. Se la qualità dell'allineamento è inferiore al 50% appare errore a display e premendo  si esce dalla calibrazione (dopo 4 secondi la pompa esce automaticamente), se la qualità è superiore al 50%, il valore viene visualizzato a display e premendo  viene richiesta la soluzione tampone a pH 4 o 9; a questo punto la procedura è uguale alla precedente.

- Calibrazione manuale:

quando sul display appare il valore della soluzione tampone inserire la sonda nella bocchetta, premendo  a display appare il conteggio alla rovescia dei 60 secondi necessari a completare la calibrazione. Se la qualità dell'allineamento è inferiore al 50% appare errore a display e premendo  si esce dalla calibrazione (dopo 4 secondi la pompa esce automaticamente), se la qualità è superiore al 50%, il valore viene visualizzato a display e premendo  sul display lampeggia il valore di pH 7.00, con i tasti   inserisco il valore della soluzione in mio possesso, quindi premendo  confermo ed avvio la procedura di calibrazione come in precedenza.

Menu Calibrazione Potenziale Redox (O.R.P.)

Premendo il tasto CAL x 3 secondi si entra nel menu calibrazione, se in programmazione la calibrazione è stata esclusa, sul display appare:

Calibrazione
Off

Se la calibrazione è attiva:

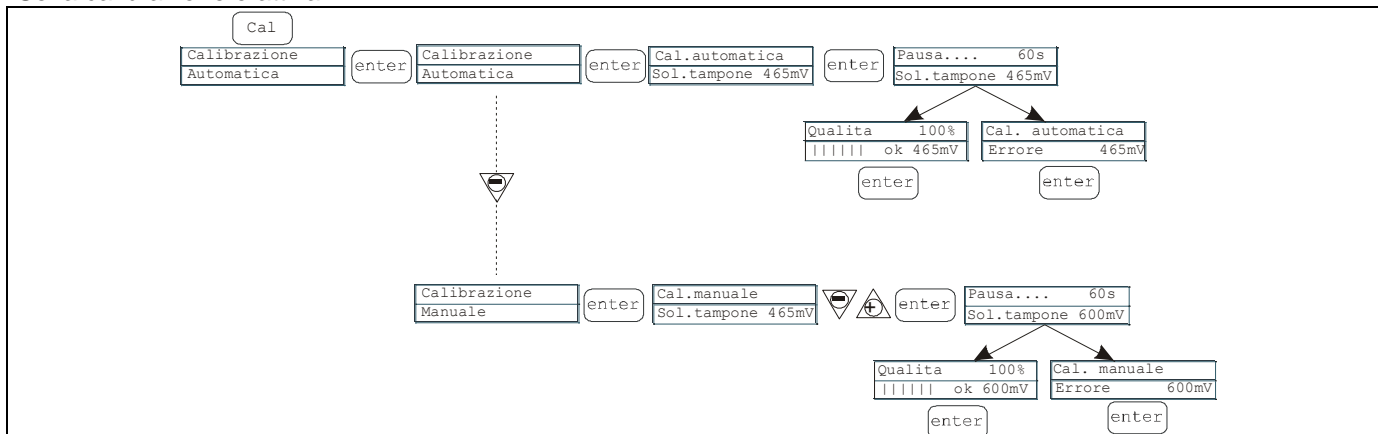

È possibile scegliere la modalità automatica o manuale.

- Calibrazione automatica:



sul display appare il valore della soluzione tampone inserire la sonda nella boccetta, premendo  a display appare il conteggio alla rovescia dei 60 secondi necessari a completare la calibrazione. Se la qualità

dell'allineamento è inferiore al 50% appare errore a display e premendo  si esce dalla calibrazione (dopo 4 secondi la pompa esce automaticamente), se la qualità è superiore al 50%, il valore viene visualizzato a display e

premendo  viene completata la procedura.





- Calibrazione manuale:

sul display appare il valore della soluzione tampone inserire la sonda nella boccetta, premendo  sul display

lampeggia il valore di 465mV, inserisco la sonda nella mia soluzione, quindi con i tasti   visualizzo il

valore della soluzione in mio possesso, quindi premendo  confermo ed avvio la procedura di calibrazione come in precedenza.

Allarmi

Visualizzazione	Causa	Interruzione				
Led Alarm fisso Scritta Lev lampeggiante Es: <table border="1" style="display: inline-table; vertical-align: middle;"> <tr> <td>Man</td> <td></td> </tr> <tr> <td>Lev</td> <td>P100%</td> </tr> </table>	Man		Lev	P100%	Allarme fine di livello, senza interruzione del funzionamento della pompa.	Ripristino del livello del liquido.
Man						
Lev	P100%					
Led Alarm fisso Scritta Lev e Stop lampeggianti Es: <table border="1" style="display: inline-table; vertical-align: middle;"> <tr> <td>Man</td> <td></td> </tr> <tr> <td>Lev Stop</td> <td>P100%</td> </tr> </table>	Man		Lev Stop	P100%	Allarme fine di livello, con interruzione del funzionamento della pompa.	Ripristino del livello del liquido.
Man						
Lev Stop	P100%					
Scritta Mem lampeggiante Es: <table border="1" style="display: inline-table; vertical-align: middle;"> <tr> <td>1:n</td> <td>6</td> </tr> <tr> <td>Mem</td> <td></td> </tr> </table>	1:n	6	Mem		La pompa riceve uno o più impulsi durante il dosaggio con funzione memory in Off.	Pressione del tasto 
1:n	6					
Mem						
Scritta Mem lampeggiante Es: <table border="1" style="display: inline-table; vertical-align: middle;"> <tr> <td>1:n</td> <td>M 6</td> </tr> <tr> <td>Mem</td> <td></td> </tr> </table>	1:n	M 6	Mem		La pompa riceve uno o più impulsi durante il dosaggio con funzione memory in On.	Quando la pompa finisce di ricevere gli impulsi esterni restituisce i colpi memorizzati
1:n	M 6					
Mem						
Led Alarm fisso Scritta Flw lampeggiante Es: <table border="1" style="display: inline-table; vertical-align: middle;"> <tr> <td>Man</td> <td>F</td> </tr> <tr> <td>Flw</td> <td>P100%</td> </tr> </table>	Man	F	Flw	P100%	Allarme di flusso attivo, la pompa non ha ricevuto il numero di segnali programmati dal sensore di flusso.	Pressione del tasto 
Man	F					
Flw	P100%					
Es: <table border="1" style="display: inline-table; vertical-align: middle;"> <tr> <td>Parameter Error</td> <td></td> </tr> <tr> <td>PROG to default</td> <td></td> </tr> </table>	Parameter Error		PROG to default		Errore di comunicazione con la eeprom.	Pressione del tasto  per ripristinare i parametri di fabbrica.
Parameter Error						
PROG to default						
Scritta "OFA" lampeggiante Scritta "Stop" lampeggiante Es: <table border="1" style="display: inline-table; vertical-align: middle;"> <tr> <td>High</td> <td>475 mV OFA</td> </tr> <tr> <td>Stop</td> <td>P 75%</td> </tr> </table>	High	475 mV OFA	Stop	P 75%	Allarme O.F.A.	Pressione del tasto  per bloccare il lampeggio della scritta Stop, ulteriore pressione del tasto per riavviare la pompa.
High	475 mV OFA					
Stop	P 75%					
Scritta "Alm" lampeggiante Es: <table border="1" style="display: inline-table; vertical-align: middle;"> <tr> <td>High</td> <td>475 mV Alm</td> </tr> <tr> <td>P</td> <td>75%</td> </tr> </table>	High	475 mV Alm	P	75%	Il valore letto dalla sonda è fuori dall'intervallo della banda d'allarme impostata	Controllare la corretta impostazione del parametro "Banda Allarme" in programmazione.
High	475 mV Alm					
P	75%					
Scritta "Cal" lampeggiante Es: <table border="1" style="display: inline-table; vertical-align: middle;"> <tr> <td>High</td> <td>475 mV Cal</td> </tr> <tr> <td>P</td> <td>75%</td> </tr> </table>	High	475 mV Cal	P	75%	Allarme sonda non calibrata	Effettuare la procedura di calibrazione della sonda.
High	475 mV Cal					
P	75%					

Painel de Controle – OPTIMA PLUS



	Acesso ao menú de programação.
	Durante a fase de funcionamento da bomba: Se acionado mostra ciclicamente no display os valores programados; Se acionado simultaneamente as teclas aumenta ou reduz um valor dependendo da modalidade de funcionamento preescolhida. Em programação faz a função “enter”, isto é, confirma a entrada nos vários níveis de menú e as modificações no interior dos mesmos.
	Liga e deliga a bomba. Nas condições de alarme de nível (só função alarme), de fluxo e memory ativas, desativa a sinalização no display.
	Para “sair” dos vários níveis de menú. Antes de sair definitivamente da programação se acessa ao pedido de salvar as modificações.
	Acesso ao menú de calibração da bomba. Se na modalidade Off, o menú de calibração não é ativado.
	Percorre os menús para o alto, ou ainda, aumenta os valores numéricos a modificar. Na modalidade Batch pode acionar a dosagem.
	Percorre os menús para baixo, ou ainda, reduz os valores numéricos a modificar.
	Led verde lampejante durante a dosagem.
	Led vermelho que ascende nas varias situações de alarme.

Conexões Elétricas

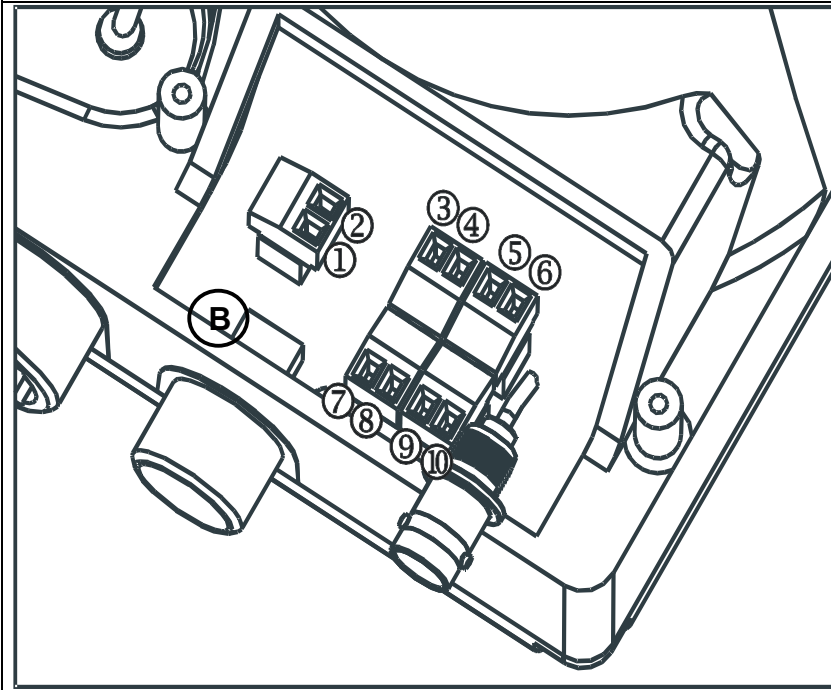



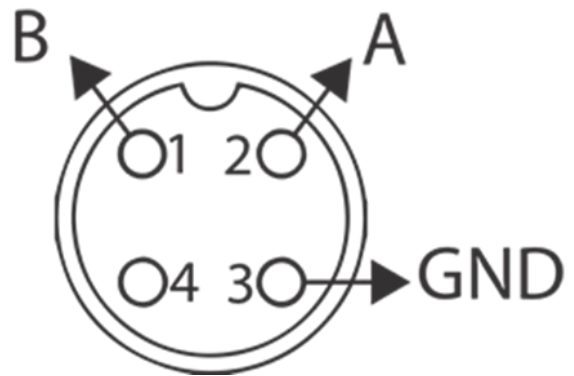

1	Relê de alarme	
2	Relê de alarme	
3	Polo +	Saída 4-20 mA
4	Polo -	
5	Entrada do controle remoto (start-stop)	
6	Entrada do controle remoto (start-stop)	
7	Entrada da sonda de temperatura	
8	Entrada da sonda de temperatura	
9	Entrada do sensor de fluxo	
10	Entrada do sensor de fluxo	
B	Entrada da sonda de controle de nível	

Conexao ModBus	
Pin N°	Descrição
1	T+R+
2	T-R-
3	GND
4	Nao utilizado



Menú de Programação Optima Plus

Acionando a tecla  por mais de três segundos se acessa a programação. Com as teclas   será

possível correr os itens do menú, com a tecla  se acessa as modificações. De fábrica a bomba vem programada na modalidade constante. A bomba volta automaticamente à modalidade de funcionamento depois de 1 minuto de inatividade. Neste caso dados eventualmente inseridos não são salvos.

Com a tecla  se sai dos níveis da programação. Na saída da programação o display mostra:

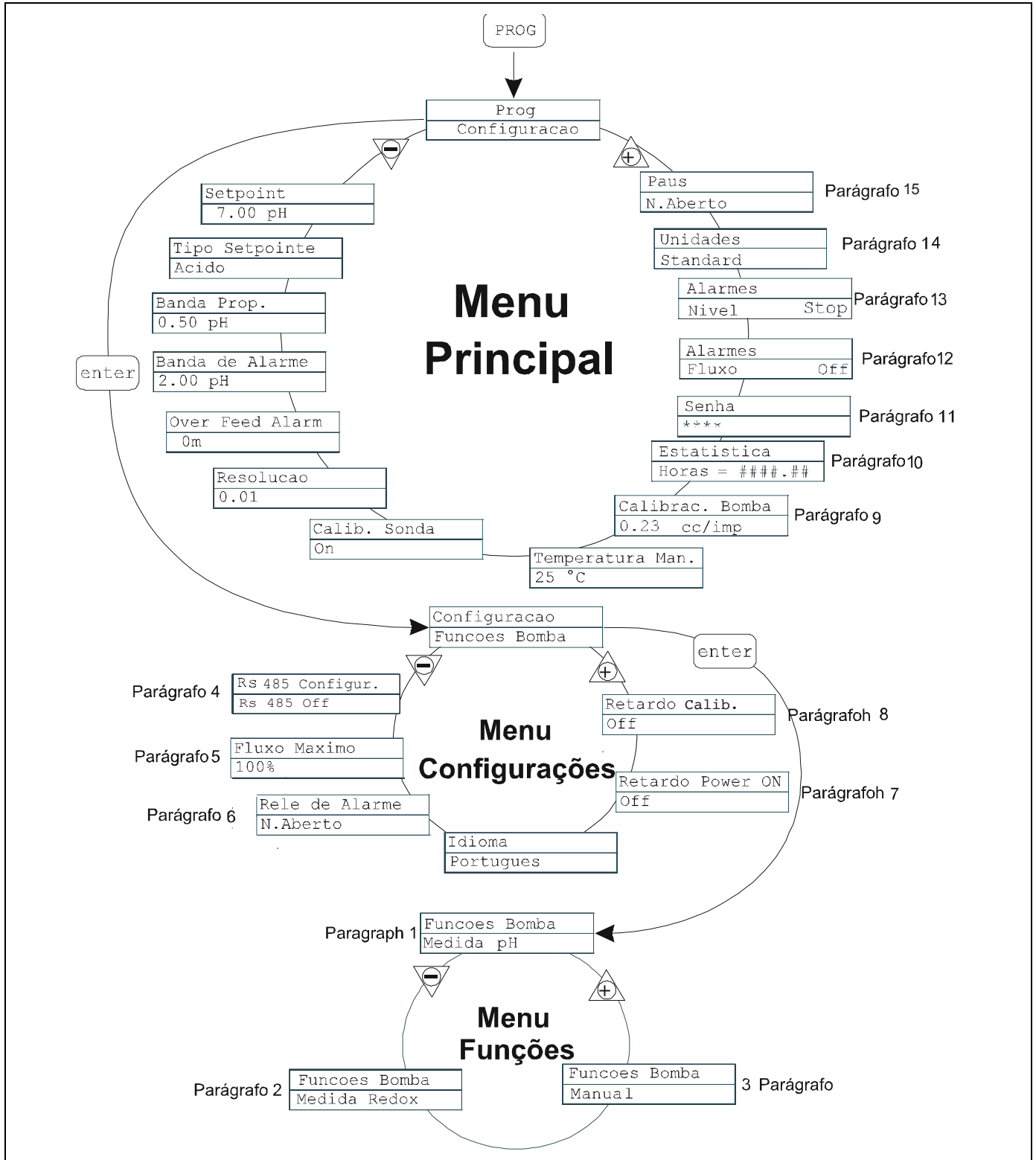
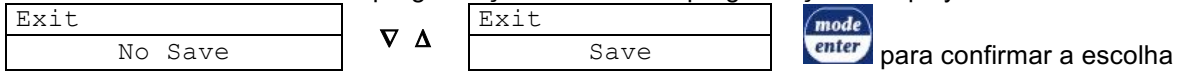

Seleção do Idioma

Programação	Funcionamento
	<p>Permite selecionar o idioma, de fábrica a bomba vem programada em inglês.</p> <p>Acionando se acessa à modificação, a seguir, com as teclas seleciono o valor. Com confirmo e volto ao menu principal</p>

Parágrafo 1 - Dosagem Manual

Programação	Funcionamento
	<p>A bomba trabalha em modalidade constante. A vazão é regulada manualmente acionando simultaneamente as teclas e para aumentar a vazão, ou ainda, as teclas e para diminuí-la.</p>





Visualização durante o funcionamento	Visualização na seleção (tecla MODE)

Parágrafo 2 - Dosagem Proporcional à medida do pH (selecionado em fábrica)

Programação	Funcionamento
<p> PROG PROG Configuracao enter Configuracao Funcoes Bomba enter Funcoes Bomba Medida pH enter Setpoint 7.00 pH enter Tipo Setpoint Acido enter Banda Prop. 0.50 pH enter Banda de Alarme 2.00 pH enter Over Feed Alarm 0m enter Resolucao 0.01 enter Calib. Sonda On enter Temperatura Man. 25 °C enter Temperatura Man. 25 °C enter Temperatura Man. 77 °F enter </p>	<p> A bomba mede e controla o valor do pH de uma solução, programando em seguida: set-point, tipo de set-point, banda proporcional e banda de alarme. </p> <p> Tipo set-point: ácido </p> <p> Tipo de set-point: alcalino </p> <p> Pode-se, além disso, programar: </p> <ul style="list-style-type: none"> - o tempo O.F.A. (Over Feed Alarm) em minutos, isto é, um tempo além do qual se a medida do pH não chega ao set-point, se ativa um sinal de alarme. - A resolução da medida (1 ou 2 cifras decimais) - Desativação/ativação do procedimento de calibração - Valor manual da temperatura em °C (fábrica) ou °F <p> A frequência máxima é modificável durante a fase de funcionamento acionando simultaneamente as teclas para aumentar a vazão, ou ainda as teclas para diminuí-la. </p>

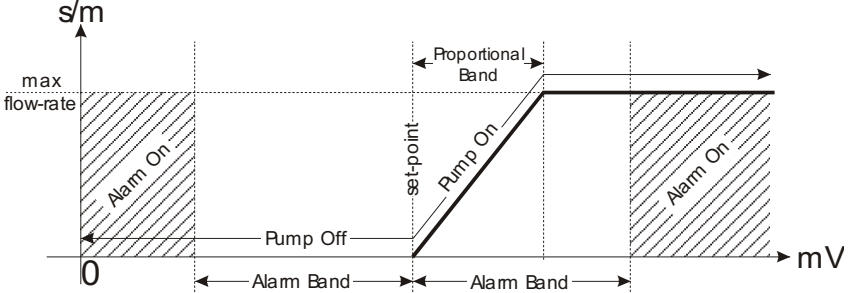
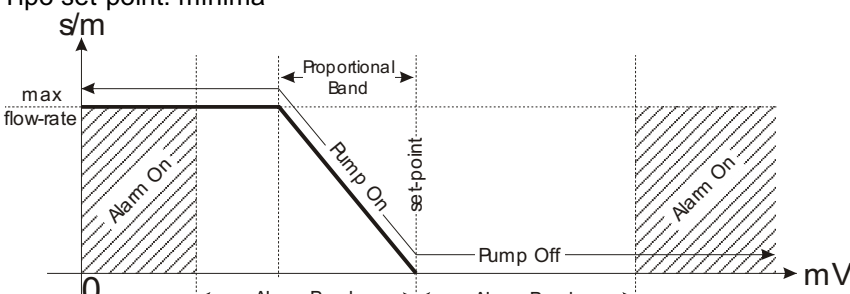
Visualização durante o funcionamento	Visualização na seleção (tecla MODE)
<p> Tipo setpoint; Acido/Alcalino </p> <p> Estado do sensor de Fluxo </p> <p> Valor medida do pH. </p> <p> Alca F 7.00pH Niv Stop P100% </p> <p> Alarmes e estados </p> <ul style="list-style-type: none"> • Cal = calibração não feita • Niv = Alarme de nível • Flx = Alarme de fluxo • Alm = Medida fora da Banda alarme • OFA = Alarme O.F.A. <p> Estado da bomba </p> <ul style="list-style-type: none"> • Vazio = bomba em start • Stop = bomba parada <p> Valor da dosagem em curso (depende da unidade de medida selecionada) </p> <ul style="list-style-type: none"> • Porcentual, Frequência, l/h, Gph, ml/m 	<p> Mostra em sequência </p> <ul style="list-style-type: none"> • SP = valor Setpoint • BP = valor Banda Proporcional • BA = valor Banda Alarme • OFA = Valor O.F.A. • Temp = valor Temperatura <p> SP 7.00pH 4.50pH P100% </p> <p> Valor da medida. </p> <p> Valor da dosagem máxima selecionada (depende da unidade de medida selecionada) </p> <ul style="list-style-type: none"> • Porcentual, Frequência, l/h, Gph, ml/m

Parágrafo 3 – Dosagem Proporcional à medida do potencial Redox (O.R.P.)

Programação	Funcionamento
<pre> PROG ----- PROG Configuracao ----- enter Configuracao Funcoes Bomba ----- enter [] [] ----- Funcoes Bomba Medida Redox ----- enter Setpoint enter [] [] enter 560 mV ----- Tipo Setpoint enter [] [] enter Alto ----- Banda Prop. enter [] [] enter 50 mV ----- Banda de Alarme enter [] [] enter 200 mV ----- Over Feed Alarm enter [] [] enter 0m ----- Calib. Sonda enter [] [] enter On ----- [] </pre>	<p>A bomba mede e controla o valor do pH de uma solução, programando na sequência: set-point, tipo de set-point, banda proporcional e banda de alarme.</p> <p>Tipo set-point: máxima</p>  <p>Tipo set-point: mínima</p>  <p>Se pode também programar:</p> <ul style="list-style-type: none"> - o tempo O.F.A. (Over Feed Alarm) em minutos, isto é, um tempo além do qual se a medida do pH não chega ao set-point, se ativa um sinal de alarme. - A resolução da medida (1 ou 2 cifras decimais) - Desativação/ativação do procedimento de calibração <p>A frequência máxima é modificável durante o funcionamento acionando simultaneamente as teclas   para aumentar a vazão ou ainda as teclas   para diminuí-la.</p>

Visualização durante o funcionamento	Visualização na seleção (tecla MODE)
<pre> Estado do sensor de Fluxo ----- Tipo setpoint; Alto /Baixo ----- Alarmes e estados • Cal = calibração não feita • Niv = Alarme de nível • Flx = Alarme de fluxo • Alm = Medida fora da Banda alarme • OFA = Alarme O.F.A. ----- Estado da bomba • Vazia = bomba em start • Stop = bomba parada ----- Valor da medida do potencial Redox ----- Valor da dosagem em curso (depende da unidade de medida selecionada) • Porcentual, Frequência, l/h, Gph, ml/m ----- Alto F 560mV Niv Stop P100% </pre>	<pre> Visualiza na sequência • SP = valor do Setpoint • BP = valor Banda Proporcional • BA = valor Banda Alarme • OFA = Valore O.F.A. ----- SP 560mV 450mV P100% ----- Valor da dosagem máxima selecionada (depende da unidade de medida selecionada) • Porcentual, Frequência, l/h, Gph, ml/m </pre>

Parágrafo 4 – Rs 485 Config.

Programming	Operation
	<p>Isso torna possível para ativar (desativar) a comunicação Modbus RS485 (ativado por padrão) .</p> <p>Se o Active no menu mostrará os seguintes itens :</p> <ul style="list-style-type: none"> -BaudRate: é possível definir o BaudRate como 2400, 4800, 9600, 19200 ou 38400 (9600 por padrão). -Parity : É possível definir a paridade como Par, Ímpar ou Não (desativado) . -Address: é possível definir a comunicação endereço do dispositivo de 1 a 247 (1 por padrão). -Timeout: É possível definir o tempo limite Watchdog , se é desativado caso contrário, é possível definir um tempo de 1 a 65535 segundos (desativado por padrão) . -Hardware Reset: é possível definir a comunicação Watchdog como Hardware Reset, Com. Reset, Parada Dosagem e WDG Alarme (WDG Alarme por padrão). <p>As alterações podem ser feitas pressionando a key, em seguida, usando o keys o definir o novo valor. Selecionar para confirmar e voltar ao menu principal.</p>

Parágrafo 5 - Seleção de Máxima Vazão

Programação	Funcionamento
	<p>Permite selecionar a máxima vazão que a bomba pode alcançar e a modalidade programada (% ou frequência) permanecendo a visualização da vazão na unidade de medida standard. Acionando se acessa a modificação, e a seguir, com as teclas seleciono o valor. Com confirmo e volto ao menu principal</p>

Parágrafo 6 - Seleção do Relê de Alarme

Programação	Funcionamento
	<p>Serve para selecionar o relê de alarme na ausência da situação de alarme, se aberto (fábrica) ou ainda, fechado.</p> <p>Acionando se acessa a modificação, e a seguir, com as teclas seleciono o valor. Com confirmo e volto ao menu principal</p>

Parágrafo 7 - Definição Atraso Power On

Programação	Funcionamento
<p>The flowchart shows the navigation path: PROG → CONFIGURACAO → CONFIGURACAO Funcoes Bomba → Fluxo Maximo 2100% → Relé de Alarme N. Aberto → Idioma Portugues → Retardo Power ON Off. From 'Retardo Power ON Off', pressing 'enter' leads to a screen with '+' and '-' buttons. Pressing '+' or '-' changes the value, and pressing 'mode enter' returns to the main menu.</p>	<p>Permite definir um atraso do funcionamento da bomba quando a mesma é ligada. Este atraso tem efeito só se a bomba fôr desligada e ligada novamente retirando a alimentação. A configuração pode ser desactivada, Off (de fábrica) ou pode-se configurar um atraso de 1 a 60 minutos.</p> <p>Com o atraso activo, durante o tempo configurado o led de alarme e o de impulso lampejam simultâneamente (1 seg. On – 1 seg. Off) e o display mostra a contagem decrescente em segundos. Se a bomba estiver em Stop visualizam-se só os leds lampejantes. Durante o tempo de atraso a função pode ser desactivada acedendo ao menú, definindo o tempo para Off.</p> <p>Premindo acede-se à modificação, portanto com as teclas define-se o valor. Com confirma-se e regressa-se ao menú principal.</p>

Parágrafo 8 - Definição Atraso Calibração

Programação	Funcionamento
<p>The flowchart shows the navigation path: PROG → CONFIGURACAO → CONFIGURACAO Funcoes Bomba → Fluxo Maximo 2100% → Relé de Alarme N. Aberto → Idioma Portugues → Retardo Power ON Off → Retardo Calib. Off. From 'Retardo Calib. Off', pressing 'enter' leads to a screen with '+' and '-' buttons. Pressing '+' or '-' changes the value, and pressing 'mode enter' returns to the main menu.</p>	<p>Usado para definir um atraso funcionamento da bomba após a calibração da sonda (Redox ou pH). A configuração pode ser desactivada, Off (de fábrica) ou pode-se configurar um atraso de 1 a 60 minutos.</p> <p>Com o atraso activo, durante o tempo configurado o led de alarme e o de impulso lampejam simultâneamente (1 seg. On – 1 seg. Off) e o display mostra a contagem decrescente em segundos. Se a bomba estiver em Stop visualizam-se só os leds lampejantes. Durante o tempo de atraso a função pode ser desactivada acedendo ao menú, definindo o tempo para Off.</p> <p>Premindo acede-se à modificação, portanto com as teclas define-se o valor. Com confirma-se e regressa-se ao menú principal.</p>

Parágrafo 9 - Calibração da Vazão

Programação	Funcionamento
	<p>No menú principal aparece o valor de cc por golpe memorizado. É possível calibrar em duas modalidades:</p> <p>MANUAL - Insiro manualmente o valor de cc por golpe com as teclas e confirmo com </p> <p>AUTOMÁTICA - A bomba executa 100 golpes, que são acionados pela tecla , no fim dos quais com as teclas insiro a quantidade aspirada pela bomba e confirmo com . O dado inserido será utilizado nos cálculos das vazões.</p>

Parágrafo 10 - Estatísticas

Programação	Funcionamento
	<p>No menú principal visualizam-se as horas de funcionamento da bomba, acionando a tecla acesso as outras estatísticas:</p> <ul style="list-style-type: none"> - Golpes = número de golpes executado pela bomba. - Qde.(L) = quantidade dosada pela bomba expressa em litros; este dado é calculado com base no valor cc/golpe na memória - Ascendimentos = número de ligações da bomba - Reset = com as teclas posso zerar os contadores (YES) ou ainda não (NO), com confirmo. <p>O acionamento de permite voltar ao menú principal.</p>

Parágrafo 11 - Senha

Programação	Funcionamento
	<p>Inserindo a senha, poderei entrar na programação e ver todos os valores selecionados, mas a cada vez que procurar modificá-los será solicitada a senha. A linha lampejante indica o número modificável, com a tecla seleciono o número (de 1 a 9), com a tecla seleciono o número a modificar, e a seguir com confirmo. Selecionando "0000" (fábrica), a senha é excluída.</p>

Parágrafo 12 - Alarme de Fluxo

Programação	Funcionamento
	<p>Permite ativar (desativar) o sensor de fluxo.</p> <p>Uma vez ativado (On) ativando a tecla se acessa a requisição de quantos sinais a bomba espera antes de entrar em em alarme. Acionando lampeja o número, a seguir, com as teclas seleciono o valor. Com confirmo. Acionando volto ao menú principal</p>

Parágrafo 13 - Alarme de Nível

Programação	Funcionamento
	<p>Permite selecionar a bomba quando se ativa o alarme do sensor de nível, isto é, bloqueio a dosagem (Stop), ou ainda simplesmente ativar a sinalização de alarme sem bloqueio da dosagem.</p> <p>Acionando se acessa a modificação, a seguir, com as teclas selecionoo tipo de alarme. Com confirmo. Acionando volto ao menú principal</p>

Parágrafo 14 - Unidade de Visualização de Vazão

Programação	Funcionamento
	<p>Permiite selecionar a unidade de medida da dosagem no display em visualização.</p> <p>Acionando se acessa a modificação, a seguir, com as teclas selecionoo o tipo de unidade de medida L/h (Litros/hora), Gph (Galões/hora), ml/m (mililitros/minuto) ou standard (% ou frequência, segundo foi selecionado). Com confirmo e volto ao menú principal</p>

Parágrafo 15 – Ajuste Pausa

Programação	Funcionamento
	<p>Entrada remota para colocar a bomba em pausa. Em fábrica o sistema é ajustado como Normalmente Aberto.</p> <p>Ao premir poderá ter acesso à alteração. Com as teclas poderá ajustar o valor (N. ABERTO ou N. FECHADO)</p> <p>Com poderá confirmar e voltar ao menu principal.</p>

Menú de Calibragem de pH

Acionando a tecla CAL x 3 segundos se entra no menú de calibragem, se na programação a calibragem foi excluída, no display aparece:

Calibragem
Off

Se a calibragem estiver ativa:

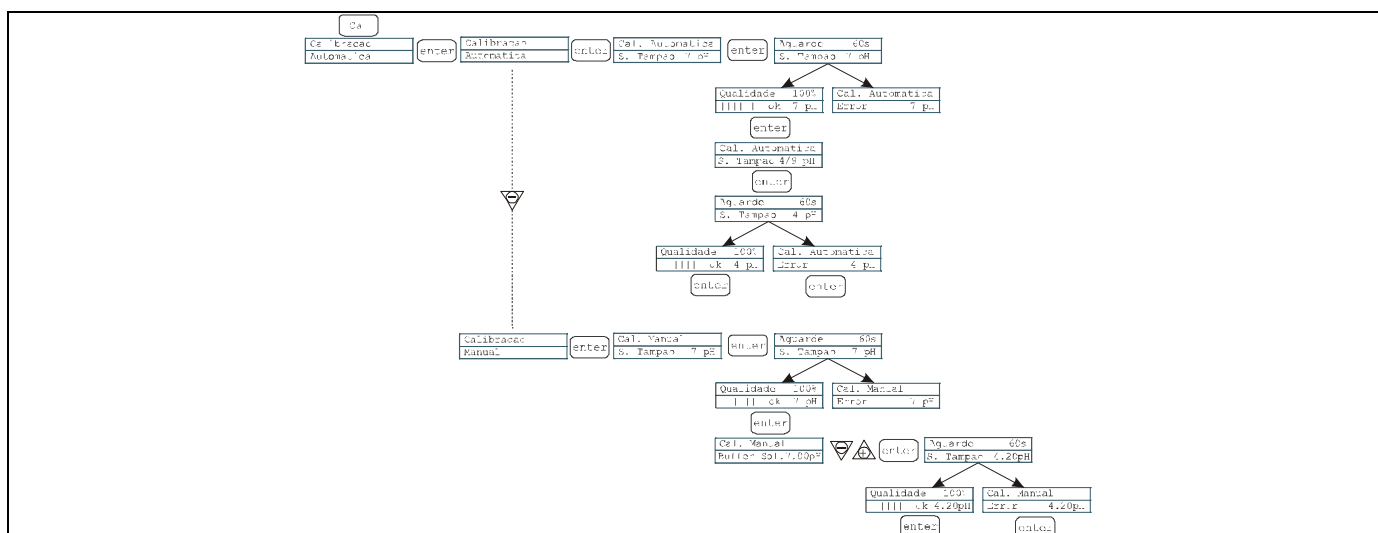

É possível escolher a modalidade automática ou manual, em ambos os casos a calibragem no pH 7 acontece automaticamente.

- Calibragem Automática:

No display aparece o valor da solução tampão, inserir a sonda no frasco, acionando no display aparece a contagem ao contrário dos 60 segundos necessários para completar a calibragem. Se a qualidade do alinhamento

for inferior a 50% aparece erro no display e acionando se sai da calibragem (depois de 4 segundos a bomba sai automaticamente), se a qualidade for superior a 50%, o valor é visualizado no display e

acionando é solicitada a solução tampão no pH 4 ou 9; neste ponto o procedimento é igual ao precedente.

- Calibragem manual:

Quando no display aparece o valor da solução tampão inserir a sonda no frasco, acionando no display aparece a contagem ao contrário dos 60 segundos necessários a completar a calibragem. Se no display a

qualidade do alinhamento for inferior a 50% aparece erro no display e acionando se sai da calibragem (depois de 4 segundos a bomba sai automaticamente), se a qualidade for superior a 50%, o valor é visualizado no

display e acionando no display lampeja o valor do pH 7.00, com as teclas insiro o valor da

solução em meu poder, a seguir, acionando confirmo e inicio o procedimento de calibragem como precedentemente.

Menú de Calibração Potencial Redox (O.R.P.)

Acionando a tecla CAL x 3 segundos se entra no menú de calibração, se na programação a calibração foi excluída, no display aparece:

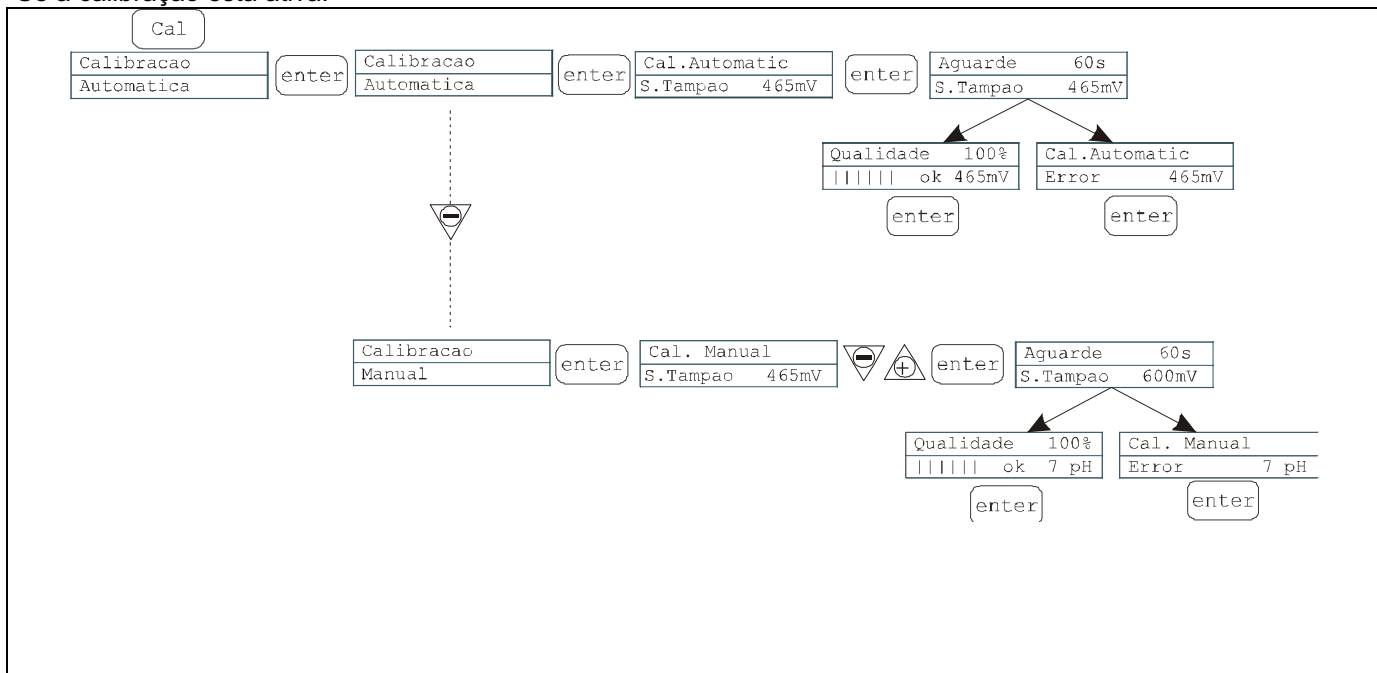

Calibração
Off

Se a calibração está ativa:







É possível escolher a modalidade automática ou manual.





- Calibração Automática:

No display aparece o valor da solução tampão inserir a sonda no frasco, acionando  no display aparece a contagem ao contrario dos 60 segundos necessários para completar a calibração. Se a qualidade do alinhamento for inferior a 50% aparece erro no display e acionando  se sai da calibração (depois de 4 segundos a bomba sai automaticamente), se a qualidade for superior a 50%, o valor é visualizado no display e acionando  é completado o procedimento.

- Calibração manual:

No display aparece o valor da solução tampão inserir a sonda no frasco, acionando  no display lampeja o valor de 465mV, insiro a sonda na minha solução, a seguir com as teclas   visualizo o valor da solução em meu poder, a seguir, acionando  confirmo e inicio o procedimento de calibração como precedentemente.

Alarmes

Visualização	Causa	Interrupção						
Led de Alarme fixo Escrito Lev lampejante Ex: <table border="1" style="display: inline-table; vertical-align: middle;"> <tr> <td>Man</td> <td></td> <td></td> </tr> <tr> <td>Lev</td> <td>P100%</td> <td></td> </tr> </table>	Man			Lev	P100%		Alarme de final de nível, sem interrupção do funcionamento da bomba.	Recomposição do nível do líquido.
Man								
Lev	P100%							
Led de Alarme fixo Escrita Lev e Stop lampejantes Ex: <table border="1" style="display: inline-table; vertical-align: middle;"> <tr> <td>Man</td> <td></td> <td></td> </tr> <tr> <td>Lev Stop</td> <td>P100%</td> <td></td> </tr> </table>	Man			Lev Stop	P100%		Alarme de final de nível, com interrupção de funcionamento da bomba.	Recomposição do nível do líquido.
Man								
Lev Stop	P100%							
Escrito Mem lampejante Ex: <table border="1" style="display: inline-table; vertical-align: middle;"> <tr> <td>1:n</td> <td>6</td> <td></td> </tr> <tr> <td>Mem</td> <td></td> <td></td> </tr> </table>	1:n	6		Mem			A bomba recebe um ou mais impulsos durante a dosagem com função memory em Off.	Acionar a tecla 
1:n	6							
Mem								
Escrito Mem lampejante Ex: <table border="1" style="display: inline-table; vertical-align: middle;"> <tr> <td>1:n</td> <td>M</td> <td>6</td> </tr> <tr> <td>Mem</td> <td></td> <td></td> </tr> </table>	1:n	M	6	Mem			A bomba recebe um ou mais impulsos durante a dosagem com função memory em On.	Quando a bomba acaba de receber os impulsos externos devolve os golpes memorizados
1:n	M	6						
Mem								
Led de Alarme fixo Escrito Flw lampejante Ex: <table border="1" style="display: inline-table; vertical-align: middle;"> <tr> <td>Man</td> <td>E</td> <td></td> </tr> <tr> <td>Flw</td> <td>P100%</td> <td></td> </tr> </table>	Man	E		Flw	P100%		Alarme de fluxo ativo, a bomba não recebeu o número de sinais programados pelo sensor de fluxo.	Acionar a tecla 
Man	E							
Flw	P100%							
Ex: <table border="1" style="display: inline-table; vertical-align: middle;"> <tr> <td>Parameter Error</td> <td></td> </tr> <tr> <td>PROG to default</td> <td></td> </tr> </table>	Parameter Error		PROG to default		Erro de comunicação com a eeprom.	Acionar a tecla  para restaurar os os parâmetros de fábrica.		
Parameter Error								
PROG to default								
Escrito "OFA" lampejante Escrito "Stop" lampejante Ex: <table border="1" style="display: inline-table; vertical-align: middle;"> <tr> <td>High</td> <td>475 mV OFA</td> <td></td> </tr> <tr> <td>Stop</td> <td>P 75%</td> <td></td> </tr> </table>	High	475 mV OFA		Stop	P 75%		Alarme O.F.A.	Acionar a tecla  para bloquear o lampejo da escrita Stop, posterior acionamento da tecla para religar a bomba.
High	475 mV OFA							
Stop	P 75%							
Escrito "Alm" lampejante Ex: <table border="1" style="display: inline-table; vertical-align: middle;"> <tr> <td>High</td> <td>475 mV Alm</td> <td></td> </tr> <tr> <td>P</td> <td>75%</td> <td></td> </tr> </table>	High	475 mV Alm		P	75%		O valor lido pela sonda está fora do intervalo da banda de alarme selecionada	Verificar correta seleção do parâmetro "Banda de Alarme" na programação.
High	475 mV Alm							
P	75%							
Escrito "Cal" lampejante Ex: <table border="1" style="display: inline-table; vertical-align: middle;"> <tr> <td>High</td> <td>475 mV Cal</td> <td></td> </tr> <tr> <td>P</td> <td>75%</td> <td></td> </tr> </table>	High	475 mV Cal		P	75%		Alarme de sonda não calibrado	Efetuar o procedimento de calibragem da sonda.
High	475 mV Cal							
P	75%							