

ARCO ARCOMAX

Instructions for installation and use - English
Electric robotic cleaner
Translation of the original instructions in French

EN



More documents on:
www.zodiac.com

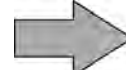

WARNINGS

- Before handling the appliance, it is vital that you read this installation and user manual, as well as the "warnings and warranty" booklet delivered with the appliance. Failure to do so may result in material damage or serious or fatal injury and will void the warranty.
- Keep and pass on these documents for later consultation during the appliance's service life.
- This manual has been edited in the language of the country where you purchased your device.
- You can also find these instructions on the Zodiac website www.zodiac.com
- The distribution or modification of this document in any way is prohibited, without prior authorisation from Zodiac®.
- Zodiac® is constantly developing its products to improve their quality. The information contained herein may therefore be modified without notice.

EN

GENERAL WARNINGS

- Failure to respect the warnings may cause serious damage to the pool equipment or cause serious injury, even death.
- This electric robot is a professional robot. Only a person qualified in the technical fields concerned (electrical, hydraulic or refrigeration), is authorised to use it and to make maintenance or repair of the appliance. The qualified technician who intervenes on the appliance must use/wear personal protective equipment to reduce any risk of injury that may occur when intervening on the appliance.
- Before any intervention on the appliance, ensure that the latter is switched off and disconnected from the power supply, in addition to any other equipment connected to the appliance, and that the heating priority (where applicable) is deactivated.
- The device is designed for specific use in swimming pools ; it must not be used for any other option than that for which it was designed.
- This appliance is not intended for use by persons (including children) persons with reduced physical, sensory or mental capabilities, or persons without experience or knowledge, unless they have been given prior supervision or instruction in the use of the appliance by a person responsible for their safety. Children should be supervised to ensure that they do not play with the appliance.
- This appliance may be used by children of at least 8 years of age and by persons with reduced physical, sensory or mental capabilities or lacking experience or knowledge, they are properly supervised or instructed in the safe use of the equipment and the risks involved are understood. Cleaning and maintenance by the user must not be carried out by unsupervised children.
- The appliance must be installed according to the manufacturer's instructions and in compliance with the local and national standard. The installer is responsible for installing the appliance and for compliance with national installation regulations. Under no circumstances may the manufacturer be held reliable in the events of failure to comply with applicable local installation standards.
- If the appliance suffers a malfunction, do not try to repair the appliance yourself, instead contact a qualified technician.
- Refer to the warranty conditions for details of the permitted water balance values for operating the appliance.
- Deactivating, eliminating or by-passing any of the safety mechanisms integrated into the appliance shall automatically void the warranty, in addition to the use of spare parts manufactured by unauthorised third-party manufacturers.
- Do not spray insecticide or any other chemical in the direction of the appliance, as this may and cause a fire.
- Do not touch the fan or insert a rod or your fingers through the grid when the appliance is in operation. The fan rotates at high speed and may cause serious injuries or even death.
- It is banned to open the control box when it is connected to the mains, this action

- may cause an electric shock. Contact a qualified technician.
- Do not place anything on the robot or on the control box (except for the radio control).
 - Do not use the robot if any of its components are defective or missing (pump, turbine, screw, nut, cable, etc.).
 - Do not shorten or extend the floating cable.

WARNINGS RELATED TO ELECTRICAL APPLIANCES

- The power supply to the appliance must be protected by a 30 mA Residual Current Device (RCD), in accordance with standards in force in the country of installation. This circuit breaker must be tested before using the robot. Press test button : the circuit breaker must stop the current ; press button again : it restarts the current. If the operation is not carried out according to these instructions, the circuit breaker is defective. If the circuit breaker shuts off the power outside the test procedure, it indicates that there is a current leakage which can cause an electric shock. In this situation, do not use the robot and contact the After Sales Service for assistance.
- The pump must be supplied by a residual current device with a nominal residual operating current $\leq 30\text{mA}$.
- This Class III electrical device (the robot) is supplied with an independent power supply cabinet. The robot alone can only be used with the supplied control box.
- Do not use an extension cord to connect the appliance ; connect appliance to appropriate socket.
- When the mains plug is connected to the electrical installation, Under no circumstances should you lift, transport or turn over the robot.
- Before carrying out any operations, check that :
 - The voltage indicated on the appliance information plate corresponds to the mains voltage.
 - The power grid is adapted to the power requirements of the appliance, and is grounded.
 - The plug (where applicable) is suitable for the socket.
- In the event of abnormal operation, or if the appliance emits an odour, stop it immediately, disconnect the power supply and contact a professional.
- Before carrying out any maintenance or servicing on the appliance, ensure that it is switched off, that it is completely disconnected from the power supply and that any other equipment or accessories connected to the appliance are also disconnected from the power supply.
- Do not disconnect and reconnect the appliance to the power supply during the operation.
- Do not pull on the power cable to disconnect it from the power supply.
- If the power cable is damaged, it should only be changed by the manufacturer, an authorised representative or a repair shop.
- Do not service or maintain the unit with wet hands or if the unit is wet.
- Before connecting the device to the power source, check that the terminal block or power outlet to which the device will be connected is in good condition and not damaged or rusted.
- Do not drop the floating cable plug into water, it is not waterproof. Do not drop it on the ground as this could damage it.
- In stormy weather, unplug the appliance to prevent it from suffering lightning damage.

SPECIFICATIONS " Pool vacuum Robots"

- The cleaner must operate in pool water with a temperature of between 10°C and 35°C.
- To avoid possible injury or damage to the cleaner, do not operate the cleaner out of the water.
- Do not use the cleaner when anybody, especially children or pets, is in the pool.
- Do not use the cleaner during shock chlorination in the pool.
- Do not leave the cleaner unattended for an extended period.

WARNING REGARDING THE USE OF A ROBOT IN A LINER POOL

- Before installing the new cleaner, carefully inspect the pool lining. If the liner has eroded in some areas, or if you notice gravel, folds, roots or corrosion caused by metal beneath the liner, or if you notice that the surface (bottom and walls) is damaged, do not install the cleaner before performing the necessary repairs or before having the liner replaced by a qualified professional. The manufacturer may not be held liable in any way for damage caused to the liner.
- The surface of certain vinyl patterned surfaces can wear rapidly and the patterns disappear on contact from objects such as cleaning brushes, toys, inflatable buoys, chlorine distributors and automatic pool cleaners. The decoration on some vinyl surfaces can be scratched or worn by basic friction such as through the use of a pool brush. The colours of certain patterns can so also be erased during use or when in contact with objects in the pool. The manufacturer may not be held liable for the erased patterns, wear or scratching of vinyl surfaces, which are not covered by the warranty.

WARNING REGARDING THE USE OF A ROBOT IN A STAINLESS STEEL POOL

- The surface of some stainless steel pools can be very fragile. The surface of these pools can be damaged by the natural rubbing of debris against the liner, caused for example by the wheels, robot tracks or brushes, including electric pool robots. Wear or scratches on stainless steel pools are not the responsibility of the robot manufacturer and are not covered by the limited warranty.

**Product disposal - Environmental protection**

In accordance with the European directive 2012/19/EU on WEEE - Waste Electrical and Electronic Equipment, used electrical and electronic devices must be disposed of separately from domestic waste to promote its reuse, recycling or any other way of recovery, as well as to limit the amount of waste to be disposed of and to reduce waste at the same time. When disposing of this product, follow local waste disposal regulations.

TABLE OF CONTENTS



1 CHARACTERISTICS

5

1.1 | Description

5

1.2 | Technical specifications

5

1.3 | How it works

6

1.4 | Pool preparation

6



2 INSTALLATION

7

2.1 | Trolley assembly

7

2.2 | Robot unpacking

8

2.3 | Robot immersion

8

2.4 | Electricity supply connections

9



3 USAGE

9

3.1 | Starting the cleaning cycle

9

3.2 | Use in automatic mode

10

3.3 | Use in manual mode

11

3.4 | Ending the cleaning cycle

12



4 MAINTENANCE

12

4.1 | Filter bag cleaning

12

4.2 | Preventive maintenance

13

4.3 | Wintering

13



5 TROUBLESHOOTING

14

5.1 | Appliance behaviour

14

5.2 | User alerts

15

EN



Advice : to facilitate contact with your dealer

- Make a note of your distributor's contact details to make it easier to find them, and fill in the product information on the back of the leaflet, which your distributor will ask you to provide.



1 Characteristics

1.1 | Description

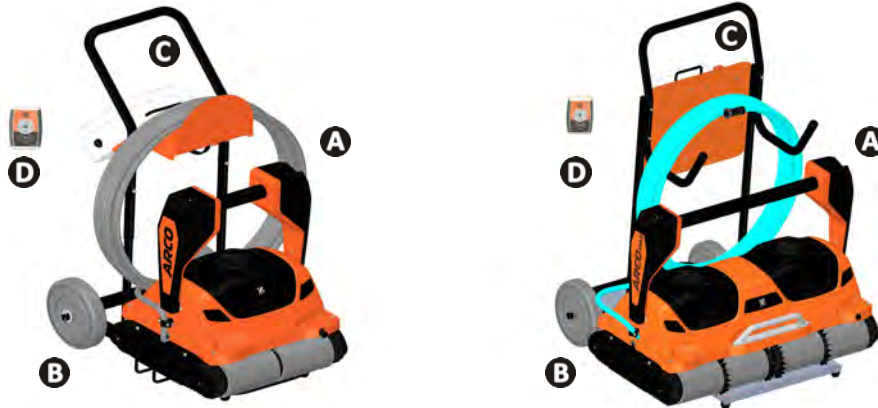

EN

		ARCO	ARCOMAX
A	Robot + floating cable	✓	✓
B	Transport trolley	✓	✓
C	Control box and power supply	✓	✓
D	Radio control	✓	✓

✓ : Delivered

1.2 | Technical specifications

1.2.1 Technical specifications

		ARCO	ARCOMAX
Control box supply voltage		220 - 240 VAC*, 50/60Hz	
Robot power supply		< 30 VDC	
Index of protection	Control box	IPX4	
	Robot	IPX8	
functioning depth (min / max)		0,55 m / 5 m	

* Respect the electrical obligations for the installation of 220V (NFC15-100 section 702).

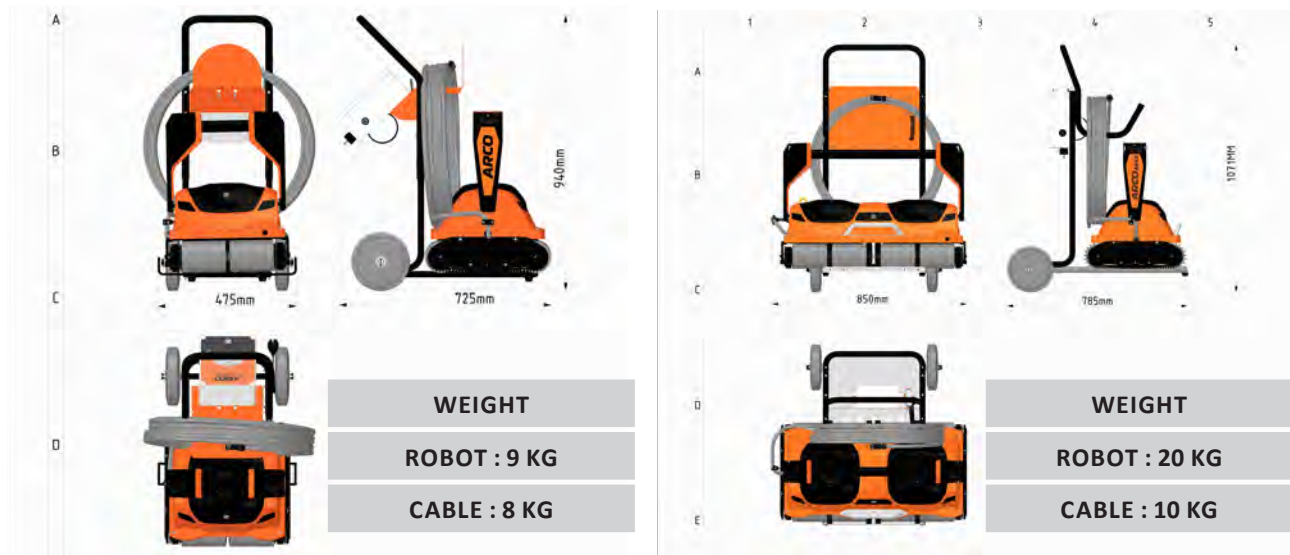

1.3 | How it works

The cleaner is independent of the filtration system and can therefore operate autonomously. It just simply needs to be connected to the mains power supply.

It finds the best route to move around and clean the areas of the pool for which it has been designed (depending on the model/ bottom, walls, water line). Debris is sucked in and stored in the cleaner's filter.

The control box enables the cleaning operations to be started, selected and programmed (depending on the model).

The cleaner has four main units :

- A **cleaning device** containing the suction pump, traction motors, the debris filter, can be washed after use.
- A **control box** containing the electronic elements and the safety transformer, which must be placed at least 3,5m from the water (norm NFC15/100).
- A **remote control** allowing the control of the robot in manual mode.
- A **caddy kit** allowing the appliance to be moved from its storage location to its start-up location.

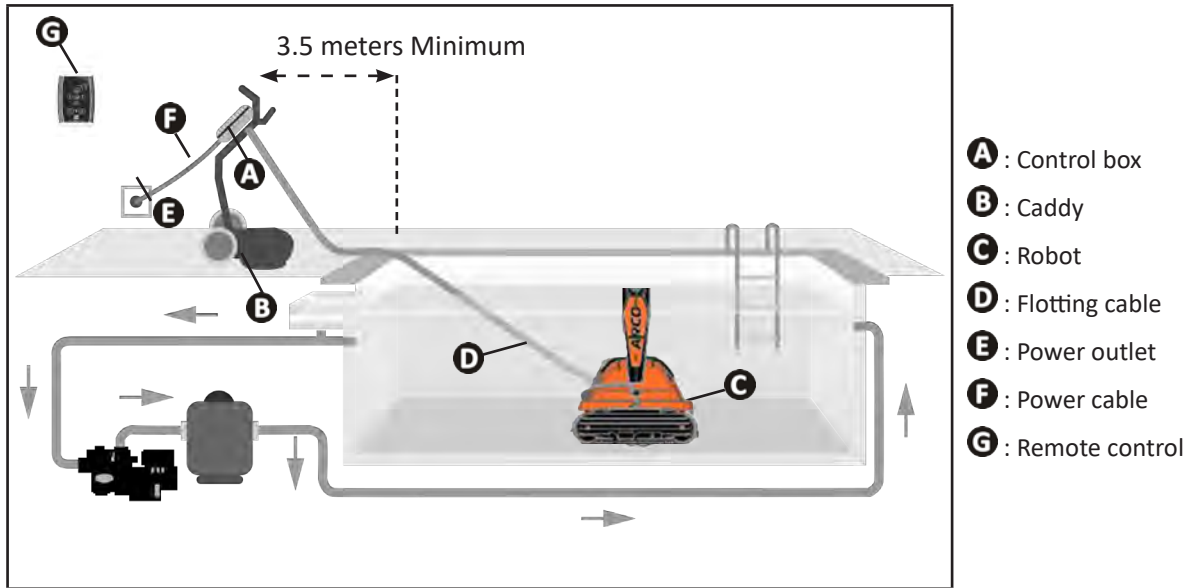

EN

1.4 | Pool preparation



- This product is intended to be used in pool which are permanently installed. Do not use it in pools which may be dismantled. A permanent pool is built into the ground or on the ground and cannot be easily dismantled and stored.
- This cleaner is not designed to be used in sulphurous water.

- The appliance must function in pool water of the following quality :

Temperature of water	At 10°C and 35°C
pH	At 7,0 and 7,8
Chlorine	At 0,6 and 4 ppm
Salinity level (NaCl) maximum	5000 ppm



2 Installation

2.1 | Trolley assembly



- The cleaner must not roll on the floor to access the pool. It must only be transported on its transport trolley.

ARCOMAX

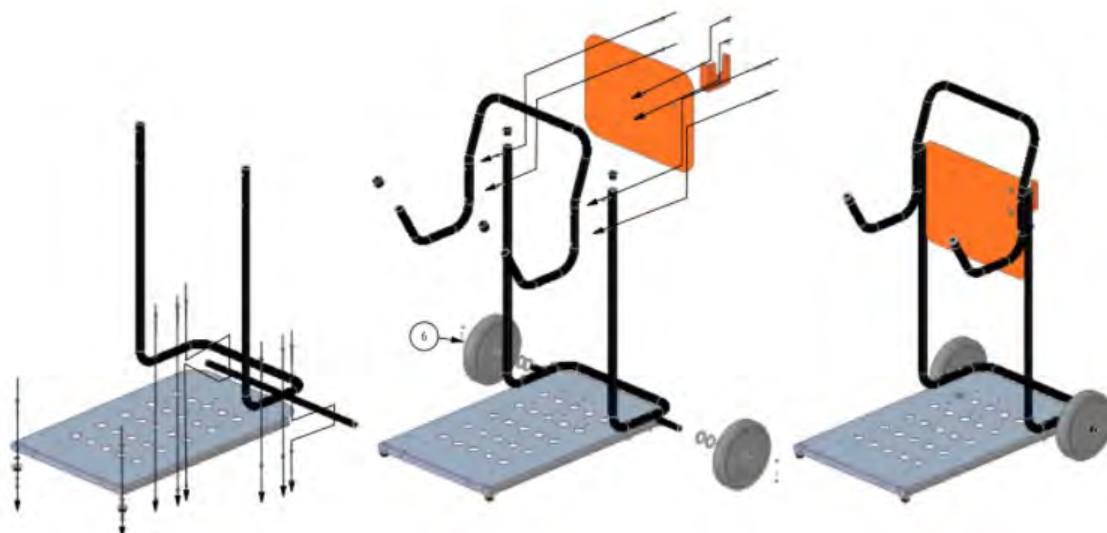

EN

ARCO

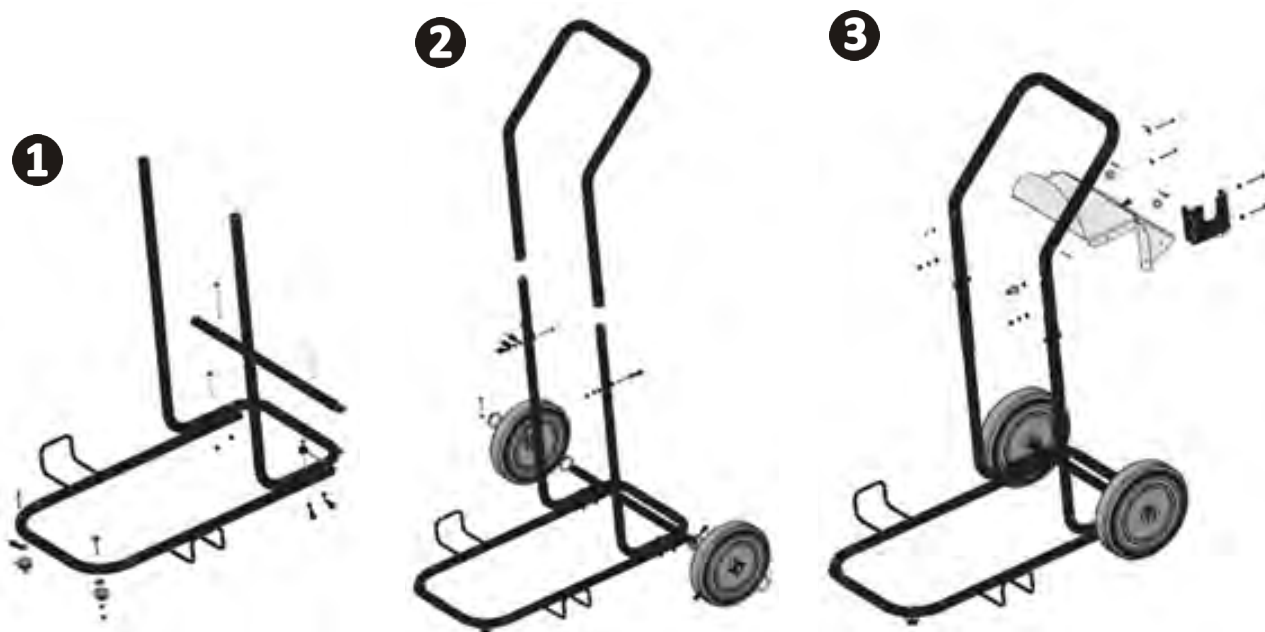

2.2 I Robot unpacking

Before using the pool cleaner for the first time, perform the following steps:

Unwind the cable and stretch it out completely so that it does not have any loops, remove the plastic covers and films before use.

2.3 I Robot immersion



- Do not operate the cleaner out of the water, as this could damage the pump and motor seals and automatically annul the warranty.
- Swimming is not allowed when the cleaner is in pool.
- Moving parts should be checked carefully each time they are used to check that no objects are interfering with their correct functioning, especially in the turbine, tracks, traction belts and brushes.
- Always use the transport trolley to move the robot from its storage location to its start-up location : the robot must not roll on the ground to reach pool.
- Place the control box above the water level of pool and any nearby pools or water supply, at least 30 cm above the ground and 3.5 meters from the pool edge. Protect from rain and splashes and do not expose direct to sunlight.
- The control box is waterproof to splashing water but must not be immersed in water or any other liquid. It must be placed outside the volume 0, 1 and 2, that means more than 3.50m from the edge of the pool according to the country's standard (for France : NF-C15-100- Europe IEC 60364-7-702) The power supply to the appliance must be protected by a 30 mA Residual Current Device and put outside the protection volumes.

- 1 The control box is splash-proof but must not be immersed. It must not be installed in a floodable area. The caddy and the control box must be positioned so that the cleaner can reach all corners of the pool while remaining more than 3,5 meters from the edge.
- 2 Roll out the full length of the cable alongside the pool to avoid the cable becoming tangled during immersion.
- 3 Position yourself one third of the length of pool for immersion of the cleaner.
- 4 Place the cleaner vertically into the water, hold it by the handle.
- 5 Move it slightly in all directions so that the air contained in the cleaner escapes (return it if necessary).
- 6 Unroll enough cable in the water so that the robot can move around the pool. The rest of the cable remains spread out at the edge of pool.
- 7 It is essential that the appliance sinks on its own, settles on the pool bottom and is not moving before starting it.

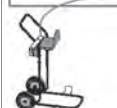
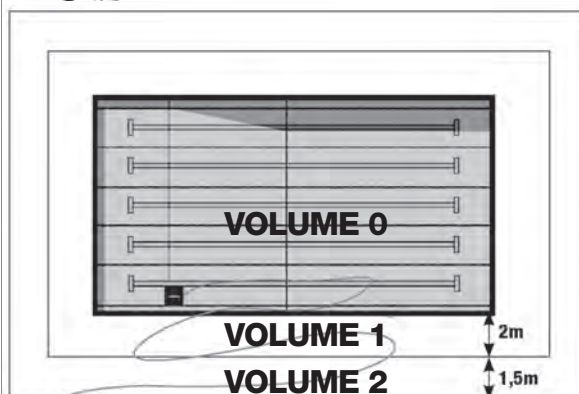
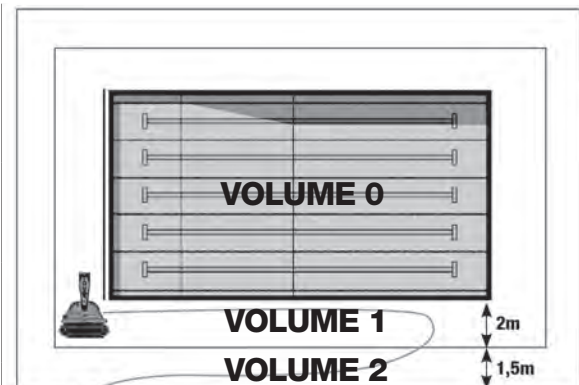

Tip for easy cleaning :

The cleaner is equipped with PVA brushes : wait until they are sufficiently humid and softened to let it sink to the bottom of pool (many minutes if brushes are very dry or new).

2.4 | Electricity supply connections



To avoid the risk of electric shock, fire or serious injury, respect instructions :

- Use of an electrical extension is prohibited when connecting the control box.
- Make sure that the electrical socket can be easily accessed at all times and is protected from rain or splashes. If the outlet used is located outdoors, it must be approved for outdoor use.
- The control box is splash-proof but must not be immersed. It must not be installed in a floodable area; keep it at least more than 3.5 metres outside the 0, 1 and 2 volumes and avoid exposing it to direct sunlight.
- Place the control box near the socket.

1 Connect the floating cable to the control box using the round plug, carefully (the plug is fragile and unsealed) and lock the connector.

2 Connect the control box to the mains and wait 10 seconds (system initialization): the LEDs light up and only the "bottom only" mode remains lit.

3 Now the robot can be used in manual or automatic mode, see "**3** Usage".



3 Usage

3.1 | Starting the cleaning cycle



- **Never start appliance out of the water. In this case, stop it immediately, see "3.2.2 Start and stop cleaning cycle".**
- **Never use the cleaner in water where you cannot see the bottom or where there is too much algae. Do not use the cleaner to mix or suck up chemicals from the bottom of pool.**







To avoid risk of injury or material damage, follow these instructions :

- Bathing is prohibited when the appliance is in pool.
- Remove all objects from surface (swim lines...) or at the bottom of pool (cages, underwater games, toys, tools, stones, branches..) in order not to block the operation of the cleaner and not to damage the appliance.
- Do not use the appliance during shock chlorination in pool, wait until the chlorine level has reached a recommended value before immersing the cleaner.
- Do not use appliance if a roller shutter is closed.
- When pool is dirty, especially during start-up, remove very large debris with a landing net in order to optimise performance of the appliance.
- In the running-in period, it is recommended that each manual function is performed for at least two minutes before starting any automatic programming.
- Keep moving parts away from floating cable so that they never come into contact. The floating cable must never be under the cleaner.

- Use the cleaner as often as possible to enjoy a clean pool. The filter bag will become clogged less fast.
- Remove or pull up wall ladders if possible.
- For better cleaning of pool floor, use the robot when peoples (or animals) have been out of pool for some time and the dirt has completely dropped to the ground.

➤ 3.2 I Use in automatic mode

3.2.1 Cleaning cycle selection

The robot has 4 modes	
	Automatic "express" programme : Background only: Shorter cycle time, faster movement of the unit and no wall rise.
	Optimised" automatic programme : Bottom + walls Scans the pool and adapts the robot's movement according to the self-calculation and the pool's dimensions
	Delayed start : Bottom only Cleaning equivalent to an automatic "express" programme but with a start time of 2 hours after the start button is pressed
	Delayed start : Bottom + walls Cleaning equivalent to an automatic "optimised" programme but with a start time of 2 hours after the start button is pressed



EN



- Use the delayed start function to allow time for the impurities to sink to the bottom of the basin before the cleaner starts the programme.
- There are certain pools where the form, the bottom of the pool (central island, high height of the bottom outlet...) or environmental data such as the temperature (water at 10°C...) or the chemical nature of the water (very high level of salinity (NaCl), permanent proliferation of algae...) mean that the cleaner will not be able to operate in automatic mode, manifesting itself in a very short daily programme.
- Contact us for more details.

3.2.2 Start and stop cleaning cycle

To start a cycle :

-  Make successive long presses by pressing **(MODE)** to select the programme : corresponding LED lights up.
-  Make a long press on **(▶)** to start the cycle. The LED corresponding to the program remains lit for the duration of the cycle and the button **(▶)** flashes.

The cleaner then starts to move and reaches the opposite side of pool.

To stop a cycle :

- Make a long press on **(■)** : LED lights up.
- Or disconnect the cleaner.



- It is possible that cleaner may not move in a straight line due to cable movements, water turbulence, obstacles, etc.
- Use of the radio control is not possible during the automatic mode, see "3.2.2 Start and stop cleaning cycle" to stop the cycle and switch to manual mode.
- Wall rise is set at the factory. The function can be changed during a factory service or by a distributor with access to appliance.

➤ 3.3 I Use in manual mode

Manual mode allows the user to control the robot :

- With radio control,
- With a mobile phone on which corresponding application has been installed.



- If the cleaner is in automatic mode, switch to manual mode by pressing **STOP**.









3.3.1 Use with radio control



- **Radio control is not waterproof, do not immerse it in water or leave it in the sun (heat can damage the module).**

- Point radio control towards the front of the cleaner (identified by Zodiac logo) to use it.
- 4 LEDs of the cleaning programs flash if button  is flashes, the cleaner is not available to start.

EN

	Forward Additional support : alternate between fast and normal speed
	Left turn Press and hold for duration of the desired rotation
	Right turn Press and hold for duration of the desired rotation
	Reverse gear Additional support : alternate between fast and normal speed
	Battery indicator Lights up with each press
	Immediate start of an automatic Bottom only program
	Immediate start of an automatic Bottom and Walls
	- Stop the cleaner to remove it from water or engage automatic mode - Exit automatic mode and switch to manual mode



3.3.2 Use with a mobile phone with the application

The application provides same functionality as the radio control and works via Bluetooth®.

To use it :

- Make sure that cleaner is connected to the control box, which is connected to the mains.
- Stand near the cleaner and press « **DISCONNECTED !** ».
- Select appropriate device on the application.
- « **CONNECTED !** » appears : the cleaner can be used in same way as with the radio control, see "3.3.1 Use with radio control".

➤ 3.4 I Ending the cleaning cycle



- To avoid damaging equipment, use only the handle to remove equipment from the water.

The robot stops automatically after one cycle.

- 1 Bring the robot closer by directing it using the radio control or the Bluetooth® application to remove it from the water.

- 2 Switch off the robot by pressing . Unplug the control box from the mains.

- 3 To get it out of the pool, pull it by the handle and no longer by the cable and let the water drain.

- 4 Roll up the cable. If a twist occurs on the cable. Be careful not to drop the cable plug into the water.

- 5 To better maintain your filtration, we recommend that you immediately remove the filter holder and filter bag. (see "4.1 I Filter bag cleaning"), Wash them with fresh water and rinse your robot.

- 6 Then store it with the control box away from sunlight and any splashes.



EN



4 Maintenance



To avoid serious injury :

- Disconnect the cleaner electrically.

➤ 4.1 I Filter bag cleaning

- 1 Switch off the cleaner from the control box.

- 2 Turn the cleaner over.

- 3 Unlock 4 latches (**A**).

- 4 Remove black filter holder.

- 5 Open the filter bag and clean it with a strong jet of clean water or, if necessary, with slightly soapy water (in this case, rinse it thoroughly). In case of heavy soiling, remove the filter bag from its holder, rinse it and put it back on the filter holder.

- Do not wring out the filter bag. Do not put it in the washing machine. Do not clean with a high pressure cleaner.

- 6 Replace the filter bag and reassemble the filter holder, observing the direction of assembly. Lock 4 latches, do not force.

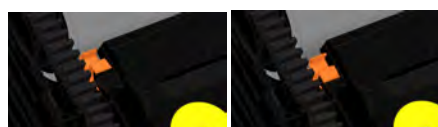
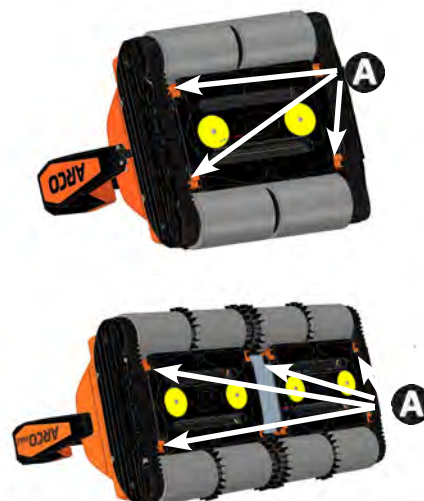

Loquet open

Loquet closed

➤ 4.2 I Preventive maintenance



- **The cleaner is not adapted for use in sea water.** If used in salt water, wash it thoroughly with clean water each time it is removed from the water and have any parts that may be corroded checked by a technician at the end of the season.

In order to preserve the integrity of the appliance and to ensure its optimum performance level :

- Clean the cleaner regularly with clean water and check and/or remove any waste trapped in the drive or turbine. No external mechanical parts require lubrication or special maintenance.
- Periodically clean the stainless steel detectors on the side of the float arm using a water-vinegar solution or other descaling agent. Do not use strong acids.

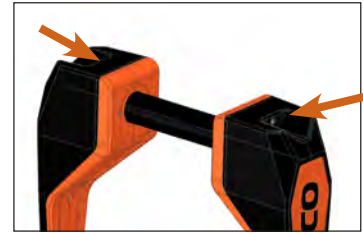

- Carry out annual end-of-season maintenance to avoid deposits and deterioration from water and dirt and to save money in the long term.
- Carry out a complete cleaning before wintering to remove all foreign bodies and rinse the cleaner with clean water.
- Store the cleaner and the control box protected from light and strong heat (maximum 35°C) in a ventilated and dry place. Never store the cleaner and its control box in a place where the temperature can fall below 0°C. Protect them from freezing.
- Replace worn parts at the dealer or after consulting the dealer.
- The plug of the self-floating cable connecting the robot to the control box is fragile and not waterproof, it must not fall on the ground or into the water. Humidity or traces of limestone can get on the small plugs. Use sandpaper or WD 40 type spray to remove it (recommended frequency: once a quarter).

➤ 4.3 I Wintering

- Store the cleaner in its original packaging.
- Store the cleaner in a ventilated, frost-free room, free of chemicals and acids.

If the robot will not be used for a long period of time, please store it as follows:

- Make sure that there is no more water in the pool cleaner.
- Clean the filter bag thoroughly and put it back in place.
- Rewind the cable without kinks and place it on the trolley.
- Store the pool cleaner in a protected place either on its trolley or simply upside down (wheels up).



5 Troubleshooting







- If a problem occurs, before you contact your retailer, please carry out these few simple checks using the following tables.
- If the problem continues, contact your retailer.
-  : Actions to be performed by a qualified technician only.









Despite careful consideration of possible robot trajectories, the cable may twist due to the shape of the pool, obstacles, a specific water flow in the pool or other external factors. This is not a failure of the device. Remove the robot from the water and unwind the cable to allow the robot to function properly.

5.1 I Appliance behaviour

Behaviour	Possible causes	Solutions
The cleaner slips and does not make good trajectories	Filter bag is full or dirty.	<ul style="list-style-type: none"> • Clean the filter bag.
	Although the water looks clear, there are microscopic algae, not visible to the naked eye, which make the ground slippery and prevent the robot from rolling properly.	<ul style="list-style-type: none"> • Lower the pH slightly (between 7 and 7.3) and then carry out a shock chlorination. Do not leave the robot in the water during the shock treatment. Wait 4 hours before using the robot again.
	The cleaner has a problem with its drive, roller or motor, and no more power to allow it to run.	<ul style="list-style-type: none"> • Contact dealer : 
	Belts and tracks are dirty or damaged.	<ul style="list-style-type: none"> • Check the condition of the belts and tracks, clean and/or replace them.
	The robot is equipped with a bottom brush on the filter tray that can block it on a bottom plate or reduce its ability to climb the wall.	<ul style="list-style-type: none"> • Remove the bottom brush clipped to the filter tray (to be kept in case of need for floor cleaning only).
The cleaner does not make any movements	The cleaner is not powered correctly.	Check that : <ul style="list-style-type: none"> • The socket to which the control box is connected is well supplied. • The robot is connected to the control box before connecting the control box to the mains. • The self-floating cable is properly connected to the control box.
Cleaning efficiency seems to decrease	The cleaner does not work properly.	<ul style="list-style-type: none"> • Check that the filter is not dirty, saturated or punctured. • Check that the suction pump is working and that the impeller is not blocked by an object. • Check the condition of the brushes and wheels. • Check that the cable is not too twisted or looped during operation.
	It may happen that a part of the pool is not perfectly cleaned after the automatic programme of the robot has been executed.	<ul style="list-style-type: none"> • If, at the end of the work cycle, the pool still needs to be cleaned, restart the automatic programme but from the opposite wall. The manual mode can be used to complete the cleaning in a very short time.
	The tracks of the robot may leave rubber residues during the first few passes of the robot.	<ul style="list-style-type: none"> • Clean the belts and tracks. • Clean the rubber residues with a sponge.

The robot does not or no longer climbs the walls	The filter system is saturated or dirty and the saturation sensor is illuminated (red): 	<ul style="list-style-type: none"> • Clean filter. • Even if the filter is not full, invisible micro debris can saturate the filter and make it impossible to raise the wall.
	The filter system is saturated or dirty and the saturation sensor is not switched on : 	<ul style="list-style-type: none"> • Sometimes the sensor does not turn on when the filter seems full. This is possible when the cleaner only collects large debris, so the filtration will remain in function. Empty the filter to ensure the wall rises.
	When the filter is saturated, the cleaner can no longer climb the walls and switches to Bottom only mode.	<ul style="list-style-type: none"> • Clean filter. • Even if the filter is not full, invisible micro debris can saturate the filter and make it impossible to raise the wall.
	Although the water looks clear, there are microscopic algae in your pond, not visible to the naked eye, which make the walls slippery and prevent the cleaner from climbing.	<ul style="list-style-type: none"> • Shock chlorinate and lower the pH slightly (between 7 and 7.3). Do not leave the robot in the water during the shock treatment. Wait 4 hours before using the robot again.
	The cleaner has a problem with its drive, belt, track or motor, and no longer has enough power to climb.	<ul style="list-style-type: none"> • Contact dealer : 
	Dirt and debris tend to settle on the floor of the pool, climbing the walls is sometimes unnecessary and this function may have been excluded at the request of the programming.	<ul style="list-style-type: none"> • Wall climbing is impossible.

➤ 5.2 I User alerts

Flashing LED : 	Solutions
  	<ul style="list-style-type: none"> • Clean filter. • Even if the filter is not full, invisible micro debris can saturate the filter and make it impossible to raise the wall.
 Touch  flashing	<ul style="list-style-type: none"> • Check that the robot is flat. • Check that the robot is immersed.

If the problem persists, contact the dealer : 

Votre revendeur
Your retailer

Modèle appareil
Appliance model

Numéro de série
Serial number

Pour plus d'informations, enregistrement produit et support client :
For more information, product registration and customer support:

www.zodiac.com

