

AQUA  
**SPHERE**

# AQUASPHERE INVERTER CONTROLLER





EN - INSTRUCTIONS MANUAL



CONTENTS

- 1. IMPORTANT SAFETY INSTRUCTIONS .....1
- 2. TECHNICAL DATA .....4
- 3. BEFORE INSTALLATION .....5
- 4. CONNECTING TO POOL PUMP .....6
- 5. SETTINGS & OPERATION .....10
- 6. PROTECTION & ERROR CODES .....13
- 7. EXCLUSIONS .....14
- 8. DISPOSAL .....14

SAFETY SYMBOLS

	Read and keep the manual in a safe place
	Warning
	Caution: Risk of electrical shock
	Do not touch the heat sink
	e- Waste: Dispose at recycling centre



# 1. IMPORTANT SAFETY INSTRUCTIONS



## IMPORTANT SAFETY, INSTALLATION AND MAINTENANCE INFORMATION

*The complete manual can be read and downloaded as a PDF file from the website [www.aquaspheremanuals.com](http://www.aquaspheremanuals.com)*



To make the best use of this energy saving device and to avoid potential risk of fire, electrical shock, SERIOUS injury to people or damage to property, please read this user guide carefully before installation and keep it for future reference.

- All assembly, electrical installation and maintenance work must be carried out by qualified, authorized personnel who have carefully read the installation and service instructions.
- This appliance is not intended for use by persons (including children) with reduced physical, sensory or mental capabilities, or lack of experience and knowledge, unless they have been given supervision or instruction concerning use of the appliance by a person responsible for their safety.
- Children should be supervised to ensure that they do not play with the appliance.
- This appliance can be used by children aged from 8 years and above and persons with reduced physical, sensory or mental capabilities or lack of experience and knowledge if they have been given supervision or instruction concerning use of the appliance in a safe way and understand the hazards involved.
- Children shall not play with the appliance.
- Cleaning and user maintenance shall not be made by children without supervision.
- Our product may only be assembled and installed in pools compliant with standards IEC/HD 60364-7-702 and required national rules. The installation should follow standard IEC/HD 60364-7-702 and required national rules for swimming pools.

Consult your local dealer for more information.

- The inverter controller cannot be installed in Zone 0 (Z0) or Zone 1 (Z1). To see drawings refer to page 2
- The unit should be connected to an alternating current supply (see data on the inverter controller's plate) with an earth connection, protected by a residual current device (RCD) with a rated residual operating current that does not exceed 30 mA.
- A disconnecter must be fitted to the fixed electrical installation in accordance to the installation regulations.
- Only ONE pump can be connected to the inverter. Do not connect any other appliance to the output.

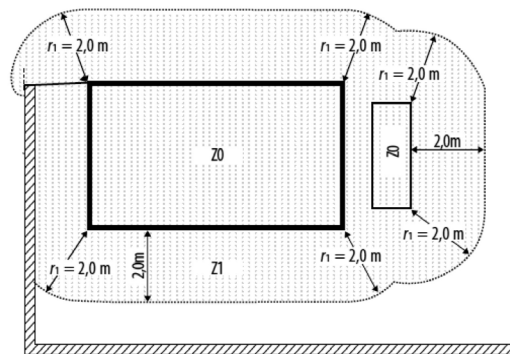
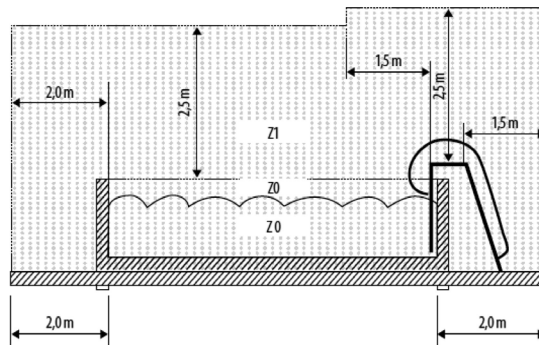
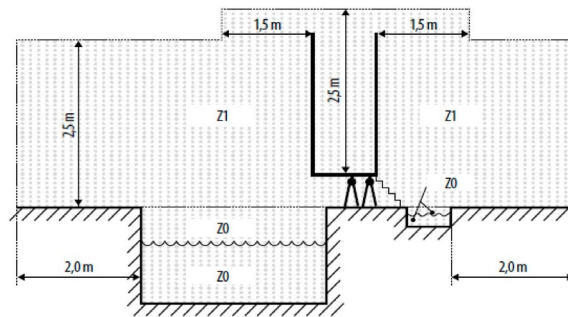



This device can ONLY be used with pool pumps with permanent split capacitor motor. The schematic diagram below shows a typical single speed swimming pool pump motor.

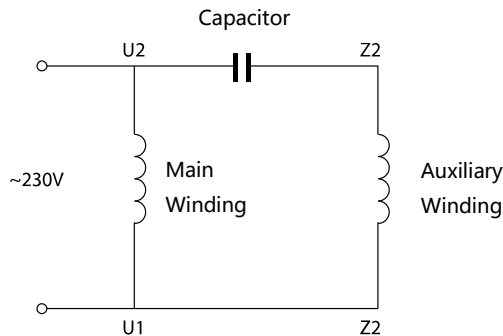

Fig.1

1.1 It is NOT compatible with:

- a. Single (Three) phase motors with centrifugal switch.
- b. Pool pump motors with start relays or switch.
- c. Series or DC motors.
- d. Pool pump motors with faults in their rotors or capacitors.
- e. Shaded-pole asynchronous motors.

1.2 An RCD with a rated residual current not exceeding 30mA must be used with this product.



If you are not sure of the compatibility of your pool pump with this device, please contact your supplier or manufacturer before proceeding with installation.

## 2. TECHNICAL DATA

### 2.1 Aquasphere Inverter controller 1.1kW

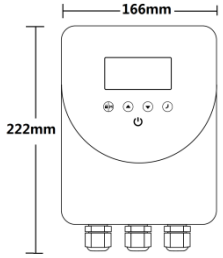
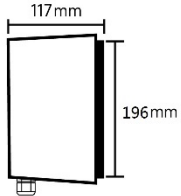
Model	75947	<b>Dimensions</b> 
Input power	1 phase AC	
Input voltage	220-240V	
Input frequency	50Hz	
Output power	Max 1.1kW	
Output Voltage	1~, 0-240V	
Pump type	Single phase	
Max. current	Max 6A	
Speed range	1200~2900 rpm	
Cooling	Ventilation	
Net Dimension (L*H*W)	222*117*166mm	

### 3. BEFORE INSTALLATION



Upon receipt of this device, check for damage to the packaging or product. DO NOT PROCEED with installation if any damage is found; contact your supplier.  
Do not use extension leads with the device. This can pose a danger particularly in the vicinity of a swimming pool.

Make sure the place you choose for installation meets the following conditions:

- Ambient temperature from -10~40°C
- 45 to 90 percent relative humidity, non-condensing
- Less than 1000m above sea level
- Keep out of direct sunlight
- Good ventilation

For efficient cooling, please make sure it is installed with a minimum clearance surrounding it (Fig.2)

Blocked ventilation or an enclosed space with limited air flow may cause overheating or potential operational failure of the inverter.

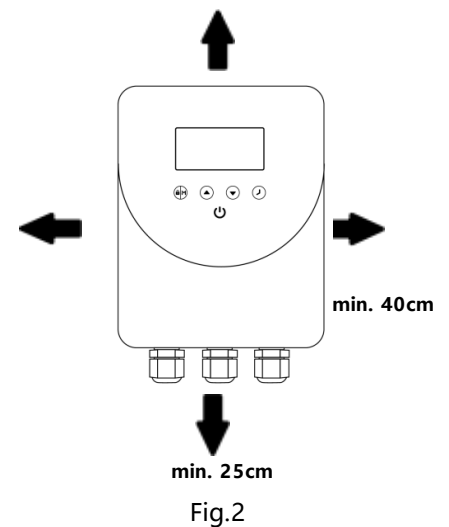

## 4. CONNECTING TO POOL PUMP



Please follow these steps and the wiring diagram for correct connection. The warranty may be compromised if the device is not installed in accordance with instructions described in this manual.

Only ONE pump can be connected to the inverter. Please do not connect any other appliance to the output.

Mark the hole locations on the wall, drill and insert the expansion plugs supplied, fit the screws and hang the device on the screws.

4.1 Turn off all electrical supply to the pool pump, unplug it from the main switch or at the chlorinator which provides electrical power to the pump.

4.2 Plug the pool pump into the device's power outlet (marked PUMP CONNECTION ONLY).

It is recommended that the total length of the equipment output line and the swimming pool pump power line shall not exceed 2m.

4.3 Plug the device into the main switch/chlorinator/timer connection where the pump was originally plugged into.

4.4 In order to reduce the impact of electromagnetic interference; please connect the grounding wire, that's fixed on the heat sink, to the pool pump motor (if the output of frequency inverter does not have a plug, it does not need to be connected)

4.5 Switch all power back on.

4.6 Ensure chlorinator/timer is active.

4.7 Now the device is ready to operate



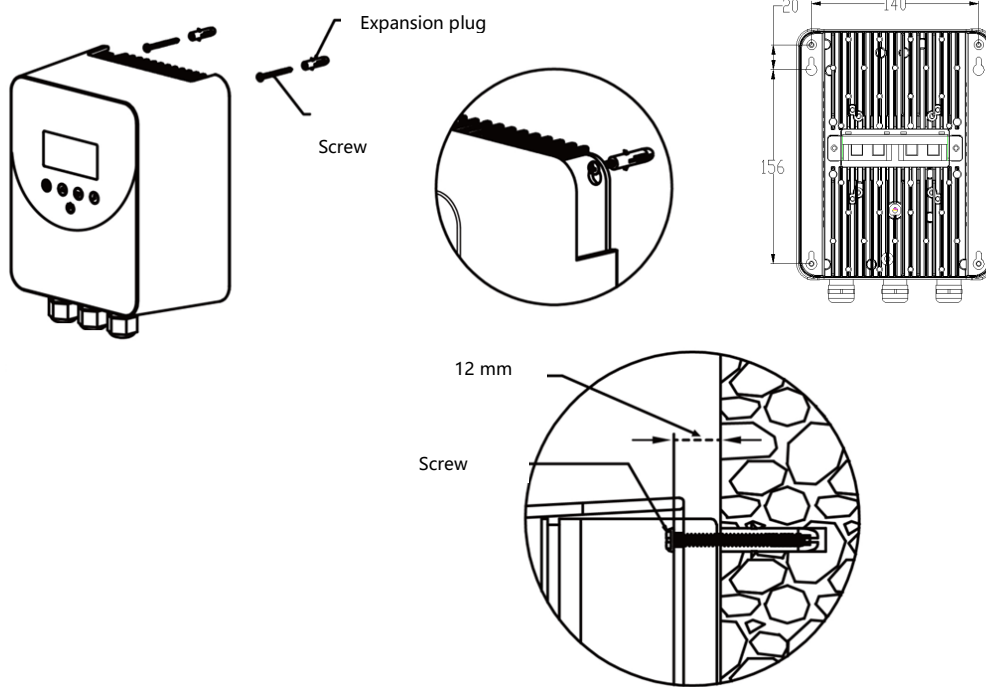

Fig.3

Above figure is for reference only, plug & socket may vary for different countries/regions.

If the pump socket is already included in your device, wire the device as shown in Fig.4 and 5.

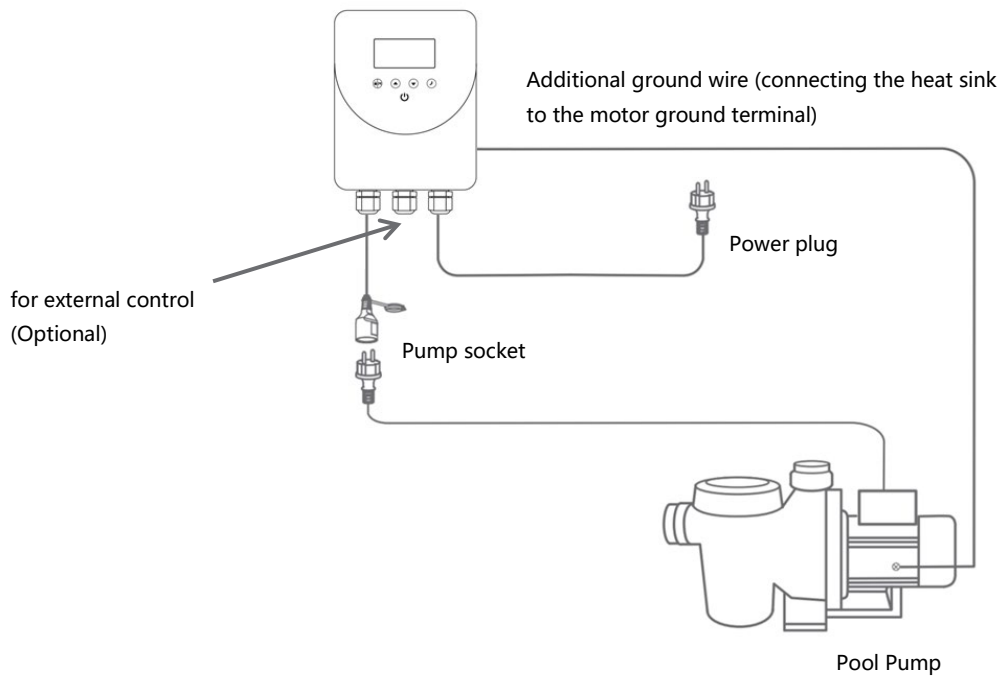

Fig.4

Above figure is for reference only, plug & socket may vary in different countries/regions.

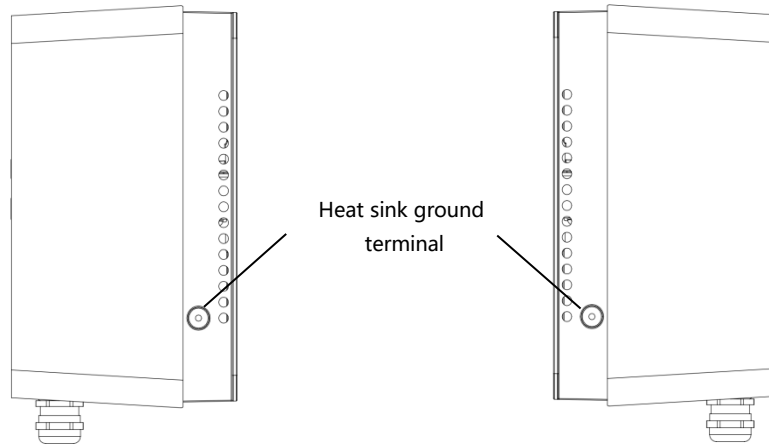

Fig.5 Ground wire terminal diagram

If the pump socket is not included in your device, wire the device as shown in Fig.6 and 7

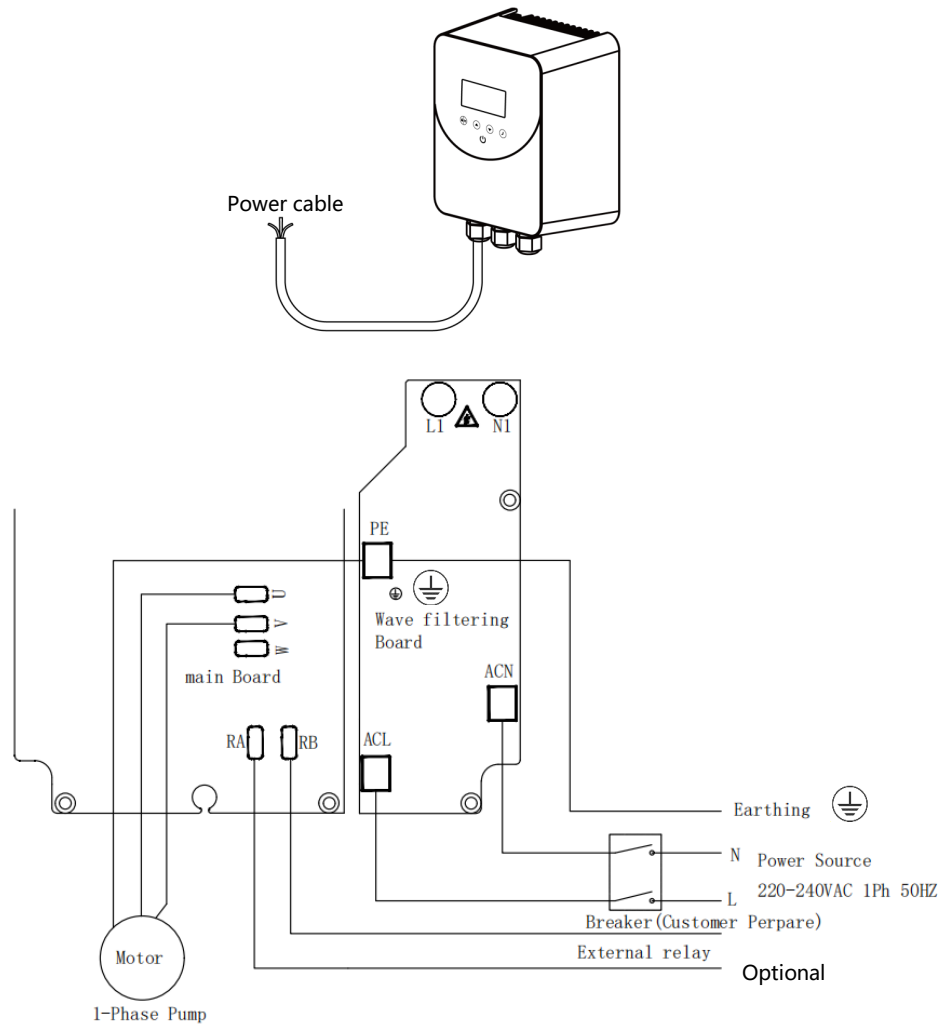

Fig 6 1-ph pump connection diagram

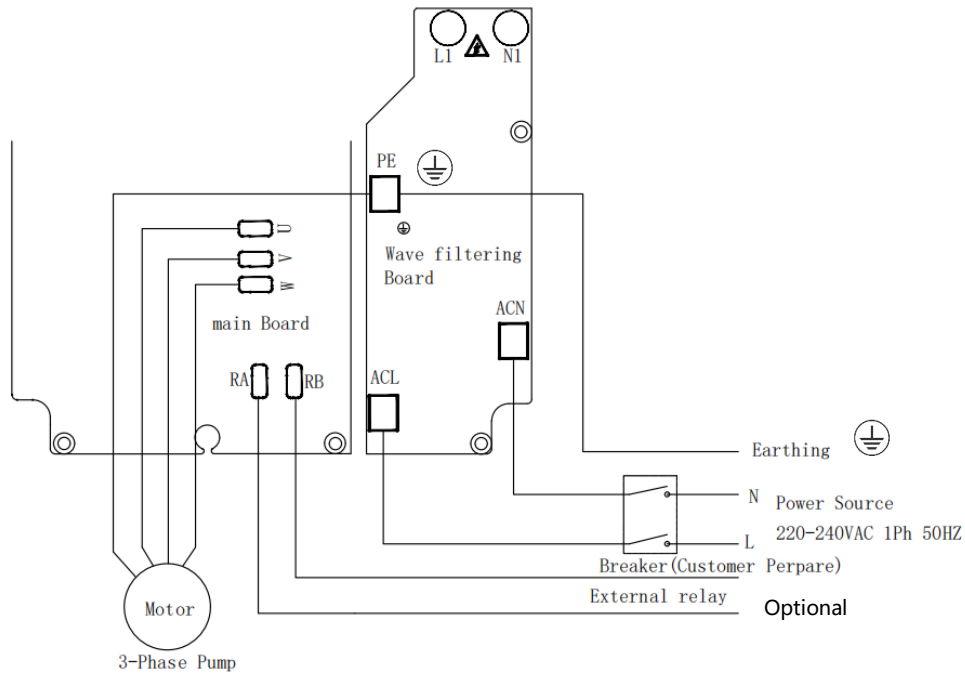

Fig 7 3-ph pump connection diagram



Do not touch the heat sink while the device is in operation or until at least 30 mins after it has been switched off. Keep it out of reach of children.



Because of high voltage conversion components contained in the device, do not try to disassemble or replace any components in case of malfunction or breakdown. Before serving on the unit, wait till the power light turned off or at least 3 minutes after power plug has been plugged off from input supply.



For 3 phase Inverter controller, please connect the pump motor with delta connection.

## 5. SETTINGS & OPERATION

### 5.1 Control panel

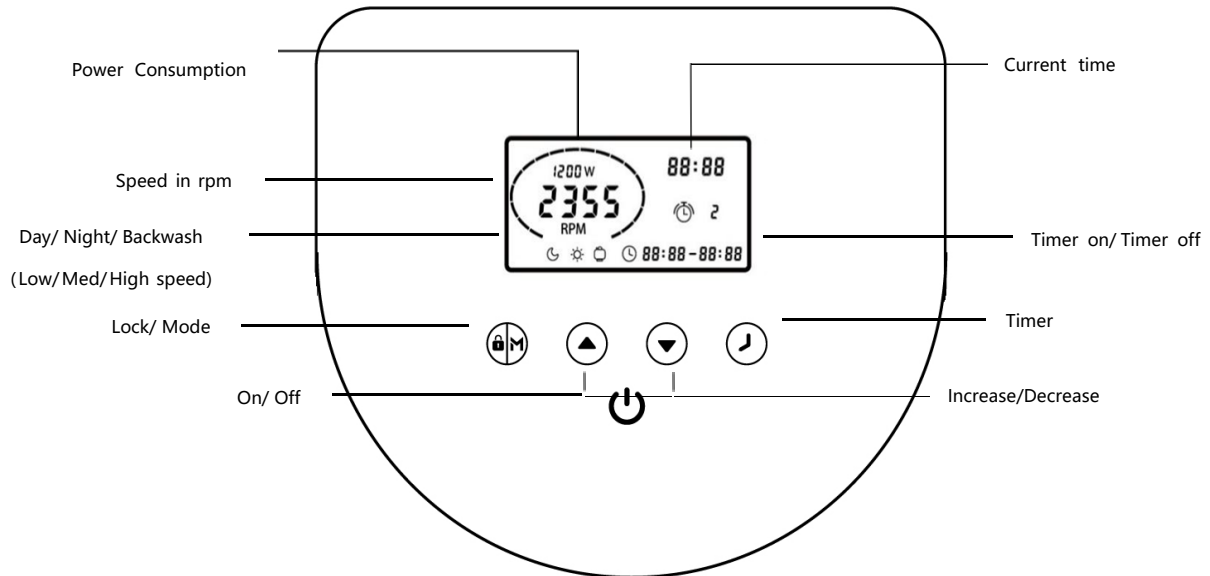



### 5.2 Mode selection

The frequency inverter has 3 modes (speed ranges). You can either run your pump at a constant speed choosing from “M” or set up to 4 timers for daily operation, each with an individual speed.

Mode	Speed range	Default speed
Night (Low)	1200~1650 rpm	1400 rpm
Day (Medium)	1700~2400 rpm	2000 rpm
Backwash (High)	2450~2900 rpm	2900 rpm

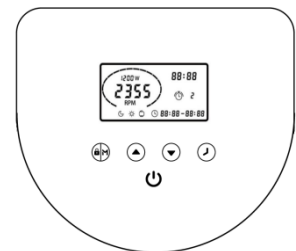
- ① When plugged in, lights up, hold for 3 seconds to unlock the screen. Press to start.
- ② Upon starting, pump will run at maximum speed of 2900 rpm for one-minute self-priming. (This can be increased to 10 minutes – see Parameter settings Section 5.5)
- ③ Press to choose a running speed, use or arrows to adjust by 50rpm to a specific running speed if required.







Once the pump has finished priming, the inverter will automatically switch the pump to the pre-set speed,  indicates the pump is running and showing current rpm and power consumption.





### 5.3 Timer setting

To run the pump at different times or speeds to take advantage of lower electricity tariffs during the night, you can set up to 4 timers.

Step1: Press  to enter timer setting.

Step2: Use  or  to set current time. Press 

to move cursor to the next setting. Press  to choose

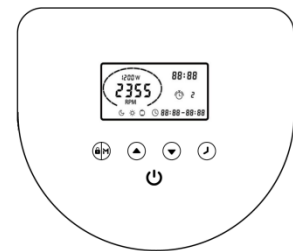

a speed range for timer 1, use  or  to decide on a specific speed if required. Press   to move cursor to previous setting.



Step3: Repeat the above steps to set the other 3 timers.

Step4: Hold  for 3 seconds or wait 10 seconds to save settings automatically.

A flashing  **88:88 - 88:88** indicates the device is waiting for start time.

Step5: Press  or  to check all 4 timers to ensure there are no invalid setting.



\* Any overlapping of timer periods will be considered as invalid and the device will only run based on the previous valid timer setting.

\* During timer setting, if you want to abandon it, hold  for 3 seconds.

**Note:**

\* If inactivate for 1 minute, the screen will lock automatically. Hold  for 3 seconds to unlock the device.

\* The device has power-off memory, operation will resume upon power restoration.

\* Under OFF mode, hold   for 3 seconds to retrieve factory setting.

**5.4 External control (Optional)**

External control can be enabled via the following contacts. However, even if is working via an external controller, pressing  can stop the device.

Please do not apply voltage to these inputs.

PIN	Wire color	Signal description
1	RED	Digital input 4
2	BLACK	Digital input 3
3	WHITE	Digital input 2
4	GREY	Digital input 1
5	YELLOW	DGND
6	GREEN	RS485-A
7	BROWN	RS485-B

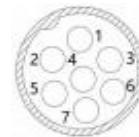

Fig. 8

E.g.: To enable external speed control via digital input, connect one of the digits from PIN 1/2/3 to COM.

When PIN4 is connected with Com, the pump will stop; if disconnected, the digital control will be invalid;

When PIN3 is connected with Com, the pump will run at 2900 RPM; if disconnected, the control priority will be back on panel control;

When PIN2 is connected with Com, the pump will run at 2400 RPM; if disconnected, the control priority will be back on panel control;

When PIN1 is connected with Com, the pump will run at 1200 RPM; if disconnected, the control priority will be back on panel control;

## 5.5 Parameter setting

Under OFF mode, hold ▲▼ for 3 seconds to enter parameter settings.

Parameter	Description	Default setting	Setting range
1	Priming time	1 minutes	0~10min, by 1-minute increments
2	Minimum RPM	1200rpm	1200~2000rpm, by 100rpm increments
3	PIN3	2900rpm	1200~2900rpm, by 100rpm increments
4	PIN2	2400rpm	1200~2900rpm, by 100rpm increments
5	PIN1	1200rpm	1200~2900rpm, by 100rpm increments
6	Self-priming speed	2900rpm	1200~2900rpm, by 100rpm increments

## 6. PROTECTION & ERROR CODES

Item	Code	Description	Analysis
1	E001	Abnormal input voltage	Not faulty
2	E002	Output over current	Not faulty
3	E101	Heat sink over heat	Contact your supplier
4	E102	Heat sink sensor error	Contact your supplier
5	E103	Master driver board error	Contact your supplier
6	E201	Circuit board error	Contact your supplier
7	E202	Master board EEPROM reading failure	Contact your supplier
8	E203	RTC time reading error	Contact your supplier
9	E204	Keyboard EEPROM reading failure	Contact your supplier
10	E205	Communication error	Contact your supplier
11	AL01	Auto speed reduction against high temperature	Contact your supplier

*Note:*

1. AL01 is not an error indication: when it appears, the inverter will automatically switch to a lower speed to self-protect against high internal temperature. When the temperature drops back to 68°C the inverter will resume at the preset speed.
2. When causes for E002/E101/E103 lifts, the device will resume working automatically, however when it appears a fourth time, the device will stop working, to resume operation, unplug the device and plug in & restart again.

## 7. EXCLUSIONS

Under no circumstances should the manufacturer be held liable for any consequences resulting from inappropriate, incorrect installation, or mismatching of the product to pool pumps that are not compatible.

The manufacturer reserves the right to change the specification of the product or its performance or the contents of the User Guide without notice in case of technical upgrade.

## 8. DISPOSAL



This symbol is required by European Community Directive 2012/19/UE on WEEE (Waste Electrical and Electronic Equipment) and means that your appliance must not be thrown into a normal bin. It will be selectively collected for the purpose of reuse, recycling or transformation. Any substances it may contain which are potentially dangerous to the environment shall be eliminated or neutralized. Request information on recycling procedures from your retailer.



AQUA  
SPHERE

# INVERTER CONTROLLER AQUASPHERE





FR - MODE D'EMPLOI



## SOMMAIRE

1. INSTRUCTIONS DE SÉCURITÉ IMPORTANTES .....	17
2. DONNÉES TECHNIQUES .....	20
3. AVANT L'INSTALLATION .....	21
4. RACCORDEMENT À LA POMPE DE PISCINE .....	21
5. PARAMÈTRES ET FONCTIONNEMENT .....	26
6. PROTECTION ET CODES D'ERREUR.....	30
7. EXCLUSIONS .....	31
8. ÉLIMINATION .....	31

## SYMBOLES DE SÉCURITÉ

	Lisez et conservez ce mode d'emploi dans un endroit sûr.
	Avertissement.
	Prudence : risque d'électrocution.
	Ne touchez pas le dissipateur thermique.
	Déchets d'équipements électriques et électroniques : à éliminer auprès d'un centre de recyclage.



FLUIDRA GLOBAL DISTRIBUTION

Avda. Alcalde Barnils, 69 | 08174 - Sant Cugat del Vallés | Espagne

# 1. INSTRUCTIONS DE SÉCURITÉ IMPORTANTES



## INFORMATIONS IMPORTANTES CONCERNANT LA SÉCURITÉ, L'INSTALLATION ET L'ENTRETIEN

*Vous pouvez lire le mode d'emploi complet et le télécharger au format PDF sur le site Web [www.aquaspheremanuals.com](http://www.aquaspheremanuals.com).*



Pour exploiter au mieux ce dispositif d'économie d'énergie et éviter les risques d'incendie, d'électrocution, de blessures GRAVES et de dommages matériels, lisez ce manuel attentivement avant de procéder à l'installation et conservez-le pour toute consultation ultérieure.

- Le montage, l'installation électrique, et l'entretien doivent être effectués par le personnel qualifié et autorisé qui a pris connaissance préalablement des instructions d'installation, de mise en service et d'entretien.
- Cet appareil n'est pas destiné à être utilisé par des personnes (y compris des enfants) présentant des capacités physiques, sensorielles ou mentales réduites ou sans expérience ni connaissances, sauf si elles sont sous la surveillance d'une personne responsable de leur sécurité ou ont reçu de cette dernière des consignes d'utilisation appropriées.

Les enfants doivent être surveillés pour s'assurer qu'ils ne jouent pas avec l'appareil.

- Les enfants à partir de 8 ans et les personnes présentant des capacités physiques, sensorielles ou mentales réduites ou sans expérience ni connaissances peuvent utiliser cet appareil à condition d'être sous surveillance ou d'avoir reçu les consignes appropriées pour une utilisation en toute sécurité et de comprendre les dangers associés.
- Les enfants ne doivent pas jouer avec cet appareil.

L'entretien et la maintenance d'usage de l'appareil ne doivent pas être effectués par des enfants sans surveillance.

- Le produit doit être monté et installé uniquement dans des piscines conformes aux normes CEI/HD 60364-7-702 et aux réglementations nationales en vigueur.
- L'installation doit répondre à la norme IEC / HD 60364-7-702 et à la réglementation nationale relative aux piscines.

Pour plus d'informations, consultez votre revendeur local.

- L'appareil ne doit pas être installé dans une zone 0 (Z0) ni une zone 1 (Z1). Consultez les schémas page 2.

- L'appareil doit être branché sur une alimentation en courant alternatif (reportez-vous aux informations indiquées sur la plaque du produit) avec une prise de terre, protégée par un dispositif différentiel à courant résiduel (DDR) dont le courant résiduel nominal ne dépasse pas 30 mA.

- Un sectionneur doit être installé sur l'installation électrique fixe conformément aux réglementations relatives à l'installation.

- UNE SEULE pompe peut être raccordée à l'appareil. Ne branchez aucun autre dispositif sur la sortie.

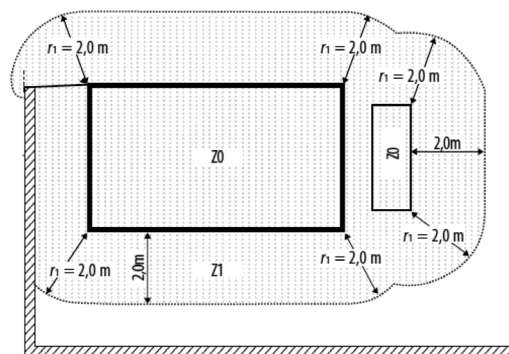
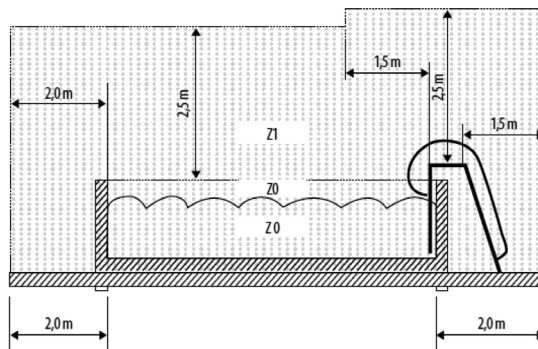
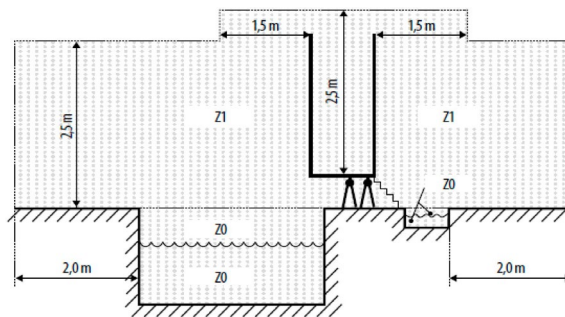



Cet appareil peut UNIQUEMENT être utilisé avec des pompes de piscine équipée d'un moteur à condensateur permanent. Le schéma ci-dessous présente un moteur de pompe de piscine à vitesse unique traditionnel.

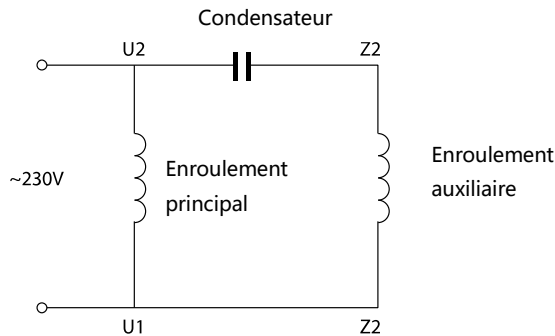

Fig.1

### 1.1 NON compatible avec :

- a. les moteurs (tri-) monophasés à contacteur centrifuge ;
- b. les moteurs de pompe de piscine équipés de relais de démarrage ou de commutateur d'allumage ;
- c. les moteurs série ou à courant continu ;
- d. les moteurs de pompe de piscine présentant des défaillances au niveau du rotor ou du condensateur ;
- e. les moteurs asynchrones à bague de déphasage.

1.2 Ce produit doit être utilisé avec un dispositif différentiel à courant résiduel (DDR) dont le courant résiduel nominal ne dépasse pas 30 mA.



Si vous avez des doutes quant à la compatibilité entre votre pompe de piscine et cet appareil, contactez votre fournisseur ou le fabricant avant de procéder à son installation.

## 2. DONNÉES TECHNIQUES

### 2.1 Inverter Controller Aquasphere 1,1 kW

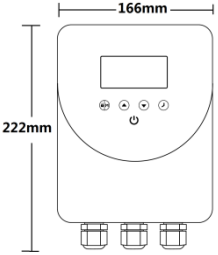
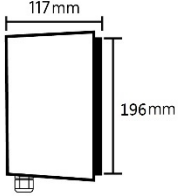
Modèle	75947	Dimensions
Puissance d'entrée	1 phase AC	
Tension d'entrée	220-240 V	
Fréquence d'entrée	50 Hz	
Puissance de sortie	1,1 kW max.	
Tension de sortie	1~, 0-240 V	
Type de pompe	Monophasée	
Courant max.	6 A max.	
Plage de vitesses	1200~2900 rpm	
Refroidissement	Ventilation	
Dimensions nettes (H*P*I)	222*117*166 mm	

oo

### 3. AVANT L'INSTALLATION



Lors de la réception de l'appareil, vérifiez que ni l'emballage ni le produit ne sont endommagés.

**NE PROCÉDEZ PAS** à l'installation si vous détectez un quelconque dommage. Contactez le fournisseur.

N'utilisez pas de rallonges pour brancher l'appareil. Les rallonges représentent un risque, en particulier près d'une piscine.

Vérifiez que l'emplacement d'installation choisi remplit les conditions suivantes :

- Température ambiante située entre -10 et 40 °C environ
- Entre 45 et 90 % d'humidité relative, sans condensation
- Moins de 1000 m au-dessus du niveau de la mer
- À l'abri des rayons du soleil
- Bonne ventilation

Pour un refroidissement efficace, veillez à respecter un espace de dégagement autour de l'appareil lors de l'installation (fig. 2).

Si la ventilation est bloquée ou si l'espace est confiné et mal aéré, l'appareil risque de surchauffer ou de dysfonctionner.

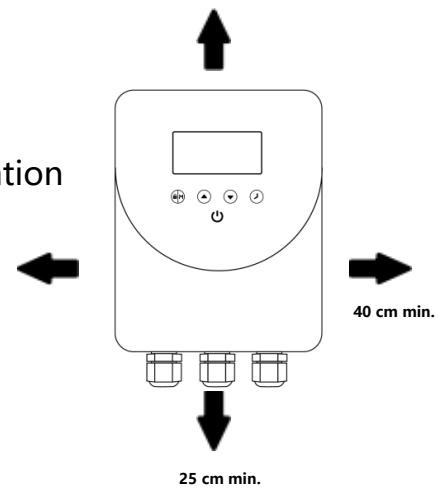

Fig.2

### 4. RACCORDEMENT À LA POMPE DE PISCINE



Pour un raccordement correct, suivez la procédure indiquée et le schéma électrique. La garantie peut être annulée si l'appareil n'est pas installé conformément aux instructions de ce manuel.

UNE SEULE pompe peut être raccordée à l'appareil. Ne branchez aucun autre appareil sur la sortie.

Faites une marque à l'emplacement des orifices sur le mur, percez et insérez les chevilles à expansion fournies, vissez les vis et accrochez l'appareil aux vis.

- 4.1 Mettez la pompe de piscine hors tension, débranchez-la de l'interrupteur principal ou de l'électrolyseur qui fournit le courant électrique à la pompe.
- 4.2 Branchez la pompe de piscine sur la prise de l'appareil marquée PUMP CONNECTION ONLY. La longueur totale du câble de sortie de l'équipement et du câble d'alimentation de la pompe de piscine ne doit pas dépasser 2 m.
- 4.3 Branchez l'appareil sur l'interrupteur principal/l'électrolyseur/le dispositif de programmation sur lequel la pompe était branchée.
- 4.4 Pour réduire les interférences électromagnétiques, branchez le câble de mise à la terre fixé sur le dissipateur thermique au moteur de la pompe de piscine (si la sortie du variateur de fréquence ne dispose pas de prise, il n'est pas nécessaire de le brancher).
- 4.5 Remettez le système sous tension.
- 4.6 Vérifiez que l'électrolyseur/le dispositif de programmation est activé.
- 4.7 L'appareil est prêt à fonctionner.

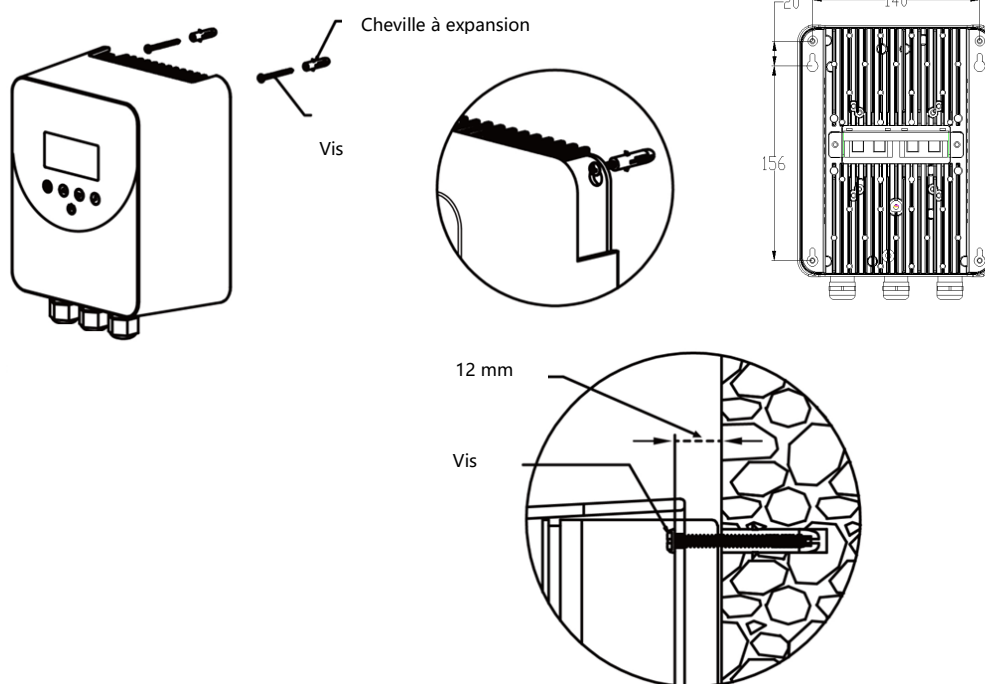

Fig.3

La figure ci-dessus est donnée à titre indicatif uniquement. Les prises peuvent varier en fonction du pays ou de la région.



Si la prise de la pompe est incluse avec l'appareil, branchez l'appareil comme indiqué dans les figures 4 et 5.

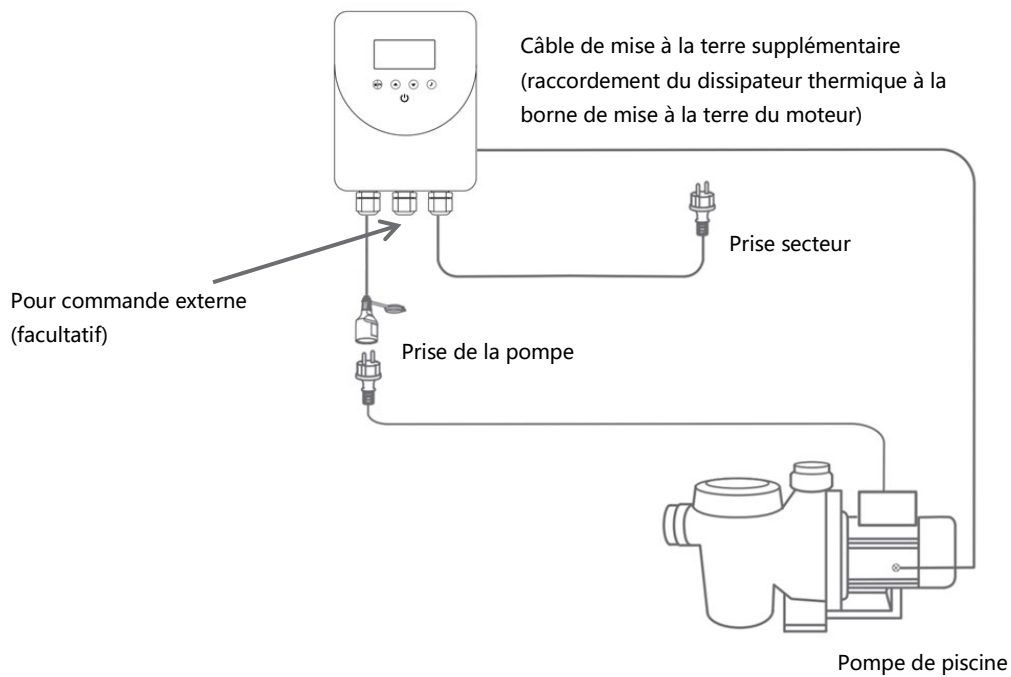

Fig.4

La figure ci-dessus est donnée à titre indicatif uniquement. Les prises peuvent varier en fonction du pays ou de la région.

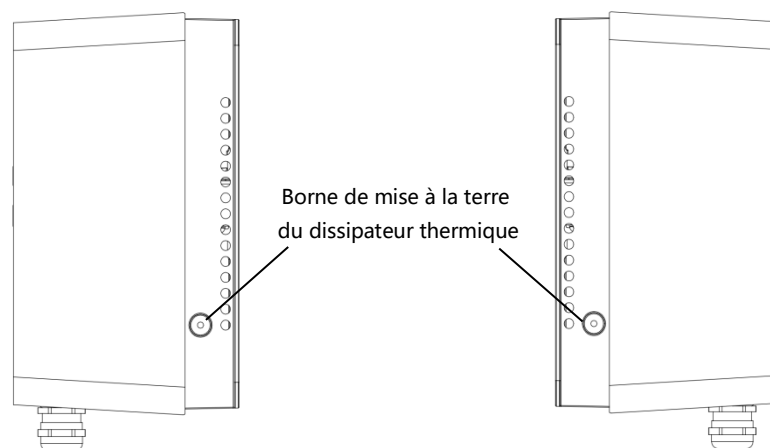

Fig. 5 Schéma de câblage de la mise à la terre

Si la prise de la pompe n'est pas incluse avec l'appareil, branchez l'appareil comme indiqué dans les figures 6 et 7.

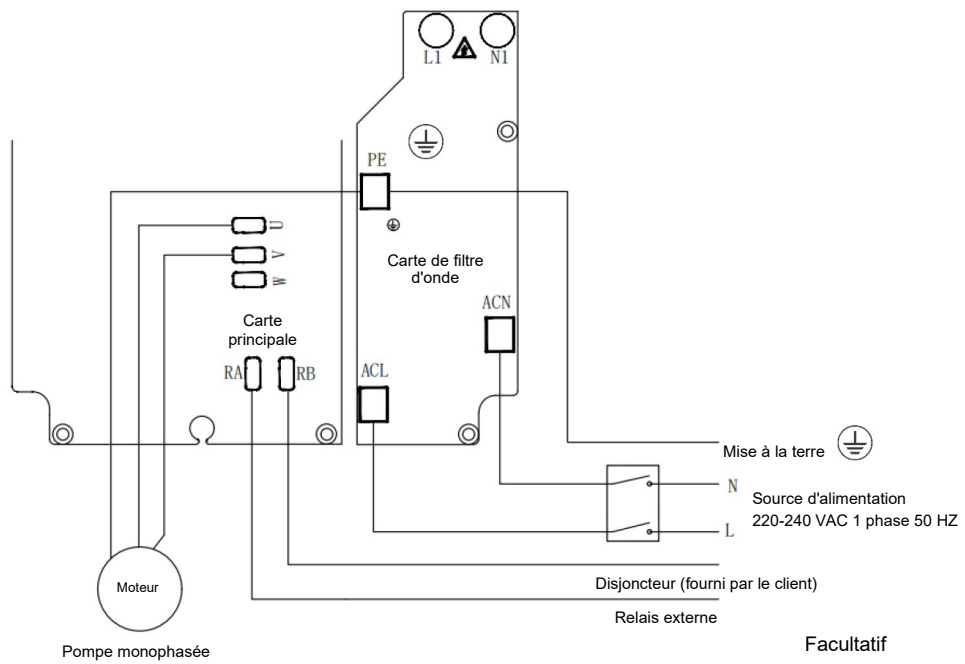
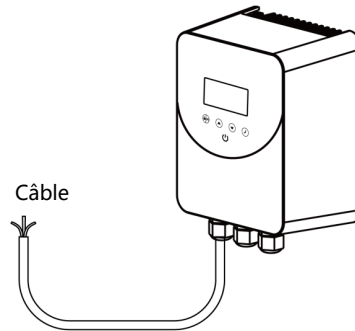

Fig. 6 Schéma de câblage pour pompe monophasée

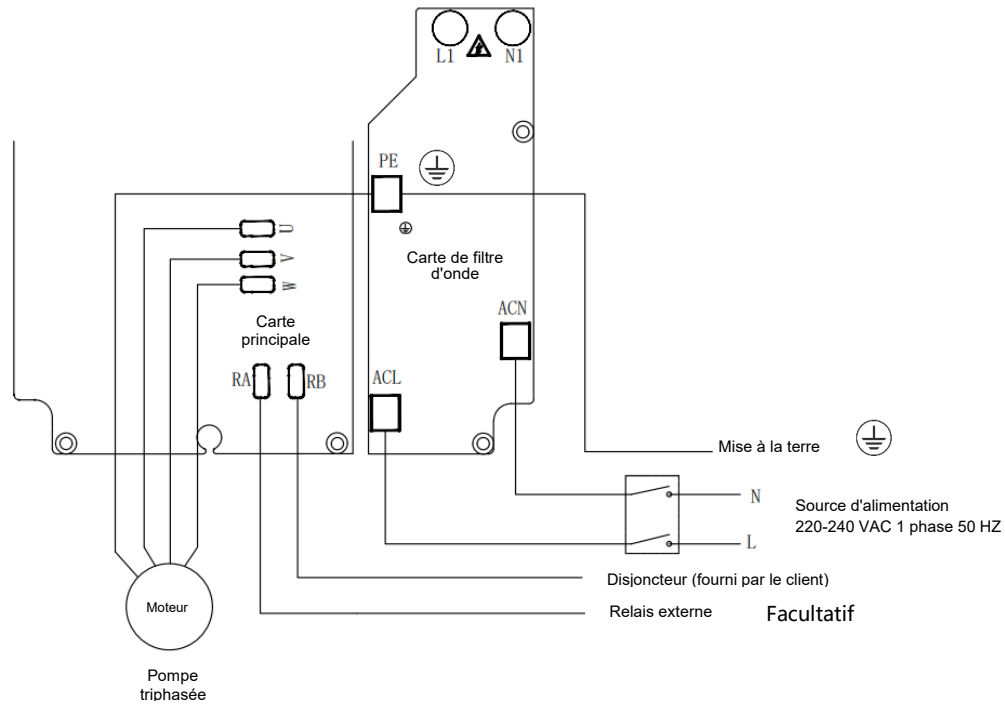

Fig. 7 Schéma de câblage pour pompe triphasée



Ne touchez pas le dissipateur thermique tant que l'appareil est en fonctionnement ou dans les 30 minutes suivant son arrêt. Tenez l'appareil hors de portée des enfants.



L'appareil contient des composants de conversion à haute tension. N'essayez pas de démonter ni de remplacer les composants en cas de dysfonctionnement ou de panne. Avant d'effectuer toute opération sur l'appareil, attendez que l'indicateur de mise sous tension soit éteint ou au moins trois minutes après avoir débranché l'appareil de l'alimentation.



Pour un Inverter Controller triphasé, réalisez un couplage en triangle lors du câblage du moteur.

## 5. PARAMÈTRES ET FONCTIONNEMENT

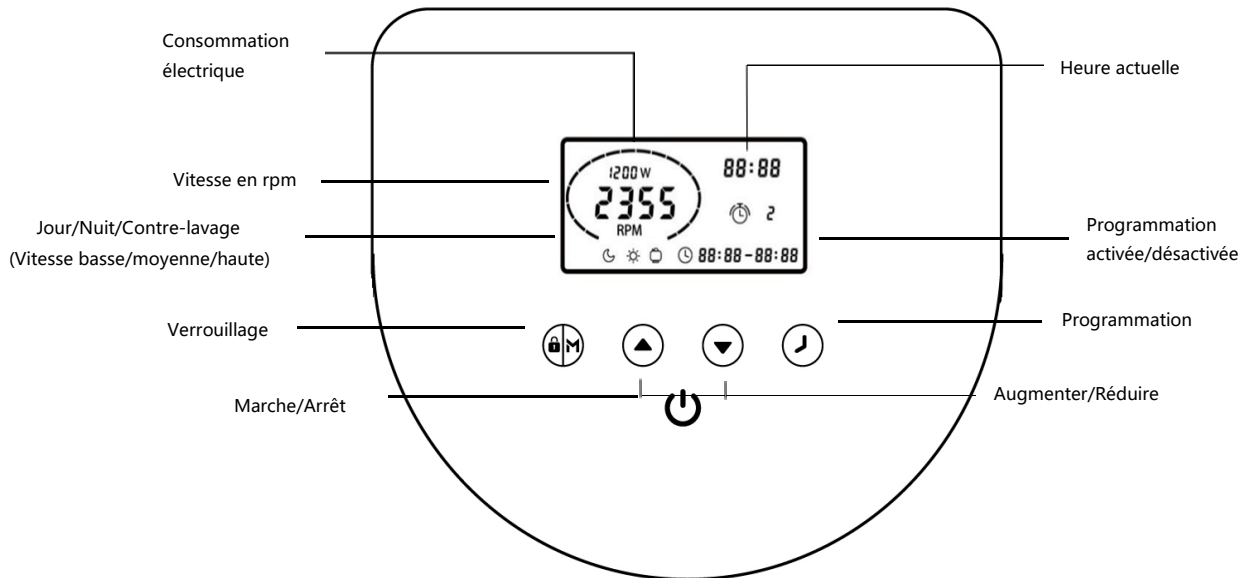

### 5.1 Panneau de commande





### 5.2 Sélection du mode

Le variateur de fréquence dispose de 3 modes (plages de vitesses). Vous pouvez faire fonctionner la pompe à une vitesse constante en sélectionnant « M » ou configurer 4 programmations quotidiennes avec une vitesse différente pour chacune.

Mode	Plage de vitesses	Vitesse par défaut
Nuit (Basse)	1200~1650 rpm	1400 rpm
Jour (Moyenne)	1700~2400 rpm	2000 rpm
Contre-lavage (Haute)	2450~2900 rpm	2900 rpm

① Lorsque l'appareil est branché,  s'allume. Appuyez sur  pendant 3 secondes pour déverrouiller l'écran. Appuyez sur  pour démarrer.

② Lors du démarrage, la pompe fonctionne à une vitesse maximale de 2900 rpm pendant une minute pour l'amorçage. (Vous pouvez augmenter le temps d'amorçage à 10 minutes. Pour ce faire, reportez-vous à la section 5.5 Réglage des paramètres.)

③ Appuyez sur  pour sélectionner une vitesse de fonctionnement. Utilisez les flèches  et  pour ajuster la vitesse à 50 rpm près si nécessaire.

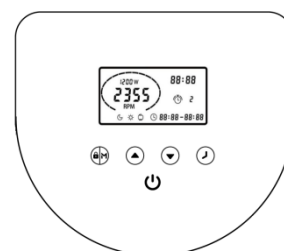





Une fois l'amorçage de la pompe terminé, l'appareil fait automatiquement fonctionner la pompe à la vitesse prédéfinie. L'écran  indique que la pompe est en fonctionnement et affiche la vitesse actuelle en rpm ainsi que la consommation électrique.

### 5.3 Réglage de la programmation

Pour faire fonctionner la pompe à différentes heures ou vitesses afin de profiter des tarifs d'électricité bas pendant la nuit, vous pouvez configurer jusqu'à 4 programmations.

Étape 1 : Appuyez sur  pour accéder au réglage de la programmation.

Étape 2 : À l'aide des flèches  et , définissez l'heure actuelle. Appuyez sur  pour accéder au paramètre suivant. Appuyez sur  pour sélectionner une plage

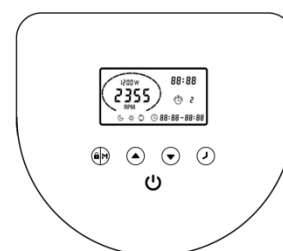

de vitesses pour la programmation 1 et utilisez les flèches ▲ et ▼ pour sélectionner une vitesse spécifique si nécessaire. Appuyez sur ▲ ▼ pour accéder au paramètre suivant.

Étape 3 : Répétez les étapes indiquées ci-dessus pour définir les 3 autres programmations.

Étape 4 : Appuyez sur ⏻ pendant 3 secondes ou patientez 10 secondes pour enregistrer les réglages automatiquement.

Lorsque 🕒 00:00 – 00:00 clignote, l'appareil est en attente de l'heure de démarrage.

Étape 5 : Appuyez sur ▲ ou ▼ pour consulter les 4 programmations et vérifier que tous les paramètres sont valides.

\* Si des plages horaires se chevauchent, les paramètres seront considérés comme non valides et le dispositif fonctionnera uniquement selon le réglage de programmation valide précédent.

\* Lors du réglage de la programmation, si vous voulez abandonner le réglage, appuyez sur 🚫 pendant 3 secondes.

Remarque :

\* Au bout d'une minute d'inactivité, l'écran se verrouille automatiquement.

Appuyez sur 🚫 pendant 3 secondes pour déverrouiller l'appareil.

\* L'appareil est équipé d'une mémoire hors tension. Le fonctionnement reprendra lorsque le courant sera rétabli.

\* En mode OFF, appuyez sur ▲ ⏻ pendant 3 secondes pour restaurer les paramètres d'usine.

## 5.4 Commande externe (facultatif)

Une commande externe peut être activée via les contacts suivants. Toutefois, même en cas de fonctionnement avec une commande externe, vous pouvez éteindre l'appareil en appuyant sur  $\cup$ .

N'alimentez pas en tension ces entrées.

BROCHE	Couleur du fil	Description du signal
1	ROUGE	Entrée numérique 4
2	NOIR	Entrée numérique 3
3	BLANC	Entrée numérique 2
4	GRIS	Entrée numérique 1
5	JAUNE	DGND
6	VERT	RS485-A
7	MARRON	RS485-B

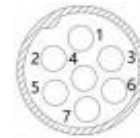

Fig. 8

Ex. : Pour activer la commande de la vitesse par entrée numérique, connectez l'une des broches PIN1/2/3 à COM.

Lorsque PIN4 est connecté à COM, la pompe s'arrête. En cas de déconnexion, la commande numérique ne sera pas valide.

Lorsque PIN3 est connecté à COM, la pompe fonctionne à 2900 rpm. En cas de déconnexion, la priorité de la commande revient au panneau de commande.

Lorsque PIN2 est connecté à COM, la pompe fonctionne à 2400 rpm. En cas de déconnexion, la priorité de la commande revient au panneau de commande.

Lorsque PIN1 est connecté à COM, la pompe fonctionne à 1200 rpm. En cas de déconnexion, la priorité de la commande revient au panneau de commande.

## 5.5 Réglage des paramètres

En mode OFF, appuyez sur ▲▼ pendant 3 secondes pour accéder au réglage des paramètres.

Paramètre	Description	Paramètre par défaut	Plage de valeurs
1	Temps d'amorçage	1 minute	0~10 min, par incréments de 1 minute
2	Rpm minimal	1200 rpm	1200~2000 rpm, par incréments de 100 rpm
3	PIN3	2900 rpm	1200~2000 rpm, par incréments de 100 rpm
4	PIN2	2400 rpm	1200~2000 rpm, par incréments de 100 rpm
5	PIN1	1200 rpm	1200~2000 rpm, par incréments de 100 rpm
6	Vitesse d'autoamorçage	2900 rpm	1200~2000 rpm, par incréments de 100 rpm

## 6. PROTECTION ET CODES D'ERREUR

Élément	Code	Description	Analyse
1	E001	Tension d'entrée anormale	Non défectueux.
2	E002	Surintensité au niveau de la sortie	Non défectueux.
3	E101	Surchauffe du dissipateur thermique	Contactez le fournisseur.
4	E102	Erreur de capteur de dissipateur thermique	Contactez le fournisseur.
5	E103	Erreur de carte mère de commande	Contactez le fournisseur.
6	E201	Erreur de carte de circuit imprimé	Contactez le fournisseur.
7	E202	Échec de lecture de l'EEPROM de la carte mère	Contactez le fournisseur.
8	E203	Erreur de lecture de l'heure de l'horloge temps réel	Contactez le fournisseur.
9	E204	Échec de lecture de l'EEPROM du clavier	Contactez le fournisseur.
10	E205	Erreur de communication	Contactez le fournisseur.
11	AL01	Réduction automatique de la vitesse en raison d'une température élevée	Contactez le fournisseur.

*Remarque :*

1. AL01 n'est pas un code d'erreur, il apparaît lorsque l'appareil réduit automatiquement la vitesse afin de protéger le système contre une température interne élevée. Lorsque la température redescend en dessous de 68 °C, l'appareil reprend le fonctionnement à la vitesse prédéfinie.

2. En cas d'erreur E002/E101/E103, l'appareil reprendra son fonctionnement automatiquement. Toutefois, si l'erreur survient pour la 4<sup>e</sup> fois, l'appareil cesse de fonctionner. Pour le remettre en marche, débranchez-le, rebranchez-le et redémarrez-le.



## 7. EXCLUSIONS

En aucun cas le fabricant ne sera tenu responsable des conséquences découlant d'une installation incorrecte ou inappropriée ou d'une non-compatibilité entre le produit et la pompe de piscine.

Le fabricant se réserve le droit de modifier les caractéristiques du produit ou ses performances ou le contenu du mode d'emploi sans préavis en cas de mise à niveau technique.

## 8. ÉLIMINATION



Ce symbole est requis par la directive 2012/19/UE de la Communauté européenne relative aux déchets d'équipements électriques et électroniques et indique que l'appareil ne doit pas être jeté dans une poubelle ordinaire. Il fera l'objet d'un tri sélectif afin d'être réutilisé, recyclé ou transformé. Toutes les substances qu'il contient pourraient être nuisibles à l'environnement et doivent être éliminées ou neutralisées. Demandez des informations sur les procédures de recyclage à votre détaillant.

AQUA  
**SPHERE**

# CONTROLADOR DEL INVERSOR AQUASPHERE

ES - MANUAL DE INSTRUCCIONES



INDICE

1. INSTRUCCIONES DE SEGURIDAD IMPORTANTES..... 34

2. DATOS TÉCNICOS ..... 37

3. ANTES DE LA INSTALACIÓN ..... 38

4. CONEXIÓN A LA BOMBA DE LA PISCINA ..... 38

5. CONFIGURACIÓN Y FUNCIONAMIENTO ..... 43

6. PROTECCIÓN Y CÓDIGOS DE ERROR ..... 47

7. NO INCLUYE ..... 48

8. ELIMINACIÓN ..... 48

SÍMBOLOS DE SEGURIDAD

	Lea este manual y guárdelo en un lugar seguro
	Advertencia
	Atención: peligro de descarga eléctrica
	No toque el dissipador térmico
	Residuo electrónico: entréguelo en un punto de reciclaje



## 2. INSTRUCCIONES DE SEGURIDAD IMPORTANTES



### INFORMACIÓN IMPORTANTE SOBRE SEGURIDAD, INSTALACIÓN Y MANTENIMIENTO

*Puede leer y descargar el manual completo en formato PDF en el sitio web [www.aquaspheremanuals.com](http://www.aquaspheremanuals.com)*



Para sacar todo el partido a este dispositivo que ahorra energía y evitar la posibilidad de provocar un incendio, descargas eléctricas, lesiones GRAVES a las personas o daños materiales, lea atentamente esta guía del usuario antes de realizar la instalación y consérvela por si necesita consultarla en el futuro.

- Todas las tareas de montaje, instalación eléctrica y mantenimiento deben ser realizadas por personal cualificado y autorizado que haya leído detenidamente las instrucciones de instalación y revisión.
- Este aparato no ha sido diseñado para que lo utilicen personas (incluidos niños) con capacidades físicas, sensoriales o mentales reducidas, o con falta de conocimiento y experiencia, a menos que estén bajo supervisión o hayan recibido instrucciones sobre el uso del aparato de una persona que se responsabilice de su seguridad.
- Los niños deben estar supervisados para que no jueguen con el aparato.
- Pueden utilizar este aparato los niños a partir de 8 años, personas con capacidad física, mental o sensorial reducida, así como personas con falta de experiencia o conocimientos, siempre que lo hagan bajo la supervisión de un adulto y que hayan recibido las instrucciones de seguridad necesarias relativas a su uso y comprendan los riesgos asociados.
- Los niños no deben jugar con el aparato.
- La limpieza y el mantenimiento del usuario no deben ser realizados por niños sin supervisión.
- Nuestro producto únicamente se puede montar e instalar en piscinas que cumplan con la norma IEC/HD 60364-7-702 y con la normativa nacional requerida. La instalación debe realizarse de conformidad con la norma IEC/HD 60364-7-702 y la normativa nacional requerida para piscinas.

Contacte con su distribuidor local para obtener más información.

- El controlador inversor no se puede instalar en las zonas 0 (Z0) o 1 (Z1). Puede ver diagramas en la página 2.
- Debe conectarse la unidad a una fuente de corriente alterna (véanse los datos en la placa del controlador inversor) con una toma de tierra, protegida por un dispositivo de corriente residual (RCD) que tenga una corriente operativa residual nominal inferior a 30 mA.
- Debe instalarse un seccionador en la instalación eléctrica fija que se ajuste a la normativa en materia de instalación.
- Solo se puede conectar UNA bomba al inversor. No conecte ningún otro aparato a la toma.

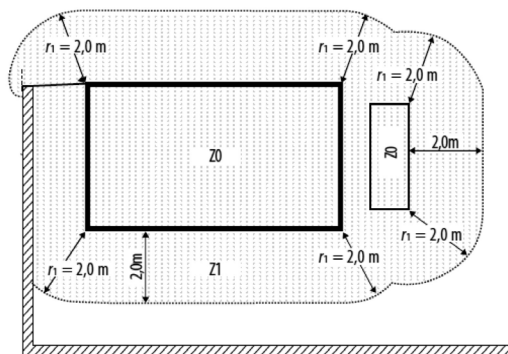
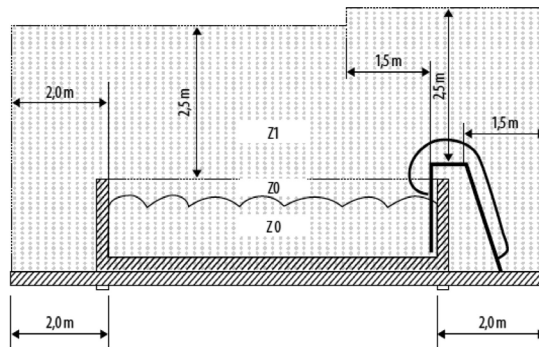
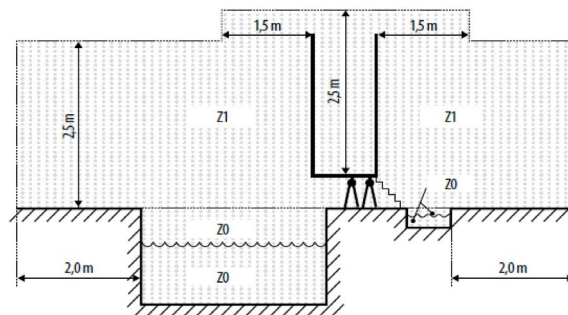



Este dispositivo ÚNICAMENTE puede ser utilizado con bombas de piscina que cuenten con un motor de condensador auxiliar permanente. El siguiente diagrama esquemático muestra el típico motor de bomba de piscina de velocidad única.

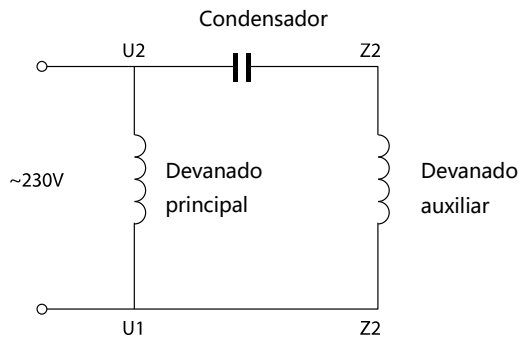

Fig. 1

1.1 NO es compatible con:

- a. Motores monofásicos (trifásicos) con interruptor centrífugo.
- b) Motores de bomba de piscina con relé o interruptor de encendido.
- c. Series o motores de CC.
- d. Motores de bomba de piscina con defectos en los rotores o condensadores.
- e. Motores asincrónicos de fase dividida.

1.2 Con este producto debe usarse un dispositivo de corriente residual (RCD) que tenga una corriente residual nominal inferior a 30 mA.



Si no está seguro de si su bomba de piscina es compatible con este dispositivo, consulte a su punto de venta o al fabricante antes de proceder con la instalación.

## 2. DATOS TÉCNICOS

### 2.1 Controlador inversor Aquasphere de 1,1 kW

Modelo	75947	Dimensiones
Potencia de entrada	Monofásico CA	
Tensión de entrada	220-240 V	
Frecuencia de entrada	50 Hz	
Potencia de salida	Máx. 1,1 kW	
Tensión de salida	Monofásica, 0-240 V	
Tipo de bomba	Monofásica	
Corriente máx.	Máx. 6 A	
Gama de velocidades	1200~2900 rpm	
Refrigeración	Ventilación	
Dimensiones netas (L×An×Al)	222×117×166 mm	

### 3. ANTES DE LA INSTALACIÓN



Tras recibir este dispositivo, compruebe que ni el embalaje ni el producto hayan resultado dañados.

NO PROCEDA con la instalación si detecta algún daño; póngase en contacto con el punto de venta.

No use alargadores con el dispositivo. Pueden suponer un peligro, en especial cerca de una piscina.

Asegúrese de que el lugar elegido para la instalación cumpla las siguientes condiciones:

- Temperatura ambiente de  $-10\sim 40\text{ }^{\circ}\text{C}$
- Humedad relativa de entre el 45 y el 90 %, sin condensación
- Menos de 1000 m por encima del nivel del mar
- Evitando que le dé la luz directa del sol
- Buena ventilación

Para que tenga una buena refrigeración, compruebe que se instale dejando un espacio mínimo libre a su alrededor (fig. 2).

Si se bloquea la ventilación o se elige un lugar cerrado con un flujo de aire limitado, se podría provocar un recalentamiento o un posible fallo operativo del inversor.

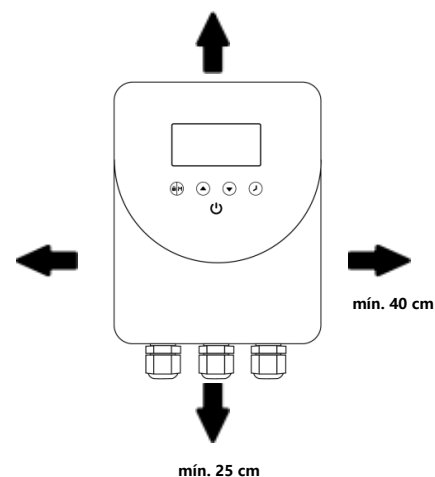

Fig. 2

### 4. CONEXIÓN A LA BOMBA DE LA PISCINA



Siga los siguientes pasos y el esquema de conexiones para conseguir una conexión correcta. Podría invalidar la garantía si el dispositivo no se instala de conformidad con las instrucciones descritas en este manual.

Solo se puede conectar UNA bomba al inversor. Por favor, no conecte ningún otro aparato a la toma.



Marque la ubicación de los agujeros en la pared, hágalos e inserte los topes de expansión suministrados, coloque los tornillos y cuelgue el dispositivo de estos.

4.1 Corte la corriente eléctrica a la bomba de piscina desenchúfela de la toma principal o del equipo de electrólisis que alimente de electricidad la bomba.

4.2 Conecte la bomba de piscina a la salida de potencia del dispositivo (con la marca SOLO CONEXIÓN DE BOMBA).

Es recomendable que la longitud total del cable de salida del equipo y del cable de la bomba de piscina no supere los 2 m.

4.3 Conecte el dispositivo a la corriente principal/el equipo de electrólisis/el temporizador al que estuviese conectada inicialmente la bomba.

4.4 Para reducir el impacto de la interferencia electromagnética, conecte la toma de tierra, que está fijada al disipador térmico, al motor de la bomba de piscina (si la salida del inversor de frecuencia no cuenta con una toma, no es necesario conectarla).

4.5 Vuelva a activar la corriente.

4.6 Compruebe que el equipo de electrólisis/temporizador esté activo.

4.7 Ahora el dispositivo está listo para ser utilizado.

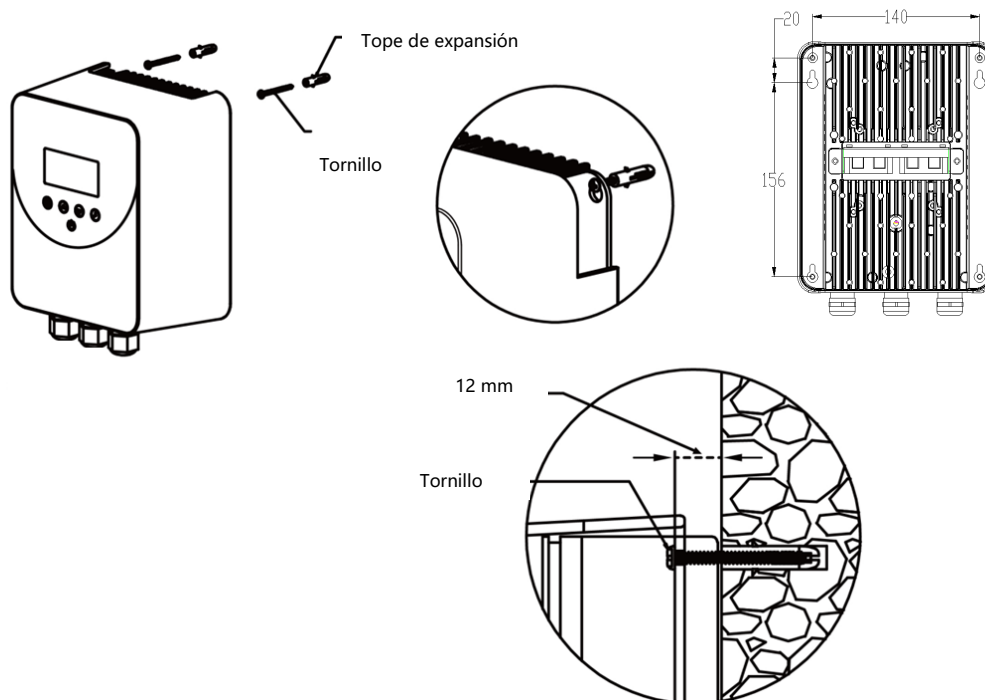

Fig. 3

La figura superior sirve solo de referencia; la toma y el enchufe pueden variar en función de los distintos países/regiones.

Si el enchufe de la bomba ya está incluido en el dispositivo, conecte el dispositivo tal y como se indica en las fig. 4 y 5.

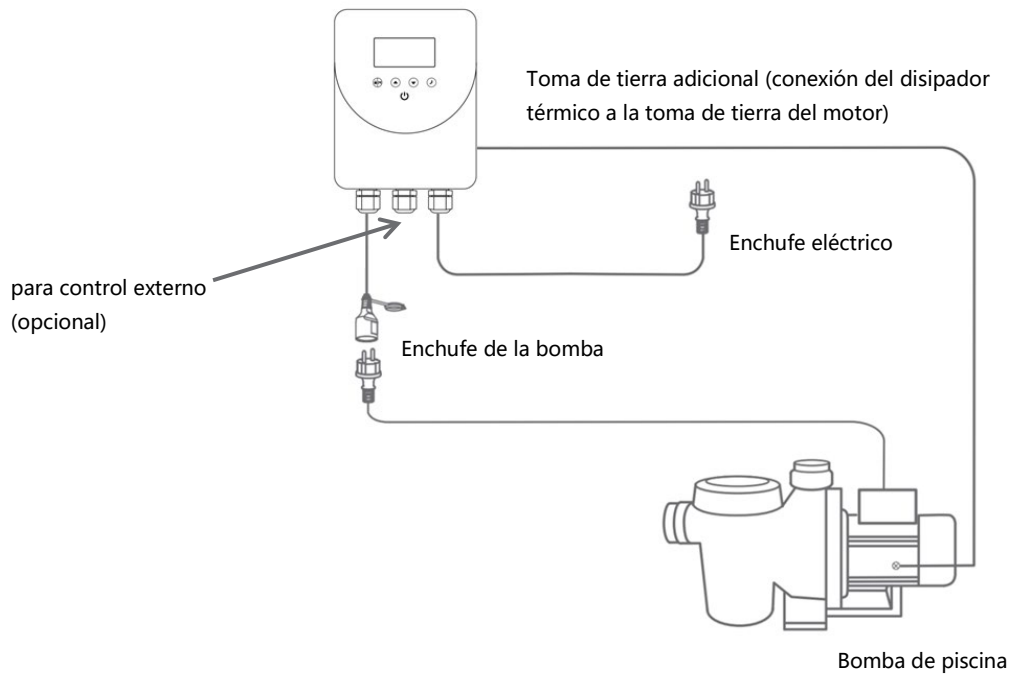

Fig. 4

La figura superior sirve solo de referencia; la toma y el enchufe pueden variar en función de los distintos países/regiones.

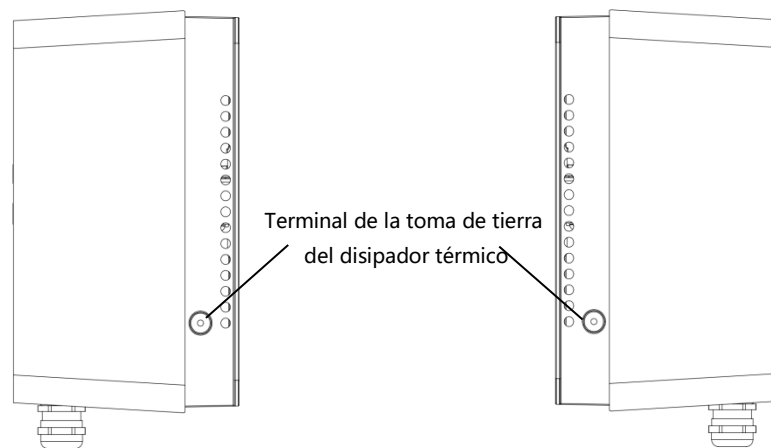

Fig. 5 Diagrama del terminal de la toma de tierra

Si el enchufe de la bomba no está incluido en el dispositivo, conecte el dispositivo tal y como se indica en las fig. 6 y 7.

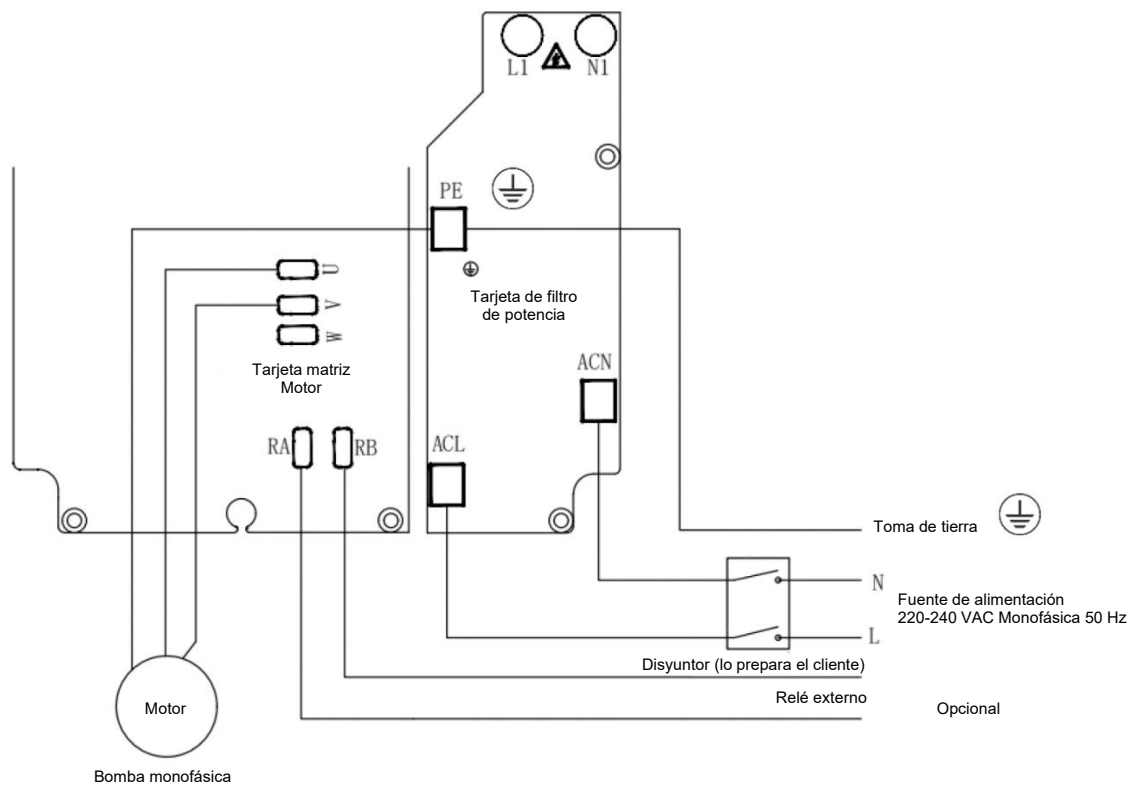
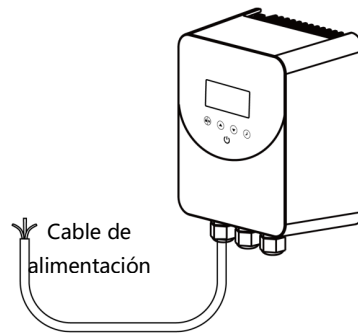

Fig. 6 Diagrama de conexión de bomba monofásica

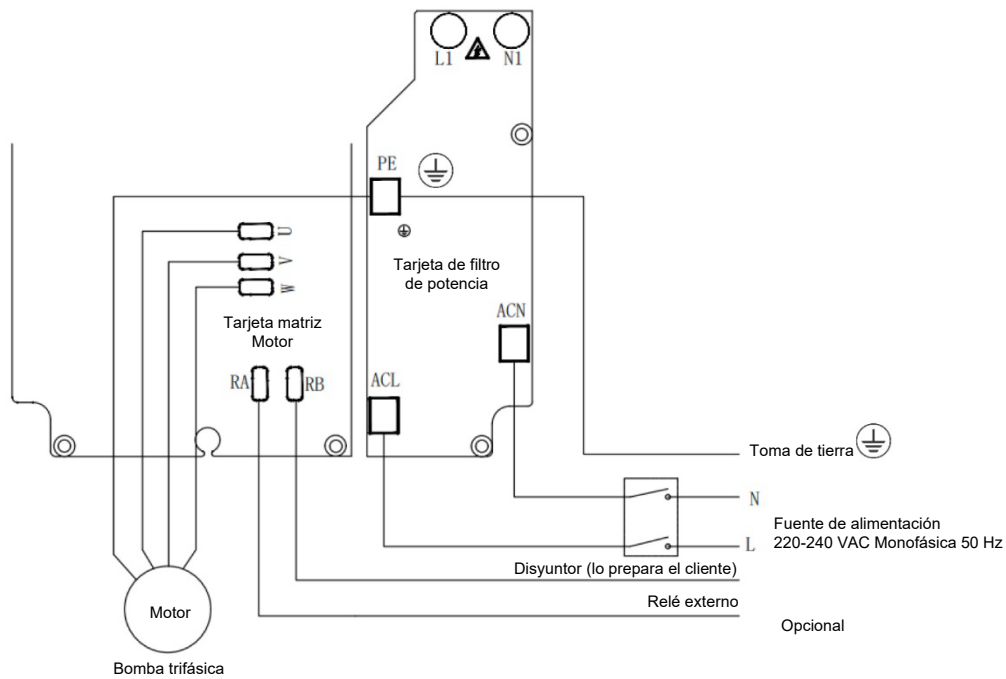

Fig. 7 Diagrama de conexión de bomba trifásica



No toque el disipador térmico mientras el dispositivo esté en funcionamiento o hasta que hayan transcurrido al menos 30 minutos desde que se haya apagado. Manténgalo fuera del alcance de los niños.



Debido a los componentes de conversión de alta tensión que contiene el dispositivo, no intente desmontar ni cambiar ningún elemento en caso de funcionamiento incorrecto o avería. Antes de revisar la unidad, espere a que la luz de encendido se apague o al menos 3 minutos desde que se haya desconectado el enchufe de la corriente.



Si se trata de un controlador inversor trifásico, conecte el motor de la bomba con la conexión en triángulo.

## 5. CONFIGURACIÓN Y FUNCIONAMIENTO

### 5.1 Panel de control

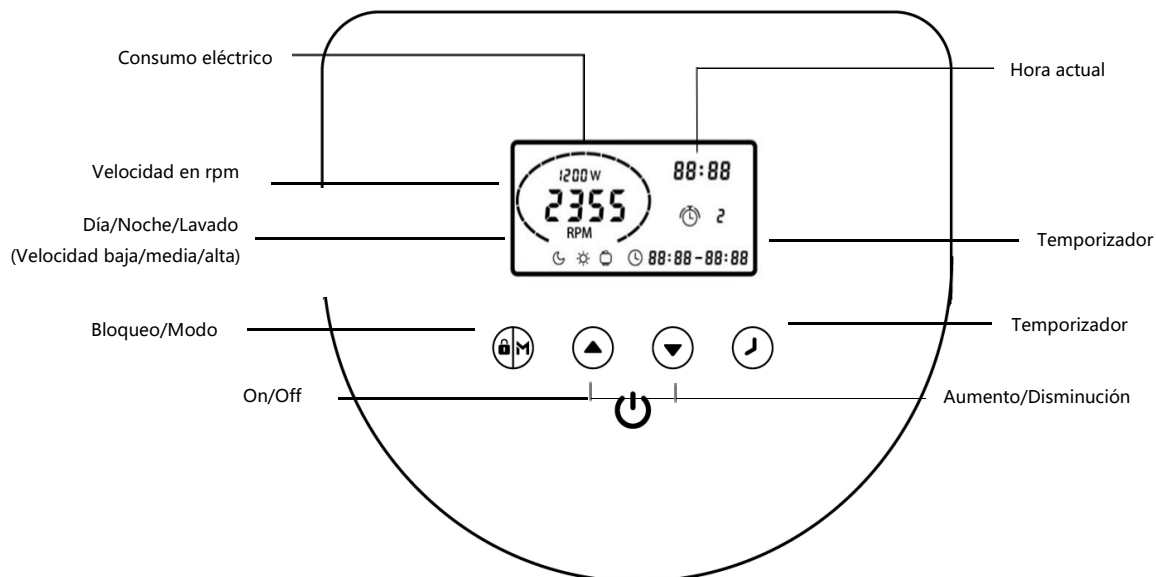







### 5.2 Selección de modo

El inversor de frecuencia cuenta con 3 modos (gamas de velocidades).

Puede elegir entre que la bomba funcione a una velocidad constante eligiendo en «M» o configurar 4 temporizadores para el funcionamiento cotidiano, cada uno de ellos con una velocidad individual.

Modo	Gama de velocidades	Velocidad por defecto
Noche (baja)	1200~1650 rpm	1400 rpm
Día (media)	1700~2400 rpm	2000 rpm
Lavado (alta)	2450~2900 rpm	2900 rpm

- ① Al enchufarlo,  se enciende; mantenga pulsado  durante 3 segundos para desbloquear la pantalla. Pulse  para encenderlo.
- ② Al ponerla en marcha, la bomba funcionará a la velocidad máxima de 2900 rpm para realizar un autocebado de un minuto (se puede subir a 10 minutos; véase el apartado 5.5 «Configuración de parámetros»).
- ③ Pulse  para elegir una velocidad de funcionamiento; use las flechas  o  para ajustar en saltos de 50 rpm a una velocidad de funcionamiento específica, si fuese necesario.

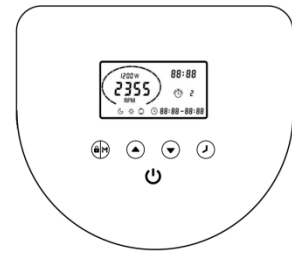

Una vez que la bomba haya finalizado el cebado, el inversor pondrá automáticamente la bomba en la velocidad preestablecida;  indica que la bomba está en funcionamiento y muestra las rpm y el consumo de energía actuales.

### 5.3 Configuración del temporizador



Para que la bomba funcione a distintas horas o velocidades y aprovechar las tarifas eléctricas más baratas durante la noche, puede configurar hasta 4 temporizadores.

Paso 1 : pulse  para acceder a la configuración de los temporizadores.

Paso 2 : use  o  para configurar la hora actual.

Pulse  para desplazar el cursor al siguiente campo.

Pulse  para elegir una gama de velocidades para el

temporizador 1; use  o  para decidir una velocidad específica,

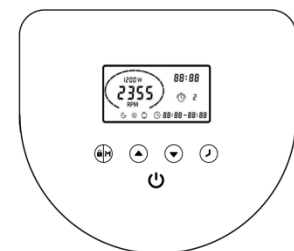

si fuese necesario. Pulse   para desplazar el cursor al campo anterior.



Paso 3 : repita los pasos anteriores para configurar los otros 3 temporizadores.

Paso 4 : mantenga pulsado  durante 3 segundos o espere 10 segundos para que la configuración se guarde automáticamente.

Un  **88:88 – 88:88** parpadeante indica que el dispositivo está esperando a que llegue la hora de inicio.

Paso 5 : pulse  o  para revisar los 4 temporizadores y asegurarse de que no haya ningún parámetro incorrecto.



\* La superposición de los horarios de los temporizadores será considerada inválida y el dispositivo únicamente funcionará tomando en consideración la configuración válida previa.

\* Durante la configuración de los temporizadores, si desea salir, mantenga pulsados  durante 3 segundos.

Nota:

\* Si está inactiva durante 1 minuto, la pantalla se bloqueará automáticamente. Mantenga pulsado  durante 3 segundos para desbloquear el dispositivo.

\* El dispositivo cuenta con memoria de apagado y reiniciará el funcionamiento cuando vuelva la corriente.

\* Cuando esté en modo OFF, mantenga pulsados   durante 3 segundos para volver a los valores de fábrica.

## 5.4 Control externo (opcional)

El control externo se puede activar mediante los siguientes contactos. Sin embargo, incluso si funcionase a través de un controlador externo, al pulsar podrá detener el dispositivo.

No aplique tensión a estas entradas.

PIN	Color del cable	Descripción de la señal
1	ROJO	Entrada digital 4
2	NEGRO	Entrada digital 3
3	BLANCO	Entrada digital 2
4	GRIS	Entrada digital 1
5	AMARILLO	DGND
6	VERDE	RS485-A
7	MARRÓN	RS485-B

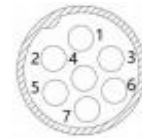

Fig. 8

P. ej.: para permitir el control externo de la velocidad a través de una entrada digital, conecte uno de los dígitos de los PIN 1/2/3 a COM.



Cuando se conecte el PIN4 a COM, la bomba se detendrá; si está desconectada, el control digital será inválido.

Cuando se conecte el PIN3 a COM, la bomba funcionará a 2900 rpm; si está desconectada, la prioridad de control volverá al panel.

Cuando se conecte el PIN2 a COM, la bomba funcionará a 2400 rpm; si está desconectada, la prioridad de control volverá al panel.

Cuando se conecte el PIN1 a COM, la bomba funcionará a 1200 rpm; si está desconectada, la prioridad de control volverá al panel.

## 5.5 Configuración de parámetros

Cuando esté en modo OFF, mantenga pulsados   durante 3 segundos para acceder a la configuración de parámetros.



Parámetro	Descripción	Configuración por defecto	Rango determinado
1	Hora de cebado	1 minuto	0~10 min, en incrementos de 1 minuto
2	rpm mínimas	1200 rpm	1200~2000 rpm, en incrementos de 100 rpm
3	PIN3	2900 rpm	1200~2900 rpm, en incrementos de 100 rpm
4	PIN2	2400 rpm	1200~2900 rpm, en incrementos de 100 rpm
5	PIN1	1200 rpm	1200~2900 rpm, en incrementos de 100 rpm
6	Velocidad de autocebado	2900 rpm	1200~2900 rpm, en incrementos de 100 rpm

## 6. PROTECCIÓN Y CÓDIGOS DE ERROR

Elemento	Código	Descripción	Análisis
1	E001	Tensión de entrada anómala	No está averiado
2	E002	Sobrecorriente de salida	No está averiado
3	E101	Sobrecalentamiento del disipador térmico	Consulte a su suministrador
4	E102	Error del sensor del disipador térmico	Consulte a su suministrador
5	E103	Error de la tarjeta maestra de controladores	Consulte a su suministrador
6	E201	Error de la tarjeta de circuitos	Consulte a su suministrador
7	E202	Fallo de lectura de EEPROM de la tarjeta maestra	Consulte a su suministrador
8	E203	Error de lectura de la hora RTC	Consulte a su suministrador
9	E204	Fallo de lectura de EEPROM del teclado	Consulte a su suministrador
10	E205	Error de comunicación	Consulte a su suministrador
11	AL01	Reducción automática de la velocidad para contrarrestar la temperatura elevada	Consulte a su suministrador

### Notas:

1. AL01 no es una indicación de error: cuando aparece, el inversor pasará automáticamente a una velocidad más baja para protegerse de una temperatura interna elevada. Cuando la temperatura vuelva a los 68 °C, el inversor retomará la velocidad preestablecida.

2. Cuando se resuelvan las causas E002/E101/E103, el dispositivo se volverá a poner en funcionamiento automáticamente; sin embargo, cuando aparezcan por cuarta vez, el dispositivo dejará de funcionar y, para volver a hacerlo, tendrá que desenchufar el dispositivo, reconectarlo y volver a encenderlo.

## 7. NO INCLUYE

En ningún caso se podrá considerar responsable al fabricante por cualquier consecuencia que resulte de una instalación incorrecta o de la conexión inadecuada del producto a bombas de piscina que no sean compatibles.

El fabricante se reserva el derecho a cambiar la especificación del producto, su rendimiento o el contenido de la guía del usuario sin aviso previo en caso de que se trate de una actualización técnica.

## 8. ELIMINACIÓN



Este símbolo es exigido por la Directiva 2012/19/UE de la Comunidad Europea sobre RAEE (residuos de aparatos eléctricos y electrónicos) y significa que no debe tirar su aparato al contenedor de la basura. Deberá ser recogido en un punto limpio para que pueda ser reutilizado, reciclado o transformado. Cualquier sustancia que pueda contener y sea potencialmente peligrosa para el medio ambiente deberá ser eliminada o neutralizada. Pida información sobre los procesos de reciclaje en su punto de venta.



# UNITÀ DI CONTROLLO PER INVERTER AQUASPHERE

IT - MANUALE D'USO



INDICE

1. ISTRUZIONI IMPORTANTI RELATIVE ALLA SICUREZZA ..... 51

2. SPECIFICHE TECNICHE ..... 54

3. PRIMA DELL' INSTALLAZIONE ..... 55

4. COLLEGAMENTO ALLA POMPA DELLA PISCINA ..... 55





5. IMPOSTAZIONI E FUNZIONAMENTO ..... 60

6. PROTEZIONE E CODICI DI ERRORE ..... 64

7. ESCLUSIONI DI RESPONSABILITÀ ..... 65

8. SMALTIMENTO ..... 65

SIMBOLI DI SICUREZZA

	Leggere e conservare il manuale in un luogo sicuro
	Pericolo
	Attenzione: rischio di scosse elettriche
	Non toccare il dissipatore di calore
	Rifiuti elettronici: smaltire presso un centro di riciclaggio



## 5. ISTRUZIONI IMPORTANTI RELATIVE ALLA SICUREZZA



### INFORMAZIONI IMPORTANTI IN MERITO A SICUREZZA, INSTALLAZIONE E MANUTENZIONE

È possibile consultare e scaricare in formato PDF la versione integrale del manuale dal sito Web [www.aquaspheremanuals.com](http://www.aquaspheremanuals.com).



Per utilizzare al meglio questo dispositivo a risparmio energetico ed evitare potenziali rischi di incendio, scosse elettriche, GRAVI lesioni o danni materiali, leggere attentamente il presente manuale d'uso prima dell'installazione e conservarlo per future consultazioni.

- Affidare tutti gli interventi di montaggio, installazione elettrica e manutenzione a personale qualificato e autorizzato che abbia letto attentamente le istruzioni di installazione e manutenzione.
- L'apparecchio non è destinato all'uso da parte di persone (bambini inclusi) con ridotte capacità fisiche, sensoriali o mentali, o con mancanza di esperienza e conoscenza, a meno che non siano supervisionate o istruite in merito all'uso dell'apparecchio da una persona responsabile della loro sicurezza.
- Sorvegliare i bambini per evitare che giochino con l'apparecchio.
- Questo apparecchio può essere utilizzato da bambini a partire dagli 8 anni di età e da persone con ridotte capacità fisiche, sensoriali o mentali o con scarsa esperienza e conoscenza, a condizione che siano supervisionate o abbiano ricevuto istruzioni in merito all'uso dell'apparecchio in sicurezza e che comprendano i rischi connessi.
- I bambini non devono giocare con l'apparecchio.
- I bambini non possono eseguire interventi di pulizia o manutenzione senza la supervisione di un adulto.
- L'apparecchio può essere montato e installato solamente in piscine conformi agli standard IEC/HD 60364-7-702 e alle norme nazionali richieste. L'installazione deve essere conforme allo standard IEC/HD 60364-7-702 e alle norme nazionali vigenti per le piscine.

Per ulteriori informazioni, consultare il rivenditore locale.

- È vietato installare l'unità di controllo per inverter nella Zona 0 (Z0) o nella Zona 1 (Z1). Consultare gli schemi a pagina 2.

- Collegare l'apparecchio a una sorgente di alimentazione a corrente alternata (vedi i dati sulla targhetta dell' unità di controllo per inverter) con un collegamento a terra, protetto da un interruttore differenziale (RCD) con una corrente nominale di esercizio residua non superiore a 30 mA.

- Dotare l'impianto elettrico fisso di un sezionatore in conformità alle norme di installazione.

- All'inverter può essere collegata UNA sola pompa. Non collegare altri apparecchi all' uscita.

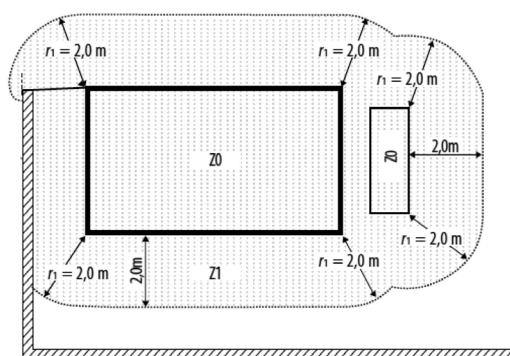
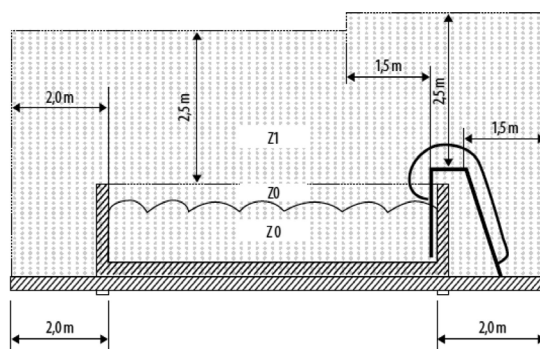
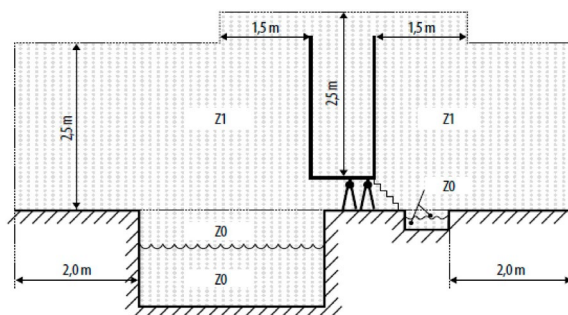



Questo dispositivo può essere utilizzato SOLO con pompe per piscine provviste di motore con condensatore di avviamento e marcia. Lo schema sottostante raffigura un tipico motore di pompa per piscina a velocità singola.

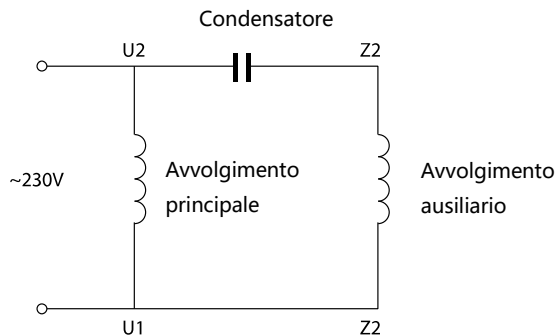

Fig. 1

1.1 NON è compatibile con:

- a. Motori monofase (trifase) con interruttore centrifugo.
- b. Motori di pompe per piscine con relè o interruttore di avviamento.
- c. Motori in serie o in corrente continua.
- d. Motori di pompe per piscine con guasti ai rotori o ai condensatori.
- e. Motori asincroni a poli schermati.

1.2 Con questo prodotto è necessario utilizzare un interruttore differenziale con corrente residua nominale non superiore a 30 mA.



Se non si è sicuri della compatibilità della propria pompa per piscine con questo dispositivo, contattare il fornitore o il produttore prima di procedere all'installazione.

## 2. SPECIFICHE TECNICHE

### 2.1 Unità di controllo per inverter Aquasphere da 1,1 kW

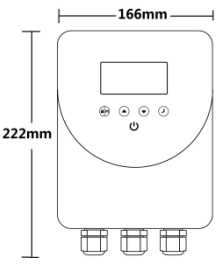
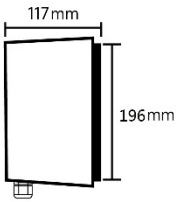
Modello	75947	Dimensioni
Potenza d' ingresso	AC monofase	
Tensione di ingresso	220-240 V	
Frequenza di ingresso	50 Hz	
Potenza di uscita	Max 1,1 kW	
Tensione di uscita	Monofase, 0-240 V	
Tipo di pompa	Monofase	
Corrente massima	Max 6A	
Intervallo di velocità	1200~2900 giri/min	
Raffreddamento	Ventilazione	
Dimensioni nette (lung*alt*larg)	222*117*166 mm	



### 3. PRIMA DELL' INSTALLAZIONE



Al momento della consegna del dispositivo, verificare l'assenza di danni all'imballaggio o al prodotto.

Qualora si riscontrassero dei danni, **NON PROCEDERE** all'installazione, ma contattare il fornitore.

Non utilizzare prolunghe con il dispositivo, che potrebbero rappresentare un pericolo soprattutto in prossimità di una piscina.

Assicurarsi che il luogo scelto per l'installazione soddisfi le seguenti condizioni:

- Temperatura ambiente da -10~40°C
- Umidità relativa dal 45% al 90%, senza condensa
- Altitudine inferiore a 1000 m sul livello del mare
- Lontano dalla luce diretta del sole
- Buona ventilazione

Per un raffreddamento efficiente, assicurarsi di avere installato il dispositivo lasciando uno spazio minimo intorno (Fig. 2).

Qualsiasi ostruzione alla ventilazione o uno spazio chiuso con un flusso d'aria limitato possono causare un surriscaldamento o un potenziale malfunzionamento dell'inverter.

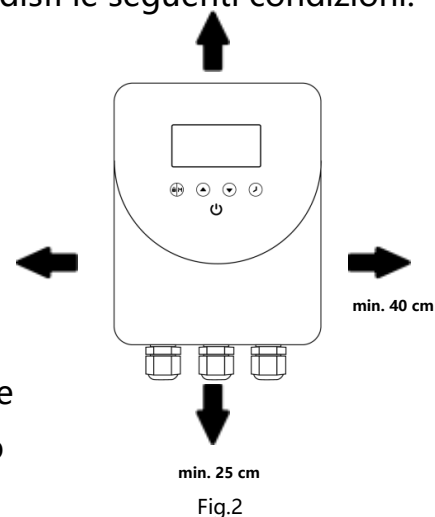

### 4. COLLEGAMENTO ALLA POMPA DELLA PISCINA



Per un collegamento corretto, attenersi alla seguente procedura e allo schema di cablaggio. La garanzia potrebbe non coprire i danni, se il dispositivo non viene installato secondo le istruzioni riportate in questo manuale.

All'inverter può essere collegata UNA sola pompa. Non collegare altri apparecchi all'uscita.

Segnare le posizioni dei fori sulla parete, forare e inserire i tasselli a espansione in dotazione, montare le viti e appendervi il dispositivo.

4.1 Interrompere l'alimentazione elettrica della pompa della piscina, staccando la spina dall'interruttore principale o dal clorinatore che fornisce l'alimentazione elettrica alla pompa.

4.2 Collegare la pompa della piscina alla presa di corrente del dispositivo (contrassegnata con SOLO COLLEGAMENTO POMPA).

È sconsigliabile che la lunghezza complessiva della linea di uscita dell'apparecchio e della linea di alimentazione della pompa superi i 2 m.

4.3 Collegare il dispositivo al connettore dell'interruttore principale/clorinatore/timer a cui la pompa era originariamente collegata.

4.4 Al fine di ridurre l'impatto delle interferenze elettromagnetiche collegare il filo di messa a terra, fissato sul dissipatore di calore, al motore della pompa della piscina (se l'uscita del convertitore di frequenza non ha una spina, non è necessario collegarla).

4.5 Riaccendere l'alimentazione.

4.6 Verificare che il clorinatore/timer sia attivo.

4.7 Ora il dispositivo è pronto per funzionare.

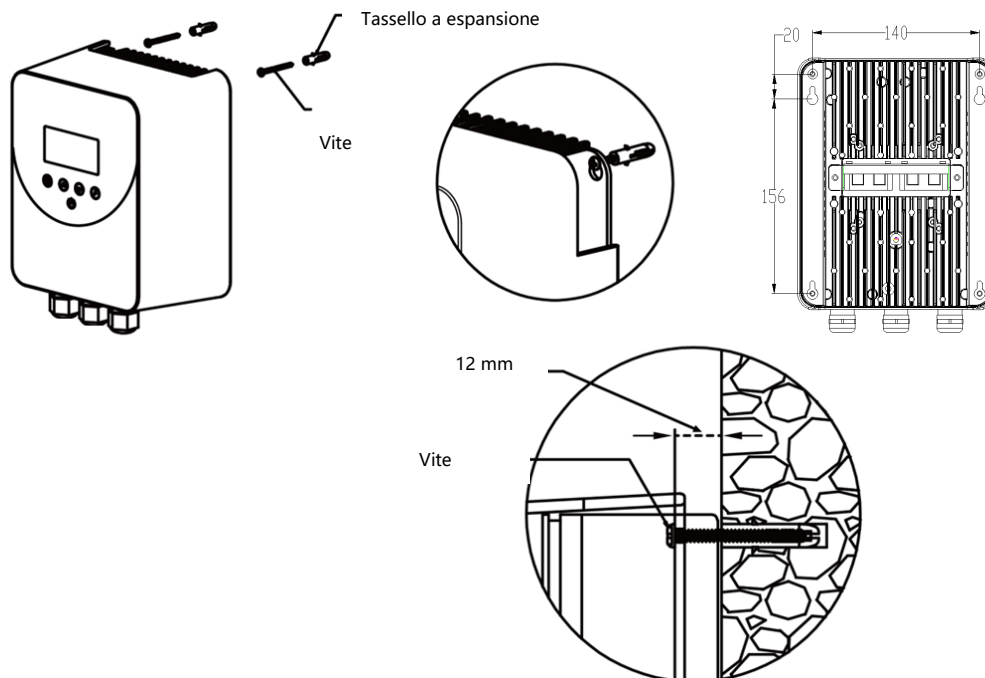

Fig. 3

La figura ha una mera funzione di riferimento, le spine e le prese possono variare a seconda dei Paesi/regioni.

Se la presa della pompa è già inclusa nel dispositivo, procedere al rispettivo cablaggio come illustrato nelle Fig. 4 e 5.

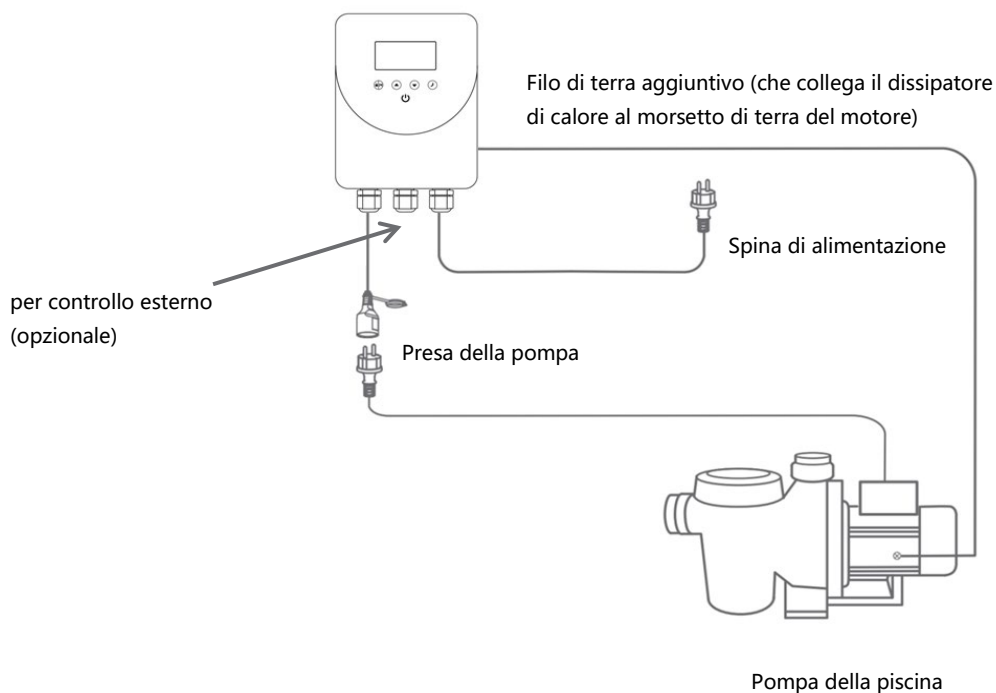

Fig. 4

La figura ha una mera funzione di riferimento, le spine e le prese possono variare a seconda dei Paesi/regioni.

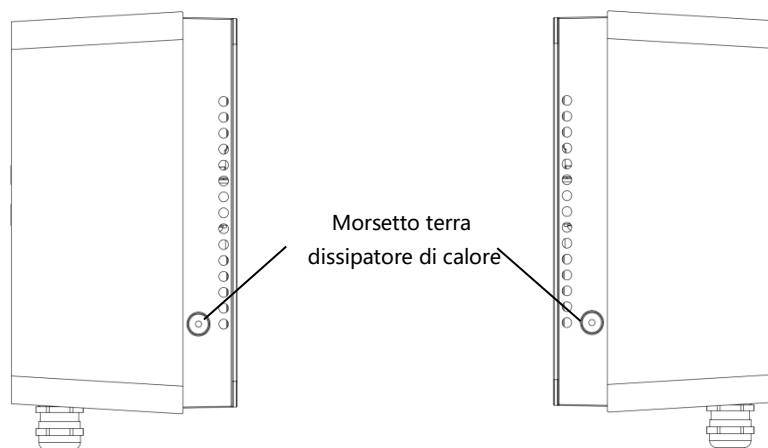

Fig. 5 Schema dei morsetti del filo di terra

Qualora la presa della pompa non fosse già inclusa nel dispositivo, procedere al rispettivo cablaggio come illustrato nelle Fig. 6 e 7.

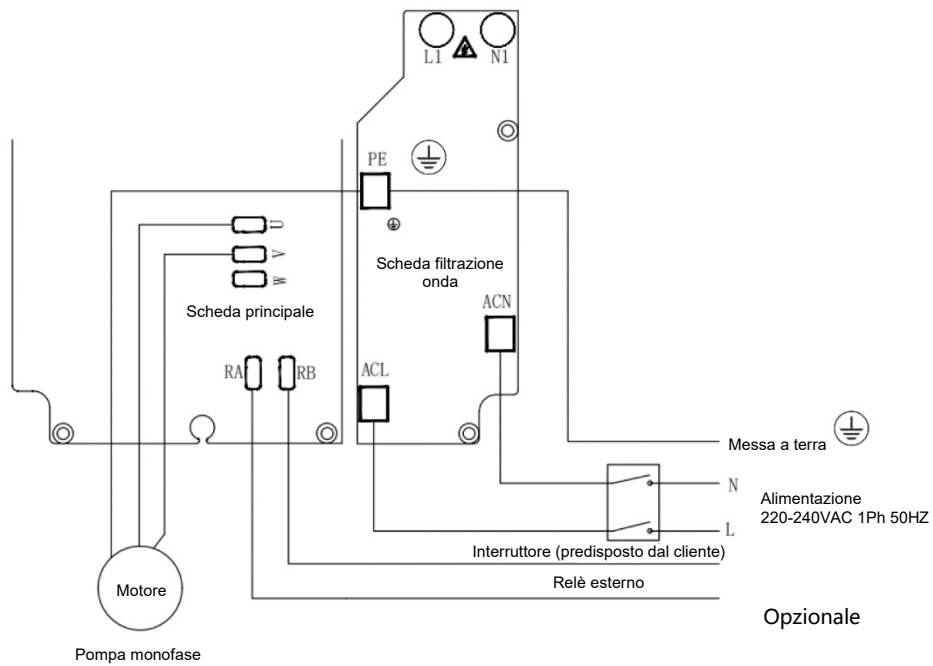
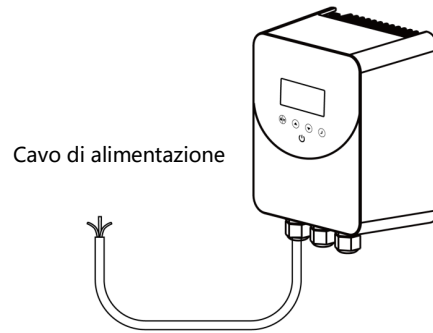
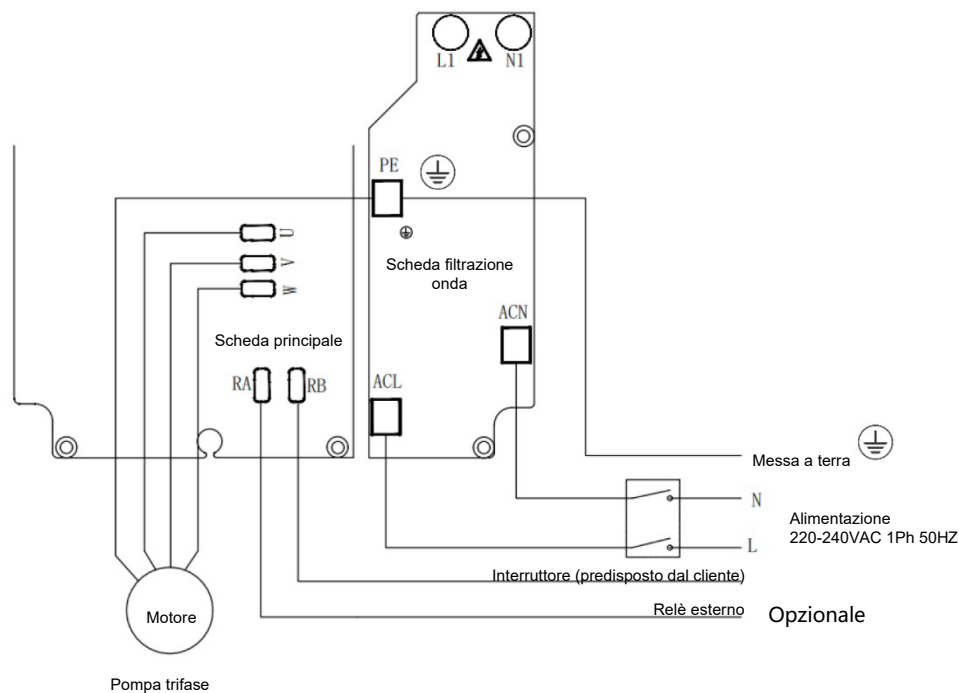

Fig. 6 Schema di collegamento della pompa monofase



Non toccare il dissipatore di calore mentre il dispositivo è in funzione o quantomeno attendere 30 minuti dopo lo spegnimento. Tenere fuori dalla portata dei bambini.



A causa dei componenti di conversione ad alta tensione contenuti nel dispositivo, non cercare di smontare né sostituire alcun componente in caso di malfunzionamento o guasto. Prima di mettere in funzione il dispositivo, attendere che la spia di alimentazione si spenga o aspettare almeno 3 minuti dallo scollegamento della spina dall' alimentazione di ingresso.



Per l'unità di controllo inverter trifase, collegare il motore della pompa con un collegamento a triangolo.

## 5. IMPOSTAZIONI E FUNZIONAMENTO



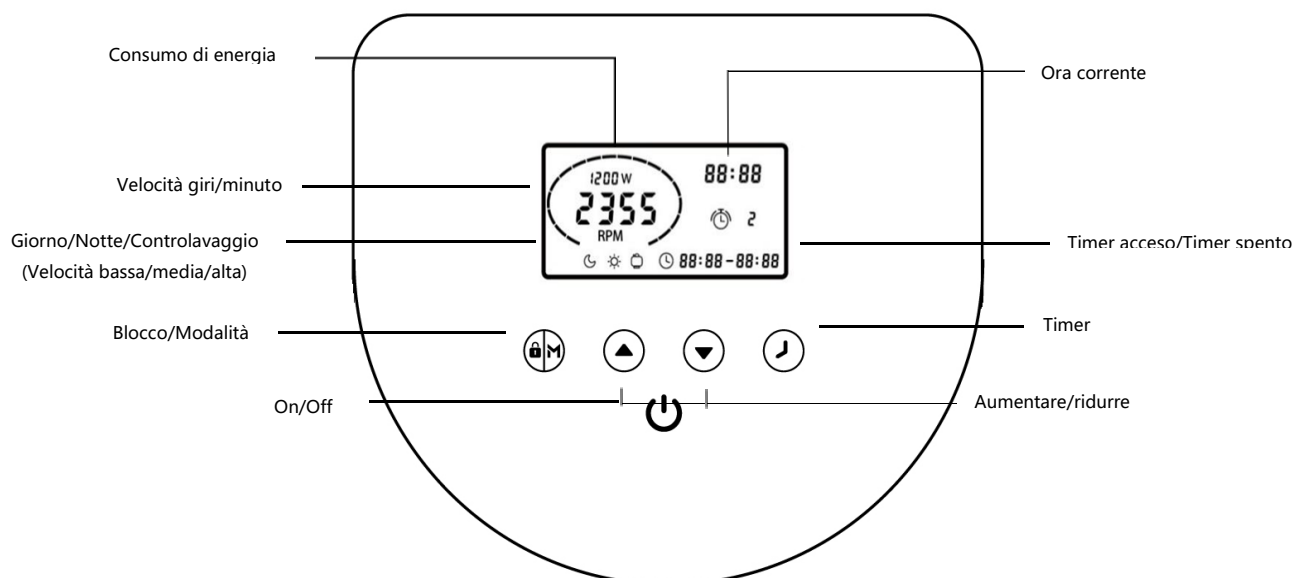

### 5.1 Pannello di controllo



### 5.2 Selezione della modalità

Il convertitore di frequenza prevede 3 modalità (intervalli di velocità). È possibile far funzionare la pompa a velocità costante premendo "M" o impostare fino a 4 timer per il funzionamento giornaliero, ciascuno con una velocità individuale.

Modalità	Intervallo di velocità	Velocità predefinita
Notte (bassa)	1200~1650 giri/min	1400 giri/min
Giorno (media)	1700~2400 giri/min	2000 giri/min
Controlavaggio (alta)	2450~2900 giri/min	2900 giri/min

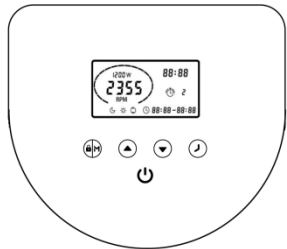
<p>① Quando il dispositivo è collegato, il tasto  si accende, tenerlo premuto per 3 secondi per sbloccare lo schermo. Premere  per iniziare.</p> <p>② All'avvio, la pompa funziona alla velocità massima di 2900 giri/min per un minuto di autoadescamento (è possibile aumentarlo a 10 minuti; a tal proposito, consultare il punto 5.5 Impostazione dei parametri).</p> <p>③ Premere  per scegliere la velocità di marcia, usare le frecce  o  per regolare di 50 giri al minuto una velocità di marcia specifica, se necessario.</p>	
--	---







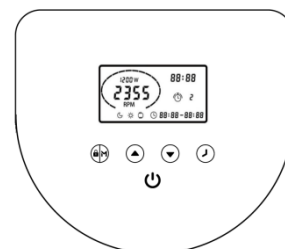

Al termine dell'adescamento della pompa, l'inverter farà automaticamente in modo che la pompa funzioni alla velocità prestabilita.  che la pompa è in funzione e mostra il numero di giri e il consumo di energia attuali.

### 5.3 Impostazione del timer

Per far funzionare la pompa a orari o velocità diverse, in modo da sfruttare le tariffe elettriche più convenienti di notte, è possibile impostare fino a 4 timer.





Fase 1 : Premere  per accedere all'impostazione del timer.

Fase 2 : Premere  o  per impostare l'ora corrente. Premere  per spostare il cursore sull'impostazione successiva. Premere  per scegliere un intervallo di velocità per il timer 1, quindi premere  o  per impostare una velocità specifica, se necessario. Premere   per spostare il cursore sull'impostazione precedente.

Fase 3 : Ripetere i passaggi precedenti per impostare gli altri 3 timer.

Fase 4 : Tenere premuto  per 3 secondi o attendere 10 secondi per salvare automaticamente le impostazioni.



Se appare il messaggio lampeggiante  **88:88 - 88:88** significa che il dispositivo è in attesa dell'ora di avvio.

Fase 5 : Premere  o  per controllare tutti e 4 i timer e verificare che non vi siano impostazioni non valide.

\* Qualsiasi sovrapposizione dei periodi dei timer sarà considerata non valida e il dispositivo funzionerà solo in base alla precedente impostazione valida del timer.

\* Durante l'impostazione del timer, se si desidera uscire, tenere premuto  per 3 secondi.

Nota:

- \* Se lo schermo rimane inattivo per 1 minuto, si blocca automaticamente. Tenere premuto  per 3 secondi per sbloccare il dispositivo.
- \* Il dispositivo è dotato di memoria di spegnimento; il funzionamento riprenderà al ripristino dell'alimentazione.
- \* In modalità OFF, tenere premuto   per 3 secondi per recuperare le impostazioni di fabbrica.



## 5.4 Controllo esterno (opzionale)

Il controllo esterno può essere attivato tramite i seguenti contatti. Tuttavia, anche se funziona tramite un' unità di controllo esterna, premendo  è possibile arrestare il dispositivo.

Non applicare tensione a tali ingressi.

PIN	Colore del filo	Descrizione del segnale
1	ROSSO	Ingresso digitale 4
2	NERO	Ingresso digitale 3
3	BIANCO	Ingresso digitale 2
4	GRIGIO	Ingresso digitale 1
5	GIALLO	DGND
6	VERDE	RS485-A
7	MARRONE	RS485-B

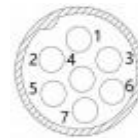

Fig. 8

Ad es., per abilitare il controllo esterno della velocità tramite ingresso digitale, collegare una delle cifre da PIN 1/2/3 a COM.

Quando PIN4 è collegato a Com, la pompa si arresta; se si scollega, il controllo digitale non sarà valido.

Quando PIN3 è collegato a Com, la pompa funziona a 2900 giri/min; se si scollega, la priorità di controllo tornerà al pannello.

Quando PIN2 è collegato a Com, la pompa funziona a 2400 giri/min; se si scollega, la priorità di controllo tornerà al pannello.

Quando PIN1 è collegato a Com, la pompa funziona a 1200 giri/min; se si scollega, la priorità di controllo tornerà al pannello.

## 5.5 Impostazione dei parametri

In modalità OFF, tenere premuti ▲▼ per 3 secondi per accedere alle impostazioni dei parametri.

Parametro	Descrizione	Impostazione predefinita	Intervallo di impostazione
1	Tempo di adescamento	1 minuto	0~10 min., con incrementi di 1 minuto
2	N. minimo di giri/min	1200 giri/min	1200~2000 giri/min, con incrementi di 100 giri/min
3	PIN3	2900 giri/min	1200~2900 giri/min, con incrementi di 100 giri/min
4	PIN2	2400 giri/min	1200~2900 giri/min, con incrementi di 100 giri/min
5	PIN1	1200 giri/min	1200~2900 giri/min, con incrementi di 100 giri/min
6	Velocità di adescamento	2900 giri/min	1200~2900 giri/min, con incrementi di 100 giri/min

## 6. PROTEZIONE E CODICI DI ERRORE

Articolo	Codice	Descrizione	Analisi
1	E001	Tensione di ingresso anomala	Non difettosa
2	E002	Sovracorrente uscita	Non difettosa
3	E101	Surriscaldamento dissipatore di calore	Contattare il fornitore
4	E102	Errore sensore dissipatore di calore	Contattare il fornitore
5	E103	Errore scheda driver master	Contattare il fornitore
6	E201	Errore circuito stampato	Contattare il fornitore
7	E202	Errore lettura EEPROM scheda master	Contattare il fornitore
8	E203	Errore lettura ora RTC	Contattare il fornitore
9	E204	Errore lettura EEPROM tastiera	Contattare il fornitore
10	E205	Errore di comunicazione	Contattare il fornitore
11	AL01	Riduzione automatica della velocità contro le alte temperature	Contattare il fornitore

*Nota:*

1. AL01 non è un'indicazione di errore: quando appare, l'inverter passa automaticamente a una velocità inferiore per autoprotettersi dall'elevata temperatura interna. Quando la temperatura torna a 68°C, l'inverter riprende a funzionare alla velocità preimpostata.

2. Una volta risolte le cause dei codici E002/E101/E103, il dispositivo riprende a funzionare automaticamente. Tuttavia, quando il messaggio appare una quarta volta, il dispositivo smette di funzionare; per rimetterlo in funzione occorre scollegare il dispositivo, ricollegarlo e riavviarlo.

## 7. ESCLUSIONI DI RESPONSABILITÀ

In nessun caso, il produttore potrà essere ritenuto responsabile di eventuali conseguenze derivanti da un'installazione inadeguata o errata oppure dall'abbinamento del prodotto a pompe per piscina non compatibili.

Il produttore si riserva il diritto di modificare le specifiche del prodotto, le rispettive prestazioni o il contenuto del manuale per l'uso senza preavviso in caso di aggiornamenti tecnici.

## 8. SMALTIMENTO



Questo simbolo è richiesto dalla Direttiva 2012/19/UE della Comunità Europea sui rifiuti di apparecchiature elettriche ed elettroniche (RAEE) e indica il divieto di gettare l'apparecchio in un normale contenitore. Occorre, invece, farne la raccolta differenziata a scopo di riutilizzo, riciclaggio o trasformazione. Eliminare o neutralizzare eventuali sostanze ivi contenute, che siano potenzialmente pericolose per l'ambiente. Per ulteriori informazioni sulle procedure di riciclaggio rivolgersi al proprio rivenditore.



# AQUASPHERE FREQUENZUMRICHTER

DE - BETRIEBSANLEITUNG



INHALTSVERZEICHNIS

1. WICHTIGE SICHERHEITSHINWEISE ..... 68

2. TECHNISCHE DATEN ..... 71

3. VOR DER INSTALLATION ..... 72

4. ANSCHLUSS AN DIE SCHWIMMBADPUMPE ..... 72

5. EINSTELLUNGEN UND BETRIEB ..... 77

6. SCHUTZ UND FEHLERCODES ..... 81

7. AUSSCHLÜSSE ..... 82

8. ENTSORGUNG ..... 82

SICHERHEITSSZEICHEN

	Betriebsanleitung lesen und an einem sicheren Ort aufbewahren
	Warnung
	Achtung: Stromschlagrisiko
	Kühlkörper nicht berühren
	Elektro- und Elektronik-Altgeräte: In einem Recyclingzentrum entsorgen.



## 1. WICHTIGE SICHERHEITSHINWEISE



### WICHTIGE INFORMATIONEN ZU SICHERHEIT, INSTALLATION UND WARTUNG

*Die komplette Betriebsanleitung kann als PDF-Datei auf dieser Website eingesehen und heruntergeladen werden [www.aquaspheremanuals.com](http://www.aquaspheremanuals.com)*



Für die optimale Nutzung dieses Energiespargeräts und zur Vermeidung von potenziellen Risiken wie Brand, Stromschlag, SCHWERE Körperverletzungen oder Sachschäden lesen Sie diese Betriebsanleitung bitte vor der Installation sorgfältig durch und bewahren Sie sie zur späteren Einsichtnahme auf.

Alle Arbeiten im Zusammenhang mit der Montage, der elektrischen Installation und Wartung müssen von qualifizierten und zugelassenen Fachkräften ausgeführt werden, die die Installations- und Instandhaltungsanweisungen sorgfältig durchgelesen haben.

- Dieses Gerät ist nicht für die Verwendung durch Personen (einschließlich Kindern) mit verminderten körperlichen, sensorischen oder geistigen Fähigkeiten oder fehlenden Erfahrungen oder Kenntnissen bestimmt, es sei denn, sie werden beaufsichtigt oder haben Anweisungen erhalten bezüglich der sicheren Verwendung des Geräts von einer für ihre Sicherheit verantwortliche Person.
- Kinder müssen beaufsichtigt werden, um sicherzustellen, dass sie nicht mit dem Gerät spielen.
- Dieses Gerät kann von Kindern im Alter von mindestens 8 Jahren und Personen mit verminderten körperlichen, sensorischen oder geistigen Fähigkeiten oder fehlenden Erfahrungen oder Kenntnissen verwendet werden, wenn sie beaufsichtigt werden oder Anweisungen bezüglich der sicheren Verwendung des Geräts erhalten haben und die diesem innewohnenden Gefahren verstehen.
- Kinder dürfen nicht mit diesem Gerät spielen.
- Die Reinigung und Benutzerwartung dürfen nicht von Kindern ohne Beaufsichtigung durchgeführt werden.
- Die Montage und Installation unseres Produkts ist nur in Schwimmbädern zulässig, welche die Normen IEC/HD 60364-7-702 und die vorgeschriebenen nationalen Regelungen erfüllen. Die Installation muss der Norm IEC/HD 60364-7-702 und den vorgeschriebenen nationalen Regelungen für Schwimmbäder entsprechen.

Für weitere Informationen wenden Sie sich bitte an Ihren lokalen Händler.

- Der Frequenzumrichter darf nicht in Zone 0 (Z0) oder Zone 1 (Z1) installiert werden. Zeichnungen sehen Sie auf Seite 2.
- Das Gerät muss an eine Wechselstromversorgung (siehe Angaben auf dem Typenschild des Frequenzumrichters) mit Erdung angeschlossen und durch eine Fehlerstrom-Schutzeinrichtung (RCD) mit einem Nennfehlerstrom von maximal 30mA geschützt werden.
- An der Festinstallation muss ein Trennschalter gemäß den Installationsvorschriften eingebaut werden.
- Es darf nur EINE Pumpe an den Frequenzumrichter angeschlossen werden. Keine anderen Geräte an den Ausgang anschließen.

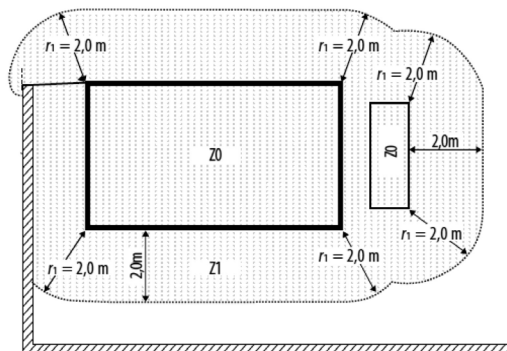
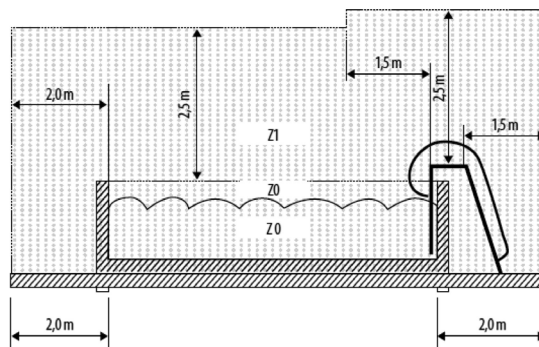
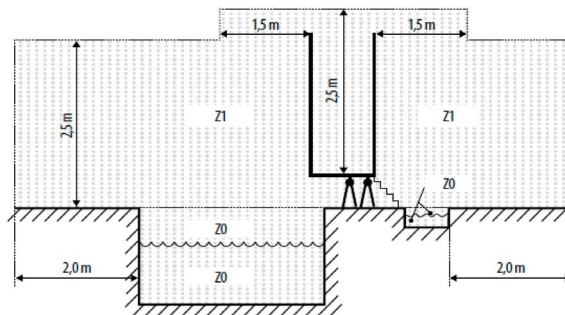



Dieses Gerät darf NUR bei Schwimmbadpumpen mit einem Motor mit Betriebskondensator verwendet werden. Das untenstehende Schaltbild zeigt einen typischen einstufigen Schwimmbadpumpenmotor.

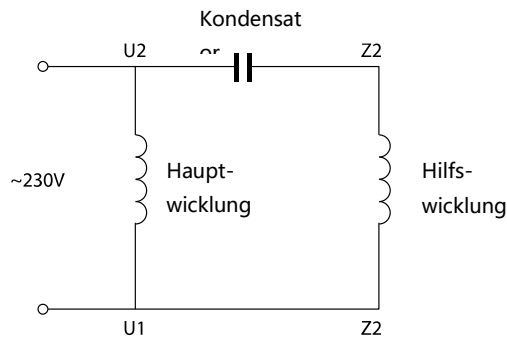

Fig.1

1.1 Es ist NICHT kompatibel mit:

- a. Ein- (Drei-) phasige Motoren mit Fliehkraftschalter.
- Schwimmbadpumpenmotoren mit Startrelais oder Schalter.
- c. Reihenschaltung oder Gleichstrommotoren.
- d. Schwimmbadpumpen-Motoren mit Störungen an Rotor oder Kondensatoren.
- e. Spaltpol-Asynchronmotoren.

1.2 Dieses Produkt muss stets mit einer Fehlerstrom-Schutzeinrichtung (RCD) mit einem Nennfehlerstrom von maximal 30mA verwendet werden.



Falls Sie hinsichtlich der Kompatibilität Ihrer Schwimmbadpumpe mit diesem Gerät Zweifel haben, wenden Sie sich bitte an Ihren Lieferanten oder Hersteller, bevor Sie mit der Installation fortfahren.



## 2. TECHNISCHE DATEN

### 2.1 Aquasphere Frequenzumrichter 1,1 kW

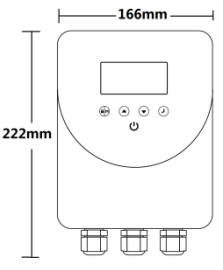
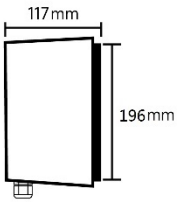
Modell	75947	Abmessungen
Eingangsleistung	1 Phase AC	
Eingangsspannung	220-240 V	
Eingangsfrequenz	50Hz	
Ausgangsleistung	Max 1,1 kW	
Ausgangsspannung	1 Phase, 0-240 V	
Pumpentyp	Einphasig	
Max. Strom	Max. 6 A	
Drehzahlbereich	1200~2900 rpm	
Kühlung	Ventilation	
Nettoabmessungen (LxHxB)	222x117x166 mm	

### 3. VOR DER INSTALLATION



Bei Erhalt des Geräts die Verpackung bzw. Produkt auf Beschädigungen prüfen. Mit der Installation NICHT FORTFAHREN, wenn Beschädigungen festgestellt werden: wenden Sie sich an Ihren Lieferanten.  
Für dieses Gerät keine Verlängerungskabel benutzen. Dieses kann insbesondere in der Nähe eines Schwimmbads eine Gefahr darstellen.

Stellen Sie sicher, dass der von Ihnen gewählte Installationsort die folgenden Bedingungen erfüllt:

- Umgebungstemperatur von  $-10\sim 40^{\circ}\text{C}$
- 45 bis 90 Prozent relative Luftfeuchtigkeit, nicht kondensierend
- Weniger als 1000 m über dem Meeresspiegel
- Nicht direkter Sonneneinstrahlung aussetzen
- Gute Belüftung

Für eine effiziente Kühlung bitte sicherstellen, dass das Gerät rundum mit ausreichend Freiraum installiert wird (Abb.2)

Eine blockierte Belüftung oder ein geschlossener Raum mit begrenzter Luftzufuhr kann zu Überhitzung oder potenziellem Betriebsausfall des Frequenzumrichters führen.

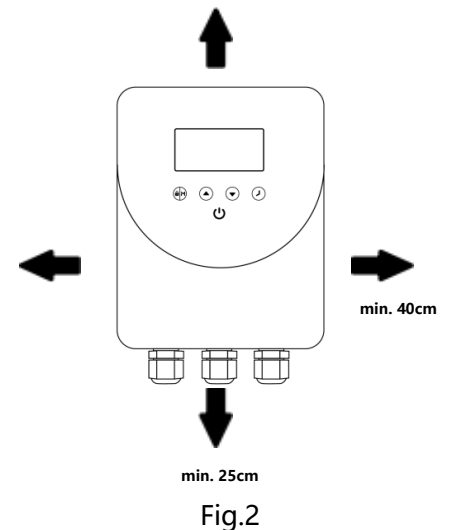

### 4. ANSCHLUSS AN DIE SCHWIMMBADPUMPE



Für einen korrekten Anschluss beachten Sie bitte die folgenden Schritte und den Schaltplan. Wird das Gerät nicht gemäß den in dieser Betriebsanleitung beschriebenen Anweisungen installiert, kann dies zu Garantieeinschränkungen führen.

Es darf nur EINE Pumpe an den Frequenzumrichter angeschlossen werden. Bitte keine anderen Geräte an den Ausgang anschließen.

Die Bohrlöcher an der Wand markieren, bohren und die mitgelieferten Spreizdübel einsetzen, Schrauben befestigen und das Gerät an die Schrauben hängen.

4.1 Die Stromzufuhr zur Schwimmbadpumpe unterbrechen, Stecker vom Hauptschalter oder beim Controller, welche die Pumpe mit Strom versorgt, ausstecken.

4.2 Den Stecker der Schwimmbadpumpe in den Ausgang (gekennzeichnet mit „PUMP CONNECTION ONLY“) am Frequenzumrichter stecken.

Es wird empfohlen, dass die Gesamtlänge des Geräteausgabekabels und des Stromkabels der Schwimmbadpumpe 2m nicht überschreitet.

4.3 Stecken Sie den Gerätestecker in den Hauptschalter /Controller/Timer Anschluss, an dem die Pumpe ursprünglich angeschlossen ist.

4.4 Zur Reduzierung von elektromagnetischen Interferenzen bitte das Erdungskabel anschließen, das am Kühlkörper befestigt ist (sollte der Ausgang des Frequenzumrichters keinen Stecker haben, muss er nicht angeschlossen werden)

4.5 Stromversorgung wieder herstellen.

4.6 Sicherstellen, dass Controller/Timer aktiviert ist.

4.7 Das Gerät ist nun betriebsbereit

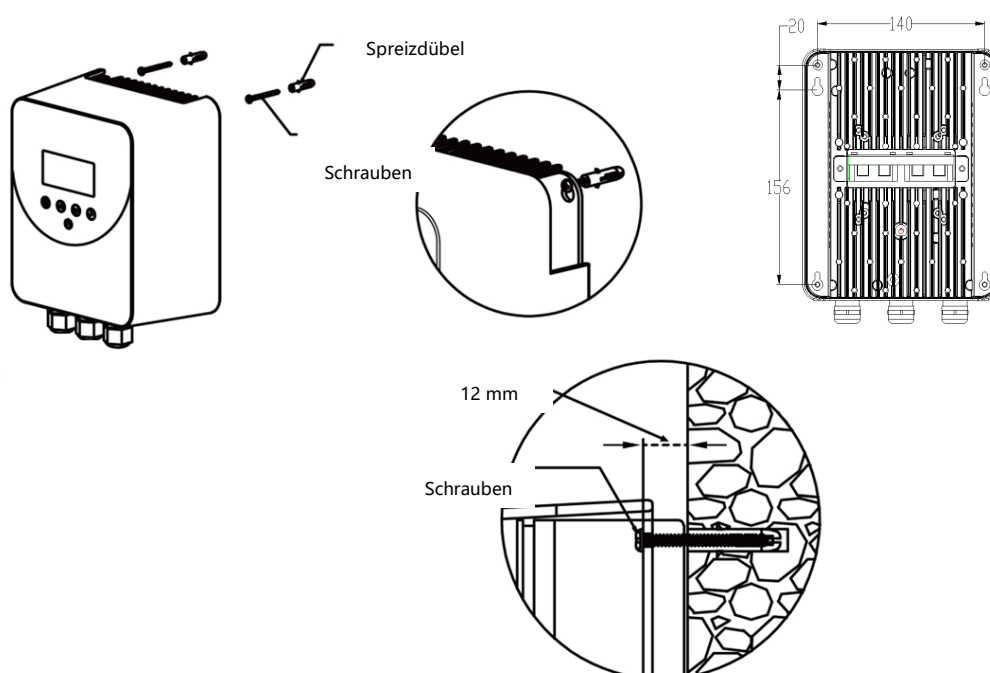

Fig.3

Die obige Abbildung dient nur als Beispiel, Stecker und Buchsen können je nach Land/Region variieren. Sollte die Pumpenbuchse bereits in Ihrem Gerät integriert sein, verkabeln Sie das Gerät wie in Abb. 4 und 5 dargestellt.

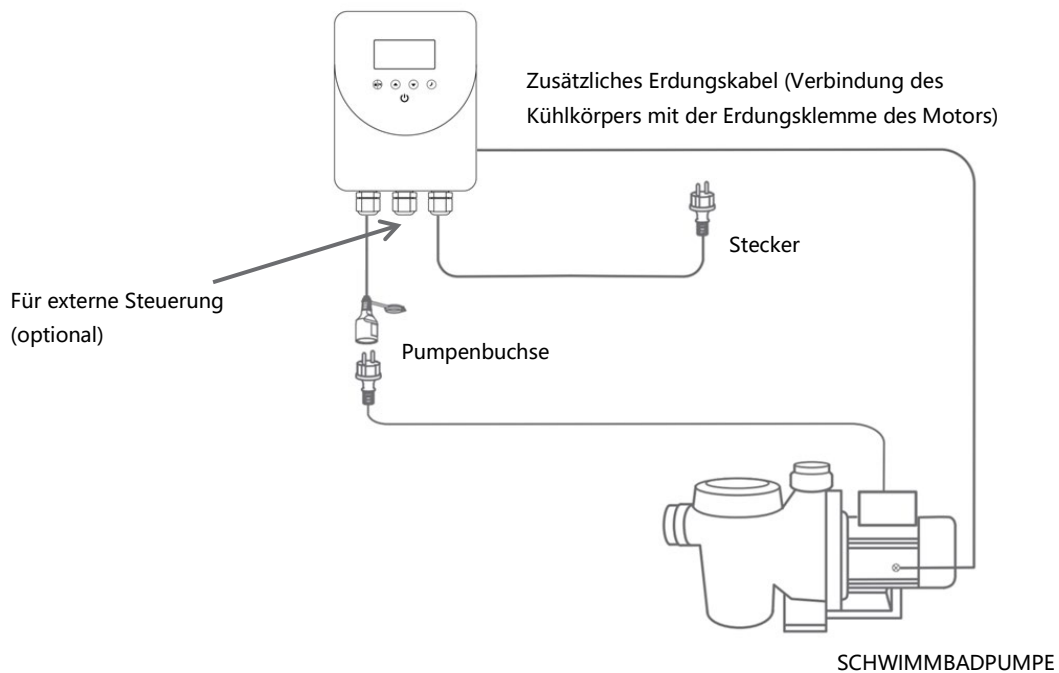

Fig.4

Die obige Abbildung dient nur als Beispiel, Stecker und Buchsen können in verschiedenen Ländern/Regionen variieren.



Abb.5 Erdungsleiter-Anschlusschema

Sollte die Pumpenbuchse nicht in Ihrem Gerät integriert sein, verkabeln Sie das Gerät wie in Abb. 6 und 7 dargestellt.



Abb. 6 1-ph Pumpenanschlussschema

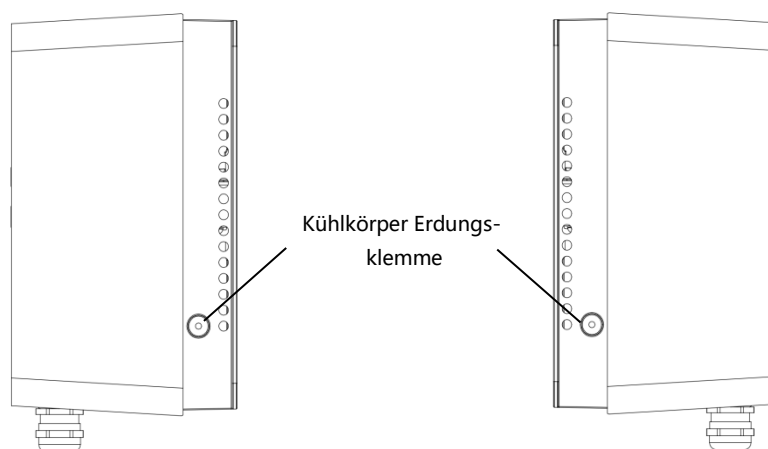

Abb. 7 3-ph Pumpenanschlussschema

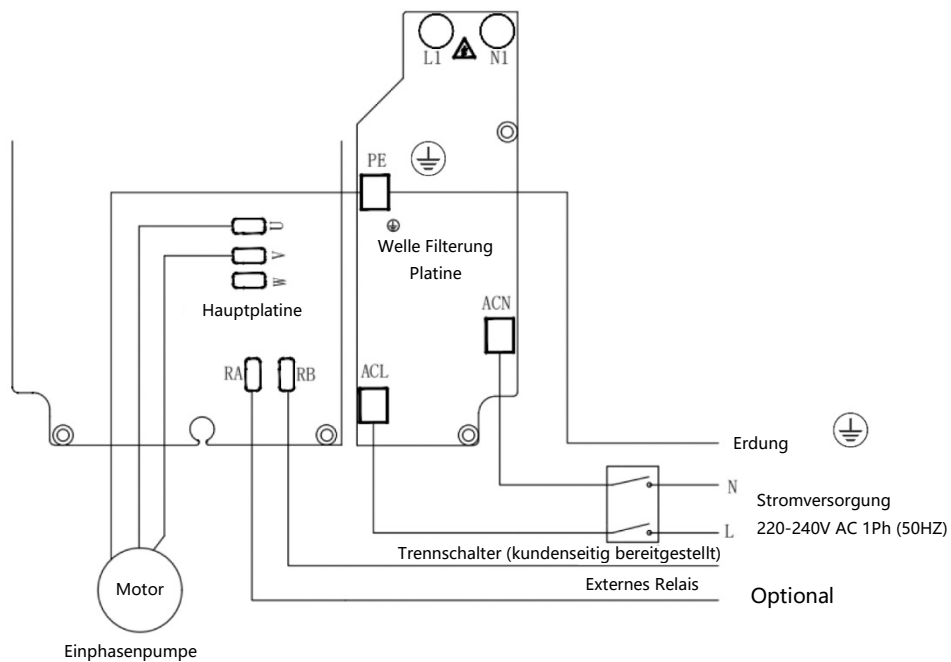
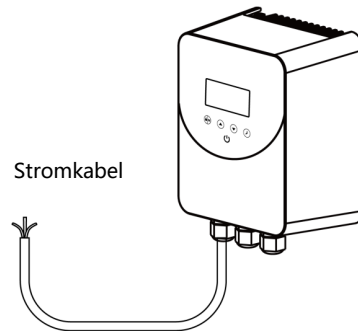

Kühlkörper nicht berühren, wenn das Gerät in Betrieb ist oder erst nachdem mindestens 30 min. vergangen sind, nachdem es ausgeschaltet wurde. Das Gerät außerhalb der Reichweite von Kindern halten.

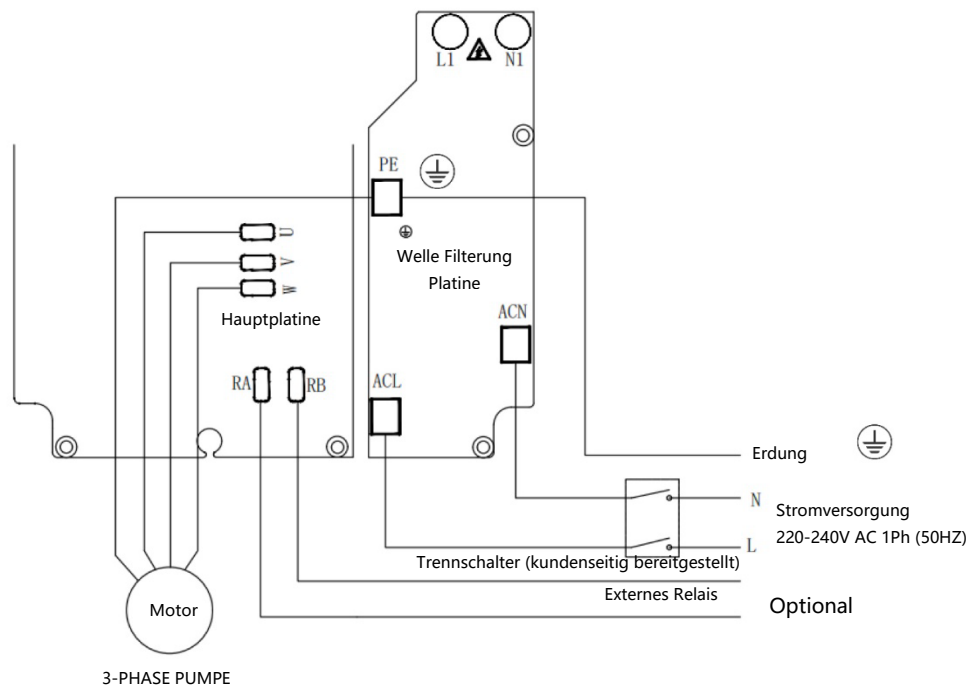

Aufgrund der Komponenten zur Hochspannungsänderung, die im Gerät enthalten sind, nicht versuchen, das Gerät zu zerlegen oder Komponenten auszutauschen, wenn es zu Fehlfunktionen oder Ausfällen kommt. Vor Instandhaltungsarbeiten am Gerät warten, bis die Betriebsanzeige des Geräts erlischt oder mindestens 3 Minuten, nachdem das Netzkabel von der Eingangsversorgung gezogen wurde.



Für 3 Phasen Frequenzumrichter, den Pumpenmotor mit Dreiecksschaltung anschließen.

## 5. EINSTELLUNGEN UND BETRIEB



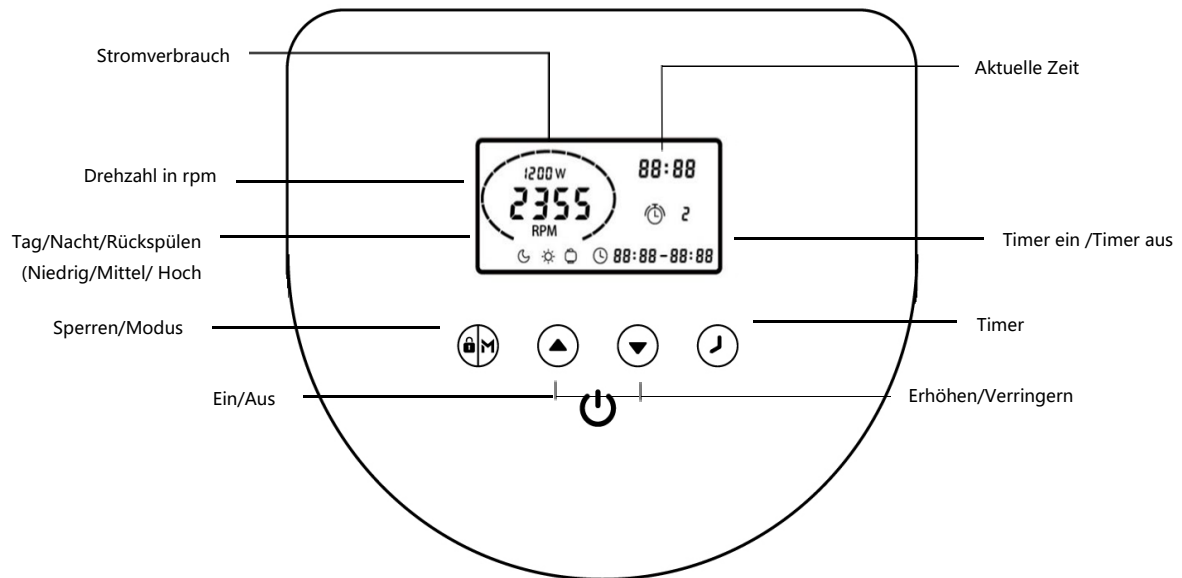



### 5.1 Bedienfeld



### 5.2 Modus Auswahl

Der Frequenzumrichter hat 3 Modi (Drehzahlbereiche). Sie können die Pumpe konstant auf einer Drehzahl laufen lassen, indem Sie „M “ drücken, oder bis zu 4 Timer für den täglichen Betrieb einstellen, jeden mit einer individuellen Drehzahl.

Modus	Drehzahlbereich	Voreingestellte Drehzahl
Nacht (Niedrig)	1200~1650 rpm	1400 rpm
Tag (Mittel)	1700~2400 rpm	2000 rpm
Rückspülen (Hoch)	2450~2900 rpm	2900 rpm

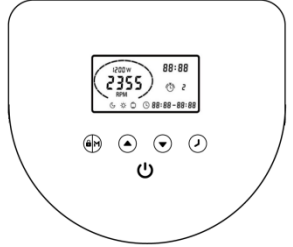
<p>① Wenn der Stecker eingesteckt ist, leuchtet  auf,  für 3 Sekunden gedrückt halten, um das Display zu entsperren. Zum Starten auf  drücken.</p> <p>② Beim Starten läuft die Pumpe auf maximaler Drehzahl 2900 rpm für eine Minute</p> <p>Selbstansaugung. (Dies kann auf bis zu 10 Minuten erhöht werden – siehe Parametereinstellungen Abschnitt 5.5)</p> <p>③  drücken zur Auswahl der Drehzahl, die  oder  Pfeile benutzen zur Anpassung in 50rpm-Schritten, bis die spezifische Drehzahl erreicht ist.</p>	
---	---







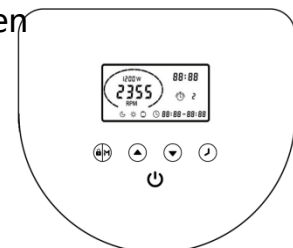

Sobald die Pumpe die Selbstansaugung beendet hat, schaltet der Umrichter automatisch die Pumpe auf die voreingestellte Drehzahl,  zeigt an, dass die Pumpe läuft und zeigt die aktuelle rpm und Stromverbrauch.

### 5.3 Timer Einstellung

Um die Pumpe zu verschiedenen Zeiten oder Drehzahlen laufen zu lassen, um die niedrigeren Stromtarife in der Nacht nutzen zu können, ist die Einstellung von bis zu 4 Timern möglich.



Schritt1  drücken, um Timer Einstellung zu öffnen.

Schritt2 : Mit  oder  die aktuelle Zeit einstellen.  drücken um den Cursor zur nächsten Einstellung zu bewegen.  drücken, um Drehzahlbereich Timer 1 zu wählen,  oder  benutzen, um eine spezifische Drehzahl festzulegen, falls erforderlich.   Drücken, um den Cursor zur vorherigen Einstellung zu bewegen.

Schritt3 : für die Einstellung der anderen 3 Timer die obenstehenden Schritte wiederholen.

Schritt4:  für 3 Sekunden gedrückt halten oder 10 Sekunden warten, um die Einstellungen automatisch zu speichern.

Das Blinken von  **88:88 - 88:88** zeigt an, dass das Gerät auf die Startzeit wartet.



Schritt5: ▲ oder ▼ drücken, um alle 4 Timer zu kontrollieren und sicherzustellen, dass keine ungültige Einstellung besteht.

\* Überschneidungen in den Timer-Zeitabschnitten gelten als ungültig; das Gerät läuft nur auf Grundlage der vorherigen gültigen Timer-Einstellung.

\* Wenn Sie während der Timer Einstellung abbrechen möchten, ⊞ für 3 Sekunden gedrückt halten.

Hinweis:

\* Bei Inaktivität für 1 Minute sperrt das Display automatisch. ⊞ für 3 Sekunden gedrückt halten, um das Gerät zu entsperren.

\* Das Gerät verfügt über einen Speicher bei Stromausfall, der Vorgang wird fortgesetzt, wenn die Stromversorgung wiederhergestellt ist.

\* Im OFF-Modus, ▲ ↻ für 3 Sekunden gedrückt halten, um auf die Werks-einstellungen zurückzusetzen.

## 5.4 Externe Steuerung (optional)

Die externe Steuerung kann über die folgenden Kontakte aktiviert werden. Auch wenn das Gerät über einen externen Controller betrieben wird, kann es durch Drücken auf  gestoppt werden.

Bitte keine Spannung an diese Eingänge anlegen.

PIN	Draht Farbe	Signal Beschreibung
1	ROT	Digitaler Eingang 4
2	SCHWARZ	Digitaler Eingang 3
3	WEISS	Digitaler Eingang 2
4	GRAU	Digitaler Eingang 1
5	GELB	DGND
6	GRÜN	RS485-A
7	BRAUN	RS485-B



Abb. 8

Beispiel: Um die externe Drehzahlsteuerung über den digitalen Eingang zu aktivieren, die Stellen von PIN 1/2/3 mit COM verbinden.

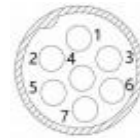

Wenn PIN4 mit Com verbunden ist, wird die Pumpe stoppen; wenn sie getrennt sind, ist die digitale Steuerung ungültig;

Wenn PIN3 mit Com verbunden ist, wird die Pumpe auf 2900 RPM laufen; wenn sie getrennt sind, liegt die Steuerungspriorität wieder beim Bedienfeld;

Wenn PIN2 mit Com verbunden ist, wird die Pumpe auf 2400 RPM laufen; wenn sie getrennt sind, liegt die Steuerungspriorität wieder beim Bedienfeld;

Wenn PIN1 mit Com verbunden ist, wird die Pumpe auf 1200 RPM laufen; wenn sie getrennt sind, liegt die Steuerungspriorität wieder beim Bedienfeld;

## 5.5 Parametereinstellung

Im OFF-Modus,   für 3 Sekunden gedrückt halten, um die Parametereinstellungen zu öffnen.

Parameter	Beschreibung	Voreinstellung	Einstellbereich
1	Ansaugzeit	1 Minuten	0~10min, in Schritten von 1 Minute
2	Minimum RPM	1200rpm	1200~2000rpm, in Schritten von 100rpm
3	PIN3	2900rpm	1200~2900rpm, in Schritten von 100rpm
4	PIN2	2400rpm	1200~2900rpm, in Schritten von 100rpm
5	PIN1	1200rpm	1200~2900rpm, in Schritten von 100rpm
6	Selbstansaugung Drehzahl	2900rpm	1200~2900rpm, in Schritten von 100rpm

## 6. SCHUTZ UND FEHLERCODES

Artikel	Code	Beschreibung	Analyse
1	E001	Anormale Eingangsspannung	Nicht fehlerhaft
2	E002	Ausgangs-Überstrom	Nicht fehlerhaft
3	E101	Kühlkörper überhitzt	Kontaktieren Sie Ihren Lieferanten
4	E102	Kühlkörper Sensorfehler	Kontaktieren Sie Ihren Lieferanten
5	E103	Master Treiberplatine Fehler	Kontaktieren Sie Ihren Lieferanten
6	E201	Platine Fehler	Kontaktieren Sie Ihren Lieferanten
7	E202	Masterplatine EEPROM Ablesefehler	Kontaktieren Sie Ihren Lieferanten
8	E203	RTC Zeit Ablesefehler	Kontaktieren Sie Ihren Lieferanten
9	E204	Tastatur EEPROM Ablesefehler	Kontaktieren Sie Ihren Lieferanten
10	E205	Kommunikation Fehler	Kontaktieren Sie Ihren Lieferanten
11	AL01	Automatische Drehzahlreduzierung gegen Übertemperatur	Kontaktieren Sie Ihren Lieferanten

### *Hinweis:*

1. AL01 ist keine Fehleranzeige: wenn sie erscheint, schaltet der Frequenzumrichter automatisch auf eine niedrigere Drehzahl, um sich selbst gegen hohe interne Temperaturen zu schützen. Fällt die Temperatur zurück auf 68°C, setzt der Frequenzumrichter die voreingestellte Drehzahl wieder fort.
2. Wenn Ursachen für E002/E101/E103 behoben werden, geht das Gerät automatisch wieder in Betrieb; sollte es jedoch zum vierten Mal erscheinen, stellt das Gerät den Betrieb ein; um den Betrieb wieder herzustellen, Stecker ziehen, wieder einstecken und neu starten.

## 7. AUSSCHLÜSSE

Unter keinen Umständen kann der Hersteller für Folgen haftbar gemacht werden, die sich aus einer unsachgemäßen, falschen Installation oder dem fehlerhaften Einsatz des Produkts mit nicht kompatiblen Schwimmbadpumpen ergeben.

Der Hersteller behält sich das Recht vor, die Spezifikationen des Produkts, dessen Leistung oder die Inhalte der Betriebsanleitung im Falle einer technischen Aktualisierung ohne Ankündigung zu ändern.

## 8. ENTSORGUNG



Dieses Symbol ist durch die Richtlinie 2012/19/EU der Europäischen Gemeinschaft zu Elektro- und Elektronik-Altgeräten (WEEE) vorgeschrieben und bedeutet, dass Ihr Gerät nicht im normalen Müll entsorgt werden darf. Es wird separat zur Wiederverwendung, zum Recyceln oder zur Umbearbeitung gesammelt. Alle möglicherweise enthaltenen Substanzen, die potenziell umweltschädlich sind, müssen beseitigt oder neutralisiert werden. Wenden Sie sich für Informationen zu Recyclingverfahren an Ihren Händler.

AQUA  
SPHERE

# CONTROLADOR DO INVERSOR AQUASPHERE

PT - MANUAL DE INSTRUÇÕES



ÍNDICE

1. INSTRUÇÕES DE SEGURANÇA IMPORTANTES .....85

2. ESPECIFICAÇÕES TÉCNICAS .....88

3. ANTES DA INSTALAÇÃO .....89

4. LIGAÇÃO À BOMBA DA PISCINA .....89

5. DEFINIÇÕES & FUNCIONAMENTO .....94

6. PROTEÇÃO & CÓDIGOS DE ERRO .....98

7. EXCLUSÕES .....99

8. ELIMINAÇÃO .....99

SÍMBOLOS DE SEGURANÇA

	Leia e conserve o manual num local seguro
	Aviso
	Precaução: Risco de choque elétrico
	Não toque no dissipador de calor
	Resíduos eletrônicos: Elimine num centro de reciclagem apropriado



## 1. INSTRUÇÕES DE SEGURANÇA IMPORTANTES



### INFORMAÇÃO IMPORTANTE SOBRE SEGURANÇA, INSTALAÇÃO E MANUTENÇÃO

*Poderá ler e descarregar o manual completo em ficheiro PDF do site: [www.aquaspheremanuals.com](http://www.aquaspheremanuals.com)*



Para fazer o melhor deste dispositivo de poupança de energia, e com o fim de evitar potenciais riscos de incêndio, choque elétrico, LESÕES GRAVES em pessoas ou danos materiais, leia atentamente o presente manual de instruções antes de proceder à instalação, e guarde-o para futuras consultas.

- Qualquer montagem, instalação elétrica e trabalho de manutenção deverá ser levado a cabo por pessoal qualificado devidamente autorizado que tenha lido atentamente as correspondentes instruções de instalação e manutenção.
- Este aparelho não se destina a ser utilizado por pessoas (incluindo crianças) com capacidades físicas, sensoriais ou mentais reduzidas, ou com falta de experiência ou conhecimentos, a não ser que recebam supervisão ou instruções sobre a utilização do aparelho por alguém responsável pela sua segurança.
- As crianças devem ser supervisionadas de modo a garantir que não brincam com o aparelho.
- Este aparelho pode ser utilizado por crianças com idade igual ou superior a 8 anos e por pessoas com capacidades físicas, sensoriais ou mentais reduzidas ou com falta de experiência e conhecimentos se receberem supervisão ou instruções sobre a utilização segura do aparelho e se compreenderem os perigos envolvidos.
- As crianças não devem brincar com o aparelho.
- A limpeza e a manutenção não deverão ser realizadas por crianças sem a devida supervisão.
- O nosso produto só pode ser montado e instalado em piscinas que cumpram as normas IEC/HD 60364-7-702 e a regulamentação nacional exigida. A instalação deve seguir a norma IEC/HD 60364-7-702 e a regulamentação nacional exigida em matéria de piscinas.

Consulte o seu revendedor local para obter mais informações.

- O controlador do inversor não pode ser instalado na Zona 0 (Z0) ou Zona 1 (Z1). Para ver os desenhos consulte a página 2.
- O aparelho deve ser ligado a uma alimentação em corrente alternada (consulte os dados na placa de características do controlador do inversor) com ligação à terra protegida por um dispositivo de corrente residual (RCD) com uma corrente de funcionamento residual que não ultrapasse os 30 mA.
- Um seccionador deve ser instalado na instalação elétrica fixa de acordo com os regulamentos de instalação.
- Só se pode ligar UMA bomba ao inversor. Não ligue qualquer outro aparelho à saída.

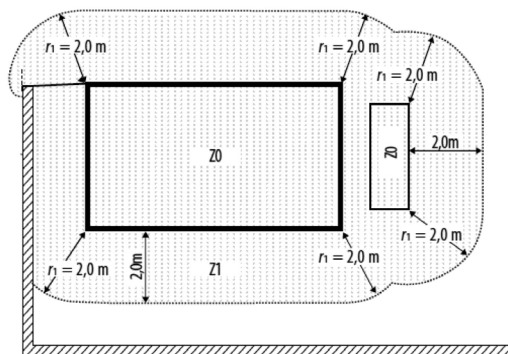
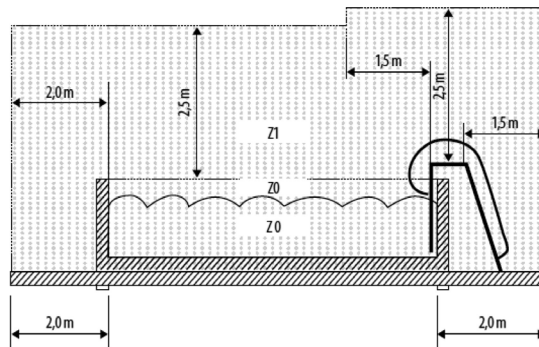
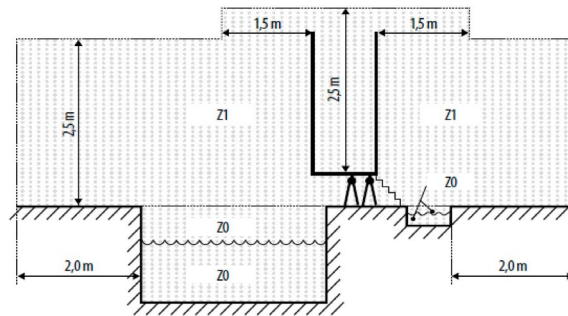





Este dispositivo SÓ pode ser utilizado com bombas de piscina com motor de condensador com divisão permanente. O diagrama esquemático abaixo mostra um motor de bomba de piscina de uma só velocidade típico.

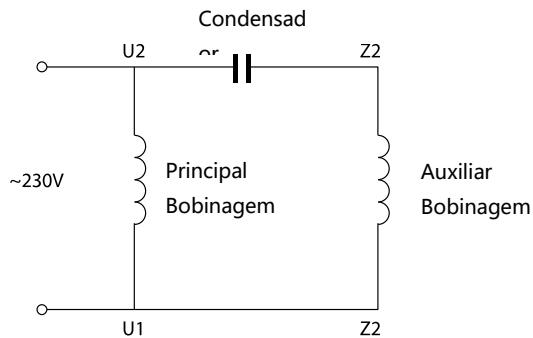

Fig.1

### 1.1 NÃO é compatível com:

- a. Motores monofásicos ou trifásicos com interruptor centrífugo.
- b. Motor de bomba de piscina com relés ou interruptor de arranque.
- c. Motores série ou DC.
- d. Motores de bomba de piscina com falhas nos rotores ou nos condensadores.
- e. Motores assíncronos de polos sombreados.

1.2 Deverá ser utilizado com este produto um RCD com uma corrente nominal residual que não exceda os 30 mA.



Se não tem a certeza da compatibilidade da sua bomba de piscina com este dispositivo, contacte com o seu fornecedor ou fabricante antes de levar a cabo a instalação.

## 2. ESPECIFICAÇÕES TÉCNICAS

### 2.1 Controlador do inversor 1,1 kW Aquasphere

Modelo	75947	Dimensões
Potência de entrada	AC monofásico	
Tensão de entrada	220-240 V	
Frequência de entrada	50 Hz	
Potência de saída	Máx. 1,1 kW	
Tensão de saída	monofásico, 0-240 V	
Tipo de bomba	Monofásica	
Corrente máx.	Máx. 6 A	
Gama de velocidade	1200~2900 rpm	
Refrigeração	Ventilação	
Dimensões (C*A*L)	222*117*166 mm	

### 3. ANTES DA INSTALAÇÃO



Quando receber este dispositivo, examine para detetar possíveis danos na embalagem ou no produto.

**NÃO LEVE A CABO A INSTALAÇÃO** se detetar qualquer dano; contacte com o seu fornecedor.

Não utilize extensões com o dispositivo. Tal acarreta um perigo, principalmente nas proximidades da piscina.

Assegure-se de que o local que escolher para instalação satisfaz as seguintes condições:

- Temperatura ambiente de 10~40 °C
- 40% a 90% de humidade relativa, sem condensação
- Menos de 1000 m acima do nível do mar
- Afastado da luz solar direta
- Boa ventilação

Para um arrefecimento eficiente, assegure-se de o que o aparelho conta com um espaço livre mínimo à volta (Fig. 2)

Uma ventilação bloqueada ou um espaço fechado com um fluxo de ar limitado poderá causar sobreaquecimento ou uma potencial avaria do inversor.

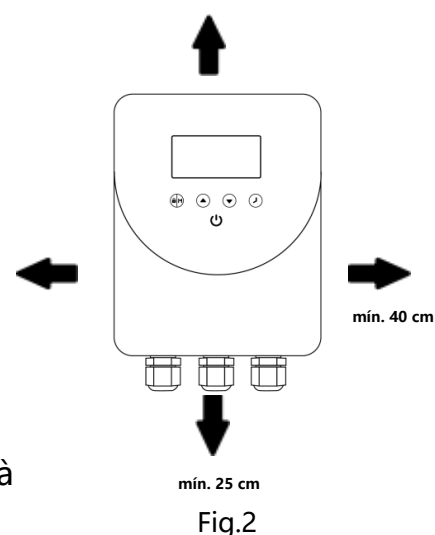

### 4. LIGAÇÃO À BOMBA DA PISCINA



Siga as instruções a seguir e o esquema de cablagem para uma ligação correta. A garantia poderá

ficar anulada se o dispositivo não for instalado de acordo com as instruções contidas no presente manual.

Só se pode ligar UMA bomba ao inversor. Não ligue qualquer outro aparelho à saída.

Marque os lugares dos orifícios na parede, faça os furos e introduza as buchas fornecidas, coloque os parafusos e pendure o dispositivo nos mesmos.

4.1 Desligue qualquer fonte de alimentação da bomba da piscina, desligue-o do interruptor geral ou do clorador que fornece energia elétrica à bomba.

4.2 Ligue a bomba da piscina ao saída de potência do aparelho (marcado com "APENAS LIGAÇÃO DA BOMBA" ).

Recomenda-se que o comprimento total da linha de saída do equipamento e a linha de alimentação da bomba da piscina não exceda os 2 metros.

4.3 Ligue o dispositivo ao conector do interruptor geral/clorador/temporizador onde originalmente estava ligada a bomba.

4.4 Para reduzir o impacto de interferências eletromagnéticas, ligue o fio de terra, fixo no dissipador de calor, ao motor da bomba da piscina (se a saída do inversor de frequência não tiver uma ficha, não é necessário efetuar a ligação)

4.5 Volte a ligar a alimentação elétrica.

4.6 Certifique-se de que o clorador/temporizador está ligado.

4.7 O dispositivo está agora pronto a funcionar

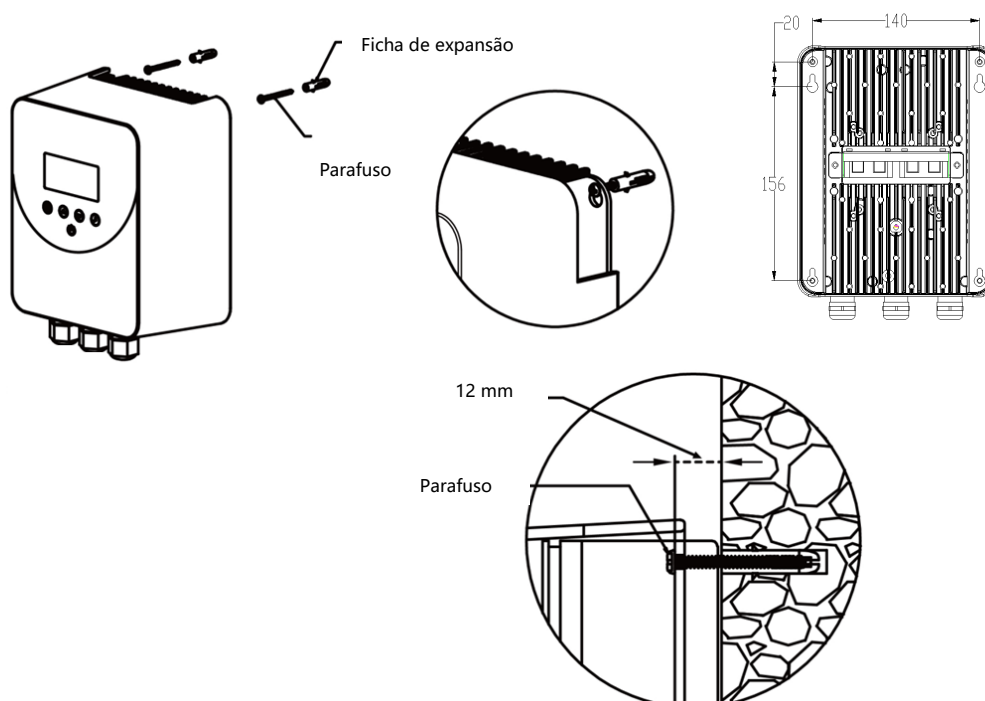

Fig.3

A figura acima serve apenas de referência, já que a ficha e a tomada poderão variar consoante o país/região.

Se a tomada da bomba já estiver incluída no seu dispositivo, faça a cablagem tal como se mostra nas Fig. 4 e 5.

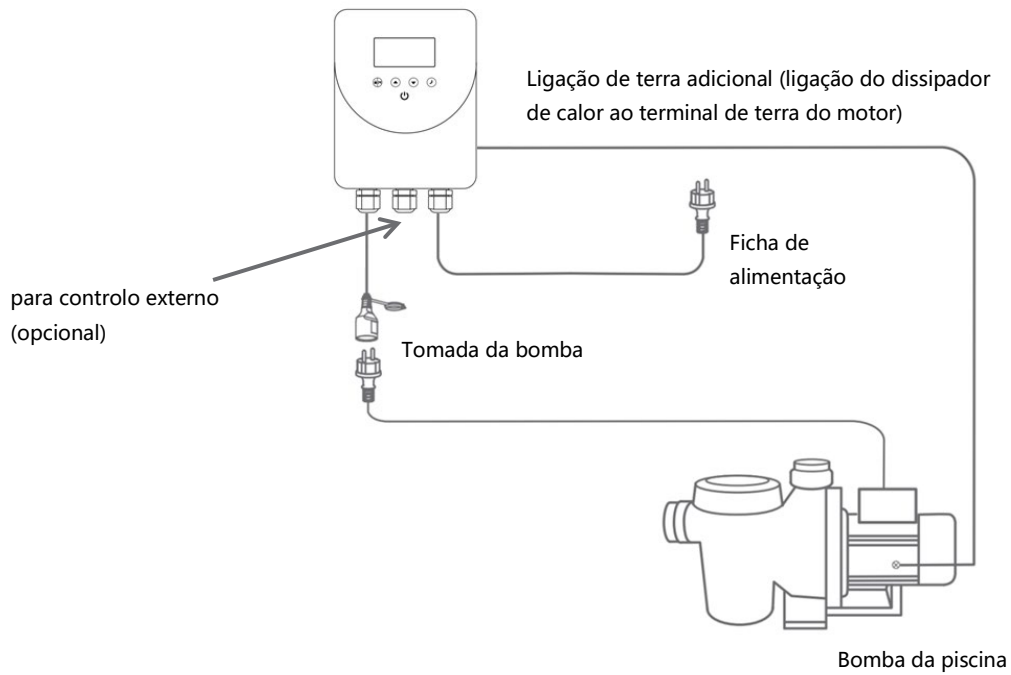

Fig.4

A figura acima serve apenas de referência, já que a ficha e a tomada poderão variar consoante o país/região.

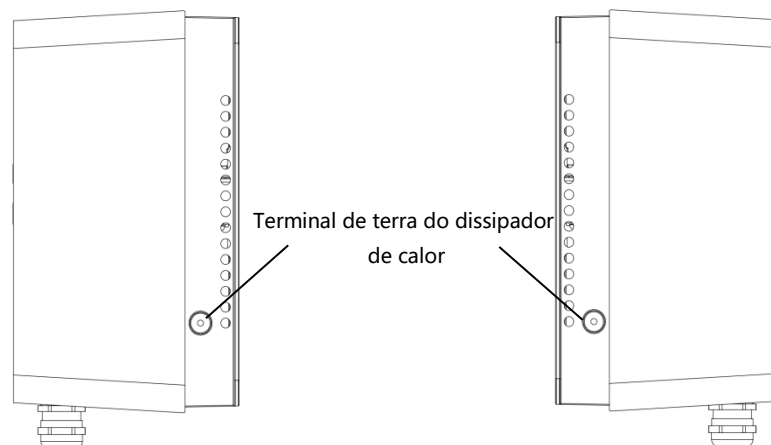

Fig. 5 Diagrama do terminal do fio-terra

Se a tomada da bomba não estiver incluída no seu dispositivo, faça a cablagem tal como se mostra nas Fig. 6 e 7.

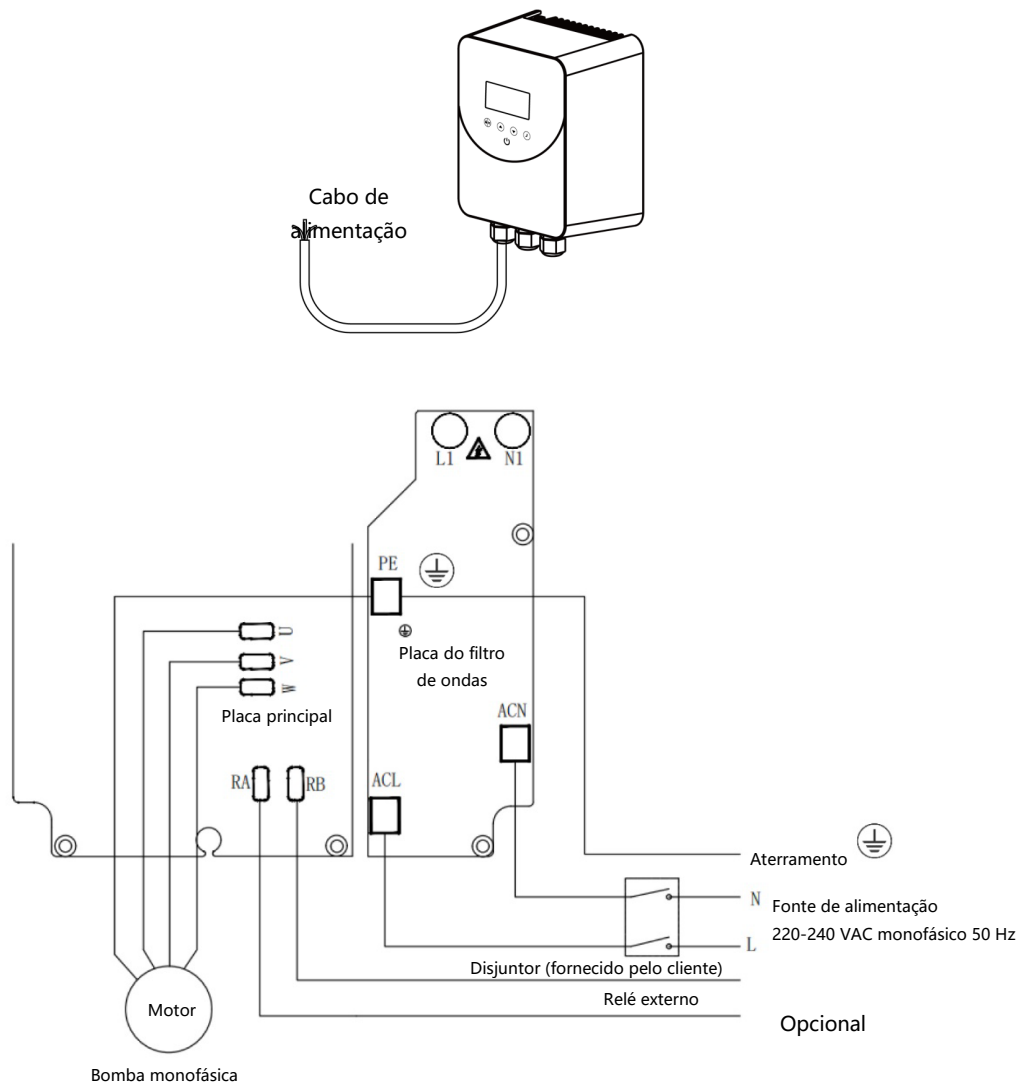

Fig. 6 Diagrama de ligação monofásica da bomba

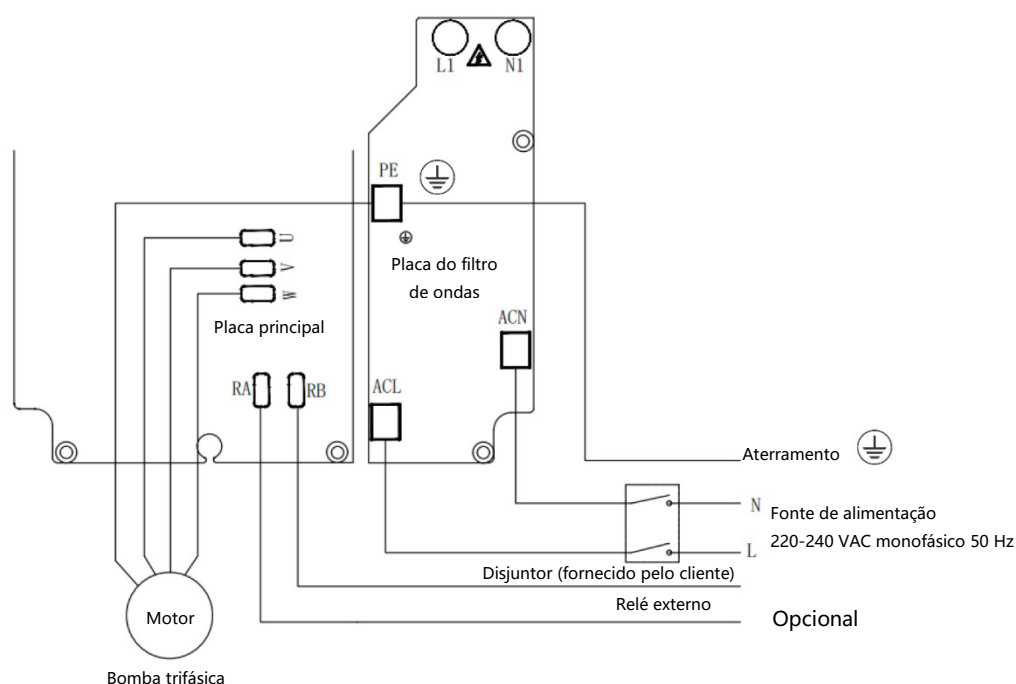

Fig. 7 Diagrama de ligação trifásica da bomba



Não toque no dissipador de calor enquanto o dispositivo estiver em funcionamento, ou espere pelo menos 30 minutos após ter desligado o mesmo. Mantenha o aparelho fora do alcance das crianças.



Dado que o dispositivo contém componentes de conversão de alta tensão, não tente desmontar nem substituir quaisquer componentes em caso de mau funcionamento ou avaria. Antes de realizar qualquer trabalho de manutenção do aparelho, espere até a luz de funcionamento se ter desligado ou pelo menos 3 minutos após a ficha de alimentação ter sido desligada da fonte de alimentação.



Para o controlador de inversor trifásico, ligue o motor da bomba com uma ligação delta.

## 5. DEFINIÇÕES & FUNCIONAMENTO

### 5.1 Painel de controlo

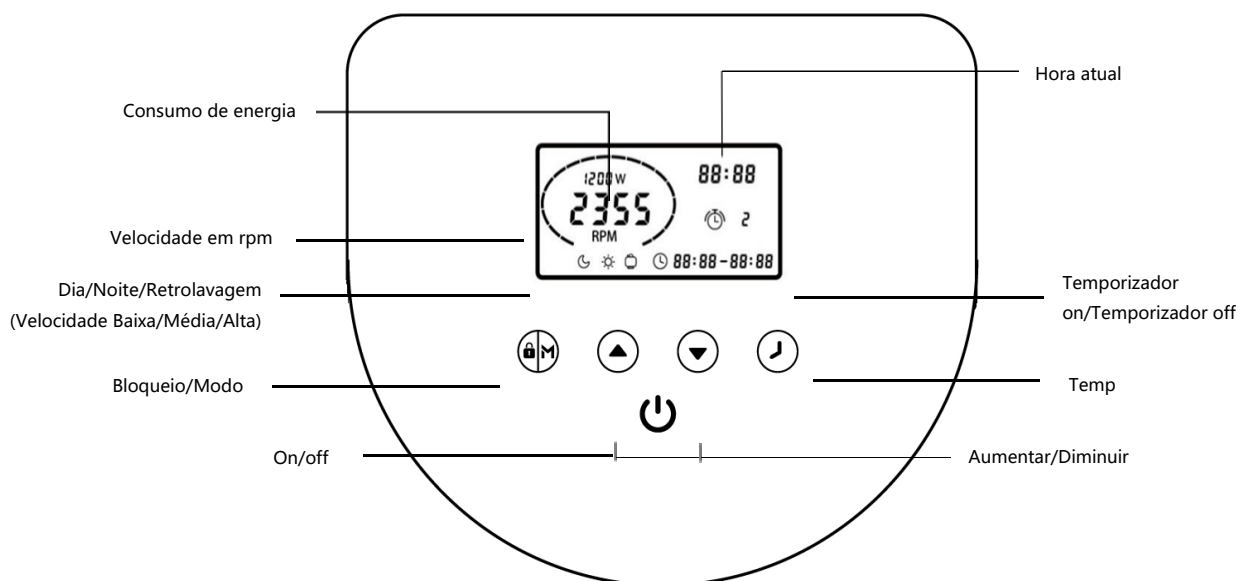









### 5.2 Seleção do Modo

O inversor de frequência conta com 3 modos (gamas de velocidade). Poderá operar a bomba a uma velocidade constante escolhendo em "M" ou programando 4 temporizadores para o funcionamento diária, cada um deles com uma velocidade individual.

Modo	Gama de velocidade	Velocidade predefinida
Noite (Baixa)	1200~1650 rpm	1400 rpm
Dia (Média)	1700~2400 rpm	2000 rpm
Retrolavagem (Alta)	2450~2900 rpm	2900 rpm

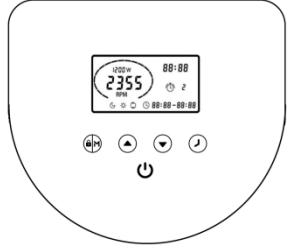



<p>① Uma vez ligado à corrente,  ilumina-se, mantenha premido  durante 3 segundos para desbloquear o ecrã. Prima  para começar.</p> <p>② Ao arrancar, a bomba irá funcionar à velocidade máxima de 2900 rpm durante a autoferragem de 1 minuto. (Este tempo pode ser aumentado para 10 minutos – ver Secção 5.5 Definição dos parâmetros)</p> <p>③ Prima  para escolher uma velocidade de funcionamento, use as setas  ou  para definir em frações de 50 rpm uma velocidade específica, se for necessário.</p>	
--	---





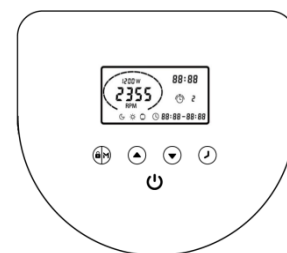



Quando a bomba terminar a ferragem, o inversor irá ativar automaticamente a bomba à velocidade predefinida,  indica que a bomba está a funcionar e mostra as rpm atuais e o consumo de energia.

### 5.3 Definição do temporizador

Para utilizar a bomba em momentos diferentes ou a velocidades diferentes para usufruir das tarifas de eletricidade mais baixas durante a noite, poderá definir 4 temporizadores.





Passo 1: Prima  para definir o temporizador.

Passo 2 : Use  ou  para definir a hora atual. Prima  para mover o cursor para a definição seguinte. Prima  para escolher uma gama de velocidade para o temporizador 1, use  ou  para definir uma velocidade específica, se for necessário. Prima   para mover o cursor para a definição anterior.

Passo 3: Repita os passos acima para definir os outros 3 temporizadores.

Passo 4 : Mantenha premida  durante 3 segundos ou espere 10 segundos para guardar as definições automaticamente.

 **88:88 - 88:88** intermitente indica que o dispositivo aguarda a hora de início.

Passo 5: Prima  ou  para verificar os 4 temporizadores e assegurar-se de que não há definições inválidas.



\* Os períodos do temporizador que se sobrepuserem serão considerados inválidos, e o dispositivo só funcionará com base na definição de temporizador válida anterior.

\* Durante a definição do temporizador, se desejar abandonar, mantenha premida  3 segundos.

Nota:

\* Se estiver sem atividade durante 1 minuto, o ecrã bloquear-se-á. Mantenha premida  durante 3 segundos para desbloquear o dispositivo.

\* O dispositivo tem memória em estado desligado, retomar-se-á o funcionamento quando voltar a haver alimentação elétrica.

\* No modo OFF, mantenha premida   durante 3 segundos para voltar às definições de fábrica.

## 5.4 Controlo externo (Opcional)

O controlo externo pode ser ativado através dos seguintes contactos. No entanto, inclusive se funcionar através de um controlo externo, se premir  poderá parar o dispositivo.

Não aplique tensão a estas entradas.

PIN	Cor do fio	Descrição do sinal
1	VERMELHO	Entrada digital 4
2	PRETO	Entrada digital 3
3	BRANCO	Entrada digital 2
4	CINZENTO	Entrada digital 1
5	AMARELO	DGND
6	VERDE	RS485-A
7	CASTANHO	RS485-B

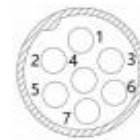

Fig. 8

Ex.: Para permitir o controlo externo da velocidade através de entrada digital, ligue um dos dígitos de PIN 1/2/3 a COM.



Quando o PIN4 estiver ligado a Com, a bomba irá parar; se estiver desligado, o controlo digital será inválido;

Quando o PIN3 estiver ligado a Com, a bomba irá funcionar a 2900 RPM; se estiver desligado, a prioridade de controlo voltará para o controlo do painel;

Quando o PIN2 estiver ligado a Com, a bomba irá funcionar a 2400 RPM; se estiver desligado, a prioridade de controlo voltará para o controlo do painel;

Quando o PIN1 estiver ligado a Com, a bomba irá funcionar a 1200 RPM; se estiver desligado, a prioridade de controlo voltará para o controlo do painel;

## 5.5 Definição dos parâmetros

No modo OFF, prima e mantenha pressionada a tecla   durante 3 segundos para entrar no modo de definição dos parâmetros.

Parâmetro	Descrição	Ajuste predefinido	Ajuste da gama
1	Tempo de ferragem	1 minuto	0~10 min, em frações de 1 minuto
2	RPM mínimo:	1200rpm	1200~2000 rpm, em frações de 100 rpm
3	PIN3	2900rpm	1200~2900 rpm, em frações de 100 rpm
4	PIN2	2400rpm	1200~2900 rpm, em frações de 100 rpm
5	PIN1	1200rpm	1200~2900 rpm, em frações de 100 rpm
6	Velocidade de autoferragem	2900rpm	1200~2900 rpm, em frações de 100 rpm

## 6. PROTEÇÃO E CÓDIGOS DE ERRO

Item	Código	Descrição	Análise
1	E001	Tensão de entrada anormal	Sem avaria
2	E002	Sobrecorrente de saída	Sem avaria
3	E101	Sobreaquecimento do dissipador de calor	Contacte com o seu fornecedor
4	E102	Erro no sensor do dissipador de calor	Contacte com o seu fornecedor
5	E103	Erro na placa controladora principal	Contacte com o seu fornecedor
6	E201	Erro na placa de circuitos	Contacte com o seu fornecedor
7	E202	Erro de leitura EEPROM na placa base	Contacte com o seu fornecedor
8	E203	Erro de leitura do tempo RTC	Contacte com o seu fornecedor
9	E204	Erro de leitura EEPROM no teclado	Contacte com o seu fornecedor
10	E205	Erro de comunicação	Contacte com o seu fornecedor
11	AL01	Redução automática da velocidade perante temperatura elevada	Contacte com o seu fornecedor

### *Nota:*

1. AL01 não é uma indicação de erro: quando aparecer, o inversor vai mudar automaticamente para uma velocidade mais baixa para se proteger de temperaturas internas elevadas. Quando a temperatura volta a descer até 68 °C, o inversor voltará a funcionar à velocidade predefinida.

2. Quando as causas de E002/E101/E103 desaparecem, o dispositivo retoma o funcionamento automaticamente, mas, quando aparecem pela quarta vez, o dispositivo para de funcionar. Para retomar o funcionamento, desligue a ficha do dispositivo da tomada, volte a ligar a ficha e volte a reiniciá-lo.

## 7. EXCLUSÕES

Em nenhuma circunstância deverá o fabricante ser considerado responsável por quaisquer consequências derivadas da utilização inapropriada ou incorreta do produto, ou da utilização do produto com bombas de piscina não compatíveis.

O fabricante reserva-se o direito de modificar as especificações do produto ou o desempenho do mesmo, assim como os conteúdos do presente Manual do Utilizador sem aviso prévio em caso de atualização técnica.

## 8. ELIMINAÇÃO



Este símbolo é exigido pela Diretiva da Comunidade Europeia 2012/19/UE relativa aos REEE (Resíduos de Equipamentos Elétricos e Eletrônicos) e indica que o seu aparelho não deve ser descartado juntamente com o lixo urbano. Será recolhido seletivamente para fins de reutilização, reciclagem ou transformação. Quaisquer substâncias potencialmente nocivas para o meio ambiente que contenham devem ser eliminadas ou neutralizadas. Solicite mais informações sobre os procedimentos de reciclagem ao seu distribuidor.

AQUA  
SPHERE

# AQUASPHERE OMVORMERREGELAAR

NL - GEBRUIKSAANWIJZING



INHOUD

1. BELANGRIJKE VEILIGHEIDSINSTRUCTIES .....102

2. TECHNISCHE GEGEVENS .....105

3. VÓÓR DE INSTALLATIE .....106

4. AANSLUITING OP ZWEMBADPOMP .....106

5. INSTELLINGEN & BEDIENING .....111

6. BESCHERMING & FOUTCODES .....115

7. UITSLUITINGEN .....116

8. VERWIJDERING .....116

VEILIGHEIDSSYMBOLLEN

	Lees de handleiding en bewaar deze op een veilige plaats
	Waarschuwing
	Opgelet: Risico op elektrische schokken
	Raak het koellichaam niet aan
	E-afval: Breng naar een recyclingcentrum



## 2. BELANGRIJKE VEILIGHEIDSINSTRUCTIES



### BELANGRIJKE INFORMATIE OVER VEILIGHEID, INSTALLATIE EN ONDERHOUD

*De volledige handleiding kan als PDF-bestand worden gelezen en gedownload van de website [www.aquaspheremanuals.com](http://www.aquaspheremanuals.com)*



Om optimaal gebruik te maken van dit energiebesparende apparaat en om mogelijk risico op brand, elektrische schokken, ernstig letsel voor personen of schade aan eigendommen te voorkomen, dient u deze gebruikershandleiding zorgvuldig door te lezen voordat u het apparaat installeert en dient u deze te bewaren voor toekomstig gebruik.

- Alle montage-, elektrische installatie- en onderhoudswerkzaamheden moeten worden uitgevoerd door gekwalificeerd, bevoegd personeel dat de installatie- en onderhoudsinstructies zorgvuldig heeft gelezen.
- Dit apparaat mag niet worden gebruikt door personen (of kinderen) met beperkte lichamelijke, zintuiglijke of geestelijke capaciteiten of met gebrek aan ervaring en kennis, tenzij zij onder toezicht staan van een persoon die verantwoordelijk is voor hun veiligheid of nadat zij de nodige opleiding hebben genoten over het gebruik van het apparaat.
- Kinderen moeten onder toezicht staan om ervoor te zorgen dat ze niet met het apparaat spelen.
- Het apparaat mag worden gebruikt door kinderen vanaf 8 jaar en door personen met verminderde lichamelijke, zintuiglijke of geestelijke vermogens of met gebrek aan ervaring en kennis, als zij onder toezicht staan of instructies hebben gekregen over het veilige gebruik van het apparaat en begrijpen welke gevaren eraan verbonden zijn.
- Laat kinderen niet met het apparaat spelen.
- Reiniging en gebruikersonderhoud mogen niet door kinderen zonder toezicht worden uitgevoerd.
- Onze producten mogen alleen worden gemonteerd en geïnstalleerd in zwembaden die voldoen aan de normen IEC/HD 60364-7-702 en de toepasselijke nationale regelgeving. De installatie moet voldoen aan de norm IEC/HD 60364-7-702 en de toepasselijke nationale regelgeving voor zwembaden.



Uw laatselijke handelaar kan u verdere informatie verstrekken.

- De omvormerregelaar kan niet in Zone 0 (Z0) of Zone 1 (Z1) worden geïnstalleerd. Zie pagina 2 voor tekeningen

Het apparaat moet worden aangesloten op een wisselstroomvoeding met aardverbinding (zie de gegevens op het typeplaatje van de omvormerregelaar), beschermd door een aardlekschakelaar met een nominale reststroom van maximaal 30 mA.

- De vaste elektrische installatie moet uitgerust zijn met een lastscheider, in overeenstemming met de installatievoorschriften.

- Er kan slechts ÉÉN pomp op de omvormer worden aangesloten. Sluit geen andere apparaten aan op de uitgang.

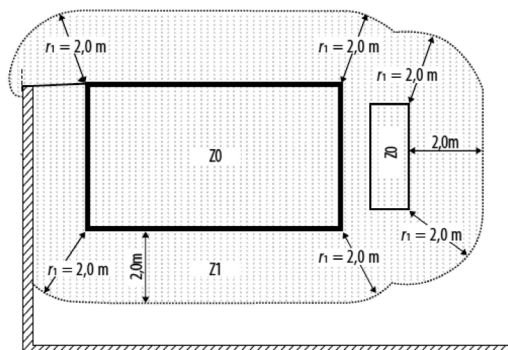
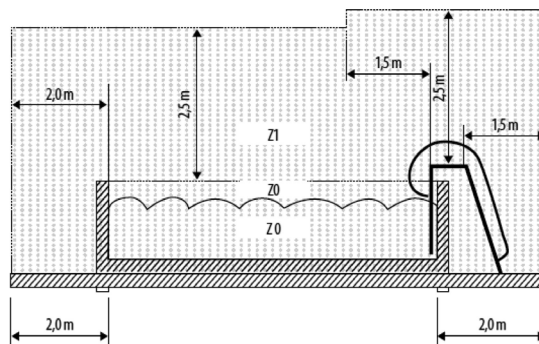
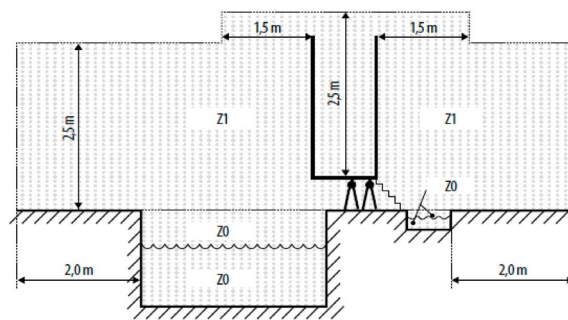



Dit apparaat kan ALLEEN gebruikt worden met zwembadpompen met een motor met permanent gescheiden condensator. Het onderstaande schema toont een typische zwembadpomp motor met één snelheid.

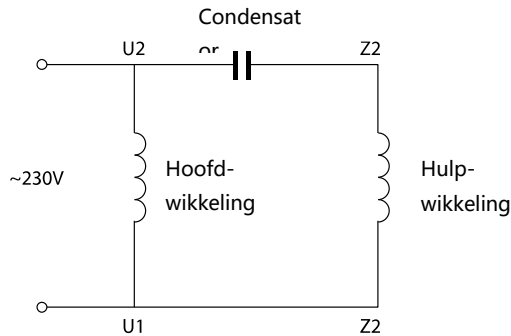

Fig.1

1.1 Dit product is NIET compatibel met:

- a. Eén- (drie-) fasige motoren met centrifugaalschakelaar.
- b. Zwembadpomp motoren met startrelais of schakelaar.
- c. Serie- of gelijkstroom motoren.
- d. Zwembadpomp motoren met defecte rotoren of condensatoren.
- e. Asynchrone motoren met gearceerde polen.

1.2 In combinatie met dit product moet een aardlekschakelaar met een nominale reststroom van maximaal 30 mA worden gebruikt.



Als u niet zeker weet of uw zwembadpomp compatibel is met dit apparaat, neem dan contact op met uw leverancier of fabrikant voordat u verder gaat met de installatie.

## 2. TECHNISCHE GEGEVENS

### 2.1 Aquasphere omvormerregelaar 1,1 kW

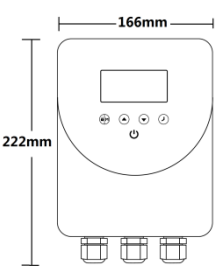
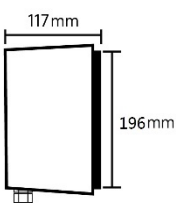
Model	75947	Afmetingen
Ingangsvermogen	1 fase AC	
Ingangsvoltage	220-240 V	
Ingangsfrequentie	50 Hz	
Uitgangsvermogen	Max 1,1 kW	
Uitgangsvoltage	1 fase, 0-240V	
Pomptype	Eenfasig	
Max. stroomsterkte	Max. 6 A	
Snelheidsbereik	1200~2900 rpm	
Koeling	Ventilatie	
Netto afmetingen (L*H*B)	222*117*166 mm	

### 3. VÓÓR DE INSTALLATIE



Controleer bij ontvangst van dit apparaat op schade aan de verpakking of het product.

Ga NIET door met de installatie als u schade aantreft; neem contact op met uw leverancier.

Gebruik geen verlengsnoeren met het apparaat. Dit kan gevaarlijk zijn, vooral in de buurt van een zwembad.

Zorg ervoor dat de plaats die u kiest voor de installatie aan de volgende voorwaarden voldoet:

- Omgevingstemperatuur van -10 tot 40 °C
- 45 tot 90 procent relatieve vochtigheid, niet-condenserend
- Minder dan 1000 m boven de zeespiegel
- Uit direct zonlicht houden
- Goede ventilatie

Voor een efficiënte koeling moet u ervoor zorgen dat het apparaat met een minimale vrije ruimte eromheen wordt geïnstalleerd (Fig.2).

Geblokkeerde ventilatie of een afgesloten ruimte met beperkte luchtstroming kan leiden tot oververhitting of mogelijk falen van de omvormer.

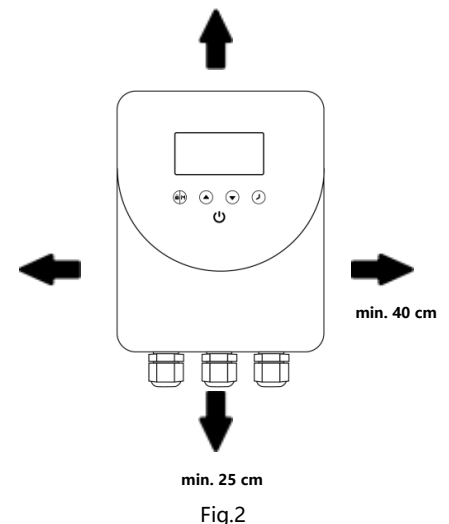

### 4. AANSLUITING OP ZWEMBADPOMP



Volg deze stappen en het bedradingschema voor een correcte aansluiting. De garantie kan komen te vervallen als het apparaat niet wordt geïnstalleerd volgens de instructies in deze handleiding.

Er kan slechts ÉÉN pomp op de omvormer worden aangesloten. Sluit geen andere apparaten aan op de uitgang.

Markeer de locaties van de gaten op de muur, boor deze, plaats de meegeleverde expansiepluggen, breng de schroeven aan en hang het apparaat aan de schroeven.

4.1 Schakel alle elektrische voeding naar de zwembadpomp uit, haal de stekker uit de hoofdschakelaar of uit de chlorinator die de pomp van stroom voorziet.

4.2 Steek de stekker van de zwembadpomp in het stopcontact van het apparaat (met de aanduiding PUMP CONNECTION ONLY).

Het wordt aanbevolen dat de totale lengte van de uitgangskabel van de apparatuur en de voedingskabel van de zwembadpomp niet meer dan 2m bedraagt.

4.3 Sluit het apparaat aan op de hoofdschakelaar/chlorinator/timeraansluiting waar de pomp oorspronkelijk op aangesloten was.

4.4 Om de invloed van elektromagnetische interferentie te verminderen, dient u de aardingsdraad, die op het koellichaam is bevestigd, aan te sluiten op de motor van de zwembadpomp (als de uitgang van de frequentieomvormer geen stekker heeft, hoeft deze niet aangesloten te worden).

4.5 Schakel alle stroom weer in.

4.6 Controleer of de chlorinator/timer actief is.

4.7 Nu is het apparaat klaar voor gebruik

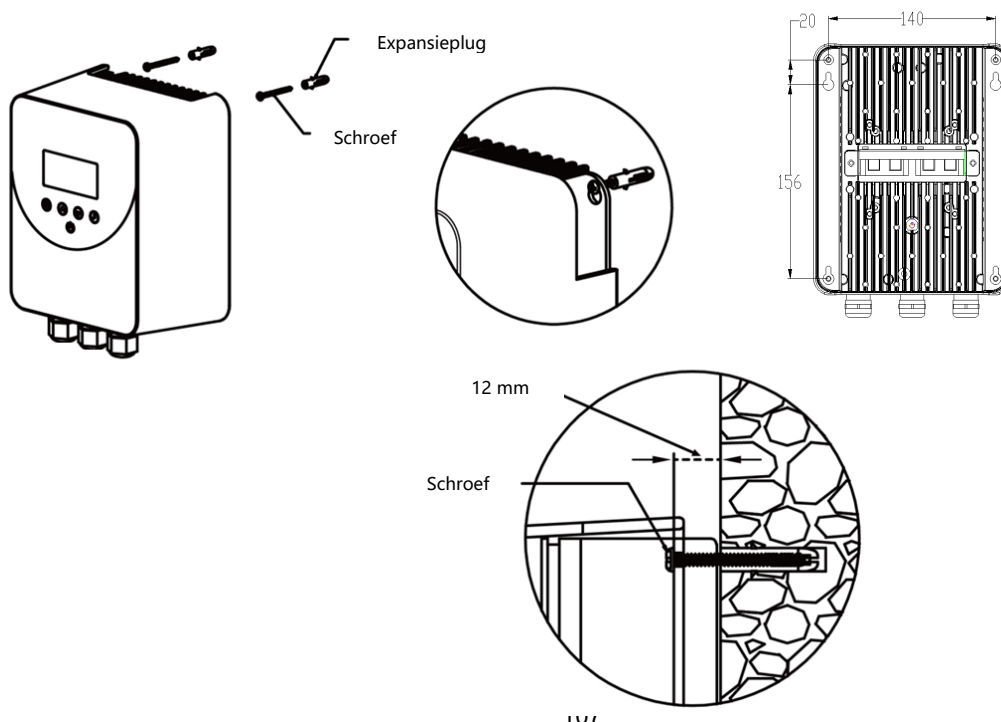

Fig.3

Bovenstaande afbeelding is alleen ter referentie, de stekker en het stopcontact kunnen per land/regio verschillen.

Als het stopcontact voor de pomp al in uw apparaat aanwezig is, bedraad het apparaat dan zoals in Fig.4 en 5 wordt getoond.

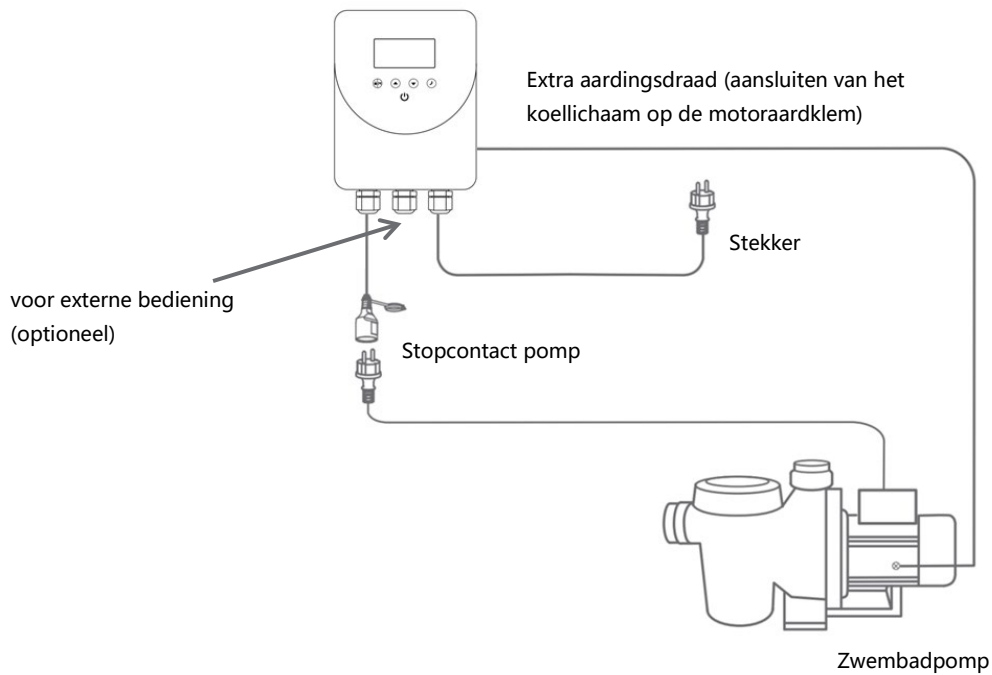

Fig.4

Bovenstaande afbeelding is alleen ter referentie, stekkers en stopcontacten kunnen per land/regio verschillen.

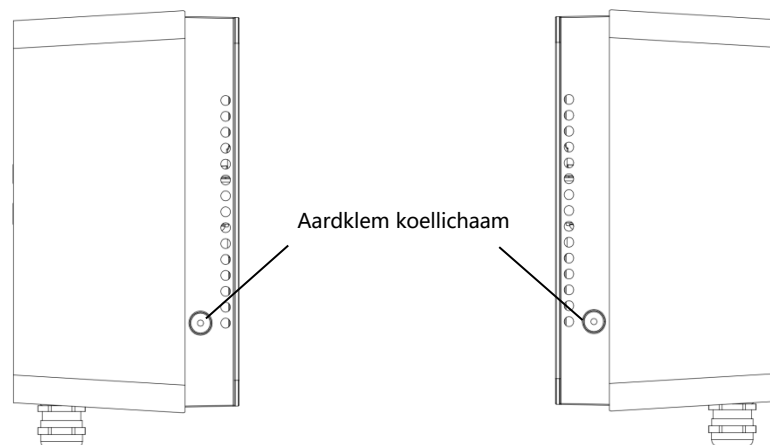

Fig.5 Aansluitschema aardingsdraad

Als de pompaansluiting niet bij uw apparaat is inbegrepen, bedraad het apparaat dan zoals weergegeven in Fig.6 en 7

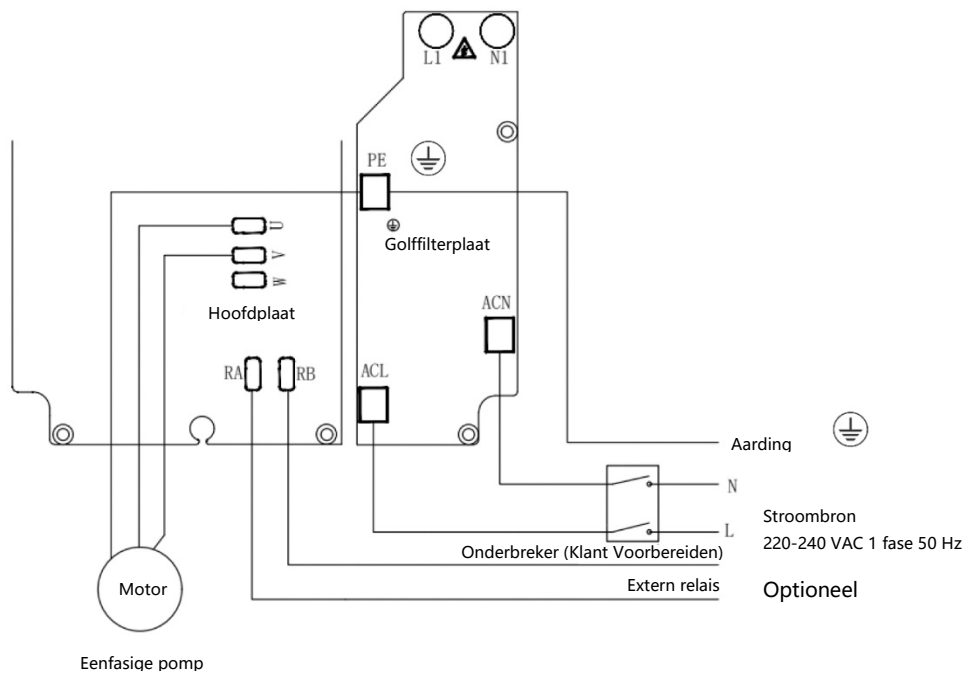
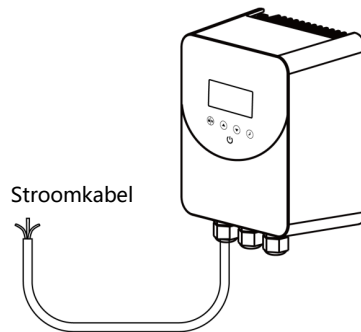
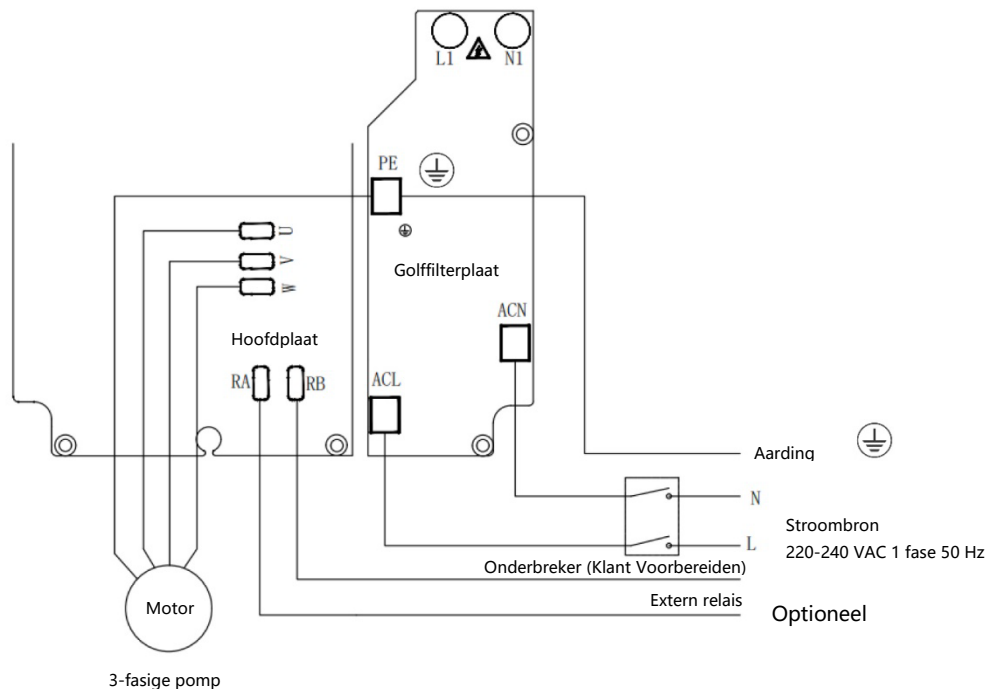

Fig 6 1-fase aansluitdiagram pomp



Raak het koellichaam niet aan terwijl het apparaat in werking is of tot minstens 30 minuten nadat het is uitgeschakeld. Houd het buiten het bereik van kinderen.



Probeer geen onderdelen te demonteren of te vervangen in geval van storingen of defecten, omdat het apparaat hoogspanningsomzettingcomponenten bevat. Voordat u reparaties aan het apparaat uitvoert, moet u wachten tot het aan/uit-lampje uit is of minstens 3 minuten nadat u de stekker uit het stopcontact hebt getrokken.



Voor een 3-fasige omvormerregelaar sluit u de pompmotor aan met een driehoekschakeling.



## 5. INSTELLINGEN & BEDIENING



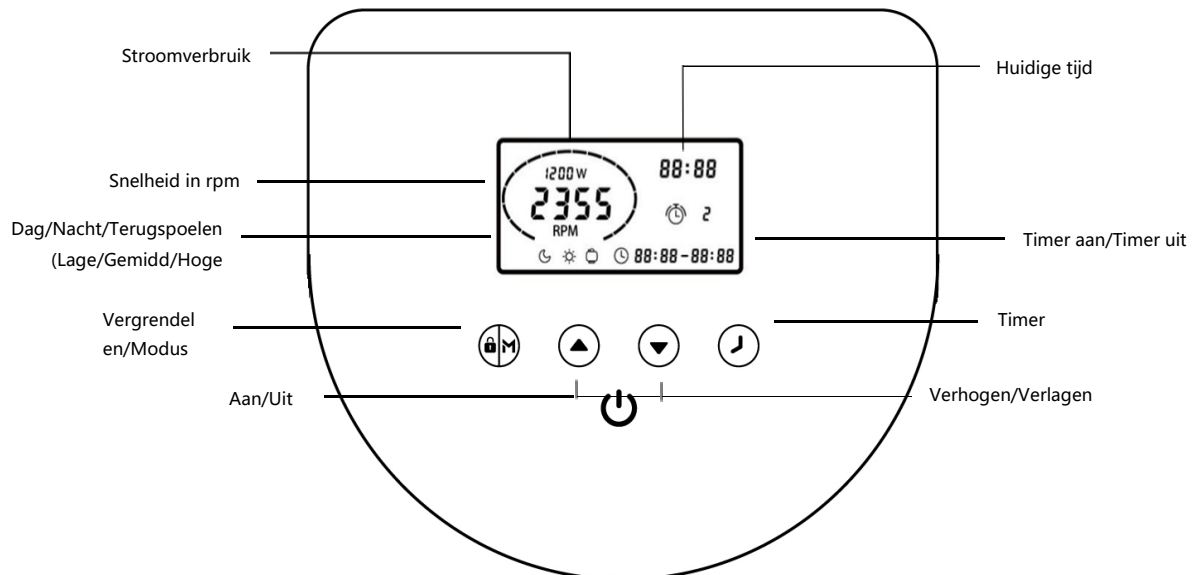



### 5.1 Bedieningspaneel



### 5.2 Modusselectie

De frequentieomvormer heeft 3 modi (snelheidsbereiken). U kunt uw pomp op een constante snelheid laten draaien, waarbij u kunt kiezen uit "M", of u kunt tot 4 timers instellen voor dagelijks gebruik, elk met een eigen snelheid.

Modus	Snelheidsbereik	Standardsnelheid
Nacht (Laag)	1200~ 1650 rpm	1400 rpm
Dag (gemiddeld)	1700~2400 rpm	2000 rpm
Terugspoelen (Hoog)	2450~2900 rpm	2900 rpm

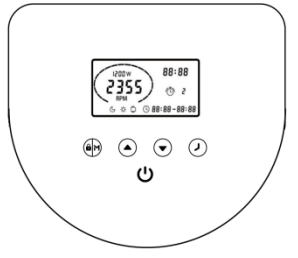
<p>① Wanneer aangesloten, licht  op, houd  3 seconden ingedrukt om het scherm te ontgrendelen. Druk op  om te beginnen.</p> <p>② Na het starten draait de pomp gedurende één minuut aan een maximale snelheid van 2900 rpm voor zelfaanzuiging. (Dit kan worden verhoogd tot 10 minuten - zie Parameterinstellingen Sectie 5.5)</p> <p>③ Druk op  om een bedrijfssnelheid te kiezen, gebruik de  of  pijlen om de snelheid indien nodig in stappen van 50 rpm aan te passen tot een specifieke bedrijfssnelheid.</p>	
--	---







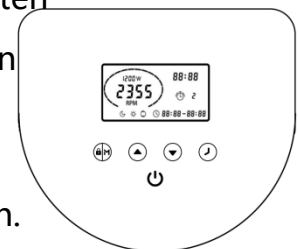

Zodra de pomp klaar is met aanzuigen, schakelt de omvormer de pomp automatisch naar de vooraf ingestelde snelheid.  geeft aan dat de pomp draait en toont het huidige toerental en stroomverbruik.

### 5.3 Timerinstelling

Om de pomp op verschillende tijden of snelheden te laten draaien om te profiteren van lagere elektriciteitsstarieven tijdens de nacht, kunt u tot 4 timers instellen.





Stap 1 : Druk op  om naar de timerinstellingen te gaan.

Stap 2 : Gebruik  of  om de huidige tijd in te stellen. Druk op  om de cursor naar de volgende instelling te brengen. Druk op  om een snelheidsbereik te kiezen voor timer 1, gebruik  of  voor een specifieke snelheid indien vereist. Druk op   om de cursor naar de volgende instelling te brengen.

Stap3: Herhaal bovenstaande stappen om de anderre 3 timers in te stellen.

Stap 4: Houd  gedurende 3 seconden ingedrukt, of wacht 10 seconden om de instellingen automatisch op te slaan.

Een knipperende  **88:88 - 88:88** geeft aan dat het apparaat op starttijd wacht.



Stap 5: Druk op  of  om alle vier timers te controleren om er zeker van te zijn dat er geen ongeldige instellingen zijn.

Alle overlappende timerperioden worden als ongeldig beschouwd en het apparaat zal alleen werken op basis van de vorige geldige timerinstelling. Om de timerinstellingen te verlaten, houdt u  ingedrukt gedurende 3 seconden.

Opmerking:

\* Als het scherm gedurende 1 minuut niet actief is, wordt het automatisch vergrendeld. Houd  3 seconden ingedrukt om het apparaat te ontgrendelen.

\* Het apparaat heeft een uitschakelgeheugen, de werking wordt hervat zodra de stroom wordt hersteld.

Houd in UIT-modus   3 seconden ingedrukt om de fabrieksinstellingen terug te zetten.

## 5.4 Externe bediening (optioneel)

Via de volgende contacten kan externe bediening worden ingeschakeld. Maar zelfs als het via een externe controller werkt, kan u het apparaat stoppen  of op te drukken.

Zet geen spanning op deze ingangen.

PIN	Draadkleur	Signaalbeschrijving
1	ROOD	Digitale ingang 4
2	ZWART	Digitale ingang 3
3	WIT	Digitale ingang 2
4	GRIJS	Digitale ingang 1
5	GEEL	DGND
6	GROEN	RS485-A
7	BRUIN	RS485-B

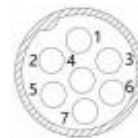

Fig. 8

Bijv.: Om externe snelheidsregeling via een digitale ingang mogelijk te maken, sluit u één van de cijfers van PIN 1/2/3 aan op COM.



Als PIN4 verbonden is met Com, zal de pomp stoppen; als de verbinding verbroken wordt, zal de digitale besturing ongeldig zijn;

Als PIN3 verbonden is met Com, draait de pomp op 2900 rpm; als de verbinding verbroken wordt, ligt de prioriteit van de besturing weer bij de paneelbesturing;

Als PIN2 verbonden is met Com, draait de pomp op 2400 rpm; als de verbinding verbroken wordt, ligt de prioriteit van de besturing weer bij de paneelbesturing;

Als PIN1 verbonden is met Com, draait de pomp op 1200 rpm; als de verbinding verbroken wordt, ligt de prioriteit van de besturing weer bij de paneelbesturing;

## 5.5 Parameters instellen

Houd in UIT-modus   3 seconden ingedrukt om naar de parameterinstellingen te gaan.

Parameter	Beschrijving	Standaardinstelling	Instellingsbereik
1	Aanzuigtijd	1 minuten	0~10 min, in stappen van 1 minuut
2	Minimum RPM	1200 rpm	1200~2000 rpm, in stappen van 100 rpm
3	PIN3	2900 rpm	1200~2900 rpm, in stappen van 100 rpm
4	PIN2	2400 rpm	1200~2900 rpm, in stappen van 100 rpm
5	PIN1	1200rpm	1200~2900 rpm, in stappen van 100 rpm
6	Snelheid zelfaanzuiging	2900 rpm	1200~2900 rpm, in stappen van 100 rpm

## 6. BESCHERMING & FOUTCODES

Item	Code	Beschrijving	Analyse
1	E001	Abnormale ingangsspanning	Niet foutief
2	E002	Te hoge uitgangsstroom	Niet foutief
3	E101	Koellichaam oververhit	Contacteer uw leverancier
4	E102	Fout in koellichaamsensor	Contacteer uw leverancier
5	E103	Fout in hoofdbesturingsbord	Contacteer uw leverancier
6	E201	Fout in printplaat	Contacteer uw leverancier
7	E202	Leesfout EEPROM moederbord	Contacteer uw leverancier
8	E203	Leesfout real time klok	Contacteer uw leverancier
9	E204	Leesfout EEPROM toetsenbord	Contacteer uw leverancier
10	E205	Communicatiefout	Contacteer uw leverancier
11	AL01	Automatische snelheidsreductie tegen hoge temperatuur	Contacteer uw leverancier

### *Opmerking:*

1. AL01 is geen foutmelding: als dit verschijnt, schakelt de omvormer automatisch naar een lagere snelheid om zichzelf te beschermen tegen een te hoge interne temperatuur. Als de temperatuur weer tot 68 °C daalt, gaat de omvormer weer verder op de vooraf ingestelde snelheid.

2. Wanneer de oorzaken voor E002/E101/E103 verdwijnen, zal het apparaat automatisch weer gaan werken, maar wanneer dit voor de vierde keer verschijnt, zal het apparaat stoppen met werken; om de werking te hervatten, haalt u de stekker uit het stopcontact en sluit u het apparaat weer aan en start u het opnieuw op.

## 7. UITSLUITINGEN

Onder geen enkele omstandigheid kan de fabrikant aansprakelijk worden gesteld voor eventuele gevolgen die voortvloeien uit een ongepaste, onjuiste installatie of het verkeerd afstellen van het product op zwembadpompen die niet compatibel zijn.

De fabrikant behoudt zich het recht voor om de specificatie van het product of de prestaties of de inhoud van de gebruikershandleiding zonder voorafgaande kennisgeving te wijzigen in geval van een technische upgrade.

## 8. VERWIJDERING



Dit symbool is verplicht volgens de Europese richtlijn 2012/19/EU betreffende AEEA (afgedankte elektrische en elektronische apparatuur) en betekent dat dit apparaat niet met het gewone huisvuil mag worden verwijderd. Het wordt selectief verzameld met als doel hergebruik, recycling of transformatie. Alle potentieel voor het milieu gevaarlijke stoffen die het kan bevatten worden geëlimineerd of geneutraliseerd. Vraag uw winkelier om informatie over recyclingprocedures.