

Z200 Defrost
Z200
PI20 Defrost
PI20

Instructions for installation and use - English
Heat pump
Translation of the original instructions in French

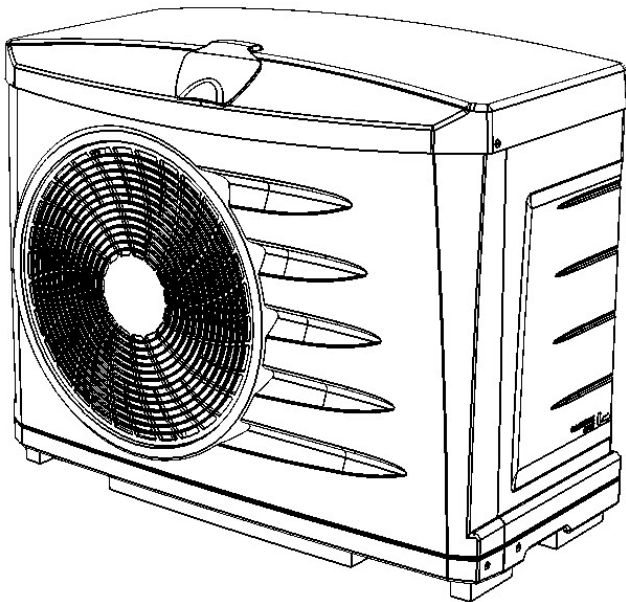



EN

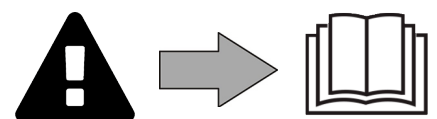

More documents on:
www.zodiac.com



⚠ WARNINGS



	This symbol shows that information is available such as the Operating Manual or Installation Manual.		This symbol shows that this appliance uses R32, a low burning velocity refrigerant.
	This symbol shows that the Operation Manual should be read carefully.		This symbol shows that a service personnel should be handling this equipment with reference to the Installation Manual.

- Before handling the appliance, it is vital that you read this installation and user manual, as well as the “Warranties” booklet delivered with the appliance. Failure to do so may result in material damage or serious or fatal injury and will void the warranty.
- Keep and pass on these documents for reference during the appliance’s service life.
- The distribution or modification of this document in any way is prohibited, without prior authorisation from the manufacturer.

EN

The manufacturer is constantly developing its products to improve their quality. The information contained herein may therefore be modified without notice.

GENERAL WARNINGS

- Failure to respect the warnings may cause serious damage to the pool equipment or cause serious injury, even death.
- Only a person qualified in the technical fields concerned (electricity, hydraulics or refrigeration) is authorised to perform any servicing or repairs to the appliance. The qualified technician working on the appliance must use/wear personal protective equipment (such as safety goggles and protective gloves, etc.) in order to reduce the risk of injury occurring when working on the appliance.  
- Before handling the machine, ensure that the power is switched off and isolated from the power supply.
- The appliance is intended to be used for pools and spas for a specific purpose; it must not be used for any purpose other than that for which it was designed.
- This appliance is not intended for use by individuals (including children) with impaired physical, sensorial or mental abilities, or persons lacking in knowledge and experience, unless they receive supervision or prior instructions on using the appliance from a person responsible for their safety. Children must be supervised to ensure that they do not play with the appliance.
- This appliance can be used by children over 8 and adults with impaired physical, sensory or mental capabilities, or who lack experience and knowledge, if they are correctly supervised or have been instructed in how to use the appliance safely and understand the hazards involved. This appliance should not be cleaned or maintained by children without supervision.
- The appliance must be installed according to the manufacturer’s instructions and in compliance with local standards. The installer is responsible for installing the appliance and for compliance with national installation regulations. Under no circumstances may the manufacturer be held liable in the event of failure to comply with applicable local installation standards.
- For any work other than the simple user maintenance described in this manual, the product should be referred to a qualified professional.
- If the appliance suffers a malfunction, do not try to repair it yourself; instead contact a qualified technician.
- Refer to the warranty conditions for details of the permitted water balance values for operating the appliance.
- Deactivating, eliminating or by-passing any of the safety mechanisms integrated into the appliance shall automatically void the warranty, in addition to the use of spare parts manufactured by unauthorised third-party manufacturers.
- Do not spray insecticide or any other chemical (flammable or non-flammable) in the direction of the appliance, as this may damage the body and cause a fire.

- Do not touch the fan or moving parts and do not place any objects or your fingers in the vicinity of the moving parts during operation of the appliance. Moving parts can cause serious injury or even death.

WARNINGS ASSOCIATED WITH ELECTRICAL APPLIANCES

- The electrical supply to the appliance must be protected by a 30 mA differential Residual Current protection Device (RCD), complying with the standards and regulations in force in the country in which it is installed.
- Do not use any extension lead when connecting the appliance; connect the appliance directly to a suitable power supply circuit.
- Before carrying out any operations, check that:
 - The voltage indicated on the appliance information plate corresponds to the mains voltage.
 - The power grid is adapted to the power requirements of the appliance, and is grounded.
- In the event of anormal operation or the release of unusual odours from the appliance, turn it off immediately, unplug it from its power supply and contact a professional.
- Before any access to the appliance for service or maintenance, ensure that it is switched off and completely disconnected from the power supply. Furthermore, in addition to confirming that the heating priority (where applicable) is deactivated, ensure that any other equipment or accessories connected to the appliance are also disconnected from the power supply circuit.
- Do not disconnect and reconnect the appliance to the power supply when in operation.
- Do not pull on the power cord to disconnect it from the power supply.
- If the power cord is damaged, it must be replaced by the manufacturer, its technician or a qualified person to guarantee safety.
- Do not perform maintenance or servicing operations on the appliance with wet hands or if the appliance is wet.
- Before connecting the appliance to the source of supply, ensure that the terminal block or supply socket to which the appliance will be connected is in good condition and is not damaged or corroded in any way.
- For any component or sub-assembly containing a battery: do not recharge or dismantle the battery, or throw it into a fire. Do not expose it to high temperatures or direct sunlight.
- In stormy weather, disconnect the appliance from the power supply to prevent it from suffering lightning damage.
- Do not immerse the appliance in water (with the exception of cleaners) or mud.

WARNINGS CONCERNING APPLIANCES CONTAINING R32 REFRIGERANT

- This device contains R32 refrigerant, a class A2L refrigerant, which is considered to be potentially flammable.
- Do not discharge R32 fluid into the atmosphere. These are fluorinated greenhouse effect gases, covered by the Kyoto Protocol, with a Global Warming Potential (GWP) = 675 (EU Regulation No. 517/2014).
- In order to comply with relevant environmental and installations standards and regulations such as, but not limited to, French decree No. 2015-1790 and/or the EU Regulation EU 517/2014, the cooling circuit must be checked for leakage at least once a year. This operation must be carried out by a certified cooling appliance specialist.
- The device must be stored in a ventilated place away from all sources of fire.
- Install the unit outdoors. Do not install the unit indoors or in an enclosed, non-ventilated area outdoors.
- Do not use means to accelerate the defrosting process or to clean, other than those recommended by the manufacturer.
- The appliance shall be stored in a room without continuously operating ignition sources (for example: open flames, an operating gas appliance or an operating electric heater).
- Do not pierce or burn.
- Be aware that R32 refrigerants may not contain an odour.

INSTALLATION AND MAINTENANCE

- The appliance may not be installed close to combustible materials, or an air duct inlet of an adjacent building.
- With some appliances, it is essential to fit protection grids if the unit is installed in an area with uncontrolled access.
- During installation, troubleshooting and maintenance, pipes may not be used as steps: the pipe could break under the weight, spilling coolant and possibly causing serious burns.
- When servicing the appliance, the composition and state of the heat transfer fluid must be checked, as well as the absence of any traces of coolant.
- During the appliance's annual sealing test in accordance with applicable legislation, the high and low pressure switches must be checked to ensure that they are securely fastened to the cooling circuit and that they cut off the electrical circuit when tripped.
- During maintenance work, ensure there are no traces of corrosion or oil around the cooling components.
- Before beginning work on the cooling circuit, stop the appliance and wait for a few minutes before fitting the temperature and pressure sensors. Some elements such as the compressor and piping may reach temperatures in excess of 100°C and high pressures with the consequent risk of severe burns.

LABELLING

- Equipment shall be labelled stating that it has been decommissioned and emptied of refrigerant.
- The label shall be dated and signed.
- For appliances containing flammable refrigerants, ensure that there are labels on the equipment stating the equipment contains flammable refrigerant.

RECOVERING





- When removing refrigerant from a system. either for servicing or decommissioning, it is recommended good practice that all refrigerants are removed safely.
- When transferring refrigerant into cylinders, ensure that only appropriate refrigerant recovery cylinders are employed. Ensure that the correct number of cylinders for holding the total system charge is available. All cylinders to be used are designated for the recovered refrigerant and labelled for that refrigerant (i.e. special cylinders for the recovery of refrigerant). Cylinders shall be complete with pressure-relief valve and associated shut-off valves in good working order. Empty recovery cylinders are evacuated and, if possible, cooled before recovery occurs.
- The recovery equipment shall be in good working order with a set of instructions concerning the equipment that is at hand and shall be suitable for the recovery of all appropriate refrigerants including, when applicable, flammable refrigerants. In addition, a set of calibrated weighing scales shall be available and in good working order. Hoses shall be complete with leak-free disconnect couplings and in good condition. Before using the recovery machine, check that it is in satisfactory working order, has been properly maintained and that any associated electrical components are sealed to prevent ignition in the event of a refrigerant release. Consult manufacturer if in doubt.
- The recovered refrigerant shall be returned to the refrigerant supplier in the correct recovery cylinder, and the relevant waste transfer note arranged. Do not mix refrigerants in recovery units and especially not in cylinders.
- If compressors or compressor oils are to be removed, ensure that they have been evacuated to an acceptable level to make certain that flammable refrigerant does not remain within the lubricant. The evacuation process shall be carried out prior to returning the compressor to the suppliers. Only electric heating to the compressor body shall be employed to accelerate this process. When all is drained from a system, it shall be carried out safely.



RECYCLING

This symbol is required by the European directive DEEE 2012/19/EU (directive on waste electrical and electronic equipment) and means that your appliance must not be thrown into a normal bin. It will be selectively collected for the purpose of reuse, recycling or transformation. Any substances it may contain which are potentially dangerous to the environment shall be eliminated or neutralised. Request information on recycling procedures from your retailer.

CONTENTS

	1 Specifications	5
1.1	Description	5
1.2	Technical specifications	6
1.3	Dimensions and marking	7
	2 Installation	8
2.1	Selecting the location	8
2.2	Hydraulic connections	9
2.3	Electricity supply connections	10
2.4	Option connection	11
	3 Use	12
3.1	Operating principle	12
3.2	User interface presentation	12
3.3	Operating	13
3.4	User functions	14
	4 Maintenance	15
4.1	Winterizing	15
4.2	Maintenance	15
	5 Troubleshooting	18
5.1	Device behaviour	18
5.2	Error code display	19
5.3	Wiring diagrams	20



Tip: to make it easier to contact your reseller

- Write down your reseller's contact details to help you find them more easily and fill in the "product" information on the back of the manual; your reseller will ask you for this information.



1 Specifications

1.1 | Description

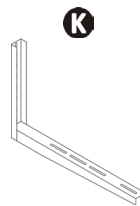
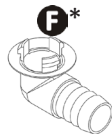
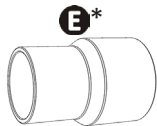
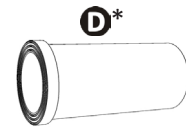
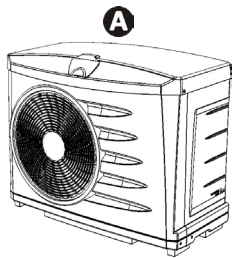

EN

*In the polystyrene cap above the heat pump

A		Z200	PI20
B	Joint (x2)	✓	✓
C	Screw-in connector (x2)	✓	✓
D	Ø40 adaptation (x2)	✓	✓
E	Ø50 reduction (x2)	✓	✓
F	Condensation evacuation kit (Ø15)	✓	✓
G	Winterizing cap (x2)	✓	✓
H	Winterizing cover	✓	✓
	Heating priority	✓	✓
I	Remote control	+	+
J	PAC NET (cleaning product)	+	+
K	Wall mounting kit	+	+

✓: supplied

+: available as an accessory

➤ 1.2 I Technical specifications

		Standards				Defrost			
Z200		M2	M3	M4	M5	MD2	MD3	MD4	MD5
PI20		PI2021	PI2031	PI2041	PI2051	PI2021D	PI2031D	PI2041D	PI2051D
Operating temperature range	air	5 to 32°C				- 5 to 32°C			
	water	up to 32°C							
Operating power*	kW	4.8	7	8.1	10.1	4.8	7	8.1	10.1
Power supply		220-240 V / 50Hz							
Defrosting by forced air circulation		X	X	X	X				
Defrosting by cycle inversion						X	X	X	X
Acceptable variation in voltage		-10%, +7% (during operation)							
Nominal absorbed intensity	A	4.5	6.3	7.9	11.2	4.5	6.3	7.9	11.2
Maximum absorbed intensity	A	5.2	7.6	10.2	13.4	5.2	7.6	10.2	13.4
Minimum cable section**	mm ²	3x2,5							
		3G2,5							
Proof pressure	bar	6							
Service pressure	bar	1.5							
Max. Discharge/Suction Pressure	bar	42/1.2							
Max. high-pressure/low pressure side pressure	bar	42/1.2							
Head loss	mCE	1	1.5		1		1.5		
Minimum optimum water flow rate	m ³ /h	4							
Maximum water flow	m ³ /h	10							
Refrigerant type		R32							
Refrigerant charge	kg	0.68	0.8	0.9	1.1	0.68	0.8	0.9	1.1
Weight	kg	35	40	46	51	39	42	47	52

The appliances have an Ingress Protection (IP) rating of IPX4 or better. Please refer to the marking indicating the IP-rating on your particular product.

* Performance: air 15 °C / water 26 °C / humid. 70%.

** Values provided for information purposes for a maximum length of 20 metres (calculation base: NFC15-100), must be checked and adapted to the installation conditions and standards of the installation country.

➤ 1.3 I Dimensions and marking

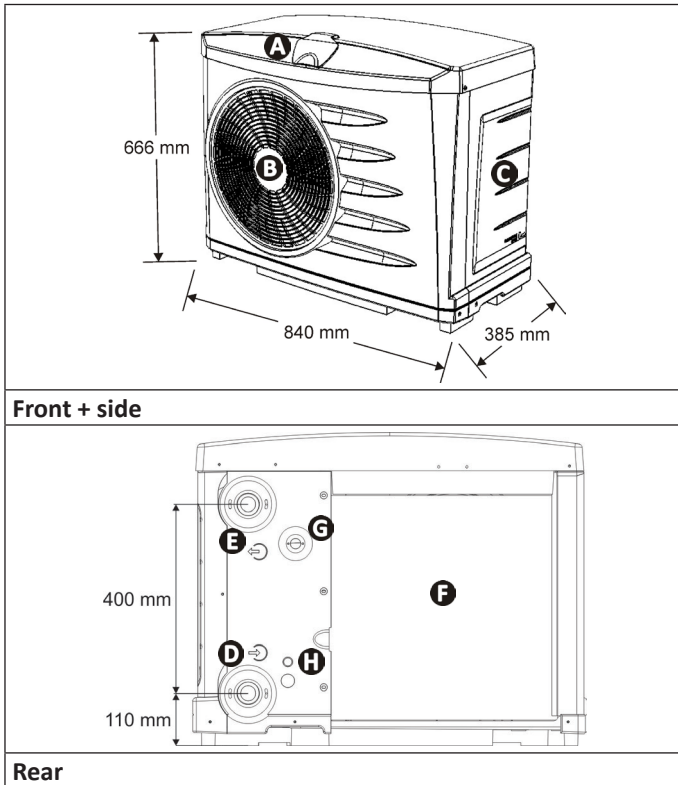

- A**: Protection valve and user interface
 - B**: Ventilator
 - C**: Technical access door
 - D**: Pool water intake
 - E**: Pool water output
 - F**: Evaporator
 - G**: Grommet for heating priority cable run*
 - H**: Location for drilling for remote control cable run*
- *depending on the model

EN



2 Installation

2.1 I Selecting the location



- The appliance must be installed at 2 metres, minimum, from the surrounding edge of the pool.
- Do not lift the device by the body; use its base.

- Install the device outdoors; provide free space around it (see § “2.2 I Hydraulic connections”).
- Place the device on its anti-vibration studs (integrated under its base) on a stable, solid and level surface,
- This surface must be able to bear the weight of the device (in particular in the case of installation on a roof, a balcony or any other support).
- The device may be secured to the ground using the holes in the base of the device or with rails (not supplied). A drilling scale is available on the back of the packaging carton.

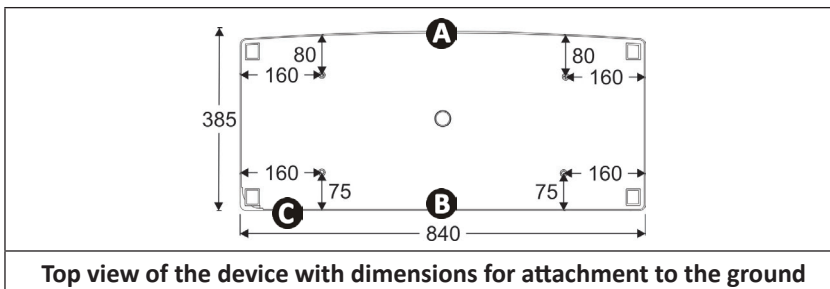

- A:** front
- B:** rear
- C:** connectors

The device must not be installed:



- In a closed and unventilated room
- In a location subject to high winds,
- With the blowing towards a permanent or temporary obstacle (window, wall, hedge, awning, etc.) less than 3 metres away,
- Within range of water or mud jets, sprays or run-off (take the effect of the wind into account),
- Near a heat source or flammable gas,
- Near high frequency equipment,
- In a location where it would be subject to snow build-up,
- In a location where it might be flooded by the condensation produced by the device when operating.

Tips: reduce any noise annoyance from your heat pump



- Do not install it under or towards a window.
- Do not tilt it towards your neighbours.
- Install it in a clear space (the sound waves are reflected on surfaces).
- Install an acoustic screen around the heat pump, respecting the distances.
- Install the anti-vibration studs under the heat pump and replace them regularly.
- Install 50cm of flexible PVC pipe at the heat pump water input and output (stops vibrations).

2.2 I Hydraulic connections

- The device will be connected with a $\varnothing 40$ or $\varnothing 50$ PVC pipe, using the connectors supplied (see § “1.1 I Description”), to the pool's filtration circuit, after the filter and before the water treatment.
- Respect the direction of hydraulic connection ( = input and  = output).
- A by-pass must be installed to make it easier to work on the device.

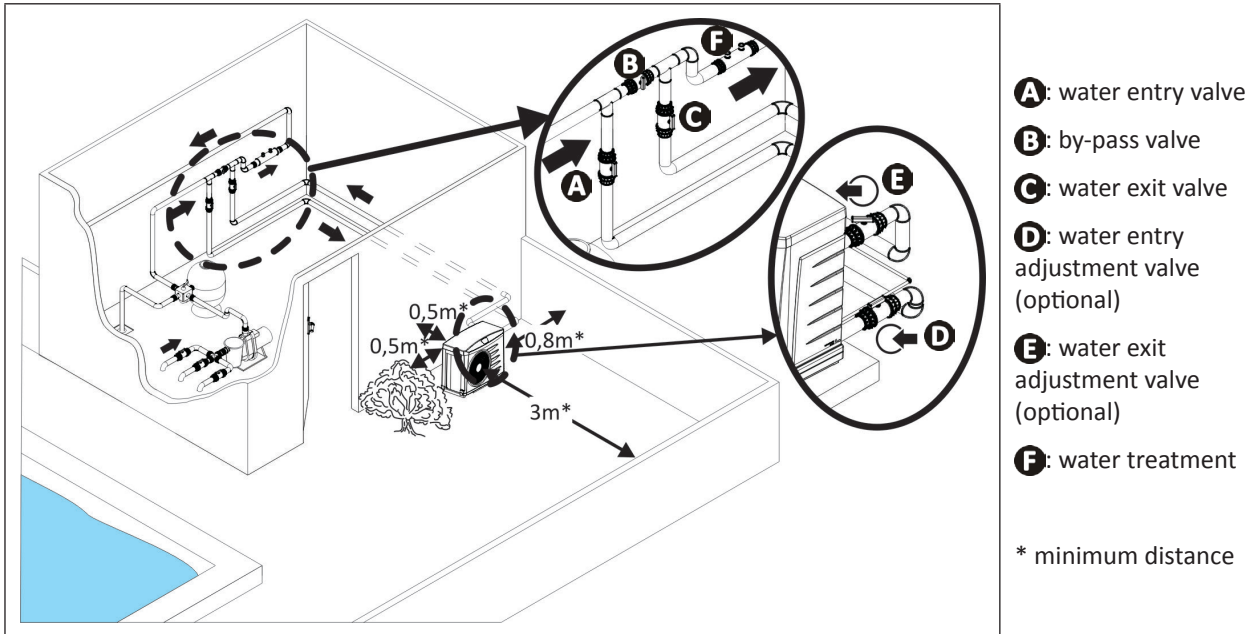

EN

- To evacuate the condensation, fit a $\varnothing 15$ pipe on the grooved elbow to be mounted under the device base (supplied according to model, see § “1.1 I Description”).



Tip: condensation drainage

Caution, several litres of water must be drained from your device each day. We strongly recommend connecting the drainage to the sewers

2.3 I Electricity supply connections



- Before any work inside the device, you must cut the electricity supply as there is a risk of electric shock which may cause material damage, serious injury or even death.
- Incorrectly tightened terminals may cause the terminal unit to heat up and invalidate the warranty.
- Only a qualified and experienced technician is authorised to carry out cabling in the equipment or to replace the supply cable.

- The heat pump's electrical supply must be provided through a protection and circuit breaking device (not supplied) complying with the standards and regulations in force in the country where it is installed,
- The device is provided for connection to a general power supply with a TT and TN.S neutral regime.
- Electrical protection: by circuit breaker (D curve) (for calibre, see § "1.2 I Technical specifications"), with a 30 mA dedicated differential circuit breaker (circuit breaker or switch) at the head of the line.
- The electricity supply must correspond to the voltage indicated on the device's information plate.
- The electricity supply cable must be insulated against any cutting or hot elements that may damage or crush it.
- The equipment must be connected to an earth socket.
- The electrical connection lines must be fixed.
- Use the gland to pass the supply cable into the device.
- Used the supply cable (RO2V type) adapted for outdoor or buried use (or run the cable into a protection duct).
- We recommend burying the cable at a depth of 50 cl (85 cm under a road or path) in an electrical duct (red ribbed).
- If this buried cable meets another cable or pipe (gas, water, etc.), there must be more than 20 cm between them.

Depending on the model, there are 2 ways to connect:



Device not equipped with a cable (Z200 and PI20)

- Connect the supply cable to the connection terminal unit inside the heat pump.

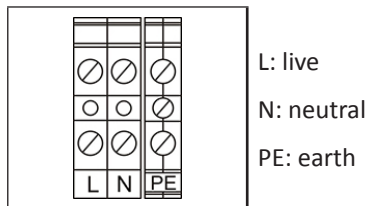

➤ 2.4 | Option connection

2.4.1 "Heating priority" option (depending on model)

- This function allows the unit to start the filtration (in 5 minutes cycle every 220 minutes) to detect the water temperature and thus switch on the filtration + heating unit to maintain this temperature at a constant value. It is said that the filtration pump is slaved to the heating system. Filtration is maintained or put into operation if the pool temperature is below the required temperature.
- For the connection, connect the filtration timer to terminals 1 and 2 and add a shunt between terminals 3 and 4.

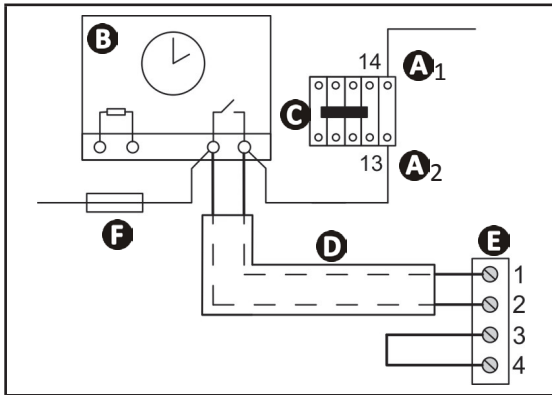

- **A**₁- **A**₂ : power for the filtration pump power contactor coil
- **B**: filtration timer
- **C**: power contactor (tripolar or bipolar) for the filtration system pump motor
- **D**: separate cable for the "heating priority" function
- **E**: heat pump terminal (see wiring diagram § "5.3 | Wiring diagrams")
- **F**: fuse

EN

- Modification of the time between 2 filtration operations (value in number of minutes):
 - press **⏻** and **SET** or **OK** at the same time for 3 seconds: **SEL** appears,
 - press **▲** until the **POI** parameter appears, then press **SET** or **OK** to change the parameter using the **▲** and **▼** keys.
 - Once the value has been modified, press **SET** or **OK** to confirm,
 - press **⏻** to exit the menu.

2.4.2 "Remote control" option (depending on model)

- This option enables the device's user interface to be duplicated to enable the device to be controlled by remote. To do so, use the remote control kit available as an accessory.
- For the connection, consult the manual supplied with the kit.



3 Use

3.1 I Operating principle

Your heat pump uses the calories (heat) in the air to heat up your pool's water. The process to heat your pool's water to the temperature you want may take a few days as it depends on the weather conditions, your heat pump's power and the difference between the water temperature and the temperature you want.

The heat pump is ideal for maintaining temperature.

The warmer and damper the air, the better your heat pump will perform. The outdoor parameters for optimum operation are an air temperature of 27°C, a water temperature of 27°C and 80% hygrometry.

Tips: improve your pool's temperature rise and maintenance



- Anticipate the commissioning of your pool far enough in advance before you use it.
- For the temperature rise, set the filtration pump to continuous operation (24/24).
- To maintain the temperature throughout the season, switch to "automatic" circulation equal to at least the water temperature divided by two (the longer this time will be, the more the heat pump will have an operating range sufficient to heat).
- Cover the basin with a sheet (bubble canopy, canvas, etc.) to prevent heat loss.
- Take advantage of a period with mild outdoor temperatures (on average > 10°C at night); your heat pump will be even more effective if it runs during the warmest hours of the day.
- Keep the evaporator clean (see § "4.2 I Maintenance").
- Set the temperature you want and let the heat pump run (adjusting the setpoint to maximum will not heat the water more quickly).
- Connect the "Heating priority"; the filtration pump and heat pump operating time will be set according to requirements.

3.2 User interface presentation

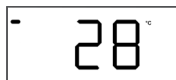

Display screen (default: setpoint temperature)



"On/off" button

SET

Pool water temperature reading or parameter setting button



Value setting buttons

Symbol	Designation	Fixed	Flashing	Off
	Water flow	Water flow ok	Water flow too low or missing	/
	Heating	Active	starting	Inactive
	Ambient air temperature	Sufficient	Insufficient	/
	Priority heating connected	Priority heating connected and heating request	Priority heating connected but no heating request	Priority heating not connected
	Fault	Fault in progress, see § "5.2 I Error code display"	Heating priority connected, heating requested but water flow too low or missing	No fault

3.3 | Operating

- Check that there are no tools or other foreign objects in the machine.
- The panel that provides access to the technical section must be put in place.
- Set the valves as follows: valve B wide open, valves A, C, D and E closed

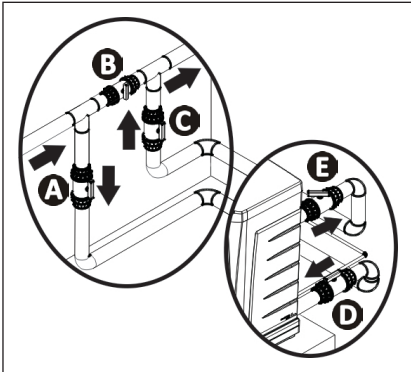

- A**: water entry valve
- B**: by-pass valve
- C**: water exit valve
- D**: water entry adjustment valve (optional)
- E**: water exit adjustment valve (optional)

EN



• An incorrect by-pass setting may cause the heat pump to malfunction.

- Check that the hydraulic corrections are correctly tightened and that there are no leaks.
- Check that the device is fully stable.
- Set the water circulation running.
- Close valve B gradually so that the filter pressure is increased by 150g (0.150 bars).
- Open valves A, C and D fully then valve E by half (the air which has built up in the heat pump condenser and the filtration circuit will bleed out). If valves D and E are not present, open valve A wide and close valve C by half.
- Connect the power supply to the heat pump:

704

program version number (different according to model)

Screen saver



Press and hold  for 2 seconds

888

Splash screen

28

Temperature setpoint

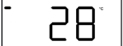
- Device starts after a timer of up to 5 minutes,
- Set the temperature you want ("setpoint" temperature) by pressing  or .
- After the steps to start up your heat pump, stop the water circulation temporarily to check that your device stops after a few seconds (by activating the flow controller):  the water flow light must flash.

Information: light water flow



➤ 3.4 I User functions

3.4.1 Water temperature reading

When the water is circulating through the heat pump, press **SET**:  flashes for 10 seconds then the setpoint temperature is displayed fixed.



- To read the water temperature, it is imperative that the filtration is in operation and that the water flow indicator is fixed.

3.4.2 Locking/unlocking the keyboard

Locking the keyboard

Press and hold ▲+▼ for 3 seconds

 3 seconds

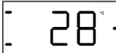

Unlocking the keyboard

Press and hold ▲+▼ for 3 seconds

 flashes for 4 seconds

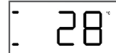



4 Maintenance

4.1 I Winterizing



- Winterizing is vital to prevent the condenser breaking due to freezing. This is not covered by the warranty.
- To avoid damaging the equipment with condensation, do not fully cover it.

- Switch off the device by pressing and holding  for 2 seconds and disconnect it or switch off the electricity supply,
- Close the water input and output valves and make sure that there is no water circulating in the heat pump,
- Drain the water from the condenser (risk of freezing) by unscrewing the water input and output connectors on the back of the heat pump,
- In the case of full winterizing for the pool (complete shutdown of the filtration system, bleed the filtration circuit or even pool drainage): tighten the two connectors by one turn to prevent any foreign bodies from getting into the condenser,
- In the case of winterizing for the heat pump only (shutdown of the heating only, the filtration keeps running): do not tighten the connectors but add 2 caps (provided) on the condenser's water inputs and outputs.
- We recommend that you put the aired winterizing micro cover on the heat pump.

EN

4.2 I Maintenance



- It is recommended that the device be general servicing at least on a yearly basis to ensure proper operation, maintain performance levels and prevent some potential failures. These operations are carried out at the user's expense, by a technician.

4.2.1 Safety instructions for appliances containing R32 refrigerant

Area check

- Before starting work on systems containing flammable refrigerants, safety checks must be carried out to guarantee a minimal ignition risk.

Work procedure

- The work must be carried out according to a controlled procedure in order to reduce the risks of releasing a flammable gas or vapour while working.

General work area

- All maintenance staff and other personnel working in the surrounding area must be made aware of the work carried out. Work conducted in enclosed areas must be avoided.

Check for the presence of refrigerant

- The area must be analysed using a suitable refrigerant detector before and during work so that the technician is informed of the presence of a potentially toxic or flammable atmosphere. Check that the leak detection equipment used is suitable for use with all refrigerants concerned, i.e. that it does not cause a spark, is correctly isolated or is entirely safe.

Check for the presence of a fire extinguisher

- If work must be carried out on the cooling equipment or any part associated therewith at a certain temperature, suitable fire extinguishing means must be within reach. Place a dry chemical fire extinguisher or CO₂ fire extinguisher near the work area.

No source of ignition

- No person carrying out work on a cooling system involving exposing the piping may use any ignition source, which could create a fire or explosion risk. All possible ignition sources, in particular cigarettes, must not enter within a sufficient perimeter of the installation, repair, removal or disposal site, in the event that refrigerant could be released into the surrounding space. Before starting the work, the area around the equipment must be examined to check for all fire or ignition risks. "No smoking" signs must be displayed.

Area ventilation

- Before accessing the unit in any manner whatsoever with the intention of performing any maintenance task, check that the area is open and well-ventilated. Suitable ventilation must be provided throughout the maintenance task to allow any refrigerant that could be released into the atmosphere to be safely dispersed.

Refrigeration equipment check

- The manufacturer's recommendations in terms of care and maintenance must always be complied with. When replacing electric components, check that components used are of the same type and category as those recommended/

approved by the manufacturer. When in doubt, contact the manufacturer's technical department for assistance.

- The following checks must be applied to installations using flammable refrigerants:
 - if an indirect cooling circuit is used, the presence of refrigerant in the secondary circuit must be analysed;
 - the markings on the equipment must remain visible and legible; any illegible markings or signs must be rectified;
 - the hoses or components of the cooling circuit are installed in a position where they are unlikely to be exposed to any substance capable of corroding the components containing refrigerant, unless the components are made from materials that are typically corrosion-proof or correctly protected from such corrosion.

Electric component check

- The repair and maintenance of electric components must include initial safety checks and component inspection procedures. If a defect capable of jeopardising safety arises, no power supply must be connected to the circuit until the problem has been completely resolved. If the defect cannot be rectified immediately and if maintenance work must continue, an appropriate temporary solution must be found. This must be reported to the equipment's owner so that all persons concerned are made aware.
- The repair and maintenance of electric components must include the following initial safety checks:
 - the capacitors are discharged: this must be carried out safely to prevent all risks of ignition;
 - no electric component or live wiring is exposed while charging, overhauling or draining the system;
 - the system must be grounded at all times.

Repair of insulated components

- When repairing insulated components, all power sources must be disconnected from the equipment on which the work is being carried out before removing the insulating cover, etc. If the equipment must be powered during maintenance work, a leak detector must continuously monitor for leaks at the most critical point in order to report any potentially hazardous situation.
- Particular attention must be paid to the following points to ensure that, when performing work on the electric components, the housing is not altered to the point of affecting the protection rating. This includes damaged wires, an excessive number of connections, terminals that do not comply with the original specifications, damaged seals, incorrect installation of the cable glands, etc.
- Make sure that the appliance is properly fixed.
- Make sure that the seals or insulating materials are not deteriorated to the point that they no longer prevent a flammable atmosphere from penetrating the circuit. Spare parts must be compliant with the manufacturer's specifications.

Repair of intrinsically safe components

- Do not apply any permanent electric capacitance or induction charge to the circuit without checking that it does not exceed the allowed voltage and intensity for the equipment being used.
- Typically safe components are the only types on which work can be carried out in the presence of a flammable atmosphere when live. The test appliance must fall under a suitable classification.
- Only replace components with parts specified by the manufacturer. Other parts could cause the refrigerant to leak and ignite in the atmosphere.

Wiring

- Check that the wiring shows no signs of wear, corrosion, excessive pressure, vibration, cutting edges or any other detrimental environmental effect. The check must also take into account the effects of ageing or continuous vibrations caused by sources such as compressors or fans.

Detection of flammable refrigerant

- Under no circumstances must potential ignition sources be used to search for or detect refrigerant leaks. A halide torch (or any other detector using a naked flame) must not be used.
- The following leak detection methods are considered to be acceptable for all cooling systems.
- Electronic leak detectors can be used to detect refrigerant leaks; however, in the case of flammable refrigerants, the sensitivity level may not be suitable or recalibration may be necessary. (The detection equipment must be calibrated in an area devoid of refrigerant). Check that the detector is not a potential ignition source and is appropriate for the refrigerant used. The leak detection equipment must be adjusted to a percentage of the refrigerant's LFL and must be calibrated according to the refrigerant used. The appropriate gas percentage (25% at most) must be confirmed.
- Leak detection fluids are also suited for use with most refrigerants, however the use of detergents containing chlorine must be avoided since it could react with the refrigerant and cause corrosion to the copper piping.
- If a leak is suspected, all naked flames must be removed/extinguished.
- If a refrigerant leak is detected and requires soldering, the entire quantity of refrigerant must be removed from the system or isolated (by way of shut-off valves) in part of the system located away from the leak.

Removal and discharge

- When accessing the cooling circuit to carry out repairs, or for any other reason, conventional procedures must be employed. However, for flammable refrigerants, the recommendations must be complied with in order to take account of the product's flammability. The following procedure must be followed:
 - remove the refrigerant;
 - purge the circuit with an inert gas;
 - drain;
 - purge with an inert gas;
 - open the circuit by cutting or soldering.
- The refrigerant charge must be recovered in suitable recovery cylinders. For appliances containing flammable refrigerants other than A2L refrigerants, the system must be bled with nitrogen devoid of oxygen to make the appliance suitable for receiving flammable refrigerants. You may need to repeat this process several times. Compressed air or oxygen must not be used to purge cooling systems.

Loading procedures

- Check that the vacuum pump outlet is not located in the vicinity of any potential ignition source and that ventilation is provided.

- In addition to conventional charging procedures, the following requirements apply.
 - Check that there is no possibility of cross-contamination between the different refrigerants when using charging equipment. Hoses or lines must be as short as possible to reduce the quantity of refrigerant contained therein.
 - Cylinders must be kept in an appropriate position, in accordance with the instructions.
 - Check that the cooling system is grounded before charging the system with refrigerant.
 - Label the system once charging is complete (if this is not already the case).
 - Pay close attention to not overfilling the cooling system.
- Before recharging the system, carry out a pressure test using a suitable purge gas. The system must be examined to make sure there are no leaks after the charging operation and before commissioning. A follow-up leak test must be carried out before leaving the site.

Dismantling

- Before dismantling, the technician must familiarise himself/herself with the equipment and its specifications. We highly recommend carefully recovering all refrigerants. Before this, oil and refrigerant samples must be taken if analyses are to be carried out before any other use of the recovered refrigerant. Check for the presence of a power supply before starting work.
 1. Familiarise yourself with the equipment and how it operates.
 2. Electrically isolate the system.
 3. Before starting work, check the following points:
 - mechanical handling equipment is available if needed to handle the refrigerant cylinders;
 - all personal protective equipment is available and used correctly;
 - the recovery process is monitored at all times by a cognisant person;
 - the recovery cylinders and equipment comply with the relevant standards.
 4. Drain the cooling system where possible.
 5. If a vacuum cannot be created, install a manifold in order to be able to remove the refrigerant from various locations within the system.
 6. Make sure that the cylinder is located on the scales before starting recovery operations.
 7. Start the recovery unit and operate as per its instructions.
 8. Do not overfill the cylinders (no more than 80% of the volume must be filled with liquid).
 9. Do not exceed the maximum working pressure of the cylinder, even temporarily.
 10. When the cylinders have been filled correctly and the process is complete, check that the cylinders and the equipment are quickly removed from the site and that the alternative shut-off valves on the equipment are closed.
 11. The recovered refrigerant must not be charged in another cooling system, unless it has been cleaned and inspected.

4.2.2 User maintenance

- Make sure that the filter is not blocked by any foreign bodies.
- Clean the evaporator (for location see § "1.3 I Dimensions and marking") using a soft brush and a fresh water spray (disconnect the power cable); do not fold over the metal wings, then clean the condensation drainage pipe to remove any impurities that may be blocking it.
- Do not use a high pressure jet. Do not spray with rain water, salt water or water which is full of minerals.
- Clean the outside of the device; do not use any solvent-based products. We can provide you with a specific cleaning kit as an accessory: the PAC NET, see § "1.1 I Description".

4.2.3 Maintenance to be carried out by a qualified technician



- **Please read the safety instructions provided in the chapter entitled «4.2.1 Safety instructions for appliances containing R32 refrigerant» before performing any of the maintenance operations described below.**

- Check that the regulation is operating correctly connected.
- Check that the condensation flows correctly when the device is operating.
- Check the safety mechanisms.
- Check the connection of the metal masses to the earth.
- Check that the electrical cables are correctly tightened and connected and that the electrical unit is clean.



5 Troubleshooting

















- Before you contact your reseller, please carry out these few simple checks using the following tables if a problem occurs.
- If the problem continues contact your reseller.
- : Actions reserved for a qualified technician

5.1 I Device behaviour

The device does not start heating straight away	<ul style="list-style-type: none"> • On start-up, the device remains "paused" for 5 minutes before it starts operating. • When the setpoint temperature is reached, the heat pump stops heating: the water temperature is higher than or equal to the setpoint temperature. • When the water flow rate is zero or is not enough, the heat pump stops: check that the water is circulating correctly in the heat pump and that the hydraulic connections are correct. • The heat pump stops when the outdoor temperature falls below 5 °C for standard models or -5 °C for "Defrost" models. • It may be that the heat pump has detected an operating fault (see § "5.2 I Error code display"). • If you have checked these points and the problem persists: contact your reseller.
The device is draining water	<ul style="list-style-type: none"> • Often called condensation, this water is the moisture contained in the air which condenses on contact with certain cold mechanisms in the heat pump, especially on the evaporator. The more damp the air, the more condensation your heat pump will produce (your device may drain several litres of water per day). This water is retrieved by the base of the heat pump and drained through a hole. • To check that the water is not coming from a leak in the pool circuit on the heat pump, shut down the heat pump, wait a few minutes and run the filtration pump for the water to circulate in the heat pump. If the water continues to flow through the condensation drain, there is a water leak in the heat pump; contact your reseller.
The evaporator is iced over	<ul style="list-style-type: none"> • Your heat pump will soon switch to its defrost cycle to melt the ice. • If your heat pump cannot manage to deice its evaporator, it will stop itself; this means that the outdoor temperature is too low (below 5 °C for standard models, -5 °C for "Defrost" models).
The device is not working	<ul style="list-style-type: none"> • If there is no display, check the supply voltage and the F1 fuse. • When the setpoint temperature is reached, the heat pump stops heating: the water temperature is higher than or equal to the setpoint temperature. • When the water flow rate is zero or is not enough, the heat pump stops: check that the water is circulating correctly in the heat pump. • The heat pump stops when the outdoor temperature falls below 5 °C for standard models or -5 °C for "Defrost" models. • It may be that the heat pump has detected an operating fault (see § "5.2 I Error code display").
The device is working but the water temperature does not increase	<ul style="list-style-type: none"> • It may be that the heat pump has detected an operating fault (see § "5.2 I Error code display"). • Check that the automatic filling valve is not stuck in open position; this will keep supplying cold water into the pool and will prevent the temperature from rising. • There is too much heat loss as the air is cool. Install a heat insulated cover on your pool. • The heat pump is unable to capture enough calories as its evaporator is clogged with dirt. Clean it to restore its performances (see § "4.2 I Maintenance"). • Check that the external environment is not hindering the heat pump (see § "2 Installation"). • Check that the heat pump is the right size for this pool and its environment.
The ventilator is running but the compressor stops from time to time with no error message	<ul style="list-style-type: none"> • If the outdoor temperature is low, the heat pump will perform defrost cycles. • The heat pump is unable to capture enough calories as its evaporator is clogged with dirt. Clean it to restore its performances (see § "4.2 I Maintenance").
The device trips the circuit breaker	<ul style="list-style-type: none"> • Check that the circuit breaker is correctly dimensioned and that the cable section used is the right one (see § "1.2 I Technical specifications"). • The supply voltage is too low; contact your electricity supplier.

5.2 | Error code display

Display of	Possible causes	Solutions
 Air temperature sensor fault	SD2 sensor is offline or incorrectly connected	 Sensor replacement
 Deicing sensor fault	SD3 sensor is offline or incorrectly connected	 Sensor replacement
 Low-pressure fault	Low pressure fault in the cooling circuit (if fault persists after acknowledgement)	 Call an approved technician
 High-pressure fault	Air and water emulsion passed into the device	Check the pool's hydraulic circuit
	Insufficient water flow	Increase flow using by-pass, check that the pool filter is not clogged
	Water temperature too high (32 °C maximum)	Wait until the temperature falls
	Flow controller blocked	 Check the flow controller
	Water condenser scaled up or blocked	 Clean the water condenser
	Outside temperature > 30°C and measured water temperature > 30 °C	Close the bypass valve to increase the flow rate through the device
 Water temperature sensor fault	SD1 sensor is offline or incorrectly connected	 Sensor replacement
 Deicing cycle fault (>20 minutes)*	Air temperature too low	Wait until the temperature is within the operating range
	The evaporator is scaled up	Clean the evaporator (see § "4.2 Maintenance")
	The ventilator does not work	 Replace the ventilator or the electronic board
	Wrong value provided by the air or deicing sensor	 Replace the sensor.

* Error code not active on "Defrost" models.

EN

5.3 I Wiring diagrams

5.3.1 "Standard" models

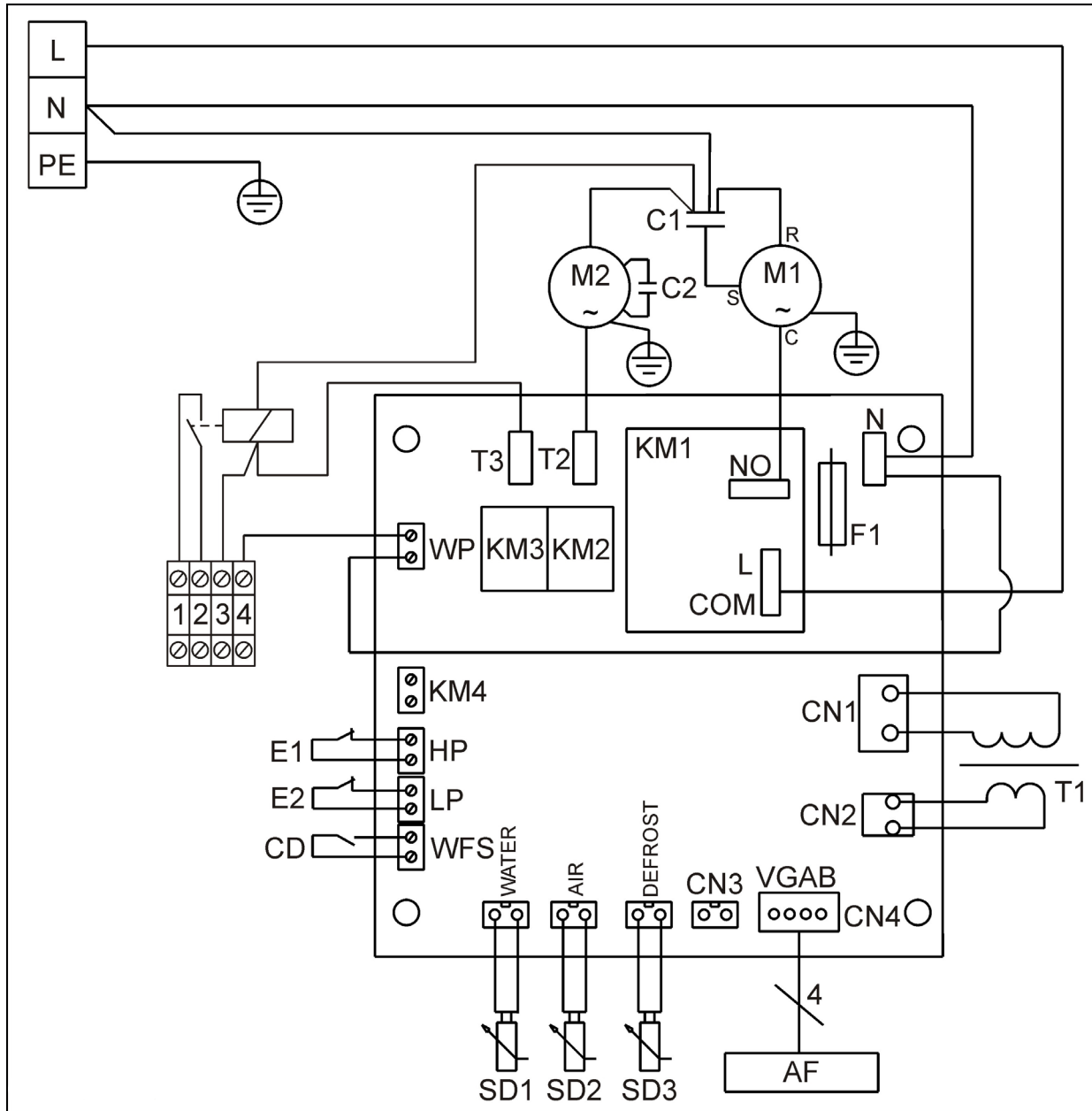

L-N-PE	230V-1N-50Hz protected power supply
AF	Digital display
⏏	Earth
C1	Compressor condenser
C2	Ventilator condenser
CD	Flow controller
E1	High pressure switch
E2	Low pressure switch
F1	Fuse
KM1	Compressor relay

KM2	Ventilator relay
KM3	Auxiliary pump relay
KM4	Complementary relay
M1	Compressor
M2	Ventilator
SD1	Water temperature sensor
SD2	Air temperature sensor
SD3	Defrost sensor
T1	Transformer
1-2-3-4	Terminal for heating priority connection

5.3.2 "Defrost" models

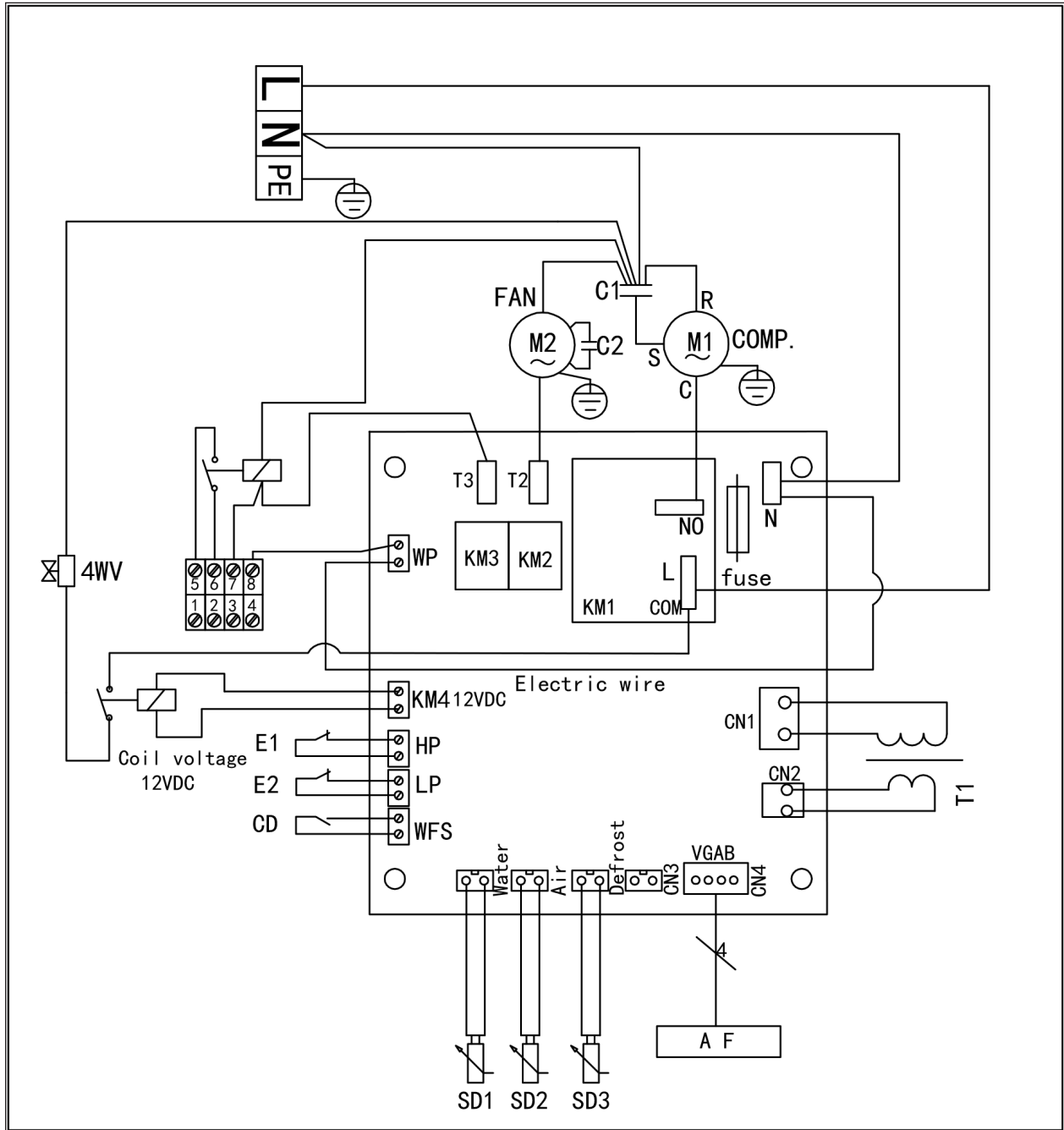

EN

L-N-PE	230V-1N-50Hz protected power supply
AP	Digital display
⊥	Earth
C1	Compressor condenser
C2	Ventilator condenser
CD	Flow controller
HP	High pressure switch
LP	Low pressure switch
F1	Fuse
KM1	Compressor relay

KM2	Ventilator relay
KM3	Auxiliary pump relay
KM4	Complementary relay
M1	Compressor
M2	Ventilator
SD1	Water temperature sensor
SD2	Air temperature sensor
SD3	Defrost sensor
T1	Transformer
1-2-3-4	Terminal for heating priority connection

Votre revendeur
Your retailer

Modèle appareil
Appliance model

Numéro de série
Serial number

Pour plus d'informations, enregistrement produit et support client :
For more information, product registration and customer support:

www.zodiac.com

