

DW 735

CÓD. 066122CLM / 066122CLG / 066122CLS

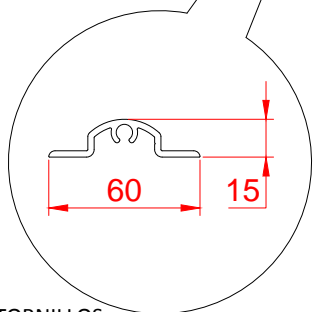

TORNILLOS
SCREWS
VIS
DIN7982 5.5 x 50

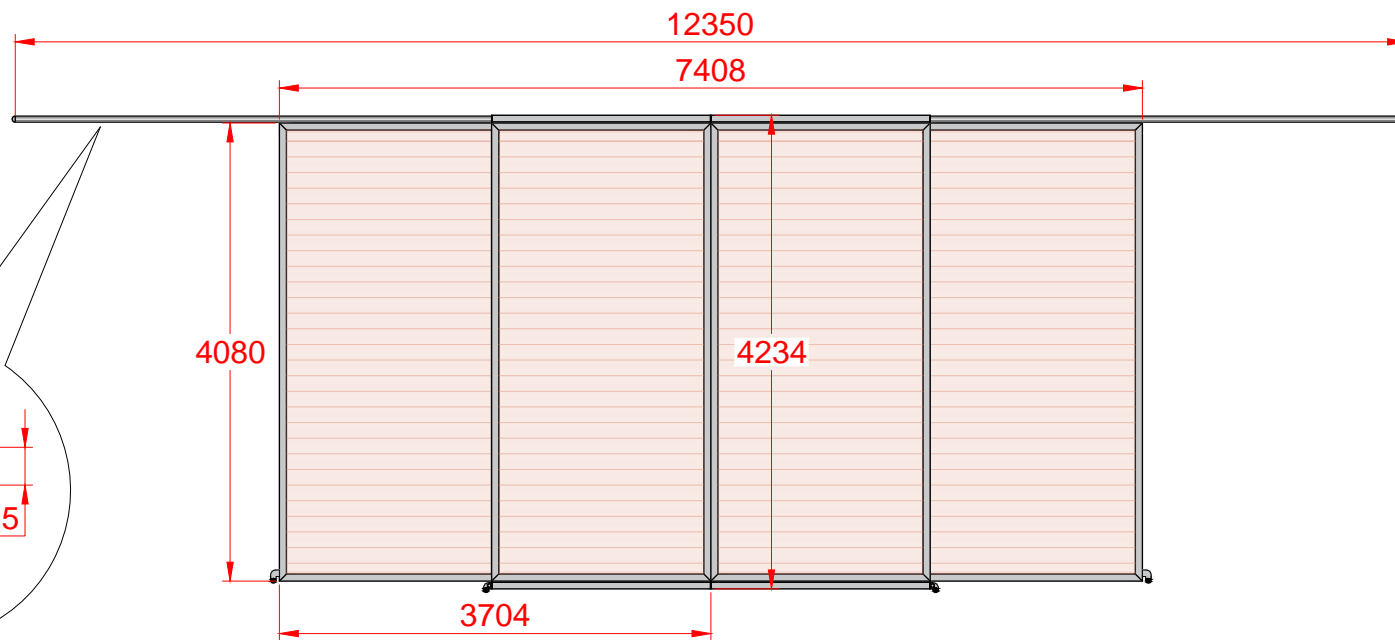
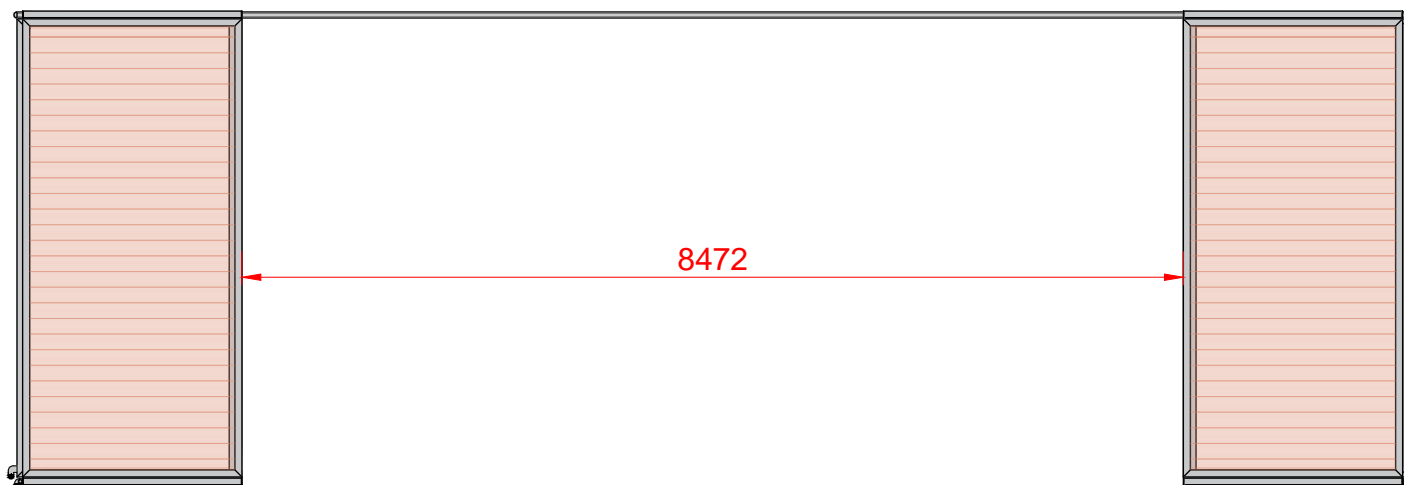

Section A-A'

DW 735

CÓD. 066122CLM / 066122CLG / 066122CLS

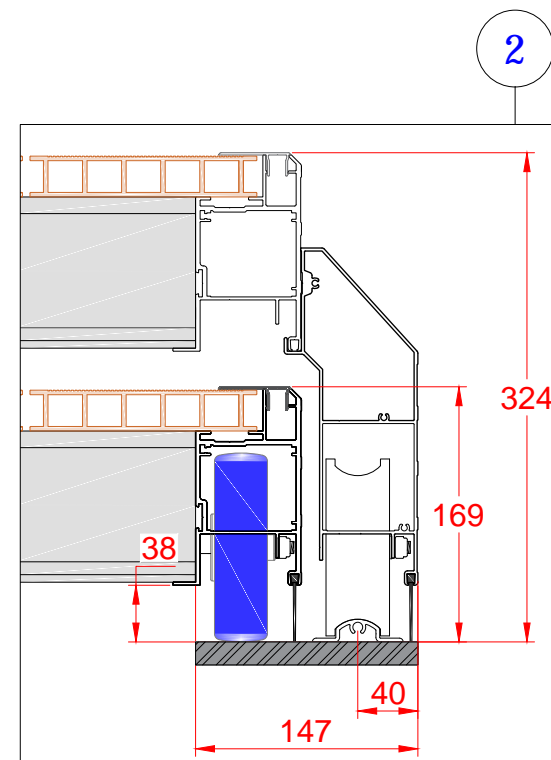
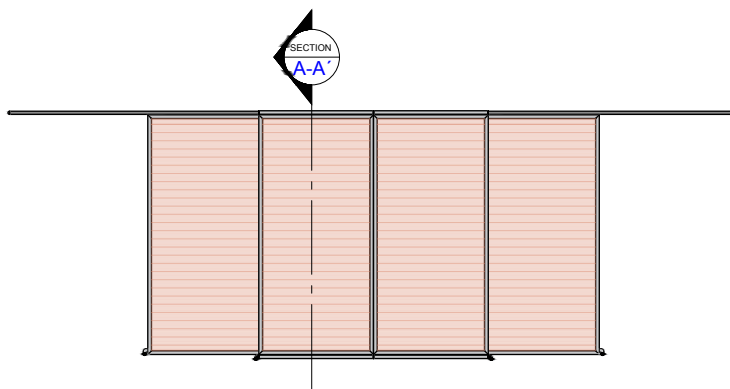
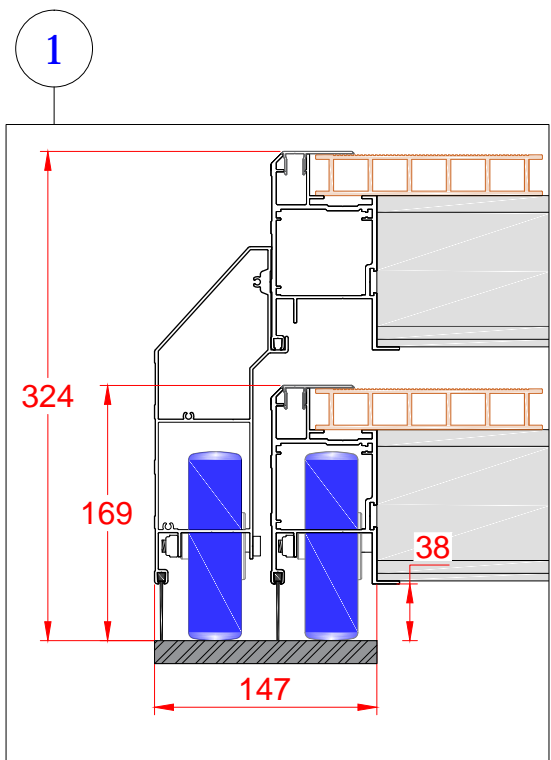
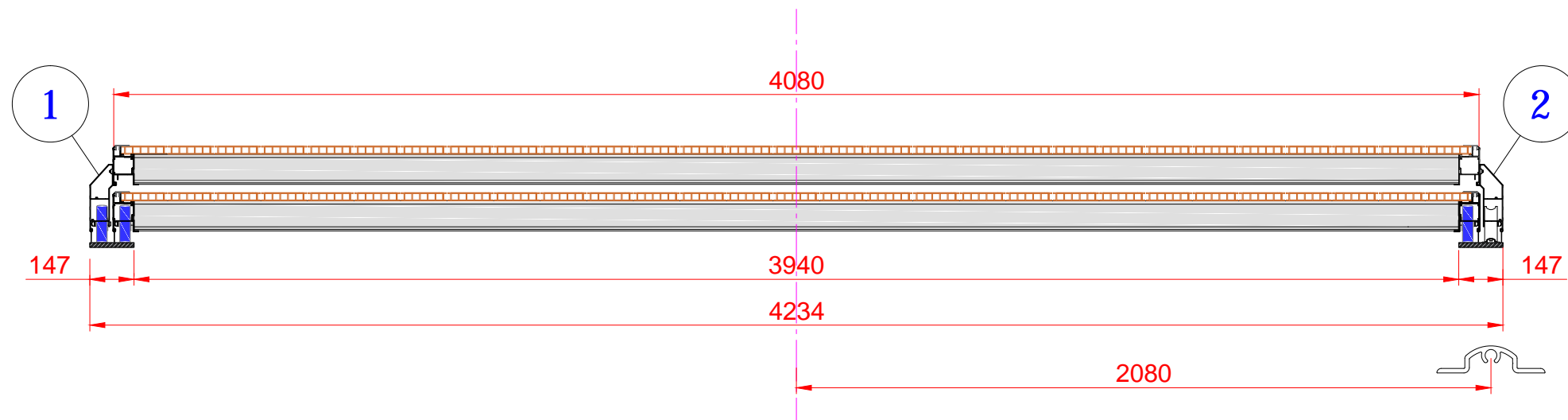

Section B-B'

DW 735 Cód. 066122CLM / 066122CLG / 066122CLS

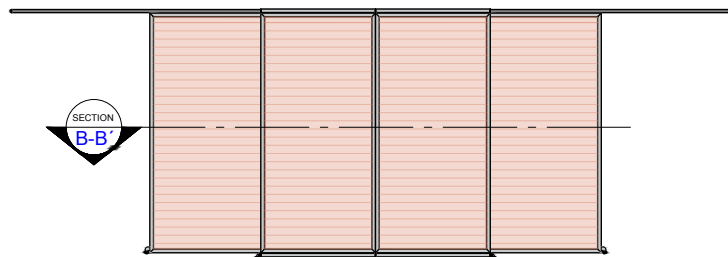
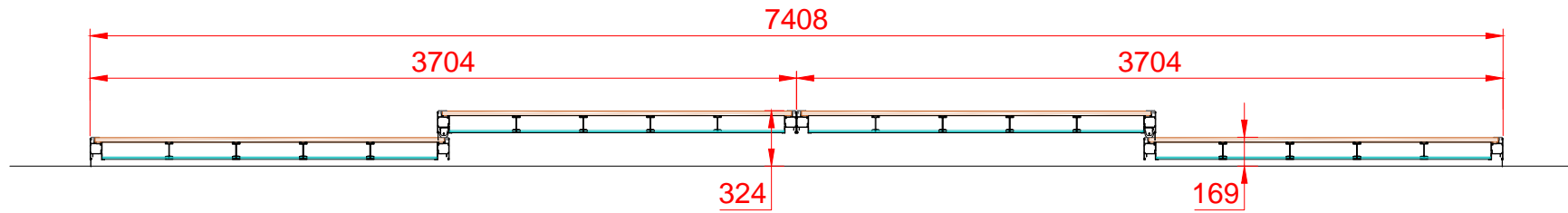

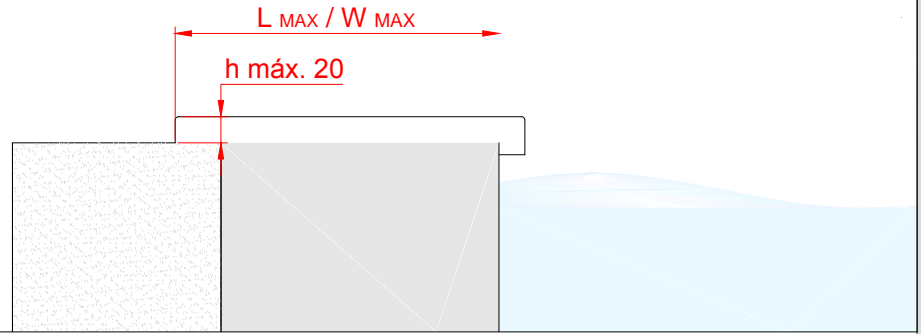

DW 735			
L_{MAX}	7200	W_{MAX}	3750

