

Haier

FREESTANDING RANGE

HOR54S4CCRW1

HOR54S4CERW1

HOR60S4CCRW1

HOR60S4CERW1

INSTALLATION AND USER GUIDE

NZ AU

CONTENTS

Safety and Warnings	4
Dimensions	8
Installation Instructions	10
Product Overview	15
User Guide	16
Cooking Guidelines	23
Care & Cleaning	24
Troubleshooting	27
Manufacturer's Warranty	30
Customer Care	31

SAFETY AND WARNINGS

Your safety is important to us. Please read this information before using your freestanding range.

INSTALLATION

WARNING!	
	<p>Electric Shock Hazard Failure to follow this advice may result in electric shock or death.</p> <ul style="list-style-type: none">• Disconnect the appliance from the mains electricity supply before carrying out any work or maintenance.• Connection to a good earth wiring system is essential and mandatory.• Alterations to the domestic wiring system must only be made by a qualified electrician.

IMPORTANT SAFETY INSTRUCTIONS!

- Read these instructions carefully before installing this product.
- Save these instructions for the local electrical inspector's use.
- Installation must comply with your local building and local electricity regulations.
- The manufacturer's electrical installation instructions for product MUST be followed when installing the cooker.
- This appliance is to be installed and serviced only by trained and supported service technician or qualified person.
- The manufacturer accepts no responsibility for the incorrect installation of appliances.
- Incorrect installation may result in personal injury, damage to property and may invalidate any warranty or liability claims.
- The fixed wiring to the cooker must be provided with a switch operating in all active conductors, mounted near the appliance in a visible and readily accessible position in accordance with AS/NZS 3000. The switch shall provide full disconnection under overvoltage category III in accordance with the wiring rules. In New Zealand only, a freestanding cooking appliance shall be connected to the electrical installation wiring by a socket-outlet or an installation coupler. The cooker lead shall have a minimum current rating of 32 A and a minimum temperature rating of 50 °C
- Do not install or operate the appliance if it is damaged or not working properly. If you receive a damaged product, contact your dealer or installer immediately.
- The appliance must be installed in line with the minimum clearances stated in this manual in order to avoid overheating & damage to adjacent cabinetry.
- Do not place the cooker on a base raised above floor level
- Do not install the cooker behind a decorative door in order to avoid overheating
- **WARNING! In order to prevent accidental tipping of the cooker, for example by a child climbing onto the open door, the stabilizing means must be installed.**

- Packing elements (eg plastic bags, polystyrene foam, staples, packing straps etc) and tools should not be left around during and after installation, especially if they are within easy reach of children, as these may cause serious injuries.
- Make sure you recycle the packaging material.
- Before disposing of any appliance, make sure that it can no longer be used and that all hazardous parts are removed or made harmless, so that children playing with the old appliance cannot harm themselves.
- These appliances are registered in EESS for New Zealand & Australia.
- Do not modify this appliance.
- Do not use or store flammable materials on or near this appliance.
- Do not spray aerosols in the vicinity of this appliance while it is in operation.

OPERATION AND MAINTANENCE

WARNING!	
	<p>Electric Shock Hazard Failure to follow this advice may result in electric shock or death.</p> <ul style="list-style-type: none"> • Switch the power to the cooker off at the wall before cleaning or maintenance (replacing the oven lamp, etc.). • Do not cook on a broken or cracked cooktop. If the glass should break or crack, switch the appliance off immediately at the mains power supply (wall switch) and contact a qualified technician.

WARNING!	
	<p>Fire Hazard Failure to follow this advice may result in serious injury.</p> <ul style="list-style-type: none"> • The cooking process has to be supervised. A short term cooking process has to be supervised continuously. Boil over causes smoking and greasy spill overs that may ignite. • Do not store items on the cooking surfaces • Do not place aluminium foil, dishes, trays, water or ice on the oven floor during cooking, as doing so will irreversibly damage the enamel; lining the oven with aluminium foil or single use protection available from stores may even cause fire. • Never use your appliance for warming or heating the room. Doing so may result in overheating of the appliance and a fire may start.

WARNING!	
	<p>Hot Surface Hazard Failure to follow this advice may result in serious injury.</p> <ul style="list-style-type: none"> • Accessible parts may become hot when in use. • To avoid burns and scalds, be careful not to touch any hot part and keep children away. • Do not let your body, clothing or any item other than suitable cookware contact the ceramic glass until the surface is cool. • Metallic objects such as knives, forks, spoons and lids should not be placed on the hob surface as they can get hot quickly, • Handles of saucepans maybe hot to touch. Check saucepan handles do not overhang other cooking zones that are on. Keep handles out of reach of children. • Use oven mitts or other protection when handling hot surfaces such as oven shelves or dishes. • Use care when opening the oven door. Let hot air or steam escape before removing or replacing food. • Do not touch heating elements or interior surfaces of the oven. Heating elements maybe hot even though they are dark in colour. • Interior surfaces of an oven become hot enough to cause burns. • During and after use, do not touch, or let clothing or other flammable materials contact heating elements or interior surfaces of the oven until they have had sufficient time to cool. • Other surfaces of the appliance may become hot enough to cause burns - among these surfaces are the oven vent, the surface near the oven vent, and the oven door. • Before cleaning, turn the product off and make sure the whole product is cooled down.

IMPORTANT SAFETY INSTRUCTIONS!

- The cooker becomes hot during operation. Take care not to touch the hot parts inside the oven.
- Always keep children away from the cooker. Children should be supervised to ensure that they do not play with the cooker. While in operation direct contact with the cooker may cause burns!
- Ensure that other household equipment's power cords, etc. do not touch the hot oven or the hob as the insulation material of this equipment is usually not resistant to high temperatures.
- Always keep oven vents unobstructed.
- Do not place aluminium foil or plastic dishes on the cooktop surface.
- Do not leave the cooker unattended when frying. Oils and fats may catch fire due to overheating.
- Do not use water on grease fires. Smother the fire or flame or use a dry chemical or foam type extinguisher.
- Use only dry oven mitts or potholders. Moist or damp potholders on hot surfaces could result in burns from steam. Do not let potholders touch hot areas or heating elements. Do not use a towel or a bulky cloth for a potholder. It could catch fire.
- Placement of oven shelves: always position shelves in the desired location while the oven is cold (before preheating). If a shelf must be removed while the oven is hot, do not let the oven mitts or potholder contact hot heating elements in the oven or the base of the oven.
- When the shelf is placed inside the oven, make sure that the stop is directing upwards, positioned in the back of the cavity and inserted completely.

- Do not allow the cooktop to get soiled and prevent liquids from boiling over onto the surface of the cooktop. Any spillages should be cleaned up as they happen.
- Do not attempt to wipe off any spillage on the coil tray or stove surface when the coil is hot, as it is unsafe.
- Do not place pans with a wet bottom on the warmed up heating zones as this can cause irremovable stains to the cooktop.
- Do not put pans weighing over 15kg on the opened door of the oven and pans over 25kg on the cook top.
- Do not use harsh/abrasive cleaning agents or sharp metal objects to clean the freestanding range. Doing so may damage the enamel coating of oven inner surface, scratch the glass surface, which could then result in the glass cracking.
- Do not use the freestanding range in the event of a technical fault. In the event of any incident caused by a technical fault, disconnect the power and report the fault to the service centre and book a qualified and authorized person to repair the product.
- The rules and provisions contained in this instruction manual should be strictly observed. Do not allow anybody who is not familiar with the contents of this instruction manual to operate the freestanding range.
- The freestanding range should not be cleaned using steam equipment.
- **WARNING! In order to prevent accidental tipping of the freestanding range, for example by a child climb onto the open door, the stabilizing means must be installed.**
- The oven must be switched off before removing the removable parts. After cleaning, reassemble them according to the instructions.
- Ensure that the freestanding range is switched off before replacing the lamp to avoid the possibility of electric shock.
- **WARNING! Accessible parts will become hot when the grill is in use. Children should be kept away.**
- The freestanding range is not intended to be operated by means of an external timer or separate remote-control system.
- This freestanding range is not intended for use by persons (including children) with reduced physical, sensory or mental capabilities, or lack of experience and knowledge, unless they have been given supervision or instruction concerning use of the freestanding range by a person responsible for their safety.
- If the supply cord is damaged, it must be replaced by the manufacturer or its service agent or a similarly qualified person in order to avoid a hazard.
- **WARNING! Never remove the oven door seal.**
- Do not clean the oven seal or use any oven-cleaning products on it. It is essential for a good seal, which ensures that the oven operates efficiently. Care should be taken not to rub, damage or move it.
- Use pans that are specified by the manufacturer as designed for use with a ceramic or coil hob dependent on your products cooktop type.
- If the cooktop surface is cracked, switch off the freestanding range to avoid the possibility of electric shock.
- Do not use pans with sharp edges or drag pans across the cooktop glass which may scratch or cause damage to the ceramic hob.
- **WARNING! Take care not to drop any heavy or sharp objects on the cooktop. The glass is tough, but sharp or heavy objects falling on it (e.g. pepper mill, heavy-based frying pan) may crack or chip it.**
- **This appliance complies with electromagnetic safety standards.**

PRODUCT DIMENSIONS

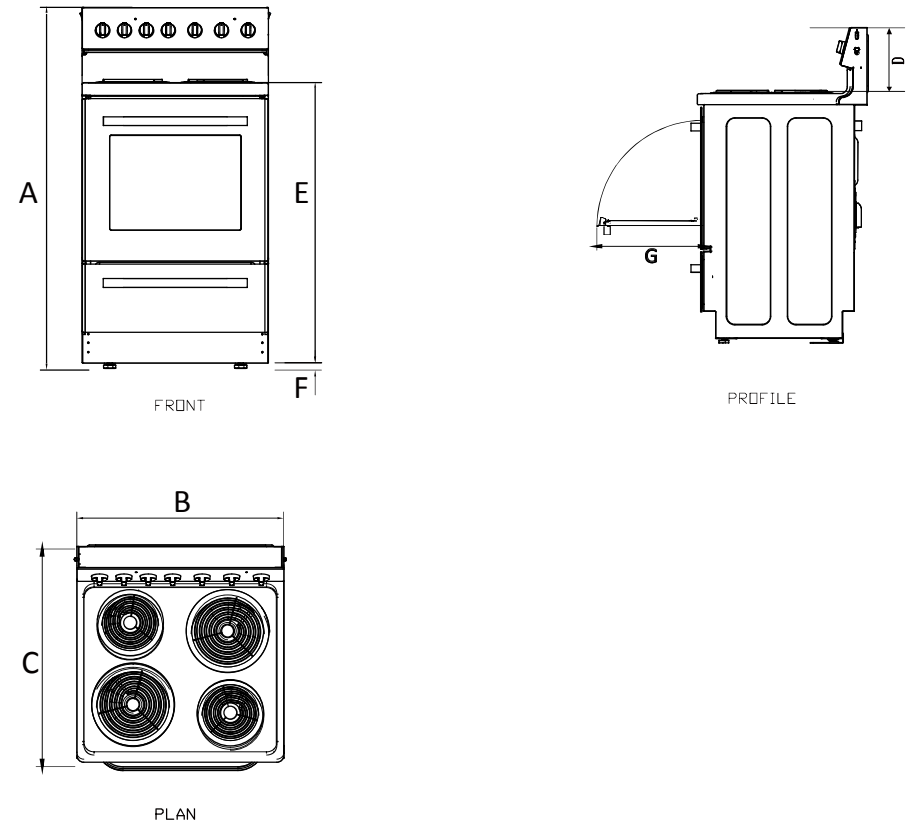

PRODUCT DIMENSIONS

		mm
A	Overall height (from floor to top of cooktop, excluding splashback)	min 1143 max 1153
B	Overall width	595/540
C	Overall depth (from front of cooker to rear of splashback, excl. handles and dials)	620
D	Height of splashback	240
E	Height of chassis (excluding adjustable feet)	895
F	Adjustable feet height	min 5 max 15
G	Depth of open door to front of freestanding range	510

CUTOUT & CLEARANCE DIMENSIONS

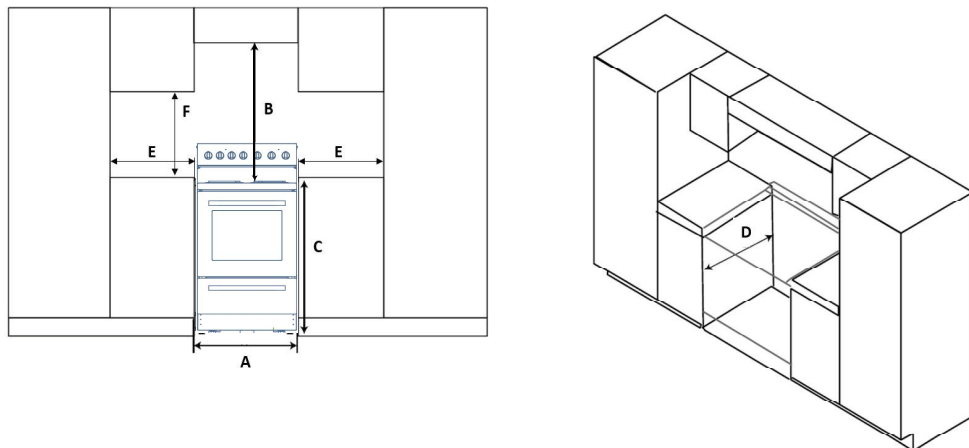

CUTOUT & CLEARANCE DIMENSIONS

	mm
A Minimum width of cabinetry opening	600/545
B Minimum clearance from cooking surface to: - Overhead cabinet centred above the cooktop - Ventilation hood centred above the cooktop	600
C Height of cabinetry immediately adjacent to the cooker (from floor to countertop)*	900-910
D Maximum depth from wall to cabinetry face	620
E Minimum clearance from left and right edge of cooker to nearest vertical combustible surface	100
F Minimum vertical distance between benchtop and cabinet extending above counter	450

* Depending on the height of the feet adjustment. The cooking surface must sit flush or above benchtop level.

IMPORTANT! The cabinetry surrounding the cooker must be heat resistant and capable of withstanding temperatures of 75°C above room temperature.

UNPACKING

During transportation, protective packaging was used to protect the appliance against any damage.

After unpacking, please dispose of all elements of packaging appropriately and in a way that will not cause damage to the environment. All materials are marked with the related symbol to guide you around recommended disposal method.

IMPORTANT! Packing elements (plastic bags, polystyrene foam, staples, packing straps, etc.) should not be left around during and after installation, especially if they are within easy reach of children, as these may cause serious injuries.

INSTALLATION INSTRUCTIONS

Before you start

- The installation, the adjustments, conversions and maintenance listed in this part must only be carried out by qualified persons.
- Do not place the freestanding range on a base raised above floor level.
- Do not install the freestanding range behind a decorative door in order to avoid overheating.
- Please read all information covered in "Cutout & Clearance Dimensions" section.
- Do not install the freestanding range near flammable materials (eg curtains).
- The freestanding range should stand on a hard & even floor.
- Peel off the protective film on side panels

Cabinetry requirements

IMPORTANT! The cabinetry surrounding the freestanding range must be heat resistant and capable of withstanding temperatures of 75°C above room temperature.

This prevents surface deformation or detachment of the coating. If you are unsure of your cabinet's heat resistance, you should leave approximately 2 cm of free space around the cooker. The wall behind the cooker should be resistant to high temperatures. During operation, its back side can warm up to around 50°C above the ambient temperature.

Ventilation requirements

A suitable ventilation grid or hood may be installed above the cooker. Hoods should be installed according to the manufacturer's instructions.

The socket

When the maximum current of the small furnace plate and socket exceeds the limit, the current overload protector will cut off the power supply, and the subsequent operation will only be reset by pressing the key of the current overload protector.

Levelling the freestanding range

Before starting to use the freestanding range it should be levelled, which is particularly important for even oil distribution in a frying pan. To this purpose, adjustable feet are provided with the product.

1. Tilt the freestanding range slightly to have access to the feet from the bottom
2. Adjust the screws as necessary
3. Tilt the freestanding range back to its upright position
4. Follow the same steps above for adjusting the feet on the opposite side

Adjustment range is 10 mm.



IMPORTANT! Freestanding range needs to be supported properly when tilted to avoid any possible hazard.

Moving the freestanding range

Do not lift the freestanding range by the oven door handle, the hob rail or by lifting the cooktop trim as this may damage the appliance.

When moving freestanding range to its final position **DO NOT DRAG**, lift feet clear of floor.

Installing the anti-tip device

Step 1

Drill 4 holes on to ground at the back of where the freestanding range will be placed according to the dimensions in the pictures.

Hole diameter is min \varnothing 8mm depend on the anchor diameter.

Depth of the holes is min 60mm.

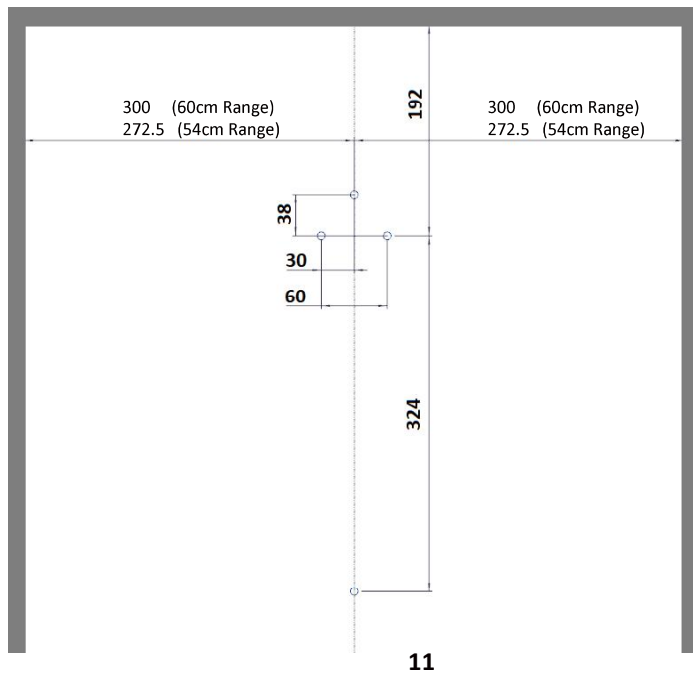

Step 2

Fix the anti-tilt bracket with 3 screws and 3 anchors.

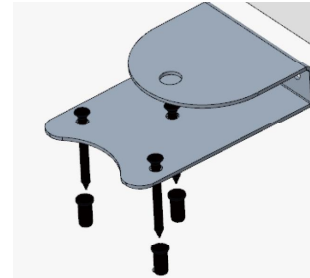

Step 3

Push to product to engage anti-tilt bracket.

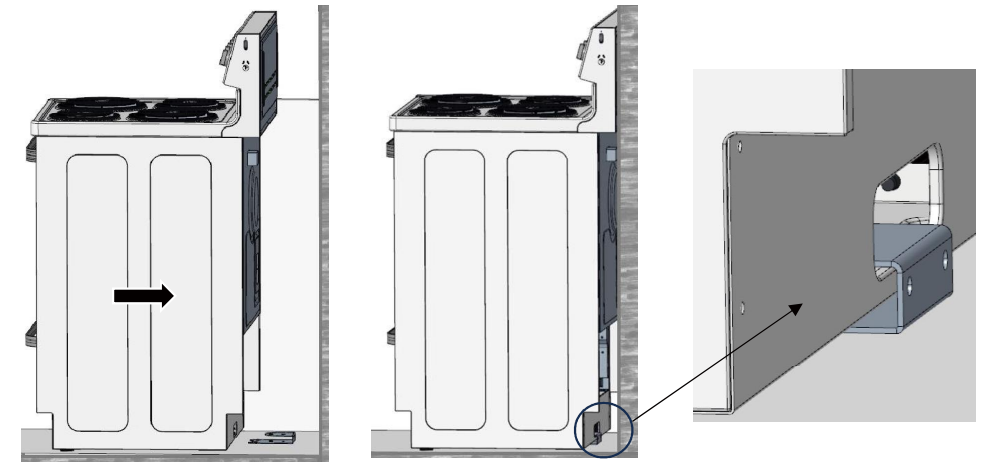

Step 4

Remove drawer as defined in pictures. Pull out drawer by pushing the bar downwards on the right side and upwards on the left side.

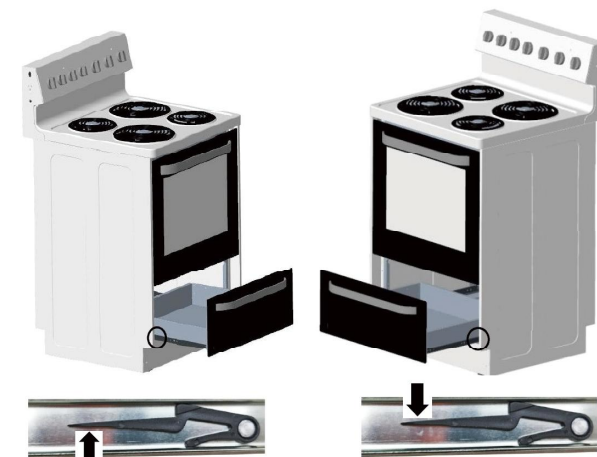

Step 5

Deadbolt Assembly on the ground at the front of where the freestanding range will be placed.

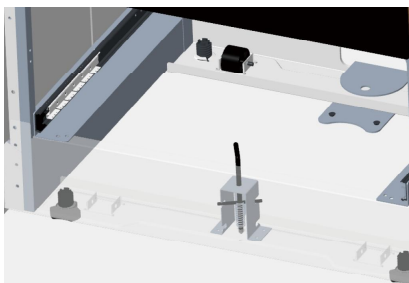

First Position of Deadbolt	Turn bar to the left to release it from the lock	Push it downwards so that it settles into the hole.	Turn the bar to the right again to ensure that it is locked.

Step 6

Mount the drawer to the product by reversing the steps in step 4.

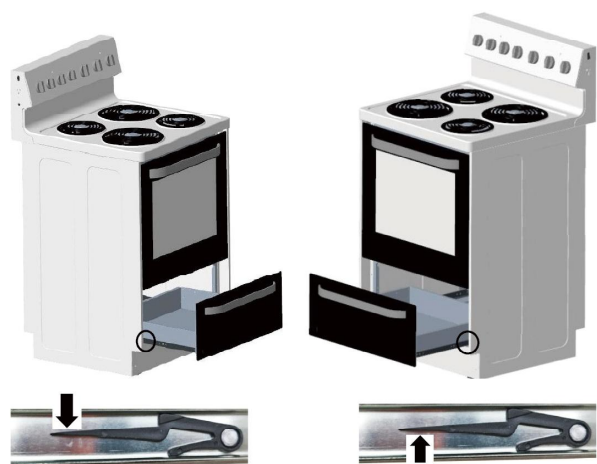

Electrical connection

IMPORTANT! All electrical work should be carried out by a suitably qualified and authorized electrician.

- If the installation requires alterations to the domestic electrical system, call a qualified electrician. The electrician should also check that the electrical system is suitable for the electricity drawn by the cooker.
- The appliance must be connected to the mains electricity supply, checking that the voltage corresponds to the value given in the rating plate and that the electrical cable sections can withstand the load specified on the plate.
- The power supply cable must not touch any hot parts and must be positioned so that it does not exceed 75°C at any point.
- Replacements should only be made by a qualified electrician.

The fixed wiring to the freestanding range must be provided with a switch operating in all active conductors mounted near the appliance in a visible and readily accessible position in accordance with AS/NZS 3000. The switch shall provide full disconnection under overvoltage category III in accordance with the wiring rules.

Connection – New Zealand Only

In New Zealand only, a freestanding cooking appliance shall be connected to the electrical installation wiring by a socket-outlet or an installation coupler.

The cooker lead shall have a minimum current rating of 32 A and a minimum temperature rating of 50 °C

Model Code	Max Power (W)	HZ	Voltage (V)	Amps (A)
HOR54S4CCRW1	10000	50	220-240 / 380-415	35
HOR54S4CERW1	10000	50	220-240 / 380-415	35
HOR60S4CCRW1	10000	50	220-240 / 380-415	35
HOR60S4CERW1	10000	50	220-240 / 380-415	35

Connecting to the power supply:

1. Open the terminal box lid by inserting a screw driver to the slots located at the bottom of the lid and gently lifting up the clips.
2. Feed the power supply cable through the clamp.
3. Connect the phase, neutral & earth wires as shown in "Connection diagram" below.
4. Take up any slack in the cable and secure with the clamp.
5. Close the lid securely.

Note: The earth wire must be left longer than the other wires.

CONNECTION DIAGRAM		Recommended type of connection lead
Caution! Voltage of heating elements 220-240V Caution! In the event of any connection the safety Wire must be connected to the ⊕ E terminal.		
1	For 220-240V earthed one-phase connection, bridges connect 1-2-3 terminals and 4-5 terminals, safety wire to ⊕.	H05VV-F3G6
2	For 380-415 earthed three-phase connection, bridges connect 4-5 terminals, phases in succession 1, 2 and 3, earth to ⊕.	H05VV-F5G1.5
L1=R, L2=s, L3=T, N=Null Terminal, E=safety wire terminal		

IMPORTANT! Remember to connect the earth (safety) wire to the corresponding location on the connection terminal box as shown above.

PRODUCT OVERVIEW

LOCATION OF GAS AND ELECTICITY CONNECTIONS	MM
A Height electrical connection above floor	460
B Distance electrical connection from product side	165

Socket current overload protector:10A

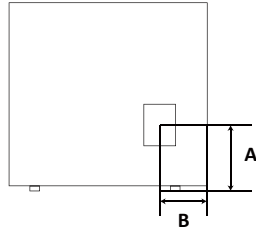

Thank you for purchasing a Haier Freestanding Cooker.

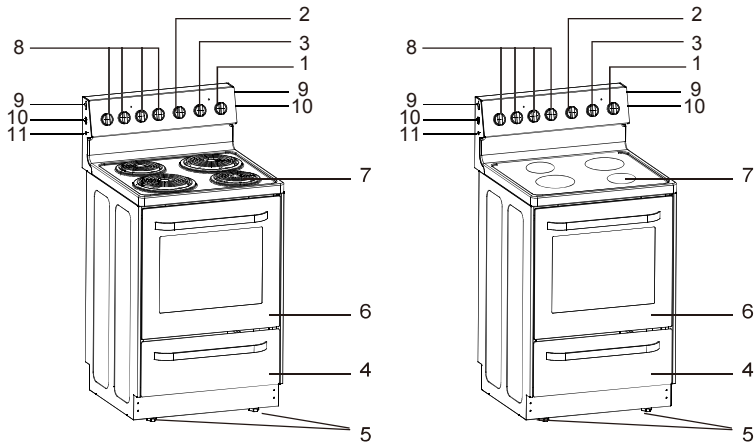

Number	Parts	Quantity
1	Temperature Control Dial	1
2	Minute Minder	1
3	Oven Function Selection Dial	1
4	Storage Drawer	1
5	Foot	4
6	Oven Door	1
7	Hot Plate	1
8	Hob control knobs	4
9	Outlet switch	2
10	Outlet	2
11	Switch protector	1

USING YOUR freestanding range

Before using the freestanding range for the first time

- Read this user guide, taking special notice of the 'Safety and Warnings' section.
- Remove all accessories and packaging from the oven and cooktop. If any adhesive residue is left on surfaces, remove this using dishwashing liquid on a soft cloth. Do not use any harsh or abrasive cleaners
- **Conditioning the oven**
 - Wipe out the interior of the oven & the cooktop using a damp cloth with warm soapy water, then wipe it dry.
 - Ensure the power supply to the cooktop is turned on.
 - Select the Bake function, set the temperature to 200°C for 30 minutes.
 - There will be a distinctive smell which is normal, make sure your kitchen is ventilated during this process.
 - Once cooled, wipe out the interior of the oven using a damp cloth with warm soapy water.

Control panel

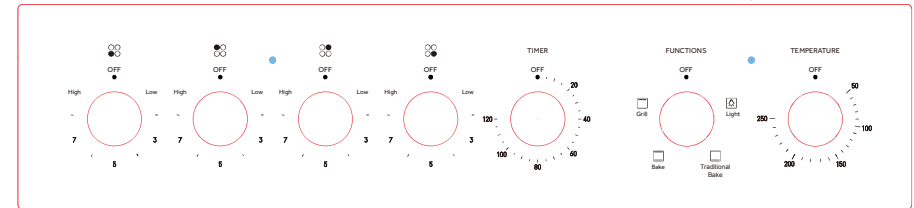

Cooking Functions

	Light		Traditional Bake
	Bake		Grill

Cook Function Operation

The oven is controlled by the function dial and the temperature control dial. To operate the oven, follow the instructions below:

1. Turn the function dial to the desired function.

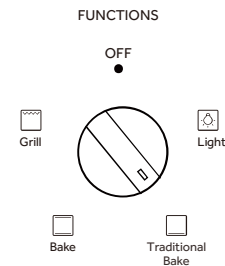

2. Turn the temperature dial to the desired cooking temperature.

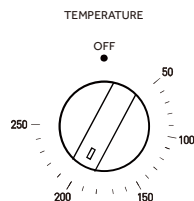

3. Optional – Set Minute Minder

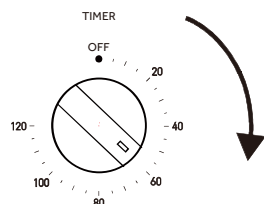

When the time is complete a bell will ring to indicate the end of the cooking period.

Note: The timer does not turn the oven off when the time is complete

Caution!

When selecting any heating function, the oven will be switched on only after the temperature has been set by the temperature control dial.

Cooking Functions



Bake

This function uses the upper and lower heating elements, creating a natural convection oven. Bake creates a perfect cooking zone in the centre of the oven, ideal for pastry, bread and cakes.



Traditional Bake

This function uses only the lower heating element. It is particularly suitable for quiches, pies and slices that require more cooking on the bottom.



Grill

Use this function to grill or brown small amounts of food. Locate the grill pan in the 4th shelf positions. Pre-heat the grill for 5 minutes before use.



Light

By setting the dial to this position the lighting inside the oven is switched on.

Caution!

At this oven function dial position. The oven is not being warmed up.

BAKING IN THE OVEN

Oven Shelf Guide Levels

Baking pans and accessories (oven grid, baking tray, etc) may be inserted into the oven in any of the 5 guiding levels. Appropriate levels are indicated in the tables that follow. Always count levels from the bottom upwards.

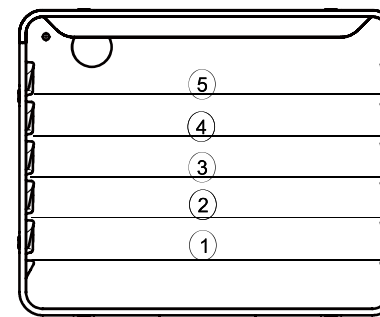

Please note:

The cooking advice given in the following tables is approximate and can be adjusted based on your previous experience and cooking preferences.

If the required cake type is not listed, refer to the one most similar to it.

Baking

Use the bake functions for best results.

Always place the baking dishes onto the wire shelves. Only remove the shelf if baking in the flat biscuit tray supplied with the oven.

Do not put the cake in the oven until it has finished preheating.

Baking tips

Is the cake cooked all the way through?

Pierce the cake with a wooden skewer at the thickest part, if the dough does not stick to it, the cake is cooked all the way through.

Cake has collapsed

Check the recipe. You may need to use smaller quantity of liquid components next time.

Ensure mixing times are followed, especially when using electric mixers, to ensure the right consistency is achieved.

Cake is too light on the bottom

Try baking one level lower next time.

Please note:

The temperature ranges and baking times given in the tables are indicative. We recommend selecting the lower temperature to begin with and increasing it in the later stages of cooking if required.

Baking Table

Food Type	Shelf Level (See Oven Shelf Guide Levels)	Temperature (°C) 	Baking Time (Minutes)
Sweet			
Cheesecake (Tart form)	2	180-190	60-80
Fruit cake	2	190-200	50-70
Sponge cake	2	180-190	30-40
Cherry cake	3	190-210	30-50
Chocolate Cake	2	160-180	50-60
Apple pie	2	190-210	40-60
Puff pastry	2	180-190	20-30
Biscuits	3	180-190	20-30
Danish pastry	3	190-210	20-35
Flaky pastry	3	200-210	20-30
Profiterole	3	190-210	25-45
Savoury			
Bacon roll	2	190-200	45-60
Pizza	2	220-240	30-45
Bread Loaf	2	200-220	50-60
Bread Rolls	2	210-230	30-40
Cooked from Frozen			
Apple pie	2	190-210	50-70
Pizza	2	210-230	20-30
Oven chips	2	210-230	20-35

Grilling

Intensive heat from the infrared element makes the oven and its accessories extremely hot. Use oven gloves and appropriate grilling utensils.

To avoid coming into contact with hot grease which could cause injuries, use long grill tongs when handling the grilled foods.

The grill must be supervised at all times. Excessive heat can quickly burn your food which poses a fire risk.

Do not allow children in the vicinity of the grill when it's in operation.

Grilling is ideal for low-fat sausages, meat, fish fillets and steaks as well as for browning or crisping dishes.

Grilling tips

Please note:

The temperature and grilling times given in the tables are indicative and will vary depending on the type, size and quality of the meat.

Grilling must be carried out with the oven door closed.

Grill element should be preheated for 5 minutes. Oil trays before placing food on it to avoid food sticking to the grid. Place the grid into the oven tray which will catch the dripping fat and juices.

Turn the meat half-way through cooking. Smaller pieces of meat will require just one turn whereas larger pieces of meat may need turning more. Always use appropriate tongs for handling the meat.

Clean the oven and its accessories thoroughly after each use to ensure longevity of your appliance.

Grilling Table

Type of Meat	Weight (Grams)	Shelf Level (See Oven Shelf Guide Levels)	Temperature (°C) 	Grilling Time (Minutes)
Meat and sausages				
2 Beefsteaks (Rare)	400	5	240	14-16
2 Beefsteaks (Medium)	400	5	240	16-20
2 Beefsteaks (Well done)	400	5	240	20-23
2 Pork Chops	400	5	240	20-23
4 Lamb Cutlets	700	5	240	15-18
4 Grill Sausages	400	5	240	9-14
1 Chicken (Halved)	1400	3	240-250	28-33(one side) 23-28(other side)
Fish				
Salmon Fillets	400	4	240	19-22
Fish in aluminium foil	500	4	230	10-13
Toast				
White bread	200	4	240	1.5-3
Wholemeal bread	200	4	240	2-3
Toasted Sandwich	600	4	240	4-7
Meat/Poultry				
Chicken	1000	3	180-200	60-70
Roast Pork	1500	3	160-180	90-120
Roast Beef	1500	3	190-200	40-100

How to use the cooktop zones

The level of heat can be adjusted gradually by turning the appropriate knob to the right or left.

Switching on the zone results in a orange signal light on the control panel turning on.

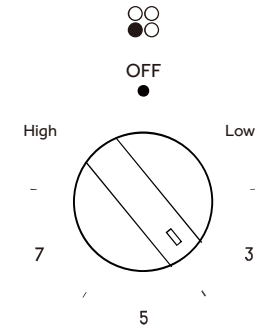

An appropriately selected pan saves energy.

A pan should have a thick, flat base with a diameter equal to the plate diameter, as in that case heat is transferred most efficiently.

Caution!

Ensure the plate is clean - a soiled zone does not transfer all of the heat.

Protect the plate against corrosion.

Switch off the plate before a pan is removed.

Do not leave pans with prepared dishes based on fats and oils unattended on the switched - on plate; hot fat can spontaneously catch fire.

COOKING GUIDELINES - COOKTOP

Choosing the right cookware

- It is important that the bottoms of the pots and pans are the same size as the cooking zone or element.
- Do not use pans with a concave and convex base. A flat base makes better contact with the cooking zone or element, resulting in shorter cooking times.
- Always remember to put a proper cover on the pan.
- We recommend the use of pans with thick and even bases.
- If the heating zones and pans are soiled it is impossible to make full use of the heat.
- Always lift pots and pans off ceramic glass cooktops – do not slide, or they may scratch the cooktop surface.



Heat settings (Cooktop)

The heating zones have different levels of heat. The level of heat can be adjusted gradually by turning the appropriate knob to the right or left. The knob are on the control panel, to select:

-turn the knob clockwise or anticlockwise.

-set to the desired position.

The marks on the knob show the different levels reached by the heating zones.

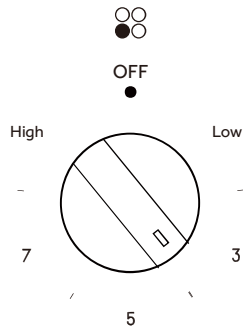

Step	Suitable for
Low	hot plate off, use of remaining heat
2	maintaining temperature, slow cooking, small quantities of food (min power)
3	slow cooking
4-5	slow cooking of large quantities, slow frying of large big chunks
6	frying, preparing soup basis
7-8	fry
High	boiling, browning, frying (maximum power)

CLEANING AND MAINTENANCE

By ensuring proper cleaning and maintenance of your oven you can have a significant influence on the continuing fault-free operation of your appliance.

Before you start cleaning, the oven must be switched off and you should ensure that all knobs are set to the "OFF" position. Do not start cleaning until the oven has completely cooled.

Cleaning the Oven

- The oven should be cleaned after each use.
- Allow the oven to cool completely before carrying out any cleaning or maintenance.
- Steam cleaners must not be used when cleaning this appliance.
- The oven cavity should be cleaned using a mild detergent solution and warm water then wiped dry with a suitable, clean cloth.
- Abrasive cleaning agents or scouring pads/cloths should not be used as they can damage the oven.

Replacing the oven light bulb

Before any maintenance is started involving electrical parts, the appliance must be disconnected from the power supply.

If the oven has been in use, let the oven cavity and the heating elements cool down before attempting any maintenance.

Changing the bulb

1. Unscrew the glass protective cover. Once removed, we recommend washing and drying the cover before replacing it.
2. Carefully remove the old bulb and insert the new bulb suitable for high temperatures having the following specifications: 220-240V/50Hz, 25W, G9 fitting.
3. Replace the protective cover.

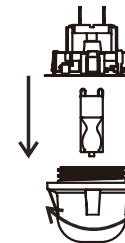

IMPORTANT

- Never use screwdrivers or other utensils to remove the light cover. This could damage the enamel of the oven or the lamp-holder. Remove only by hand.
- Never replace the bulb with bare hands as contamination from your fingers can cause premature failure. Always use a clean cloth or gloves.

PLEASE NOTE

The bulb replacement is not covered by your guarantee/warranty

Storage drawer

Storage drawer runs on telescopic rails, pull from bottom in order to access the compartment. For cleaning the interior enamel surface, wipe out with a soft cloth using a mixture of warm water and mild detergent.

Removing and cleaning the oven door glass

Do not use harsh abrasive cleaners or sharp metal scrapers to clean the oven door glass since they scratch the surface, which may result in shattering of the glass.

The oven door has three panes of glass. To clean these, you need to remove the inner and middle panes as described below:

- Step 1: Unscrew and detach the plastic end caps that are located at the top corners of the door.
- Step 2: Remove the door top profile.
- Step 3: Gently slide the inner glass out.
- Step 4: Unscrew the retaining brackets on both sides of the middle pane.
- Step 5: Gently slide the middle pane out.
- Step 6: Clean the glasses with an appropriate cleaner, dry thoroughly. Place on a soft surface if required.
- Step 7: After cleaning, invert the process above for assembly.

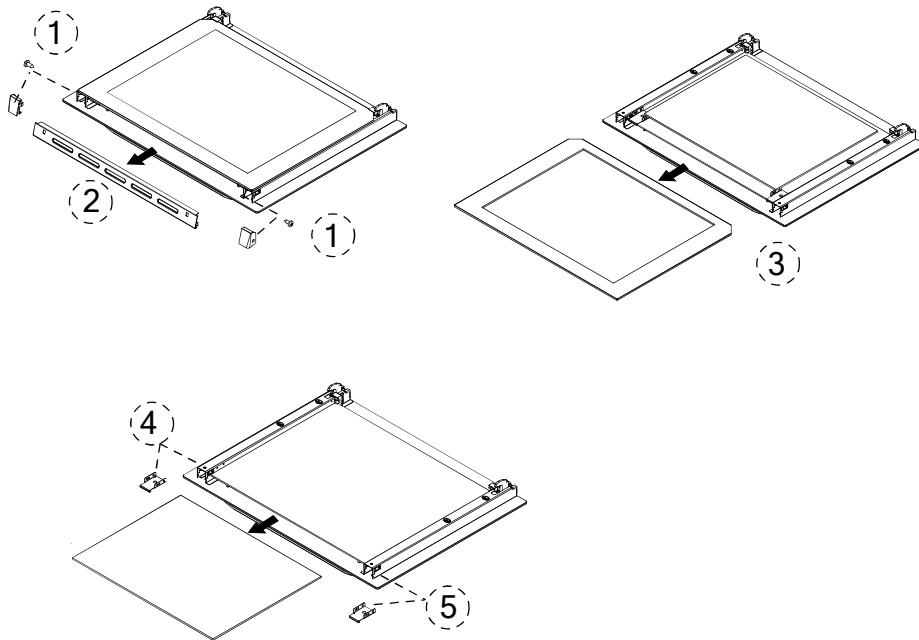

Removing the oven door

In order to obtain easier access to the oven cavity for cleaning, it is possible to remove the door.

- To do this, tilt the safety catch (part of the hinge) upwards.
- Close the door lightly, lift and pull it out towards you.
- In order to fit the door back on to the cooker, do the reverse.
- When fitting, ensure that the notch of the hinge is correctly placed on the protrusion of the hinge holder.
- After the door is fitted to the oven, **the safety catch should be carefully lowered down again.**
- If the safety catch is not set it may cause damage to the hinge when closing the door.

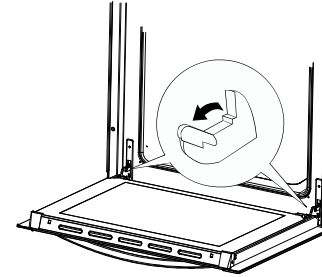

Tilting the hinge safety catches

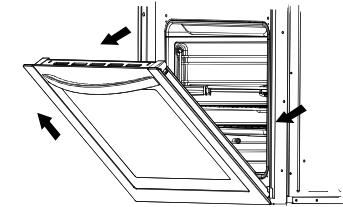

Door removal

IMPORTANT!

Do not place your hands near the hinges while removing or replacing the door. The hinges are spring-loaded and could cause an injury when they snap back.

Regular inspections

Besides keeping the cooker clean, you should:

- Carry out periodic inspections of the control elements and cooking units of the cooker. After the guarantee has expired you should have a technical inspection of the cooker carried out by a serviceman at least once every two years.
- Get any operational faults fixed by an authorized & qualified person.

IMPORTANT!

All repairs and regulatory activities should be carried out by the appropriate service centre or by an appropriately authorized technician.

TROUBLESHOOTING

PROBLEM	POSSIBLE CAUSES	WHAT TO DO
There is a metal sheen on the glass	This could be caused by copper or aluminium-bottomed pots.	Ceramic glass cleaner should remove this. If the cooktop is not cleaned regularly and the stains are allowed to burn onto the surface, they may react with the glass and no longer be removable.
The element keeps turning itself on and off	The element cycling to prevent the glass from overheating. The controller sometimes cycling to maintain your selected heat setting.	This is normal, nothing to do here.
The element keeps turning itself on and off and the cookware isn't heating.	Pots & pans having uneven bases and not making proper contact with glass	Use cookware with smooth bases that sit flat against the glass.
The element status indicator lights (ON, HOT SURFACE) are no longer working		Call your Service Centre. See your Warranty and service book for contact details
The glass is being scratched	Rough-edged cookware Unsuitable, abrasive scourer or cleaning products being used.	Check that your pots/pans have flat, smooth bases. Do not use a heavy-duty scourer to clean the cooktop.
The oven does not work	No power The clock has not been set	Check that the mains power supply (wall switch) is turned on, the fuse has not tripped and there is no power outage in your area. The oven will not work unless the clock is set. See 'Setting the clock'.
The lamp does not come on, but the oven works.	The oven light bulb(s) have blown.	Replace the light bulb(s). See 'Care and cleaning' for instructions.
A glass pane in the oven door has cracked, chipped, or shattered.		You must NOT use the oven. Call your Authorised Repairer or Customer Care.
I can feel hot air blowing out of the vents after I have turned the oven off.	For safety reasons the cooling fans will continue to run even when you have turned the function dial to OFF.	This is normal. The fans will switch off automatically when the oven has cooled.

ENERGY SAVING

Using energy in a responsible way not only saves money but also helps the environment. So let's save energy! And this is how you can do it:

- Use proper pans for cooking. Pans with thick, flat bases can save up to 1/3 on electric energy. Remember to cover pans if possible otherwise you will use four times as much energy!
- Match the size of the saucepan to the surface of the heating plates. A saucepan should never be smaller than a heating plate.
- Ensure heating plates and pan bases are clean. Soils can prevent heat transfer and repeatedly burnt-on spillages can often be removed by products which cause damage to the environment.
- Do not uncover the pan too often (a watched pot never boils!). Do not open the door unnecessarily.
- Only use the oven when cooking larger dishes. Meat of up to 1 kg can be prepared more economically in a pan on the cooker burner.
- Make use of residual heat from the oven. If the cooking time is greater than 40minutes it is recommended to switch off the oven 10 minutes before the end time.
- Only grill with fan function after closing the oven door.
- Make sure the oven door is properly closed.
- Heat can leak through spillages on the door seals. Clean up any spillages immediately.
- Do not install the cooker in the direct vicinity of refrigerators/freezers. Otherwise energy consumption increases unnecessarily.

IMPORTANT!

When using the timer set appropriately shorter cooking times according to the dish being prepared.

TECHNICAL SPECS

Model	HOR60S4CCRW1 HOR60S4CERW1	HOR54S4CCRW1 HOR54S4CERW1
Dimensions (height/width/depth) mm	1140/595/600	1140/540/600
Cooktop		
180mm Hilight heater(kW)	1.8	1.8
145mm Hilight heater(kW)	1.2	1.2
Oven		
Guide levels	5	5
Rear heater(kW)	-	-
Top heater(kW)	0.85	0.85
Bottom heater(kW)	1.15	1.15
Grill heater(kW)	1.1	1.1
Oven illumination(W)	25	25
Function		
Oven light(W)	25	25
Top+bottom heater(kW)	2.0	2.0
Top heater+grill(kW)	1.95	1.95
Bottom heater(kW)	1.15	1.15
Temperature	50–250°C	50–250°C
Frequency(Hz)	50	50
Electrical Input(V)	220-240V/ 380-415V 3N~	220-240V/ 380-415V 3N~
Oven power(kW)	2.0	2.0
Hotplate power(kW)	6.0	6.0
Oven+Hobs Power(kW)	8.0	8.0
Total Power(kW)	10.0	10.0

MANUFACTURER'S WARRANTY

Please read this warranty card carefully. Attach your purchase receipt to this warranty card and keep in a safe place. You must produce both warranty card and proof of purchase in the event of a warranty repair being required.

When you purchase any new Haier Product you automatically receive a two year Manufacturer's Warranty covering parts and labour for servicing.

The Manufacturer undertakes to:

Repair or, at its option, replace without cost to the owner either for material or labour any part of the Product, the serial number of which appears on the Product, which is found to be defective within TWO YEARS from the date of purchase.

This warranty DOES NOT cover:

- A** Service calls which are not related to any defect in the Product. The cost of a service call will be charged if the problem is not found to be a Product related fault. For example:
 1. Correct the installation of the product.
 2. Provide Instruction on use of the product or change the setup of the product.
 3. Replace house fuses or correct house wiring.
 4. Correcting fault(s) caused by the user.
 5. Noise or vibration that is considered normal.
 6. Water on the floor due to incorrect loading or excessive suds.
 7. Blocked pumps, removal of foreign objects/substances from the machine, including the pump and inlet house filters.
 8. Correcting damage caused by pests, eg. rats, cockroaches etc.
 9. Correct corrosion or discolouration due to chemical attack.
 10. Power outages or surges
- B** Defects caused by factors other than:
 1. Normal domestic use or
 2. Use in accordance with the Product's User Guide.
- C** Defects to the Product caused by accident, neglect, misuse or 'Act of God'.
- D** The cost of repairs carried out by non-authorized repairers or the cost of correcting such unauthorised repairs.
- E** Normal recommended maintenance as set out in the Product's User Guide.
- F** Repairs when the appliance has been dismantled, repaired or serviced by other than an AUTHORISED CUSTOMER SERVICE CENTRE or the selling dealer.
- G** Pick up and delivery.
- H** Transportation or travelling costs involved in the repair when the product is installed outside the AUTHORISED CUSTOMER SERVICE CENTRE'S normal service area.

This product has been designed for use in a normal domestic environment. It is not intended for commercial use. Doing so may affect product warranty. Service under this warranty must be provided by an Authorised Service Repairer (refer to the Customer Care section for contact details). Such service shall be provided during normal business hours. This warranty certificate should be shown when making any claim.

Note:

This Warranty is an extra benefit and does not affect your legal rights and applies only to product purchased in New Zealand and Australia. Please keep this Warranty Card in a safe place.

For Australian customers:

Our goods come with guarantees that cannot be excluded under the Australian Consumer Law. You are entitled to a replacement or refund for a major failure and for compensation for any other reasonably foreseeable loss

CUSTOMER CARE

Check the things you can do yourself. Refer to your User Guide and check:

1. Your appliance is correctly installed.
2. You are familiar with its normal operation.
3. You have read the problem solving section in your User Guide.

If after checking these points you still need assistance, please refer to your nearest Haier Authorised Repairer.

In New Zealand, if you need assistance...*

Call your retailer who is trained to provide information on your appliance, or if we can be of any further help, please contact our Customer Care Centre:

Toll Free: 0800 372 273 Fax: (09) 273 0656
Email: customer.care@haier.co.nz
Postal address: P.O. Box 58732, Botany, Manukau 2163

If you need service...*

We have a network of independent Fisher & Paykel Authorised Repairers whose fully trained technicians can carry out any service necessary on your appliance. Your dealer or our Customer Care Centre can recommend a Fisher & Paykel Authorised Repairer in your area.

In Australia, if you need assistance...*

Call the Customer Care Centre and talk to one of our Customer Care Consultants.

Toll Free: 1300 729 948 Fax: (07) 3826 9298
Email: customer.care@haierlife.com.au
Postal Address: PO Box 798, Cleveland QLD 4163

If you need service...*

We have a network of qualified Authorised Repairers whose fully trained technicians can carry out any service necessary on your appliance. Our Customer Care Centre can recommend an Authorised Repairer in your area.

*If you call or write, please provide: name, address, model number, serial number, date of purchase and a description of the problem. This information is needed in order to better respond to your request for assistance.

Product Details

Model _____ Serial No. _____

Date of

Purchase _____ Purchaser _____

Dealer _____

Suburb _____

Town _____

Country _____

Thank you for choosing Haier. We are confident that you will enjoy many years of good service from your appliance.