

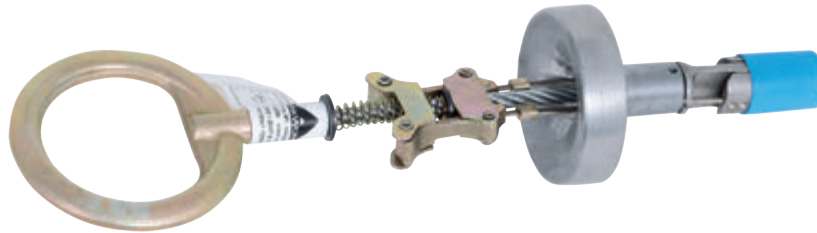

## CONCRETE HOLE ANCHOR INSTRUCTION MANUAL

Prod. No. V8222120  
Mod. No. CP-12010-1



### WARNING!

These instructions must be read and understood by all persons using this device. Improper use could result in serious injury or death. This product must be used in strict compliance with local, state and federal OSHA regulations. All users should have training and instruction at routine intervals. This device is to be used only with ANSI & OSHA compliant fall arrest systems. This device must be installed per provided instructions and must be inspected before and after each use. If this device is subjected to a fall or other damaging incident it must be removed from service and destroyed per instructions.

### REQUIREMENTS & SPECIFICATIONS

- Follow all manufacturer's instructions.
- **For FALL PROTECTION ONLY.**
- For use in concrete substrate only.
- DO NOT use in wet/uncured concrete.
- Concrete must have 3000 psi minimum compressive strength.
- Always inspect prior to use.
- For use by qualified fall protection personnel only.
- Use only compatible connectors, snap hooks or carabiners with this unit.
- This unit is not to be used for any other anchoring situation.
- Anchor rated @ 5,000 lb for single user up to 310 lb.
- DO NOT use in steel, wood or any substrate other than concrete.

### INSPECTION

- Make sure unit is straight and operates smoothly.
- Make sure the Tag is affixed to unit.
- Make sure the Retractor Handle is not bent or damaged.
- Make sure Retractor Cables are not kinked, frayed or damaged.
- Make sure metal components are not damaged.
- Make sure Chocks and Wedge operate smoothly, and no metal burrs occur.
- When reusing a previously drilled hole, always inspect the hole carefully.

### STORAGE & CLEANING

- Blow off unit after each use with compressed air.
- Store in clean dry environment.
- Store in secure locked area.
- Store and put away at the end of each day's work.
- Do not pile any objects on top of unit during storage.
- Keep unit free of grease, oils and dirt.
- Never lend unit to other workers.

### DISPOSAL

- Dispose of unit after any fall has occurred.
- Dispose of unit if any cable becomes kinked or frayed.
- Dispose of unit if Retractor Handle, Stop Ferrule or Wedge is bent or damaged.
- Dispose of unit if retractor action is rough or sticky.
- Proper disposal requires that both Chocks are cut off from the Retractor Cables and all parts thrown away.

### HOLE DRILLING & PLACEMENT REQUIREMENTS:

- Anchor holes must be drilled using only industrial grade 3/4" rotary hammer drill bits and a rotary hammer drill.
- **NEVER USE A BENT DRILL BIT.**
- Hole must be drilled (bored) straight and parallel and free of any peaks or valleys on the inner wall.
- Hole must be a minimum depth of 3" into the substrate.
- Hole must be cleaned with compressed air to remove any drilling debris.
- When reusing a previous hole, inspect carefully for debris and uniform surface. If necessary drill another proper hole.
- If concrete is 12" thick x 12" wide (or more) the hole must be at least 6" from any edge or corner.
- If concrete is 10" thick x 16" wide (or more) the hole must be at least 8" from any edge or corner.
- If concrete is 8" thick x 20" wide (or more) the hole must be at least 10" from any edge or corner.
- If concrete is 5" thick (or more) the hole must be at least 12" from any edge or corner.

### MAKE SURE THIS TAG IS AFFIXED TO THE UNIT

**INSTALLATION**

**STEP 1**

Place thumb through the Ring and pull up on the Retractor Handle to retract the Chocks.

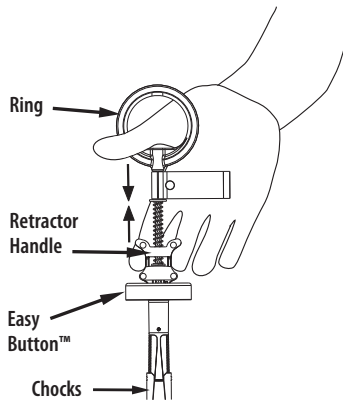

**STEP 2**

Insert the anchor into the hole until the Easy Button™ seats against the hole face. Keep the Retractor Handle level while slowly releasing.

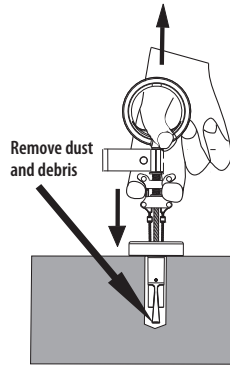

**STEP 3**

Set anchor by pulling on the Ring as hard as desired.

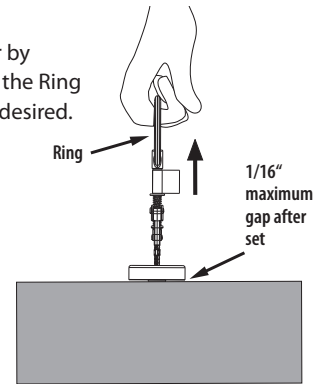

**CAUTION:**

Be sure the Retractor Handle is level to prevent kinked Retractor Cables.

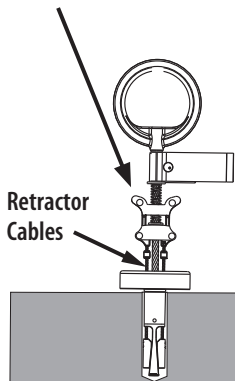

**CORRECT**

**INCORRECT:**

Using like this will cause kinked Retractor Cables and ruin the Hole Anchor!

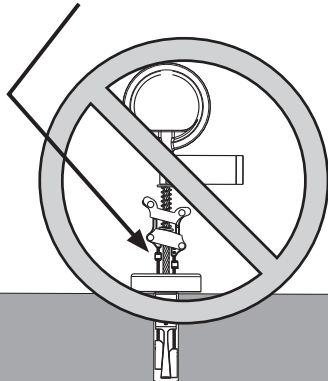

**INCORRECT**

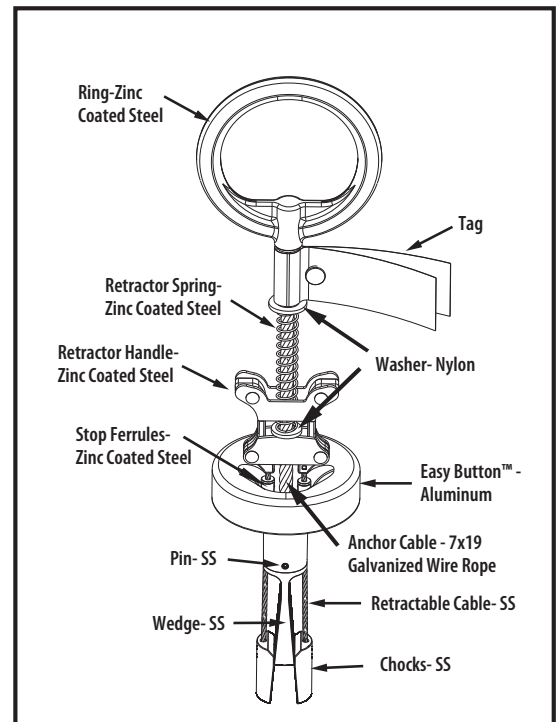

**REMOVAL:**

**STEP 1**

To release, push the Easy Button™ with both thumbs or palms to unlock the Chocks. If the anchor does not release, tap the Easy Button™ with any handy object.

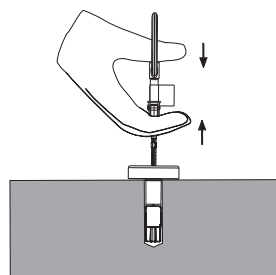
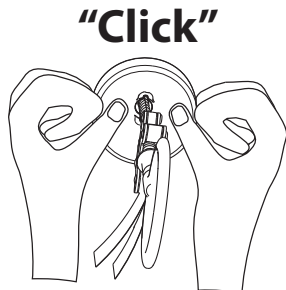

**STEP 2**

Then retract the Handle and remove the anchor from the hole.

**WARRANTY**

SureWerx products are warranted against factory defects in workmanship and materials for a period of two years from date of installation or use by the owner, provided that this period shall not exceed two years from the date of shipment. Upon notice in writing, SureWerx will promptly repair or replace all defective items. SureWerx reserves the right to elect to have any defective item returned to its plant for inspection before making a repair or replacement. This warranty does not cover equipment damages resulting from abuse, damage in transit, or other damage beyond the control of SureWerx. This warranty applies only to the original purchaser and is the only one applicable to our products, and is in lieu of all other warranties, expressed or implied.