

# Environmental Product Declaration



In accordance with ISO 14025 and EN 15804:2012+A2:2019 for:

## Linear Floor Drain - Highline Frame and Panel

from

**Unidrain A/S**



Programme  
 Programme operator  
 EPD registration number  
 Version date:  
 Valid until:

EPD International AB  
 The International EPD® System  
 EPD IES 0017904  
 2024 12 16  
 2029 12 15

This EPD covers multiple products and based on results of representative product. An EPD should provide current information and may be updated if conditions change. The stated validity is therefore subject to the continued registration and publication at [www.environdec.com](http://www.environdec.com)

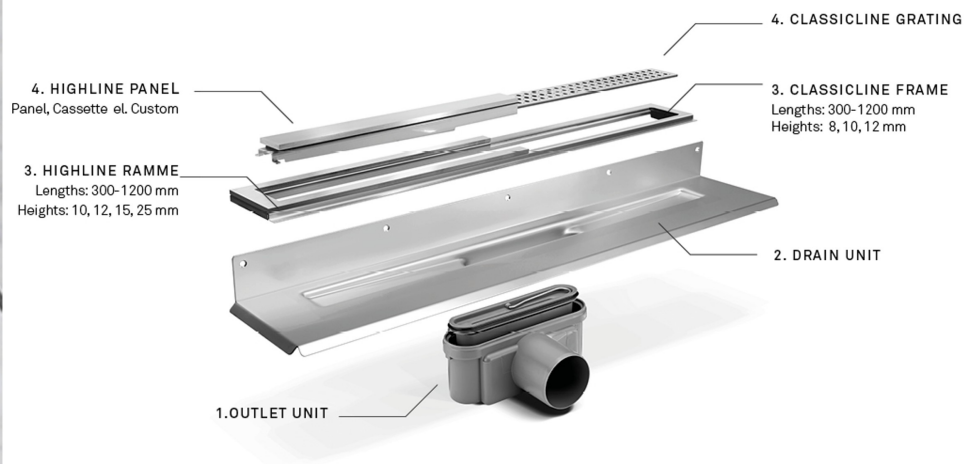

## General Information

Programme information	
Programme	The International EPD® System
Address:	EPD International AB Box 210 60 SE-100 31 Stockholm Sweden
Website	www.environdec.com
E-mail	info@environdec.com

Accountabilities for PCR, LCA and independent, third-party verification	
Product Category Rules (PCR)	Construction products (EN 15804:A2) PCR 2019:14 Construction products (EN 15804:A2) (1.3.4)
Life Cycle Assessment (LCA)	Carbonzero AB
Third-party verification:	<p>Independent third-party verification of the declaration and data, according to ISO 14025:2006:</p> <p><input checked="" type="checkbox"/> EPD process certification</p> <p>Vladimír Kocí, LCA Studio</p> <div style="border: 1px dashed black; padding: 5px; display: inline-block;">  </div> <p>Approved by: The International EPD® System</p>
Procedure for follow-up of data during EPD validity involves third party verifier: <input type="checkbox"/> Yes <input checked="" type="checkbox"/> No	

The EPD owner has the sole ownership, liability, and responsibility for the EPD.

EPDs within the same product category but registered in different EPD programmes, or not compliant with EN 15804, may not be comparable. For two EPDs to be comparable, they must be based on the same PCR (including the same version number) or be based on fully-aligned PCRs or versions of PCRs; cover products with identical functions, technical performances and use (e.g. identical declared/functional units); have equivalent system boundaries and descriptions of data; apply equivalent data quality requirements, methods of data collection, and allocation methods; apply identical cut-off rules and impact assessment methods (including the same version of characterisation factors); have equivalent content declarations; and be valid at the time of comparison. For further information about comparability, see EN 15804 and ISO 14025.

**Company information**

Owner of the EPD	Unidrain A/S
Contact	Product Manager - Jacob Honoré
Description of the organisation	Unidrain is a part of BLS Industries AB. Main markets are Nordic countries but with an export organization. BLS Industries AB is a family-owned company with own production, product development, sales etc. Mainly operating in the plumbing business. Based in Ystad Sweden production units also in Smålandsstenar and Lönsboda, Sweden.
Product-related or management system-related certifications:	EN ISO 9001:2015    EN ISO 14001:2015
Name and location of production site(s):	<b>Name of plant:</b> BLS Industries <b>Location:</b> Ystad, Sweden

**Product information**

Product name(s)	0900 Highline (frame + steel panel)
Product description:	Unidrain Linear floor drain is used in indoor drainage. The system includes a drain unit and an outlet unit, both installed in the floor construction, and two visual design series, placed in the tile layer (Classicline and Highline). <p style="text-align: right;">Drain units:</p> Four main versions (1001, 1002, 1003, 1004) with different lengths (300 to 1200 mm). Outlet units: Various dimensions and directions for different piping applications. Classicline: Frame and grating. Highline: Options include a frame with a steel panel, a frame with a cassette, and a custom panel (for tile).
RSL	N/A years
UN CPC code	412 - Products of iron or steel

**LCA information**

Functional unit / declared unit	1 kg of product
Time representative-ness	Data obtained refers to the year 2023
System Boundary	The system boundaries are set to be "cradle-to-gate" with modules A4, C1-C4 and D.
Database(s) and LCA software used	Eando X version 1.01

System diagram

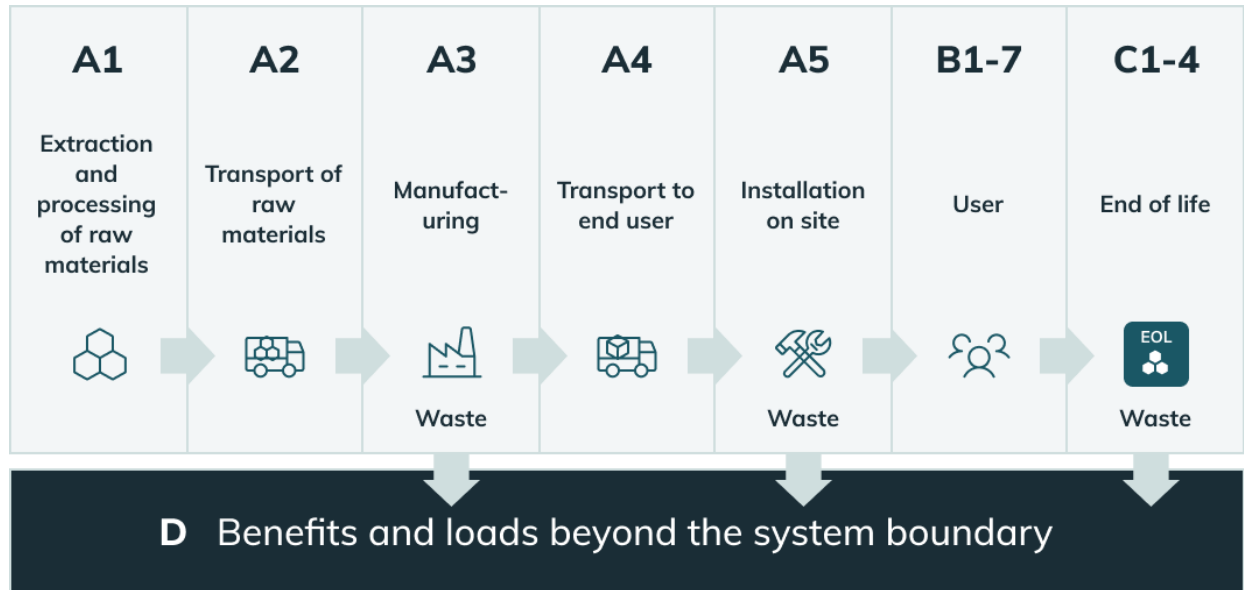

A1	Raw material supply	This module considers the extraction and processing of all raw materials, energy, and transportation which occur upstream to the studied manufacturing process, including packaging material.
A2	Transport to the manufacturer	The raw materials are transported to the manufacturing site.
A3	Manufacturing*	This module includes all resources used to produce and waste produced. This also includes additives and packaging material.
A4	Transport	Transportation from the manufacturing site to distribution centre and then from the distribution centre to the building site is included.
	Transport Scenario	truck: 600km
A5	Construction installation	This stage is not declared except for GWP-biogenic arising from packaging that exits the system boundary was balanced in this module.
B1-B7	Use stage	This stage is not declared.
C1	Deconstruction/Demolition	This stage includes the de-construction and/or demolition of the building. This is not relevant as the product included in this study is not used in the construction process.
C2	Transport	This stage represents the transport distance to the waste processing facility.
C3	Waste processing	This stage includes any waste treatment needed.
	EOL Scenario	Landfill 9.08%. Incineration 4.83%. Recycling 86.08%.
C4	Final disposal	This includes any material that is landfilled.
D	Benefits	Emission credits obtained from energy recovery and/or recycling materials

Unidrain’s products consist of components made from various materials, such as stainless steel, plastic, and rubber. The steel components are produced using a variety of manufacturing processes: stamping, laser cutting, and deep drawing. Plastic and rubber components are produced using injection molding. Individual components are then assembled, and final products are made ready for shipping. All products considered for the study are manufactured by BLS Industries and shipped to their customers.

**Modules declared, geographical scope, share of specific data (in GWP-GHG results) and data variation (in GWP-GHG results):**

	Product stage			Assembly stage		Use stage							End of life stage				Benefits & loads beyond system boundary
	Raw Materials	Transport	Manufacturing	Transport	Assembly	Use	Maintenance	Repair	Replacement	Refurbishment	Operational energy use	Operational water use	De-construction demolition	Transport	Waste processing	Disposal	
	A1	A2	A3	A4	A5*	B1	B2	B3	B4	B5	B6	B7	C1	C2	C3	C4	D
Declared	X	X	X	X	ND	ND	ND	ND	ND	ND	ND	ND	X	X	X	X	X
Geography	EU	EU	SE	EU	-	-	-	-	-	-	-	-	EU	EU	EU	EU	EU
Specific data used	13,8 %			-	-	-	-	-	-	-	-	-	-	-	-	-	-
Variation-Products	< 10 %			-	-	-	-	-	-	-	-	-	-	-	-	-	-
Variation-Sites	0 %			-	-	-	-	-	-	-	-	-	-	-	-	-	-

ND – Not Declared; X – Declared

Reading example: 9,0E-03 =  $9,0 \cdot 10^{-3} = 0,009$

\* Module A5 is only partially declared, GWP biogenic arising due to packaging material in A1-A3 stages are balanced in A5 where it exits the product system boundary.

## Content Information

Product Components	Weight, kg	Post-consumer material, weight-%	Biogenic material, weight-% and kg C/kg
Metal	0.885	0.770	0.000
Plastic	0.103	0.000	0.000
Minerals	0.005	0.000	0.000
Rubber	0.004	0.000	0.000
Polymer	0.002	0.000	0.000
Total	1.000	0.682	0.000

Packaging Materials	Weight, kg	Weight-% (versus the product)	Weight biogenic carbon, kg C/kg
Paper board	0.107	10.684	0.043
Packaging Paper	0.014	1.404	0.006
Polypropylene (PP)	4.43e-4	0.044	0.000
Isopropanol	7.39e-4	0.074	0.000
Polyethylene (PE)	1.48e-4	0.015	0.000
Plastic wrapping (PP film)	0.006	0.562	0.000
Polyolefin (OEM/POF)	4.43e-4	0.044	0.000
Total	0.128	12.826	0.049

Dangerous substances from the candidate list of SVHC for Authorisation	EC No.	CAS No.	Weight-% per functional or declared unit
-	-	-	0.000

At the date of issue of this declaration, there is no "Substance of Very High Concern" (SVHC) in concentration above 0.1% by weight, and neither does the packaging, following the European REACH regulation (Registration, Evaluation, Authorization and Restriction of Chemicals)

# Environmental Information

Potential environmental impact – indicators according to EN 15804+A2

Results per functional unit: 1 kg									
Indicator	Unit	A1 - A3	A4	A5	C1	C2	C3	C4	D
GWP-total	kg CO2 eq	4.63e+0	5.40e-2	1.78e-1	0.00e+0	4.50e-3	7.81e-2	1.18e-1	-2.46e+0
GWP-fossil	kg CO2 eq	4.79e+0	5.29e-2	ND	0.00e+0	4.41e-3	6.34e-2	1.18e-1	-2.45e+0
GWP-biogenic	kg CO2 eq	-1.61e-1	1.70e-4	1.78e-1	0.00e+0	1.42e-5	1.46e-2	3.95e-5	-7.81e-3
GWP-luluc	kg CO2 eq	5.84e-3	9.00e-4	ND	0.00e+0	7.50e-5	1.34e-4	2.13e-5	-2.22e-3
ODP	kg CFC-11 eq	7.06e-9	7.86e-15	ND	0.00e+0	6.55e-16	8.00e-10	5.38e-14	-2.65e-10
AP	mole H+ eq	3.13e-2	3.39e-4	ND	0.00e+0	2.82e-5	3.77e-4	3.08e-5	-1.64e-2
EP-freshwater*	kg P eq	1.39e-4	2.28e-7	ND	0.00e+0	1.90e-8	1.24e-5	4.69e-8	-1.00e-5
EP-marine	kg N eq	3.82e-3	1.66e-4	ND	0.00e+0	1.38e-5	1.39e-4	8.37e-6	-1.64e-3
EP-terrestrial	mole N eq	4.15e-2	1.84e-3	ND	0.00e+0	1.53e-4	1.29e-3	1.15e-4	-1.82e-2
POCP	kg NMVOC eq	1.18e-2	3.28e-4	ND	0.00e+0	2.74e-5	4.13e-4	2.50e-5	-5.42e-3
ADP-minerals & metals**	kg Sb eq	1.71e-4	4.65e-9	ND	0.00e+0	3.88e-10	4.81e-7	6.25e-10	-9.70e-5
ADP-fossil**	MJ	6.67e+1	7.02e-1	ND	0.00e+0	5.85e-2	8.33e-1	1.32e-1	-3.30e+1
WDP**	m3	9.57e-1	8.28e-4	ND	0.00e+0	6.90e-5	1.05e-2	1.14e-2	-4.32e-1
Acronyms	GWP-fossil = Global Warming Potential fossil fuels; GWP-biogenic = Global Warming Potential biogenic; GWP-luluc = Global Warming Potential land use and land use change; ODP = Depletion potential of the stratospheric ozone layer; AP = Acidification potential, Accumulated Exceedance; EP-freshwater = Eutrophication potential, fraction of nutrients reaching freshwater end compartment; EP-marine = Eutrophication potential, fraction of nutrients reaching marine end compartment; EP-terrestrial = Eutrophication potential, Accumulated Exceedance; POCP = Formation potential of tropospheric ozone; ADP-minerals&metals = Abiotic depletion potential for non-fossil resources; ADP-fossil = Abiotic depletion for fossil resources potential; WDP = Water (user) deprivation potential, deprivation-weighted water consumption								

\* The results in kg PO4 eq. can be obtained by multiplying the results in kg P eq. by a factor of 3,07.

\*\* The results of this environmental impact indicator shall be used with care as the uncertainties on these results are high or as there is limited experience with the indicator.

## Use of resources

Results per functional unit: 1 kg									
Indicator	Unit	A1 - A3	A4	A5	C1	C2	C3	C4	D
PERE	MJ	2.53e+1	6.06e-2	ND	0.00e+0	5.05e-3	3.73e-2	3.01e-2	-8.12e+0
PERM	MJ	1.50e+0	0.00e+0	ND	0.00e+0	0.00e+0	0.00e+0	0.00e+0	0.00e+0
PERT	MJ	2.68e+1	6.06e-2	ND	0.00e+0	5.05e-3	3.73e-2	3.01e-2	-8.12e+0
PENRE	MJ	4.54e+1	7.02e-1	ND	0.00e+0	5.85e-2	7.41e-1	1.32e-1	-3.07e+1
PENRM	MJ	3.34e+0	0.00e+0	ND	0.00e+0	0.00e+0	-1.55e+0	-8.51e-1	-5.23e-1
PENRT	MJ	4.88e+1	7.02e-1	ND	0.00e+0	5.85e-2	-8.13e-1	-7.20e-1	-3.12e+1
SM	kg	8.13e-3	0.00e+0	ND	0.00e+0	0.00e+0	0.00e+0	0.00e+0	3.50e-2
RSF	MJ	0.00e+0	0.00e+0	ND	0.00e+0	0.00e+0	0.00e+0	0.00e+0	0.00e+0
NRSF	MJ	0.00e+0	0.00e+0	ND	0.00e+0	0.00e+0	0.00e+0	0.00e+0	0.00e+0
FW	m <sup>3</sup>	1.98e-2	6.78e-5	ND	0.00e+0	5.65e-6	2.44e-4	2.77e-4	-1.24e-2
Acronyms	PERE = Use of renewable primary energy excluding renewable primary energy resources used as raw materials; PERM = Use of renewable primary energy resources used as raw materials; PERT = Total use of renewable primary energy resources; PENRE = Use of non-renewable primary energy excluding non-renewable primary energy resources used as raw materials; PENRM = Use of non-renewable primary energy resources used as raw materials; PENRT = Total use of non-renewable primary energy re-sources; SM = Use of secondary material; RSF = Use of renewable secondary fuels; NRSF = Use of non-renewable secondary fuels; FW = Use of net fresh water								



## Additional voluntary indicators

Results per functional unit: 1 kg									
Indicator	Unit	A1 - A3	A4	A5	C1	C2	C3	C4	D
GWP-GHG	kg CO2 eq	4.83e+0	5.40e-2	ND	0.00e+0	4.50e-3	7.88e-2	1.18e-1	-2.46e+0
EP	kg PO4 eq	9.57e-4	0.00e+0	ND	0.00e+0	0.00e+0	2.10e-5	1.19e-6	-6.76e-4
Acronyms	GWP-GHG global warming potential - greenhouse gases; EP eutrophication potential								

The GWP-GHG indicator is identical to GWP-total except that the characterisation factor (CF) for biogenic CO2 is set to zero. This means that the uptake and emissions of biogenic CO2 are “balanced out” already in modules A1-A3, instead of in modules A1-A5 (for packaging) or modules A-C (for product). In the context of Norwegian public procurement legislation, GWP-GHG is also referred to as GWP-IOBC.

## Waste and output flows

Results per functional unit: 1 kg									
Indicator	Unit	A1 - A3	A4	A5	C1	C2	C3	C4	D
HWD	kg	1.30e-7	2.69e-11	ND	0.00e+0	2.24e-12	0.00e+0	5.91e-11	-5.09e-8
NHWD	kg	4.21e-1	1.15e-4	ND	0.00e+0	9.55e-6	2.86e-2	1.37e-1	-3.10e-1
RWD	kg	8.98e-4	1.28e-6	ND	0.00e+0	1.07e-7	0.00e+0	3.24e-6	-8.60e-4
Acronyms	HW Hazardous waste disposed; NHW Non-hazardous waste disposed; RW Radioactive waste disposed								

## Output flows

Results per functional unit: 1 kg									
Indicator	Unit	A1 - A3	A4	A5	C1	C2	C3	C4	D
CRU	kg	0.00e+0	0.00e+0	ND	0.00e+0	0.00e+0	0.00e+0	0.00e+0	0.00e+0
MFR	kg	1.68e-1	0.00e+0	ND	0.00e+0	0.00e+0	8.61e-1	0.00e+0	0.00e+0
MER	kg	3.57e-2	0.00e+0	ND	0.00e+0	0.00e+0	1.81e-2	0.00e+0	0.00e+0
EEE	MJ	0.00e+0	0.00e+0	ND	0.00e+0	0.00e+0	0.00e+0	0.00e+0	0.00e+0
EET	MJ	0.00e+0	0.00e+0	ND	0.00e+0	0.00e+0	0.00e+0	0.00e+0	0.00e+0
Acronyms	CRU Components for reuse; MFR Materials for recycling; MER Materials for energy recovery; EEE Exported electric energy; ETE Exported thermal energy								

## Product Table

Name	Weight, kg	Unit
0300 Highline (frame + steel panel)	2.815	pc
0700 Highline (frame + steel panel)	5.392	pc
0800 Highline (frame + steel panel)	6.087	pc
0900 Highline (frame + steel panel)	6.767	pc
1000 Highline (frame + steel panel)	7.464	pc
1200 Highline (frame + steel panel)	8.854	pc

# Energy Breakdown

Breakdown of energy usage

Name	Value	Unit
Electricity Mix - BLS Industries (2023)	1.60E-01	kg CO2 -eq/kWh

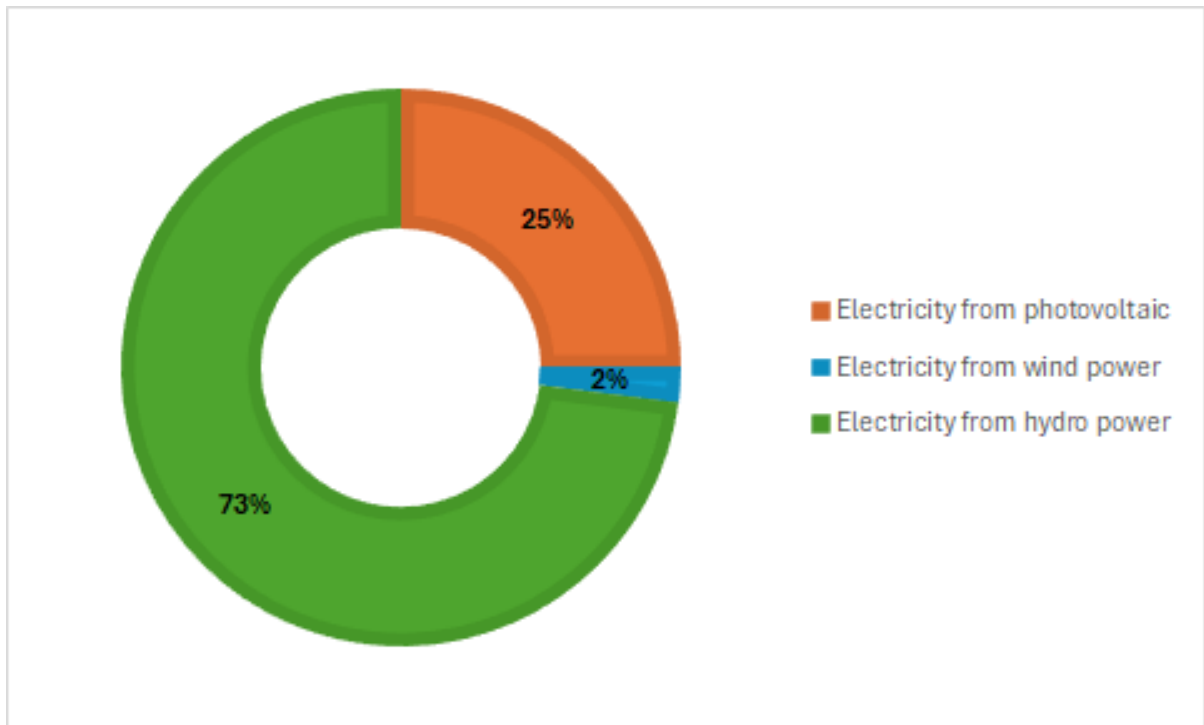

## Additional information

### Additional Environmental Information

See the PCR and sections 5.4, 7.3 and 7.4 in EN 15804.

An EPD may include additional environmental information, in addition to the LCA results of the section on environmental performance results. The additional environmental information may cover various aspects of specific relevance for the product, for example:

- instruction for proper use of the product, e.g. to minimise the energy or water consumption or to improve the durability of the product;
- instructions for proper maintenance and service of the product;
- information on key parts of the product determining its durability;
- information on recycling including e.g. suitable procedures for recycling the entire product or selected parts and the potential environmental benefits gained;
- information on a suitable method of reuse of the product (or parts of the products) and procedures for disposal as waste at the end of its life cycle,
- information regarding disposal of the product or inherent materials, and any other information considered necessary to minimise the product's end-of-life impacts,
- information on permanent (more than 100 years) storage of biogenic carbon, either in the product, in a landfill, or as a consequence of applying carbon capture and storage (CCS) to the incineration of biogenic carbon, and how this would influence GWP-biogenic results if the GWP-biogenic indicator would allow consideration of such storage (it currently does not according to EN 15804; in case of such storage a virtual emission of biogenic CO<sub>2</sub> has to be added, see Annex 2)
- a more detailed description of an organisation's overall environmental work such as:
  - the existence of a quality or environmental management system or any type of organised environmental activity, and
  - information on where interested parties may find more details about the organisation's environmental work.

Additional environmental information can also include information on carbon offset, carbon storage and delayed emissions, or on release of dangerous substances to indoor air, soil and water during the use stage.

### Additional social and economic information





The EPD may also include other relevant social and economic information as additional and voluntary information. This may be product information or a description of an organisation's overall work on social or economic sustainability, such as activities related to supply chain management or social responsibility.

Any additional social and economic information declared shall be substantiated and verifiable, and be derived using appropriate methods and be specific, accurate, not misleading, and relevant to the specific product. Quantitative information is preferred over qualitative information.

## References

EN 15804:2012+A2	Sustainability of construction works: Environmental product declaration – Core rules for the product category of construction products
EPD International (2021)	General Programme Instructions of the International EPD® System, version 4.0
EPD International (2024)	PCR 2019:14. Construction products and construction services (EN 15804: A2) v1.3.4.
ISO 14020:2000	Environmental labels and declarations: General principles
ISO 14025:2006	International Standard ISO 14025: Environmental labels and declarations — Type III environmental declarations — Principles and procedures
ISO 14040:2006	International Standard ISO 14040: Environmental Management – Life cycle assessment – Principles and framework. Second edition 2006-07-01.
ISO 14044:2006	International Standard ISO 14044: Environmental Management – Life cycle assessment – Requirements and Guidelines.
SCB (2023)	<a href="https://www.statistikdatabasen.scb.se/pxweb/en/ssd/START_MI_MI0305/MI0305T003/table/tableViewLayout1/">https://www.statistikdatabasen.scb.se/pxweb/en/ssd/START_MI_MI0305/MI0305T003/table/tableViewLayout1/</a> Accessed 2024-02-03
Association of Issuing Bodies	European Residual Mixes 2021 (2022) <a href="https://www.aib-net.org/sites/default/files/assets/facts/residual-mix/2021/AIB_2021_Residual_Mix_Results_1_1.pdf">https://www.aib-net.org/sites/default/files/assets/facts/residual-mix/2021/AIB_2021_Residual_Mix_Results_1_1.pdf</a> (Retrieved 2023-09-20)
Searates (2024)	<a href="https://www.searates.com/services/distances-time/">https://www.searates.com/services/distances-time/</a> (Accessed 2024-02-03) Accessed 2024-02-03
EPD International (2024)	General Programme Instructions of the International EPD® System, version 5.0

## Contact Info

EPD owner:	 Unidrain A/S Email: <a href="mailto:jho@unidrain.dk">jho@unidrain.dk</a> Telephone: +45 51542107 Address: Ejby Industrivej 40, DK-26000 Denmark
LCA author:	 Carbonzero AB Email: <a href="mailto:info@eando.se">info@eando.se</a> Telephone: +46 4 317 07 07 Address: SE-262 32 Ängelholm, Sweden
Third party verifier:	 Vladimír Kocí Email: <a href="mailto:vladimir.koci@lcastudio.cz">vladimir.koci@lcastudio.cz</a> Telephone: +420 608 055 972 Address: LCA Studio, Šárecká 1962/5, 160 00 Praha 6
Program operator:	 EPD International AB Email: <a href="mailto:info@environdec.com">info@environdec.com</a> Telephone: +46 (0)73 311 30 20 Address: SE-11427 Stockholm, Sweden