

This document must not be copied without our written permission, and the contents thereof must not be imported to a third party nor be used for any unauthorized purpose. Contravention will be prosecuted. Purus AB

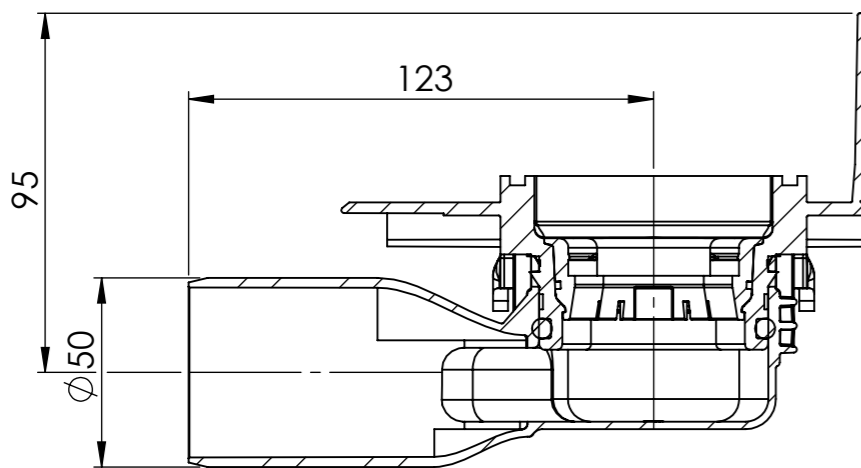

SECTION A-A
SCALE 1 : 2

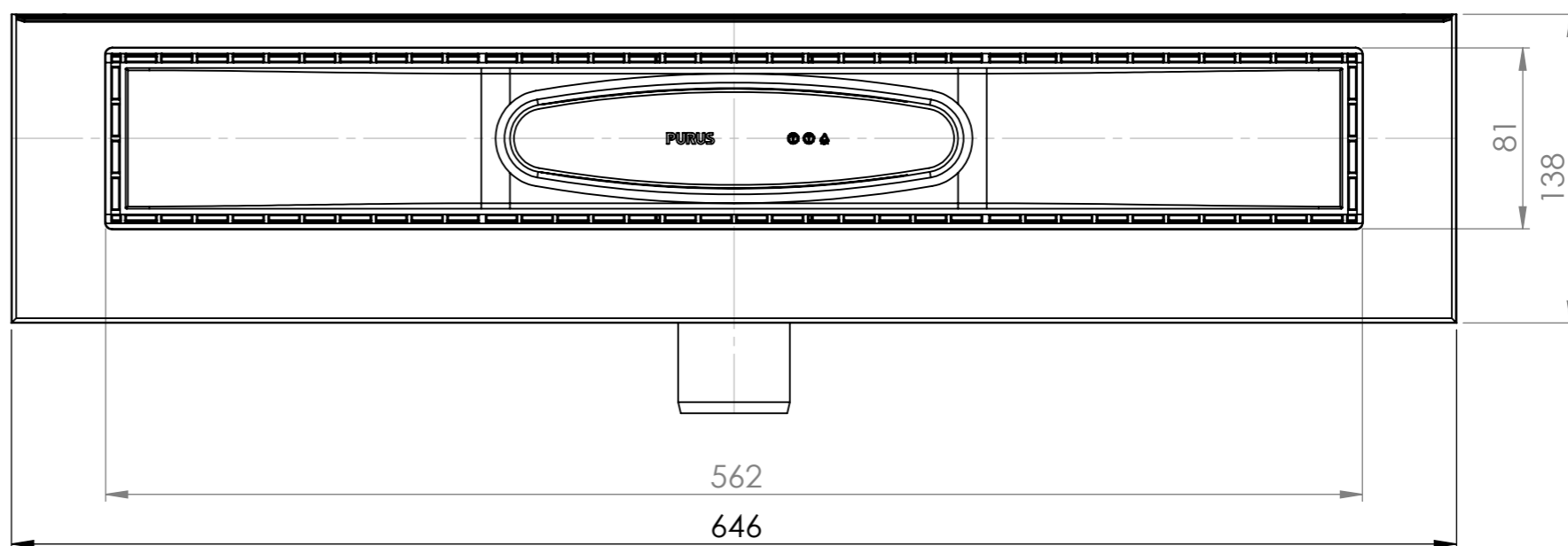
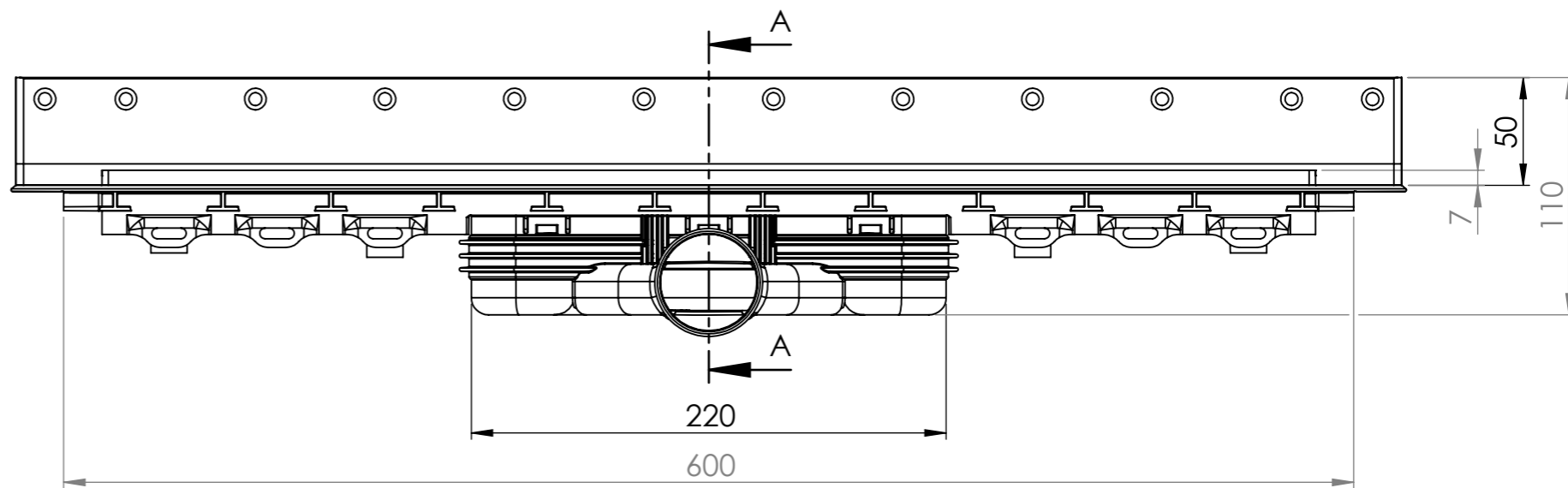
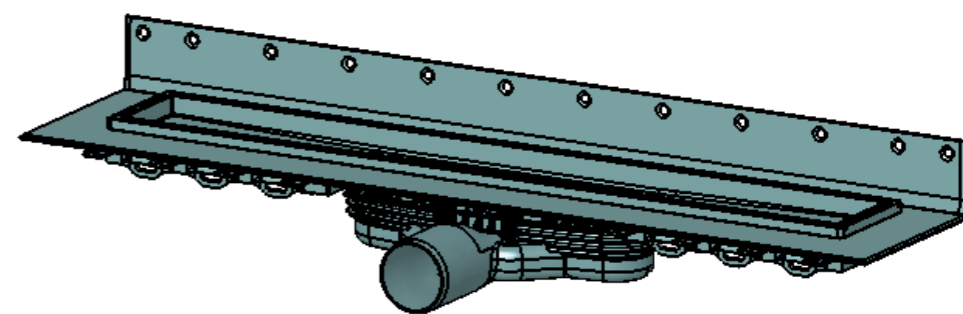

Denna handling får ej utan vårt medgivande kopieras. Den får ej heller delgivas annan eller ejlest obehörigen användas. Överträdelse härav beivras med stöd av gällande lag. Purus AB

Annotation Måttskiss		A3		This drawing replace		Replaced by		Date	
PURUS		Scale 1:3	Page 1(1)	General tolerance. ISO 2768-1 medel		Weight (gram)		Volume (cm3)	
Purus AB Södra Dragongatan 15 SE-271 39 YSTAD, SWEDEN Ph. +46 104144900 Fax +46 104144996 www.purus.se		Material Sammanställning		Surface treatment -		Designer SwS		Created date 2016-02-26	
Name Afløbsrende 50/600 mm		Article no 155804-312		Edition 2					