

# I-GUIDE

## SAFETY PANEL M 1,7 M

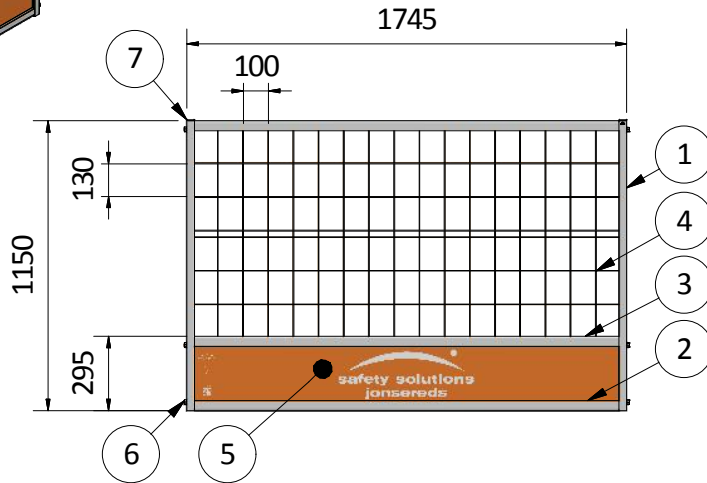
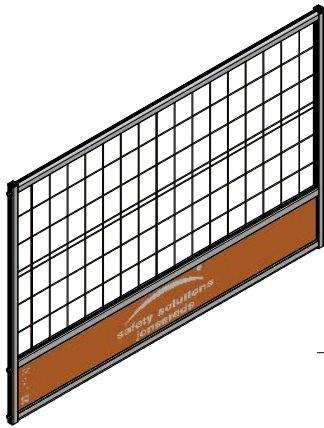

Art nr 9-720-01-026

8,7 kg

EN 13374 A-B-C

Max c/c Class A/B: 1,6 m

Max c/c Class C: 1,2 m

[mm]

ITEM	QTY	ART. NO
1	2	9-720-01-002
2	2	9-720-01-027
3	1	9-720-01-028
4	1	9-720-01-030
5	1	9-720-01-029
6	6	6-50-5-00001
7	2	6-89-000002

### EN 13374 - A/B

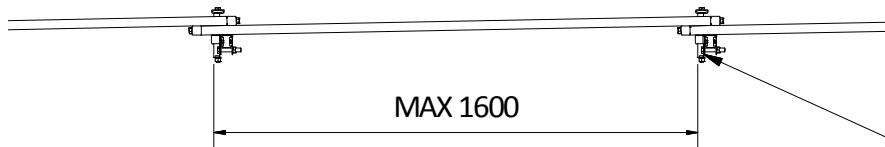

GuardLite Post & Holder  
9-720-02-021

### EN 13374 - C

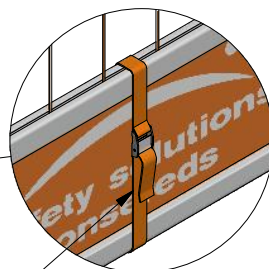
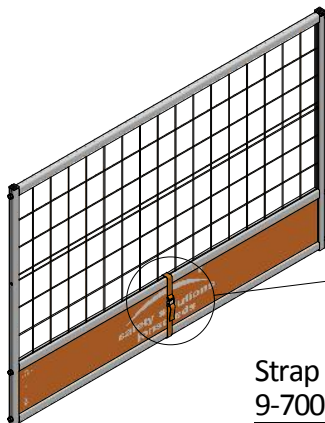
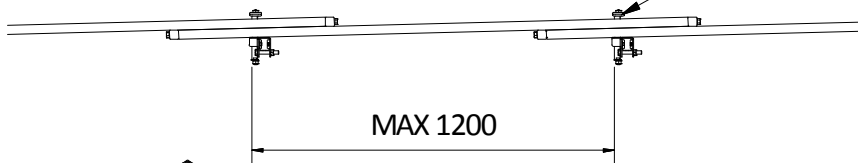

Strap SSJ W25 L800  
9-700-00-005

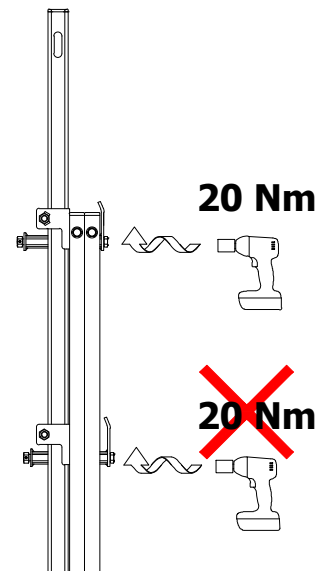

20 Nm

20 Nm