

MULE™ 4010 4×4
MULE™ 4000

Utility Vehicle

OWNER'S MANUAL

 Read this manual carefully. It contains safety information.

Kawasaki

Quick Reference Guide

This Quick Reference Guide will assist you in finding the information you're looking for.

GENERAL INFORMATION

HOW TO OPERATE

SAFE OPERATION

MAINTENANCE AND ADJUSTMENT

STORAGE

TROUBLESHOOTING GUIDE

ENVIRONMENTAL PROTECTION

A Table of Contents is included after the Foreword.

Whenever you see the symbols shown below, heed their instructions! Always follow safe operating and maintenance practices.

 DANGER

DANGER indicates a hazardous situation which, if not avoided, will result in death or serious injury.

 WARNING

WARNING indicates a hazardous situation which, if not avoided, could result in death or serious injury.

NOTICE

NOTICE is used to address practices not related to personal injury.

NOTE

○ *NOTE* indicates information that may help or guide you in the operation or service of the vehicle.

 WARNING

Engine exhaust, some of its constituents, and certain vehicle components contain or emit chemicals known to the State of California to cause cancer and birth defects or other reproductive harm.

EMISSION CONTROL INFORMATION

To protect the environment in which we all live, Kawasaki has incorporated crankcase emission (1), exhaust emission (2) and evaporative emission (3) control systems in compliance with applicable regulations of the United States Environmental Protection Agency and California Air Resources Board.

1. Crankcase Emission Control System

A sealed-type crankcase emission control system is used to eliminate blow-by gases. The blow-by gases are led to the breather chamber through the crankcase. Then, it is led to the intake manifold.

Oil is separated from the gases while passing through the inside of the breather chamber from the crankcase, and then returned back to the bottom of the crankcase.

2. Exhaust Emission Control System

The exhaust emission control system applied to this engine family is engine modifications that consist of a fuel injection system and ignition system having optimum ignition timing characteristics.

The fuel injection system has been calibrated to provide lean air/fuel mixture characteristics and optimum fuel economy with a suitable air cleaner and exhaust system.

A maintenance free ignition system provides the most favorable ignition timing and helps maintain a thorough combustion process within the engine which contributes to a reduction of exhaust pollutants entering the atmosphere.

3. Evaporative Emission Control System

The evaporative emission control system for this vehicle consists of low permeation fuel hoses and fuel tank.

Also, vapors caused by fuel evaporation in the fuel system are not vented into the atmosphere. Instead, fuel vapors are routed into the running engine to be burned, or stored in a canister when the engine is stopped.

Maintenance and Warranty

Proper maintenance is necessary to ensure that your vehicle will continue to have low emission levels. This Owner's Manual contains those maintenance recommendations for your vehicle. Those items identified by the Periodic Maintenance Chart are necessary to ensure compliance with the applicable standards.

As the owner of this vehicle, you have the responsibility to make sure that the recommended maintenance is carried out according to the instructions in this Owner's Manual at your own expense.

You should keep a maintenance record for your vehicle. To assist you in keeping this record, we have provided space at the end of this manual where an authorized Kawasaki dealer, or someone equally competent, can record the maintenance. You should also retain copies of maintenance work orders, bills, etc., as verification of this maintenance.

If there is a problem with the emission control system within the warranty period, you will need to take it and any maintenance records to an authorized Kawasaki dealer for inspection and diagnosis. Kawasaki will work closely with your dealer to resolve any warranty issues. If you are unable to resolve any problem after consulting with the dealership management and need further assistance, contact Kawasaki Motors Corp., U.S.A. at the following address:

Consumer Services
Kawasaki Motors Corp., U.S.A.
P.O. Box 25252
Santa Ana, CA 92799-5252
(866) 802-9381
consumer.services@kawasaki-usa.com

Tampering with Emission Control System Prohibited

Federal law prohibits the following acts or the causing thereof: (1) the removal or rendering inoperative by any person other than for purposes of maintenance, repair, or replacement, of any device or element of design incorporated into any new vehicle for the purposes of emission control prior to its sale or delivery to the ultimate purchaser or while it is in use, or (2) the use of the vehicle after such device or element of design has been removed or rendered inoperative by any person.

Among those acts presumed to constitute tampering are the acts listed below:

Do not tamper with the original emission related parts:

- Fuel injection system and internal parts
- Spark plugs
- Magneto or electronic battery ignition system
- Fuel filter
- Air cleaner element

PLEASE DO NOT TAMPER WITH NOISE CONTROL SYSTEM

To minimize the noise emissions from this product, Kawasaki has equipped it with effective intake and exhaust silencing systems. They are designed to give optimum performance while maintaining a low noise level. Please do not remove these systems, or alter them in any way which results in an increase in noise level.

FOREWORD

Congratulations on your purchase of a new Kawasaki Mule. It is the result of Kawasaki's engineering expertise and a tradition of manufacturing high-quality consumer products.

Please read this Owner's Manual carefully before starting your new Mule so that you will be thoroughly familiar with the proper operation of your vehicle's controls, its features, capabilities, and limitations.

To ensure a long, trouble-free life for your Mule, give it the proper care and maintenance described in this manual.

For those who would like more detailed information on their Mule, a Service Manual is available for purchase from any authorized Kawasaki Mule dealer. The Service Manual contains detailed disassembly and maintenance information. Those who plan to do their own work should, of course, be competent mechanics and possess the special tools described in the Service Manual.

Keep this Owner's Manual aboard your Mule at all times so that you can refer to it whenever you need information.

This manual should be considered a permanent part of the Mule and should remain with the Mule when it is sold.

All rights reserved. No part of this publication may be reproduced without our prior written permission.

This publication includes the latest information available at the time of printing. However, there may be minor differences between the actual product and illustrations and text in this manual.

All products are subject to change without prior notice or obligation.

KAWASAKI HEAVY INDUSTRIES, LTD.
Motorcycle & Engine Company

TABLE OF CONTENTS

BASIC SAFE DRIVING	9	Seat	50
SPECIFICATIONS	11	Seat Belts	51
SERIAL NUMBER LOCATIONS	15	Throttle Pedal	53
LOCATION OF PARTS	16	Trailer Hitch Bracket	53
LOCATION OF LABELS	19	Winch Installation	54
LOADING INFORMATION	29	HOW TO OPERATE	56
GENERAL INFORMATION	31	Daily Checks	56
Lighting/Electrical Accessory Connector	31	Starting the Engine	58
Light Switch	31	Jump Starting	59
Coolant Temperature Warning Light	32	Moving Off	61
Oil Pressure Warning Light	33	Braking	61
Fuel Injection Warning Light	34	Stopping the Engine	62
Parking Brake Warning Light	34	Parking the Mule	62
Power Steering Warning Light (KAF620M) ...	35	Hi-Lo Shifting (KAF620M)	64
Steering Wheel (KAF620M)	35	Reversing Gears	65
Brake Pedal	36	2WD-4WD Shifting (KAF620M)	65
Cargo Bed	36	Shifting the Differential	66
Tailgate	36	SAFE OPERATION	68
Cargo Bed	37	Unfamiliar Terrain	68
Fuel Tank	38	Driving in Reverse	69
Glove Compartment	41	Driving in "4WD" (KAF620M)	69
Front Cargo Compartment	42	Turning the Vehicle	70
Horn Button	43	Hills	70
Ignition Switch	44	Climbing Hills	71
Keys	45	Descending Hills	72
Fuel Gauge/Hour Meter	46	Traversing Hillsides	73
Shift Levers	47	Sliding and Skidding	73
Gear Shift Lever	47	Driving through Water	74
2WD-4WD Shift Lever (KAF620M)	48	MAINTENANCE AND ADJUSTMENT	75
Differential Shift Lever	49	Periodic Maintenance Chart	76
Parking Brake Lever	49	Engine Oil	79

Front Final Gear Case Oil (KAF620M)	83
Transmission Case Oil	86
Cooling System	89
Spark Plugs	92
Valve Clearance	93
Engine Air Cleaner	94
Evaporative Emission Control System	96
Spark Arrester	97
Throttle Pedal	98
Idle Adjustment.....	101
Fuel Pump Filter	102
Fuel Tank Vent.....	102
Belt Drive Torque Converter	103
Belt Drive Torque Converter Air Cleaner	104
Brakes	106
Brake Pedal.....	106
Brake Light Switch.....	108
Parking Brake Lever.....	109
Steering Wheel.....	111
Power Steering System (KAF620M)	112
Wheels	112
Rims	112
Wheel Nuts.....	112
Tires	112
Joint Boots.....	114
Seat Belts	115
Headlight Beam	116
Battery	117
Fuse	121
Power Steering System (KAF620M)	121
Breaker	122
General Lubrication	123
Cleaning	124
Bolt and Nut Tightening.....	125

STORAGE	126
TROUBLESHOOTING GUIDE	128
YOUR WARRANTY/OWNER SATISFACTION	129
ENVIRONMENTAL PROTECTION	133
MAINTENANCE RECORD	134

BASIC SAFE DRIVING

Knowing and following these rules for safe operation will increase your satisfaction with your new Kawasaki vehicle.

Perform the Daily Checks

Refer to the Daily Checks section for a list of items to check each day before use. Habitual performance of these checks will help to insure safer, more reliable usage. Be sure that any irregularities found during these checks are corrected before operating the vehicle.

Drive Carefully and with Good Judgement

We want you to be satisfied with your new Kawasaki vehicle, so drive carefully, safely, and exercise good judgement. Practice basic maneuvers so you can drive confidently and safely.

Read the Owner's Manual

Read and understand this Owner's Manual. This is especially important for inexperienced drivers. Refer to this Owner's Manual if you have any questions.

Off-Highway Use Only

This vehicle is not an all-terrain vehicle; it is designed and equipped to be a multiuse utility vehicle for off-highway use only. Use of this vehicle on public roads and paved surfaces is hazardous. Do not operate this vehicle on public roads or paved surfaces.

Occupant Capacity

Make sure operators are 16 years or older with a valid driver's license.

Each occupant must be able to sit with back against seat, feet flat on floor, and hands on steering wheel, handgrip or handhold.

The operator should be tall enough to wear the seat belt properly and reach all controls.

Passenger(s) should also be tall enough for the seat belt to fit properly and to be able to brace themselves, as necessary, by placing both feet firmly on the floor while gripping the handhold. Stay completely inside the vehicle.

Never Drink and Drive

Alcohol and drugs impair your judgement and slow your reactions. Even drugs prescribed by a physician can be dangerous. Check with your doctor.

10 BASIC SAFE DRIVING

Use Proper Riding Gear

Proper protective gear can reduce the severity of injury in the event of an accident.

Choose a helmet most appropriate for your use of this utility vehicle. A helmet can reduce the risk of head injuries. Wear appropriate eye protection and protective clothing.

Wearing Seat Belts

Both the operator and passenger(s) should always wear their seat belts properly. Seat belts cannot completely protect you in every accident, but in many cases a seat belt can reduce the risk of serious injury. Also, to avoid injury, do not put any part of your body outside of the vehicle for any reason.

Before Starting the Engine

Three “musts” before starting the engine are:

1. Apply the parking brake,
2. Put the gear shift lever in the “N” (neutral) position,
3. Check the throttle pedal for proper operation. It should return to its rest position when released.

Use the Parking Brake

Always apply the parking brake before getting out of your vehicle.

Obey Local Laws

Know and obey all laws and regulations governing the use of off-highway vehicles in your area. Respect private property. Always try to preserve nature and the environment.

Refueling

Before refueling the vehicle, shut the engine off and make sure the area is well ventilated and free of any source of flame or sparks. Gasoline is very flammable.

Tire Air Pressure

Tire inflation and type can affect the vehicle’s handling characteristics. Check the tire pressure frequently. Use only the recommended tires for replacement.

SPECIFICATIONS

PERFORMANCE

Maximum Torque	47.0 N·m (4.8 kgf·m, 34.7 ft·lb) @2 500 r/min (rpm)
Minimum Turning Radius	
Differential Mode	3.4 m (11.2 ft)
Seating Capacity	2 persons

DIMENSIONS

Overall Length	2 965 mm (116.73 in.)
Overall Width	1 575 mm (62.01 in.)
Overall Height	1 925 mm (75.79 in.)
Wheelbase	1 870 mm (73.62 in.)
Tread:	Front 1 160 mm (45.67 in.)
	Rear 1 180 mm (46.46 in.)
Ground Clearance	175 mm (6.89 in.)
	(P) 190 mm (7.48 in.)
Curb Mass	649 kg (1 431 lb)
	(P) 606 kg (1 336 lb)
Cargo Bed (L × W × H)	1 175 × 1 310 × 290 mm
	(46.26 × 51.57 × 11.42 in.)

ENGINE

Type	OHV, 2-cylinder, 4-stroke, liquid-cooled
Displacement	617 cm ³ (37.6 cu in.)
Bore × Stroke	76 × 68 mm (2.99 × 2.68 in.)
Compression Ratio	10.3 : 1

12 SPECIFICATIONS

Starting System		Electric starter
Cylinder Numbering Method		Front to rear, 1-2
Firing Order		1-2
Carburetion System		FI (Fuel Injection)
Ignition System		Magneto and transistor
Ignition Timing		5° BTDC @750 r/min (rpm) ~ 22° BTDC @4 000 r/min (rpm)
Spark Plug		NGK BPR2ES
Lubrication System		Forced lubrication (wet sump)
Engine Oil:	Type	API SG, SH, SJ, SL or SM with JASO MA, MA1 or MA2
	Viscosity	SAE 10W-40
	Capacity	1.8 L (1.9 US qt)
Coolant Capacity		4.3 L (4.5 US qt)

DRIVE TRAIN

Driving Type		4WD gear, (P) 2WD gear
Transmission Type		2-speed & reverse, automatic (P) 1-speed & reverse, automatic
Primary Reduction Ratio		3.9 ~ 0.85 (Belt drive torque converter)
Final Reduction Ratio:	Front	(M) 5.200
	Rear	5.429
Overall Drive Ratio:	Forward	8.404 (High) (M) 17.303 (Low)
	Reverse	19.475, (P) 9.459

Transmission Gear Ratio:	Forward	1.821 (High) (M) 3.750 (Low)
	Reverse	4.220, (P) 2.050
Front Final Gear Case Oil		(M) API GL-5 SAE140 or API GL-6 SAE90 Hypoid gear oil for Limited Slip Differentials
Front Final Gear Case Oil Capacity		(M) 0.4 L (0.4 US qt)
Transmission Case Oil		API GL-5 Hypoid gear oil, SAE 90 [above 5°C (41°F)] SAE 80 [below 5°C (41°F)]
Transmission Case Oil Capacity		2.5 L (2.6 US qt), (P) 2.2 L (2.3 US qt)

FRAME

Type		Steel tube, ladder type
Steering		Assisted with Electric Power Steering (EPS) System (P) Manual (rack and pinion)
Caster		7.5°
Trail		35 mm (1.4 in.)
Tire Size:	Front & Rear	23 × 11.00-10 Tubeless
Rim Size:	Front & Rear	10 × 8.5 AT
Fuel Tank Capacity		24 L (6.3 US gal)

ELECTRICAL EQUIPMENT

Battery		12 V 14 Ah
Headlight		12 V 35 W × 2
Tail/Brake Light		12 V 5/21 W × 2

14 SPECIFICATIONS

LOAD CAPACITY

Maximum Vehicle Load (Including occupants
and cargo) 603 kg (1 330 lb)

Maximum Cargo Bed Load 363 kg (800 lb)

(M): KAF620M

(P): KAF620P

MODEL INFORMATION

MULE4010 4 × 4.....KAF620M

MULE4000.....KAF620P

Specifications are subject to change without notice.

SERIAL NUMBER LOCATIONS

The engine and frame serial numbers are used to register the vehicle. They are the only means of identifying your particular machine from others of the same model type. These serial numbers may be needed by your dealer when ordering parts. In the event of theft, the investigating authorities will require both numbers as well as the model type and any peculiar features of your machine that can help them identify it.

Frame No.

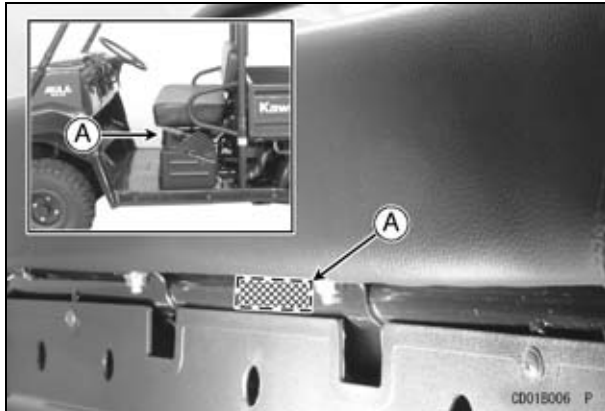

A. Frame Number

Engine No.

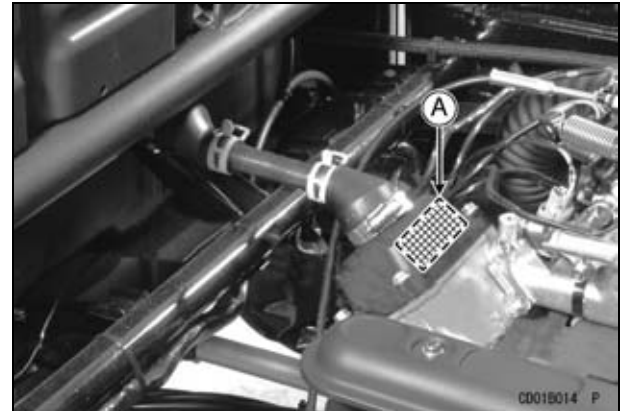

A. Engine Number

LOCATION OF PARTS

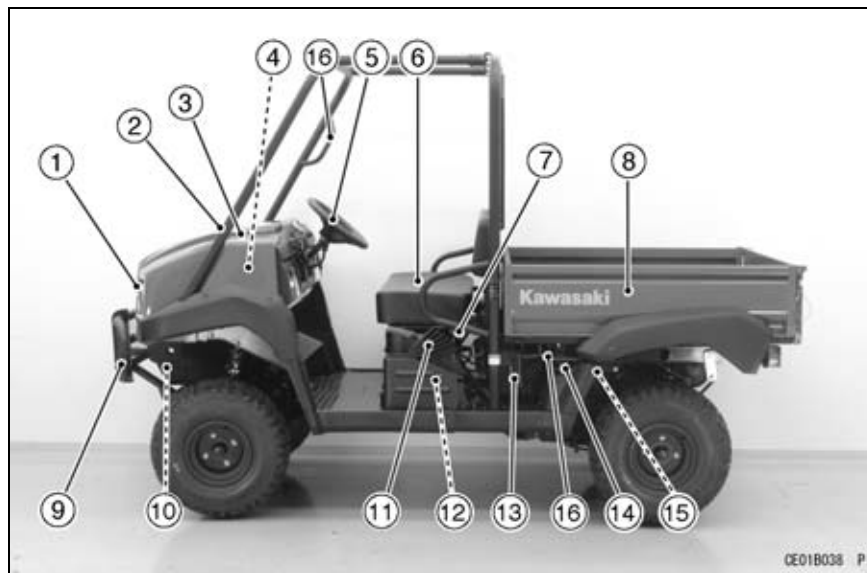

- 1. Headlights
- 2. ROPS (Roll Over Protective Structure)
- 3. Front Cargo Hood
- 4. Front Cargo Compartment
- 5. Steering Wheel
- 6. Seat

- 7. Seat Belts
- 8. Cargo Bed
- 9. Front Bumper
- 10. Radiator
- 11. Parking Brake
- 12. Battery
- 13. Latch

- 14. Air Cleaner (Belt Drive Torque Converter)
- 15. Belt Drive Torque Converter
- 16. Handgrip

OE01B038 P



- 17. Screen
- 18. Latch Handle
- 19. Tail Gate
- 20. Dashboard

- 21. Coolant Reserve Tank
- 22. Tail/Brake Lights
- 23. Trailer Hitch Bracket
- 24. Muffler (Spark Arrester)

- 25. Fuel Tank
- 26. Fuel Tank Cap
- 27. Air Cleaner

18 LOCATION OF PARTS

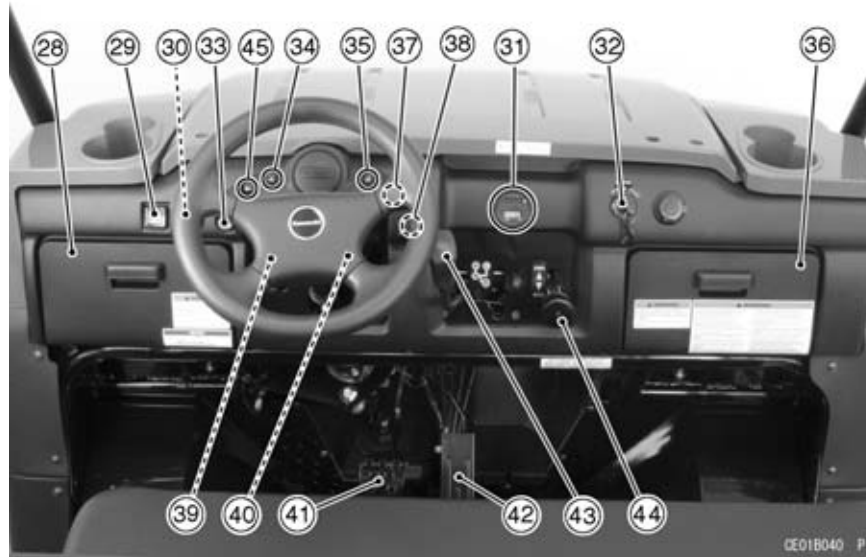

- 28. Left Glove Compartment
- 29. Light Switch
- 30. Horn Button
- 31. Fuel Gauge/Hour Meter
- 32. Ignition Switch
- 33. Latch Release Knob
- 34. Coolant Temperature Warning Light

- 35. Parking Brake Warning Light
- 36. Right Glove Compartment
- 37. FI Warning Light
- 38. Power Steering Warning Light (KAF620M)
- 39. Differential Shift Lever
- 40. Brake Fluid Reserve Tank

- 41. Brake Pedal
- 42. Throttle Pedal
- 43. Gear Shift Lever
- 44. 2WD-4WD Shift Lever (KAF620M)
- 45. Oil Pressure Warning Light

LOCATION OF LABELS

All warning labels which are on your vehicle are repeated here. Read labels on your vehicle and understand them thoroughly. They contain information which is important for your safety and the safety of anyone else who may operate your vehicle. Therefore, it is very important that all warning labels be on your vehicle in the locations shown. If any label is missing, damaged, or worn, get a replacement from your Kawasaki dealer and install it in the correct position.

NOTE

- *The sample warning labels in this section have part numbers to help you and your dealer obtain the correct replacement.*
- *Refer to the actual vehicle label for model specific data grayed out in the illustration.*

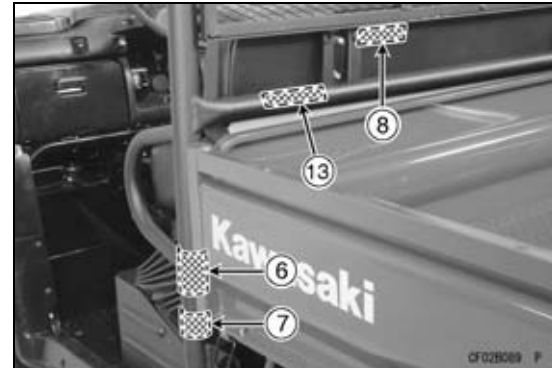
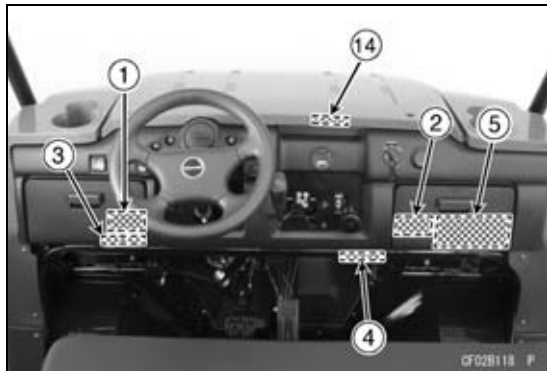

1. Warning (Off-Highway Utility Vehicle)
2. Warning (Front Cargo Hood)
3. Notice (Shifting)
4. Specification
5. Warning (General)
6. Important Information (Tires/Max. Load)
7. Warning (Cargo Bed)
8. Warning (Cargo Bed)
13. Specification (Under the seat)
14. Information (Front Hood)

20 LOCATION OF LABELS

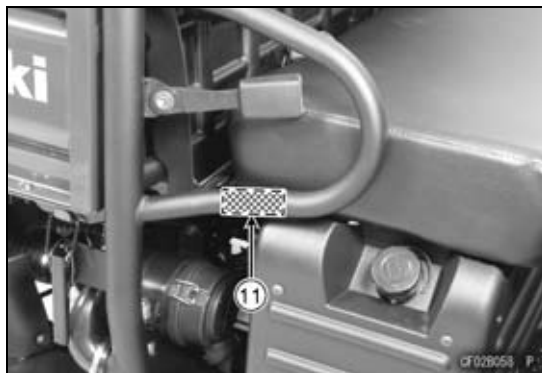
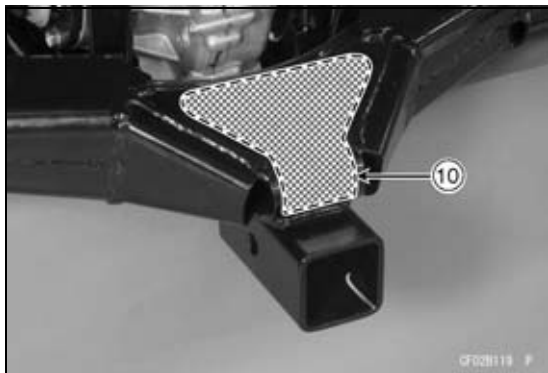
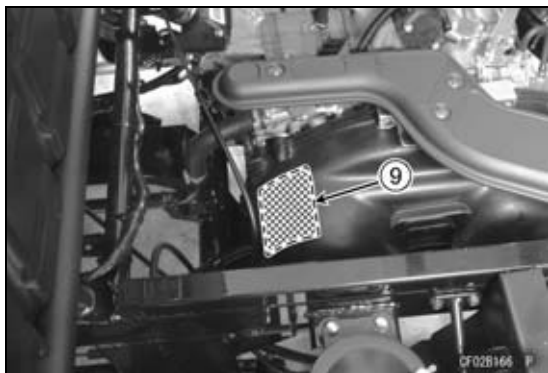

- 9. Warning (Hot Surfaces)
- 10. Warning (Towing Bracket/Trailer)
- 11. Warning (Refueling)

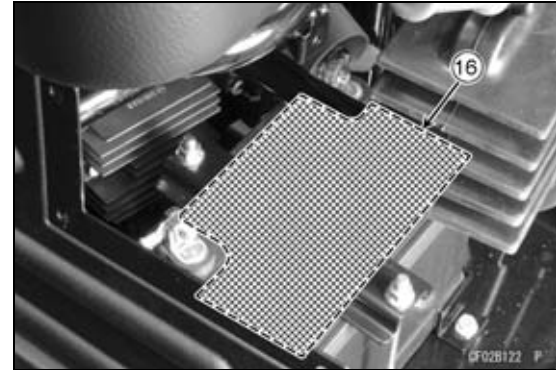
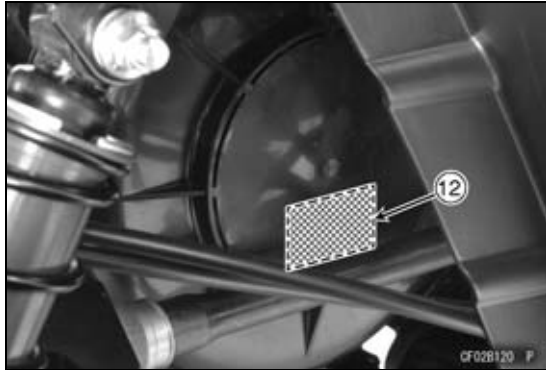

- 12. Important Engine Information**
- 15. Important Emission Information**
- 16. Battery Danger/Poison (On the backside)**

22 LOCATION OF LABELS

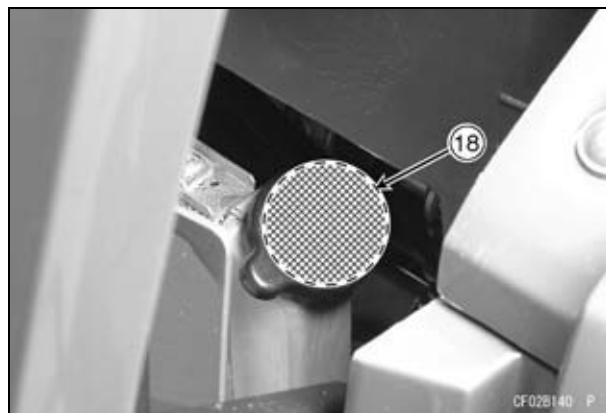

- 17. Brake Fluid
- 18. Radiator Cap Danger

(1)

 WARNING
<p>This is an off-highway utility vehicle which will handle and maneuver differently from an ordinary passenger car.</p> <p>Sharp, high speed turns or abrupt maneuvers can cause this vehicle to roll over or go out of control.</p> <p>Read and understand operating instructions in the Owner's Manual and follow all warning instructions. The handling characteristics of this vehicle change depending upon cargo load and driving modes.</p>

56070-0050
CF03052BM2 C

(2)

 WARNING
<p>An open front cargo hood can distract or impair visibility of the operator, causing loss of vehicle control and potential serious injury or death.</p> <p>Latch the hood securely before operating the vehicle.</p>

56070-0053

CF03051BM2 C









(3)

NOTICE
<p>Shifting incorrectly can damage transmission. Shift only when:</p> <ul style="list-style-type: none"> ○ Engine is at slow idle. ○ Vehicle is completely stopped.

56071-0128

CF03980B S

(4)

MFD. BY KAWASAKI MOTORS MFG. CORP., U.S.A.	
MODEL: 	MODEL YEAR: 
MAX. POWER: 	 [kW/rpm]
CURB MASS: 	 kg
G.V.W.R.: 	 kg

CF03045CN6 C

24 LOCATION OF LABELS

(5)

 WARNING	
<p>The Owner's Manual and warning labels contain important information on safe operation of this vehicle. You must read and fully understand instructions in Owner's Manual and warning labels before operating this vehicle. Keep Owner's Manual with this vehicle at all time.</p>	<p>Protective head gear reduces the risk of head injuries. A helmet is recommended when this vehicle is being used for recreational purposes or any aggressive driving. Please refer to the Owner's Manual for information on proper riding gear.</p>
<p>Improper use of this vehicle can be hazardous. Never operate at speeds too fast for your skills or conditions. Handling characteristics of this vehicle change depending upon cargo load and driving modes. Use proper driving techniques on hills, in rough terrain, and in water.</p>	<p>Seat belts reduce injuries. Operator and passenger must always fasten seat belts during vehicle operation.</p>
<p>Use of this vehicle on public roads and paved surfaces is hazardous. This vehicle is designed and equipped for off-highway use only. Do not operate this vehicle on public roads or paved surfaces.</p>	<p>Carrying passengers outside the passenger compartment can be hazardous. This vehicle is designed to carry the operator and only one passenger in the seat provided. Never carry a passenger in the cargo bed.</p>
<p>Children may not have skills and judgment to safely operate this vehicle. All operators of this vehicle should possess a valid driver's license.</p>	<p>Failure to apply parking brake may result in vehicle moving inadvertently with the potential for causing damage and injury. Always apply parking brake before exiting vehicle.</p>
	<p>Alcohol and drugs impair reaction time and judgment. Never operate this vehicle under influence of alcohol or drugs.</p>

56071-0101

(6)

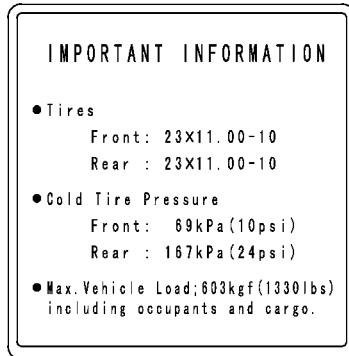

56053-7534

CF03231BM2 C

(8)

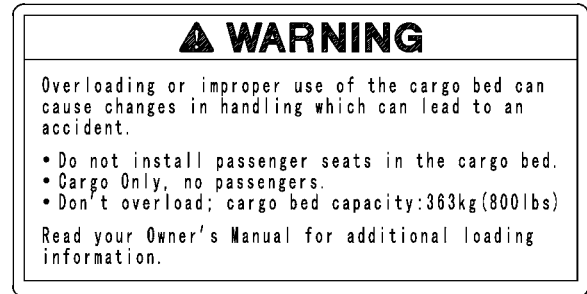

56071-0136

CF03331BM2 C

(7)



56070-7515

CF03124BM2 C

(9)



56070-0051

CF03347BM2 C

26 LOCATION OF LABELS

(10)

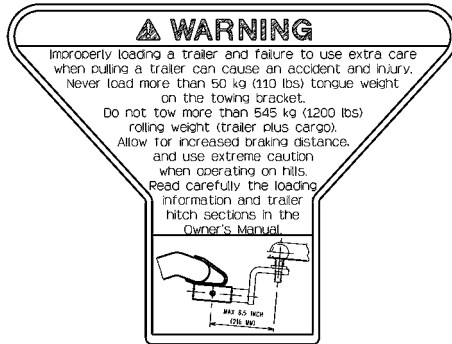

56071-0332

CF03894B S

(12)

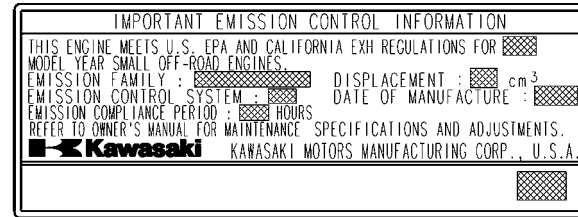

CF03034C S

(11)

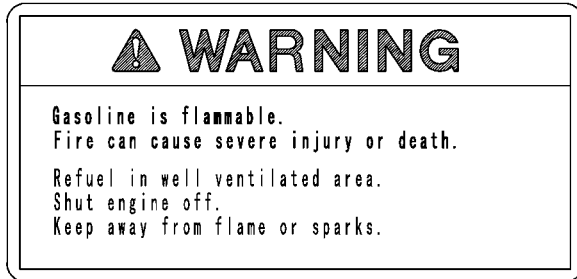

56071-7501

CF03150B2 C

(13)

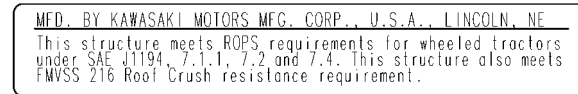

CF03959B S

(14)

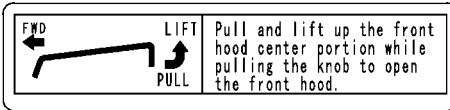



56030-0267

CF03377BN6 C

(15)

EMISSION CONTROL INFORMATION

THIS EQUIPMENT MEETS U.S. EPA EVP STANDARDS AND  CALIFORNIA EVP EMISSION REGULATIONS FOR SMALL OFF-ROAD ENGINES.

EPA: EQUIPMENT FAMILY --- 

CARB: EVP FAMILY I.D. --- 

DATE OF MFG. ----- 

Kawasaki
KAWASAKI MOTORS MANUFACTURING CORP., U.S.A.

CF03856BM2 C

(16)

MAINTENANCE FREE • SANS ENTRETIEN • LIBRE DE MANTENIMIENTO

⚠ DANGER/POISON !PELIGRO/VENENO!

<p> SHIELD EYES.</p> <p>EXPLOSIVE GASES CAN CAUSE BLINDNESS OR INJURY.</p> <p>PROTEJEZ LOS OJOS. LOS GASES EXPLOSIVOS PUEDEN CAUSAR DAÑOS O CEGUEZA.</p> <p>PROTEJA LOS OJOS. LOS GASES EXPLOSIVOS PUEDEN CAUSAR DAÑOS O CEGUEZA.</p>	<p> NO SPARKS</p> <p>+ FLAMES</p> <p>+ SMOKING</p> <p>EVITER LES ETINCELLES</p> <p>+ LES FLAMMES</p> <p>+ FUMIGES</p> <p>NO CHISPAS</p> <p>+ FLAMAS</p> <p>+ CIGARRILLOS</p>	<p> SULFURIC ACID</p> <p>CAN CAUSE BLINDNESS OR SEVERE BURNS.</p> <p>L'ACIDE SULFURIQUE PEUT CAUSER LA CECITE OU DES OUI BRULURES GRAVES.</p> <p>ACIDO SULFURICO PUEDE CAUSAR CEGUEZA O QUEMADURAS FUERTES.</p>	<p> FLUSH EYES IMMEDIATELY WITH WATER. GET MEDICAL HELP FAST.</p> <p>RINCEJE LOS OJOS A L'EAU IMMEDIATEMENT CONSULTATEZ UN MEDICIN RAPIDEMENT.</p> <p>ENLARGUE LOS OJOS INMEDIATAMENTE CON AGUA. ACUDA RAPIDO CON EL MEDICO.</p>
---	--	--	--

KEEP OUT OF THE REACH OF CHILDREN. DO NOT TIP. DO NOT OPEN BATTERY!
TENIR HORS DE LA PORTEE DES ENFANTS. NE PAS RENVERSEZ. NE PAS OUVRIE LA BATTERIE!
ALLEJSE DEL ALCANCE DE LOS NIÑOS. NO VOLTEAR. ¡NO ABRIR LA BATERIA!

CALIFORNIA PROPOSITION 65 WARNING: Batteries, battery posts, terminals and related accessories contain lead and lead compounds, and other chemicals known to the State of California to cause cancer and birth defects or other reproductive harm. WASH HANDS AFTER HANDLING.

Dist. by: par:par
KMC
Irvine, CA 92618

MADE IN U.S.A.
FABRIQUE AUX E.U.A.
HECHO EN U.S.A.

Pb

CF03888B S

(17)



CF03962B S

28 LOCATION OF LABELS

(18)



BD03299C S

LOADING INFORMATION

WARNING

Incorrect loading, improper installation or use of accessories, or modification of your vehicle may result in an unsafe operating condition. Before you operate it, make sure that the vehicle is not overloaded and that you have followed these instructions.

With the exception of genuine Kawasaki Parts and Accessories, Kawasaki has no control over the design or application of accessories. In some cases, improper installation or use of accessories, or vehicle modifications, will void the utility vehicle warranty. In selecting and using accessories, and in loading the vehicle, you are personally responsible for your own safety and the safety of other person involved.

NOTE

○ *Kawasaki Parts and Accessories have been specially designed for use on Kawasaki utility vehicles. We strongly recommend that all parts and accessories you add to your vehicle be genuine Kawasaki components.*

Because any vehicle is sensitive to increases in weight and changes in weight distribution, you must take care in carrying cargo. The following general guidelines have been prepared to help you make your determinations.

- Reduce speed when carrying cargo. Braking distance is increased. Use extreme caution when climbing and descending hills, and traversing slopes. Carrying cargo and pulling a trailer can make the vehicle difficult to steer and may affect vehicle handling in an unpredictable manner.
- Do not operate this vehicle faster than 16 km/h (10 mph) when pulling a trailer.
- All cargo should be carried as low as possible to reduce the effect on the vehicle's center of gravity. Cargo weight should be equally distributed from side to side. This helps maintain stability by centralizing weight. Avoid carrying cargo that extends beyond the rear of the vehicle. Do not carry cargo on top of the ROPS.
- Do not carry more than 363 kg (800 lb) in the cargo bed.
- Cargo should be securely anchored. Make sure the cargo will not move around while the vehicle is moving. Recheck cargo security as often as possible (while the vehicle is stopped) and adjust as necessary.

NOTICE

The front body work and fenders are not designed to carry cargo or to support your weight. They may break.

30 LOADING INFORMATION

- Always subtract trailer tongue weight from the Maximum Load capacity. Refer to the “Trailer Hitch Bracket” section in the “General Information” chapter.

Maximum Vehicle Load

Weight of operator, passenger, and cargo must not exceed 603 kg (1 330 lb).

- This vehicle is not designed to carry passengers in the cargo bed. Installing additional passenger seating or carrying passengers in the cargo bed can cause changes in vehicle handling.

WARNING

Passengers riding in the cargo bed can be tossed about or even thrown out causing serious injury or death. Do not install seating or carry passengers in the cargo bed.

GENERAL INFORMATION

Lighting/Electrical Accessory Connector

The lighting/electrical accessory 12 volt connectors are located on the dashboard.

An auxiliary light or an accessory may be connected to this connector.



A. Connectors

NOTICE

Do not connect a light or load of more than 120 watts to these connectors, or the battery may become discharged very rapidly.

Light Switch

Turn on the headlights and taillights by pushing the light switch in, with the ignition switch key in the "ON" position.

The lights go off when the switch is pushed again.

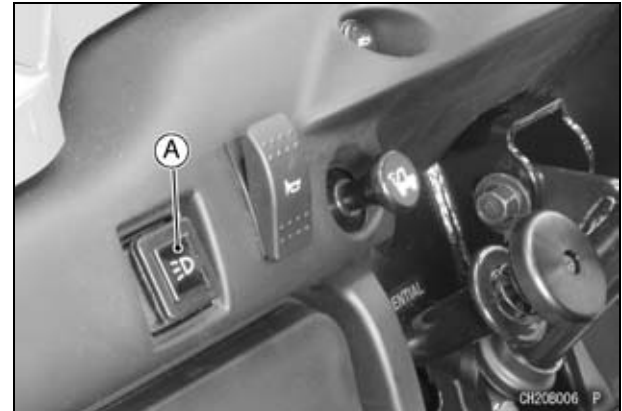

A. Light Switch

32 GENERAL INFORMATION

Coolant Temperature Warning Light

The coolant temperature warning light (TEMP) comes on whenever the coolant temperature rises too high while the vehicle is in operation or when the ignition switch key is turned to ON. If it stays on, stop the engine and check the coolant level in the reserve tank after the engine cools down.

Refer to the “Cooling System” section in the “Maintenance and Adjustment” chapter.

Also check the breaker of the radiator fan and, if it has functioned, reset the breaker. Be sure to check that the radiator fan is free from mud and other obstacles. See Breaker section of MAINTENANCE AND ADJUSTMENT chapter.



A. Coolant Temperature Warning Light

NOTICE

Do not let the engine continue running with a warning light on. Prolonged engine operation can result in engine damage from overheating.

Oil Pressure Warning Light

The oil pressure warning light goes on whenever the oil pressure is dangerously low or the ignition switch key is in the ON position with the engine not running, and goes off when the engine oil pressure is high enough.

NOTICE

If the engine oil gets extremely low or if the oil pump does not function properly, or oil passages are clogged, or otherwise do not function properly, the oil pressure warning light will light. If this light stays on when the engine speed is running slightly above the idle speed, stop the engine immediately and find the cause.



A. Oil Pressure Warning Light

34 GENERAL INFORMATION

Fuel Injection Warning Light

The fuel injection (DFI) warning light goes on when the ignition switch key is turned to “ON” and goes off soon after ensuring that its circuit functions properly. The warning light also goes on whenever the troubles occur in digital fuel injection system (DFI). If the warning light comes on, have the DFI system checked by an authorized Kawasaki dealer.



A. Fuel Injection Warning Light

Parking Brake Warning Light

The parking brake warning light goes on when the parking brake is applied with the ignition switch in the “ON” position.

NOTE

- *This light shows only that the parking brake is on. It does not show the degree of parking brake application.*



A. Parking Brake Warning Light

Power Steering Warning Light (KAF620M)

The power steering warning light will momentarily illuminate when the engine starts, then goes off in one second if the system is in order. If the warning light illuminates any other time, it indicates the ECU or actuator has malfunctioned, or the wiring harness has become disconnected. Stop driving immediately and see an authorized Kawasaki dealer to have the system checked.



A. Power Steering Warning Light

NOTE

- *If the warning light does not go on when the engine starts, there may be a problem with the light itself. See a dealer for inspection.*

Steering Wheel (KAF620M)

This vehicle is equipped with an electric power steering system. The system does not require regular maintenance by users. Do not tamper with the electronic control unit (ECU) or loosen the fittings of steering actuator, or the neutral position setting of the steering will be adversely affected and will cause serious driving problems. If such components need service, see an authorized Kawasaki dealer.

If the steering becomes more difficult than usual or you experience other steering problems, refer to the “Steering Wheel” section in the “MAINTENANCE AND ADJUSTMENT” chapter. The steering wheel position can be adjusted to suit the operator (see “Steering Wheel” section).

NOTE

- *The power steering system functions only when engine is running.*
- *If you install wireless equipment on board, contact an authorized dealer. Installing such equipment improperly may affect the ECU.*

36 GENERAL INFORMATION

Brake Pedal

The brake pedal is the left pedal on the foot board. Depress the pedal to slow or stop the vehicle.



A. Brake Pedal

Cargo Bed

Tailgate

The tailgate can be lowered. Before lowering the tailgate, park on a firm level surface and set the parking brake. Raise the latch handles at each end of the tailgate and slide both latches toward the center of the vehicle. The tailgate can now be lowered. The gate is held level to the cargo bed floor with cables.

Close the tailgate by sliding both latches toward the center of the vehicle. Push the handles down to make sure the latches stay securely closed. Do not drive the vehicle with the tailgate lowered.

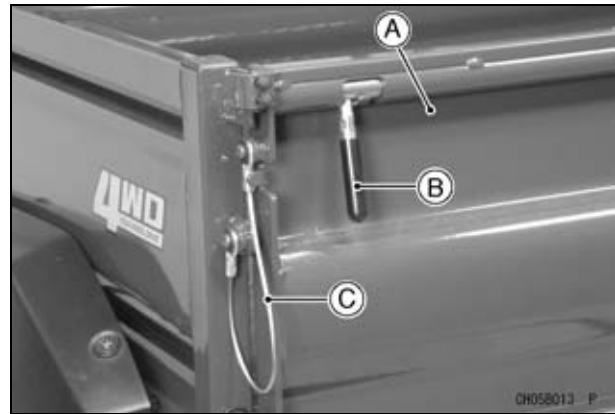

A. Tailgate
B. Latch Handle
C. Cable

Cargo Bed

The cargo bed can be tilted by releasing the latches on right side, and then lifting the bed with the handgrip. Before tilting the cargo bed, park on a firm level surface and set the parking brake.

After lifting the bed, support the bed in the tilted position with the supporting rod provided on the bottom of the cargo bed.

To lower the bed, check to be sure the area under the cargo bed is clear, then carefully lower the bed into position.

Latch the latch and check that the bed is properly locked into place. Do not leave the cargo bed unlatched.

Do not drive the vehicle with the front end of the cargo bed raised or unlatched.

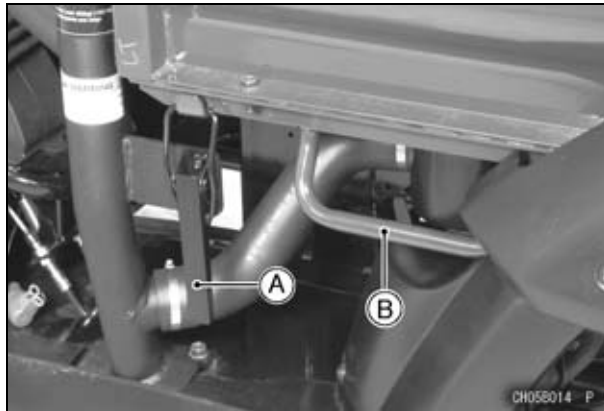

A. Latch
B. Handgrip



A. Supporting Rod

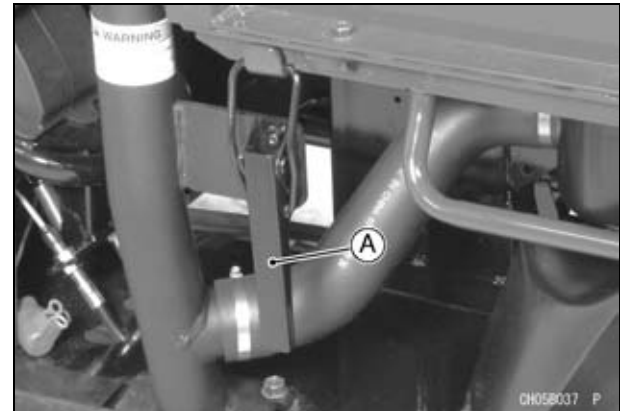

A. Latch (locked position)

38 GENERAL INFORMATION

NOTICE

Do not carry more than 363 kg (800 lb) in the cargo bed.

⚠ WARNING

- **Overloading, failure to properly secure cargo, or improper use of the cargo bed can cause changes in handling which can lead to an accident. Follow guidelines provided in the “LOADING INFORMATION” chapter.**
- **Passengers riding in the cargo bed can be tossed about or even thrown out causing serious injury or death. Do not install seating or carry passengers in the cargo bed.**
- **Driving with the cargo bed tilted may be hazardous. Failure to lower and lock the bed into place may cause severe injury or death. Always lower and latch the bed after tilting.**
- **Lifting and lowering the bed could be dangerous. Be careful not to catch any part of your body, such as hands or arms, between the bed and ROPS or vehicle frame when lifting and lowering the bed.**

Fuel Tank

The fuel tank is mounted under the right side of the seat. The gasoline octane rating listed is recommended. Use only fresh gasoline with the recommended octane rating from an uncontaminated source to insure proper running of your vehicle. Avoid filling the tank in the rain or where heavy dust is blowing, so that the fuel does not get contaminated.



A. Fuel Tank

NOTICE

Always clean dirt/mud/debris/water from the fuel tank cap and surrounding area prior to filling the tank to prevent dirt/mud/debris/water from entering the fuel tank. Accumulation of moisture or sediment in the fuel system can restrict the flow of fuel and cause fuel pump and/or engine damage.

⚠ WARNING

Gasoline is extremely flammable and can be explosive under certain conditions, creating the potential for serious burns. Turn the ignition switch to "OFF". Do not smoke. Make sure the area is well-ventilated and free from any source of flame or sparks; this includes any appliance with a pilot light. Never fill the tank completely to the top. If the tank is filled completely to the top, heat may cause the fuel to expand and overflow through the vents in the tank cap. After refueling, make sure the tank cap is closed securely. If gasoline is spilled on the fuel tank, wipe it off immediately.

Fuel Requirements:

Fuel Type

This vehicle is certified to operate on unleaded gasoline only.

Octane Rating Method	Minimum Rating
Antiknock Index $\frac{(\text{RON} + \text{MON})}{2}$	87

NOTICE

If engine "knocking" or "pinging" occurs, use a different brand of gasoline of a higher octane rating. If this condition is allowed to continue it can lead to severe engine damage. Gasoline quality is important. Fuels of low quality or not meeting standard industry specifications may result in unsatisfactory performance. Operating problems that result from the use of poor quality or nonrecommended fuel may not be covered under warranty.

Fuels Containing Oxygenates

Gasoline frequently contains oxygenates (alcohols and ethers) especially in areas of the U.S. and Canada which are required to sell such reformulated fuels as part of a strategy to reduce exhaust emissions.

40 GENERAL INFORMATION

The types and volume of fuel oxygenates approved for use in unleaded gasoline by the U.S. Environmental Protection Agency include a broad range of alcohols and ethers, but only two components have seen any significant level of commercial use.

Gasoline/Alcohol Blends — Gasoline containing up to 10% ethanol (alcohol produced from agricultural products such as corn), also known as “gasohol” is approved for use.

NOTICE

Avoid using blends of unleaded gasoline and methanol (wood alcohol) whenever possible, and never use “gasohol” containing more than 5% methanol. Fuel system damage and performance problems may result.

Gasoline/Ether Blends — The most common ether is methyl tertiary butyl ether (MTBE). You may use gasoline containing up to 15% MTBE.

NOTE

○ *Other oxygenates approved for use in unleaded gasoline include TAME (up to 16.7%) and ETBE (up to 17.2%). Fuel containing these oxygenates can also be used in your Kawasaki.*

NOTICE

Never use gasoline with an octane rating lower than the minimum specified by Kawasaki.

Never use “gasohol” with more than 10% ethanol, or more than 5% methanol. Gasoline containing methanol must also be blended with cosolvents and corrosion inhibitors.

Certain ingredients of gasoline may cause paint fading or damage. Be extra careful not to spill gasoline or gasoline oxygenate blends during refueling.

When not operating your Kawasaki for 30 to 60 days, mix a fuel stabilizer (such as STA-BIL) with the gasoline in the fuel tank. Fuel stabilizer additives inhibit oxidation of the fuel which minimizes gummy deposits.

Never store this product with “gasohol” in the fuel system. Before storage it is recommended that you drain all fuel from the fuel tank. See the “STORAGE” chapter in this manual.

Glove Compartment

A glove compartment is provided at the each end of the dashboard. Store only light items to avoid damage to the inside of the compartments. Release the plug in the bottom of the left and right glove compartments to remove any water that may have entered. Do not put one which must not get wet or dirty in it.



A. Left Glove Compartment



A. Right Glove Compartment

42 GENERAL INFORMATION

Front Cargo Compartment

The front cargo compartment is located under the front cargo hood. Store only light-weight items in it to avoid damage to the inside of the compartment. Do not put items which must not get wet or dirty inside.



A. Front Cargo Compartment

Hood Opening

Push the hood release latch and raise the hood until it locks.



A. Latch Release Knob

NOTE

- When the hood is hard to open, pull and lift up the front hood center portion with pulling the knob to open the front hood.

Hood Closing

Close the hood until it locks.

- After the hood is closed, push the two edges of the hood to ensure the hood is latched.
- Pull up the front ends of the hood to make sure latches are securely locked.

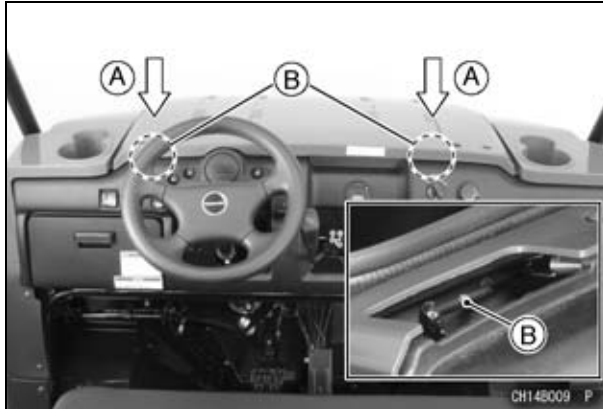

- A. Push here
B. Latches

⚠ WARNING

An open front cargo hood can distract or impair visibility of the operator, causing loss of vehicle control and potential serious injury or death.

Latch the hood securely before operating the vehicle.

Horn Button

Push the horn button to sound the horn.



A. Horn Button

44 GENERAL INFORMATION

Ignition Switch

This is a three-position, key-operated switch. The key can be removed from the switch only when it is in the “OFF” position.

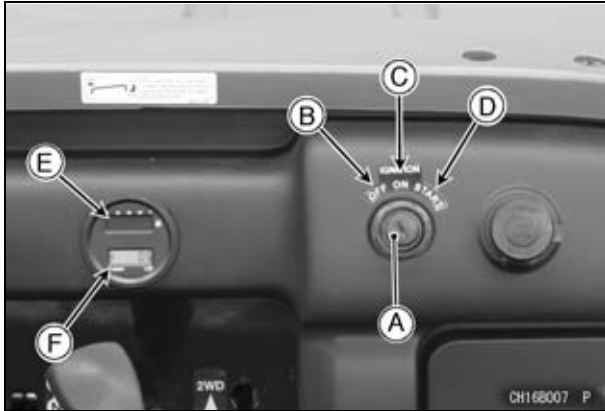

- A. Ignition Switch
- B. “OFF” position
- C. “ON” position
- D. “START” position
- E. Fuel Gauge
- F. Hour Meter

OFF	Engine off. All electrical circuits off.
ON	All electrical equipment can be used. Fuel gauge works.
START	Electric starter is engaged by holding ignition switch key in this position, only when gear shift lever is in “N” (neutral) position. Upon release, key will return to “ON” position. Hour meter works.

NOTICE

Do not operate the starter continuously for more than 5 seconds, or the starter will overheat and the battery power will drop temporarily. Wait 15 seconds between each operation of the starter to let it cool and for the battery to recover power.

Do not turn the ignition switch key to the “START” position with the engine running, or damage to the starter can result.

NOTE

- *The vehicle is equipped with a starter lockout switch. This switch prevents the electric starter from operating when the gear shift lever is in the “H” (High), “L” (Low; KAF620M only) or “R” (Reverse) position.*

Keys

This UV has a key, which is used for the ignition switch, and one spare key. Included with the key is a key number, which is stamped on the key itself. Record the key number in the space provided and store the number in a safe place.

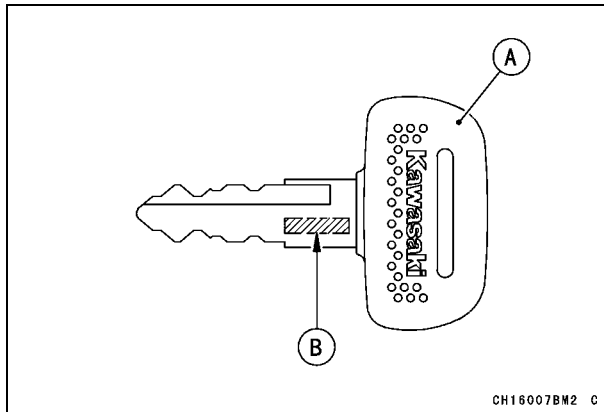

A. Key

B. Key Number

Write your key number here.

In the event you lose your keys, you will need the key number to have a duplicate made. If you cannot locate your key number, contact the dealer where you purchased your Kawasaki UV. It's possible the dealer may have the number in its records. If the key number is lost completely, you will need to replace the ignition switch and all other locks operated by that key.

Contact your Kawasaki dealer to purchase additional spare keys either using your original key as a master or using the key code on the tag or your key. Store one key at home and keep another spare in your wallet or riding gear, in case the original is lost.

Fuel Gauge/Hour Meter

Fuel Gauge (LED) –

The fuel in the fuel tank is shown by the number of segments displayed.

When the fuel tank is full, all the segments are displayed. As the fuel level in the tank goes down, the segments disappear one by one from F (full) to E (empty). The lowest segment blinks in the fuel gauge (LED) when approximately 5.0 L (1.3 US gal) of usable fuel remains.

Refuel at the earliest opportunity if the most bottom segment of the fuel gauge (LED) blinks.

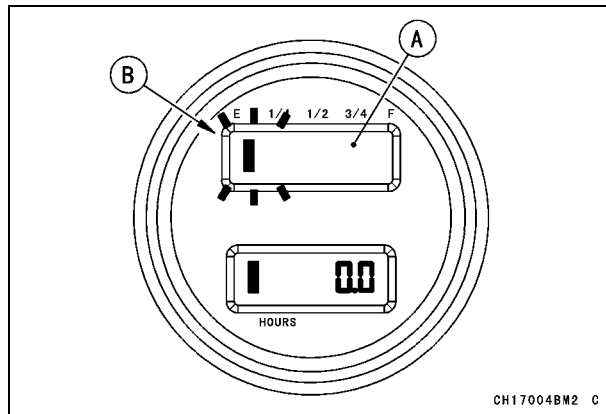

A. Fuel Gauge (LED)

B. Blink

Hour Meter –

The hour meter shows the total hours that the vehicle has been operated. This meter cannot be reset.

NOTE

- *The data is maintained even if the battery is disconnected.*
- *The hour meter shows the operating hours to a maximum of 5 digits. The value is shown to the nearest 0.1 hr until the total reaches 10 000 hrs after which the meter counts in complete hours only.*
- *When the figures come to 99999, they turn back to 0.0 and start counting upward again when the vehicle is operated.*

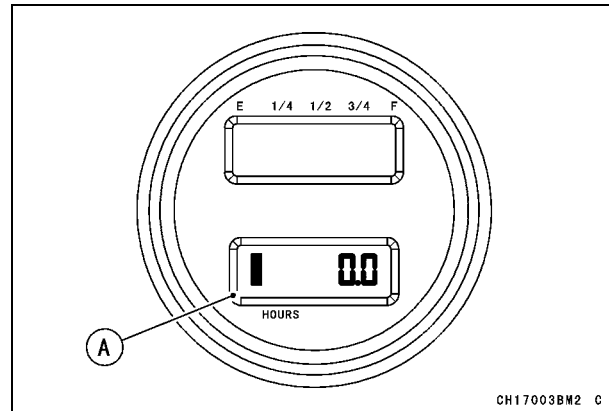

A. Hour Meter

Shift Levers

This vehicle is equipped with three different shift levers: the gear shift lever, the 2WD-4WD shift lever (KAF620M only) and the differential shift lever.

Gear Shift Lever

The gear shift lever is located on the dashboard, to the right of the steering shaft. The gear shift lever has four (KAF620M) or three (KAF620P) positions: “H” (High), “L” (Low; KAF620M only), “N” (Neutral), and “R” (Reverse).

Model	Gear Position
KAF620M	“H” (High), “L” (Low), “N” (Neutral), “R” (Reverse)
KAF620P	“H” (High), “N” (Neutral), “R” (Reverse)

Make certain that the vehicle is completely stopped and the engine is idling before shifting from “H” (High), “L” (Low; KAF620M only) to “R” (Reverse) or vice versa. Move the gear shift lever up or down as indicated on the label next to the shift lever.

Refer to the “Reversing Gears” section in the “How to Operate” chapter.

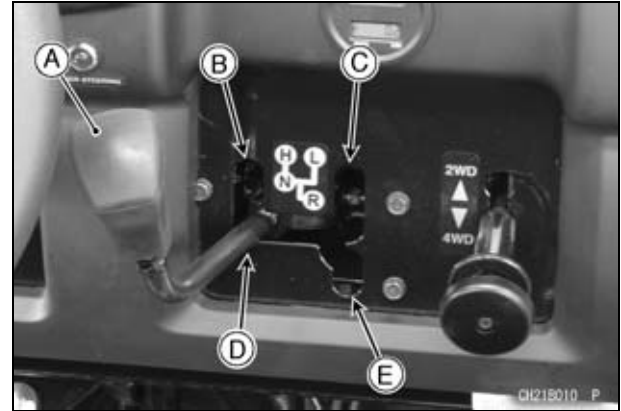

- A. Gear Shift Lever
- B. “H” (High) Position
- C. “L” (Low) Position (KAF620M only)
- D. “N” (Neutral) Position
- E. “R” (Reverse) Position

NOTICE

Do not shift from “H” (High), “L”(Low; KAF620M only) to “R” (Reverse) and vice versa when the vehicle is moving or with the engine running above idling speed, or the transmission could be damaged.

48 GENERAL INFORMATION

The KAF620M is equipped with a sub-transmission to allow maximum transmission efficiency. Use the low gearing for maximum torque at low speeds, for climbing hills, pulling a trailer, or keeping constant low speeds for agricultural use. The high gearing raises the speed range for ordinary off-highway use. Stop the vehicle before moving the Hi-Lo shift lever.

NOTICE

Use of the high range for heavy loads, climbing hills, and pulling a trailer can lead to premature wear of the torque converter belt and pulleys. Use low range for these conditions.

Refer to the “Hi-Lo Shifting” section in the “How to Operate” chapter.

2WD-4WD Shift Lever (KAF620M)

This vehicle can be operated either in “2WD” or “4WD”.

The 2WD-4WD shift lever is located on the dashboard, to the right of the steering shaft. Move the 2WD-4WD shift lever up or down while pulling the stopper as indicated on the label next to the left of the lever.

Refer to the “2WD-4WD Shifting” section in the “How to Operate” chapter.

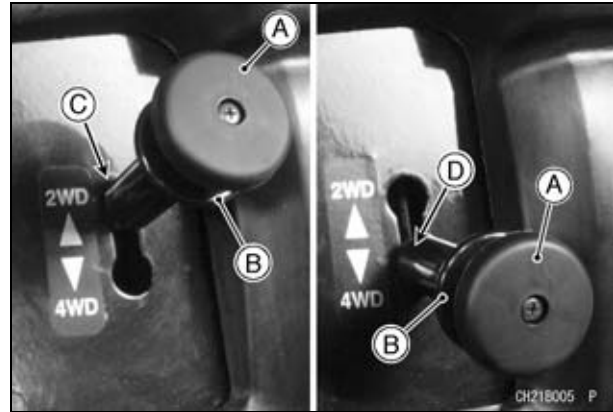

- A. 2WD-4WD Shift Lever**
- B. Stopper**
- C. “2WD” Position**
- D. “4WD” Position**

Differential Shift Lever

This vehicle is equipped with a dual-mode rear differential. The differential shift lever is located on the dashboard, to the left of the steering shaft. Move the shift lever up or down while pulling the stopper as indicated on the label next to the shift lever.

Refer to the “Shifting the Differential” section in the “How to Operate” chapter.

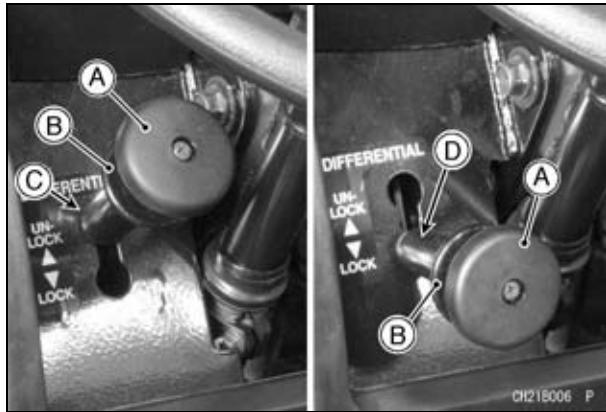

- A. Differential Shift Lever
- B. Stopper
- C. Differential (Unlocked–Axle) Mode Position (UN–LOCK)
- D. Locked-Axle Mode Position (LOCK)

Parking Brake Lever

The parking brake lever is located at the left side of the seat. Pull the lever up and to the rear to apply the parking brake.

To release, push in and hold the knob on the end of the lever and push the lever all the way down. Spring pressure helps return the lever to the released position.

Be sure to release the parking brake before driving off. Failure to do so may result in poor performance and premature wearing of the rear brakes and belt converter system.

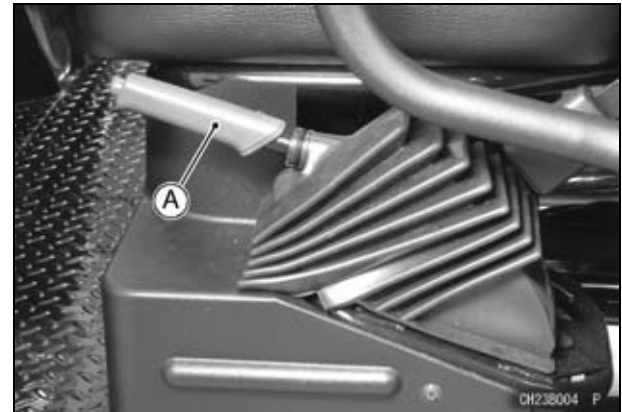

- A. Parking Brake Lever

50 GENERAL INFORMATION

WARNING

If the vehicle should move after it is parked, it might be damaged or cause injury. Be sure to apply the parking brake before leaving the vehicle.

Seat

The seat can be raised for vehicle maintenance and adjustment.

- Pull up on the rear edge of the seat.

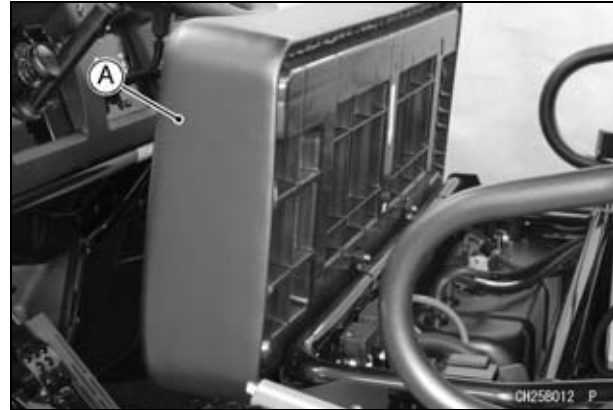

A. Seat (Raised Position)

Seat Belts

The vehicle is equipped with lap-style seat belts for both operator and passenger. Always wear the seat belts when operating and riding in the vehicle.

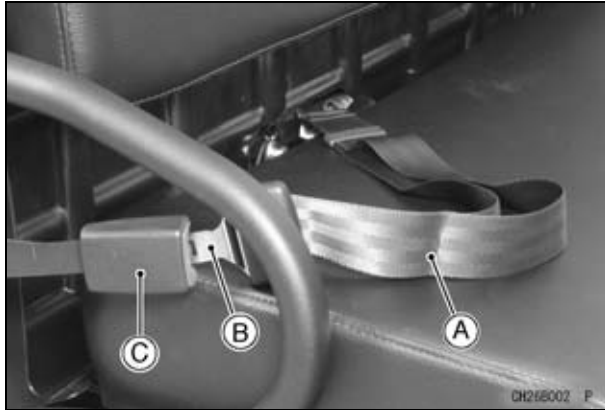

- A. Seat Belt
- B. Latch Plate
- C. Buckle

⚠ WARNING

Not wearing a seat belt, or wearing one improperly can result in serious injury or death in the event of an accident. Make certain the operator and passenger always wear their seat belts properly.

⚠ WARNING

Operator and passenger must be able to place both feet flat on the floorboards while seated upright with their backs against the seatbacks.

To wear the seat belt properly, follow this procedure:

1. Place the belt across your lap as low on your hips as possible taking care that the belt is not twisted.
2. Push the latch plate into the buckle until it clicks.
3. Adjust the seat belt for a **SNUG FIT**.

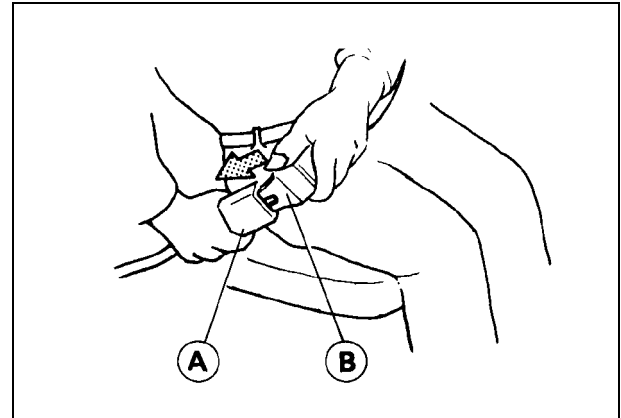

- A. Buckle
- B. Latch Plate

52 GENERAL INFORMATION

To tighten the belt, pull on the end of the belt coming from the latch plate. To loosen the belt, pull the latch plate at a right angle to the belt.

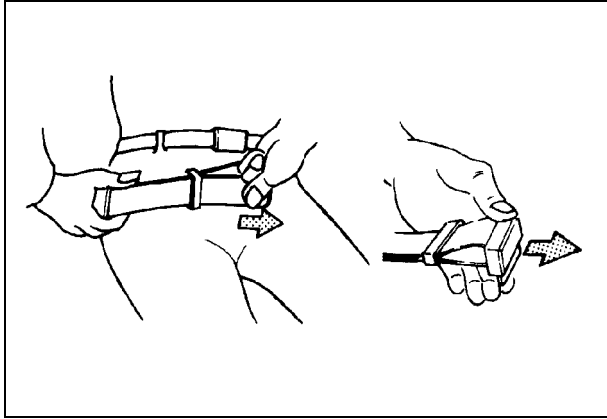

WARNING

Too much seat belt slack could reduce its protection effectiveness in an accident. Always adjust the seat belt for a **SNUG FIT**. To tighten the belt, pull on the end of the belt coming from the latch plate. To loosen the belt, pull the latch plate at a right angle to the belt.

To unfasten the belt, press the red button in the buckle.



A. Red Button

Throttle Pedal

The throttle pedal is the right pedal on the floor board. Push the pedal down to increase engine speed. Spring pressure returns the pedal to the rest position when released. Always check that the throttle pedal returns normally before starting the engine. In addition, there must be adequate throttle pedal play and correct throttle stop position adjustment. Refer to the “Maintenance and Adjustment” chapter for the throttle pedal adjustment procedure.



A. Throttle Pedal

Trailer Hitch Bracket

This vehicle is equipped with a bracket for a trailer hitch. Trailer towing equipment is not supplied with this vehicle.

To avoid injury and property damage, observe the following precautions:

WARNING

Improper towing of a loaded trailer could cause an accident resulting in serious injury or death.

Never carry a passenger in a trailer. Never load more than 50 kg (110 lb) tongue weight on the towing bracket. Do not operate the vehicle faster than 16 km/h (10 mph) when towing. Remember that towing a trailer increases braking distance. Do not tow more than 545 kg (1 200 lb) trailer weight (trailer plus cargo weight). Attach the trailer to the trailer hitch bracket only; do not attach a trailer to any other location.

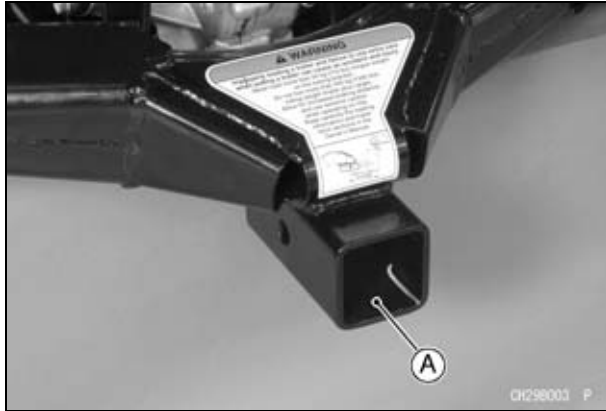

A. Trailer Hitch Bracket

Winch Installation

This vehicle is equipped with a bracket for a winch below the radiator. The winch is not supplied with this vehicle.

To avoid injury and property damage, observe the following precautions:

⚠ WARNING

Improper installation or operation of a winch could cause an accident resulting in serious injury or death. Do not install or operate a winch without reading and understanding the operator's manual supplied with the winch.

Installing procedure for a winch

1. You can see the bracket attached to a cross-member.

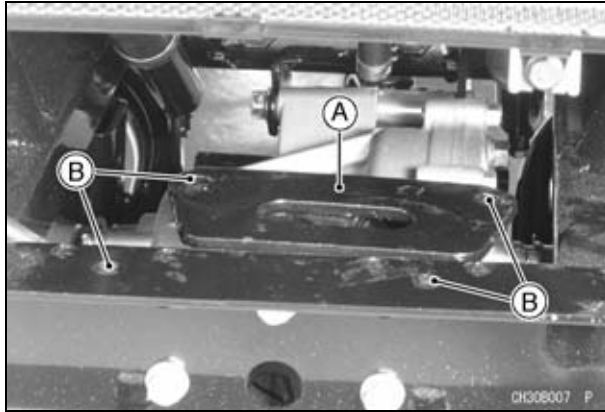

A. Winch Bracket

B. Bolt Holes

2. Follow a manual to be supplied by the winch maker for installing the winch and other accessory as necessary.
3. After installing the winch, be sure to re-install the bumper and bumper cover.

HOW TO OPERATE

Daily Checks

Check the following items each day before operation. The time required is minimal, and habitual performance of these checks will help ensure safe, reliable operation.

If any irregularities are found during these checks, refer to the MAINTENANCE AND ADJUSTMENT chapter, see your dealer, or refer to the Service Manual for the action required to return the vehicle to a safe operating condition.

WARNING

Failure to perform these checks before operation may result in serious damage or an accident. Always perform daily checks before operation.

DANGER

Exhaust gas contains carbon monoxide, a colorless, odorless poisonous gas. Inhaling carbon monoxide can cause serious brain injury or death. Do not run the engine in enclosed areas. Operate only in a well-ventilated area.

Fuel	Enough fuel in tank, no leaks.
Engine oil	Oil level between "F" and "L" lines on the dipstick (when engine is cold), no leaks.
Air Cleaner	Check the restriction gauge for the red band in the window.
Tires	Air pressure (when cold):

Front	69 kPa (0.7 kgf/cm ² , 10 psi)
Rear	167 kPa (1.7 kgf/cm ² , 24 psi)

Check for cuts, cracks, damage, or excessive wear.
Check for any imbedded stones or other foreign particles in tread.

Front Final Gear Case	No oil leaks.
Transmission Case Oil	Oil level between “H” and “L” lines on the dipstick, no leaks.
Coolant	Coolant level between level lines (when engine is cold), no leaks.
Throttle	Throttle pedal free play 5 ~ 10 mm (0.2 ~ 0.4 in.). Throttle pedal operates smoothly and returns to rest position when released.
Steering	Steering wheel free play 0 ~ 20 mm (0 ~ 0.8 in.). Action smooth without excessive play, rough spots, or strange noises.
Brakes	Check for braking effectiveness (while test running). Brake pedal free play 2 ~ 10 mm (0.1 ~ 0.4 in.). Brake fluid level between level lines, no leaks. Parking brake lever travel: 8 ~ 12 clicks.
Electrical Equipment	All lights and horn work. Check for dirt on or damage to lights.

Starting the Engine

DANGER

Exhaust gas contains carbon monoxide, a colorless, odorless poisonous gas. Inhaling carbon monoxide can cause serious brain injury or death. Do not run the engine in enclosed areas. Operate only in a well-ventilated area.

- Wear the seat belts (both operator and passenger).
- Apply the parking brake.
- Put the gear shift lever in the “N” (Neutral) position.
- Put the ignition switch key in the switch.
- Turn the ignition switch key to the “START” position to activate the electric starter. Repeat until the engine starts.

NOTICE

Do not operate the electric starter continuously for more than 5 seconds, or the starter may overheat and the battery power will drop temporarily. Wait 15 seconds between each operation of the starter to let it cool and for battery power to recover.

NOTE

- *The vehicle is equipped with a starter lockout switch. This switch prevents the electric starter from operating when the gear shift lever is in the “H” (High) , “L” (Low; KAF620M only) or “R” (Reverse) position.*

Jump Starting

If your vehicle's battery is "run down," it should be removed and charged. If this is not practical, a 12 volt booster battery and jumper cables may be used to start the engine.

DANGER

Battery acid generates hydrogen gas which is flammable and explosive under certain conditions. It is present within a battery at all times, even in a discharged condition. Keep all flames and sparks (cigarettes) away from the battery. Wear eye protection when working with a battery. In the event of battery acid contact with skin, eyes, or clothing, wash the affected areas immediately with water for at least 5 minutes. Seek medical attention.

Connecting Jumper Cables

- Make sure the ignition switch key is turned to "OFF".
- Remove the cover under the left end of the front seat.



A. Cover

60 HOW TO OPERATE

- Connect a jumper cable from the positive (+) terminal of the booster battery to the positive (+) terminal of the vehicle battery.

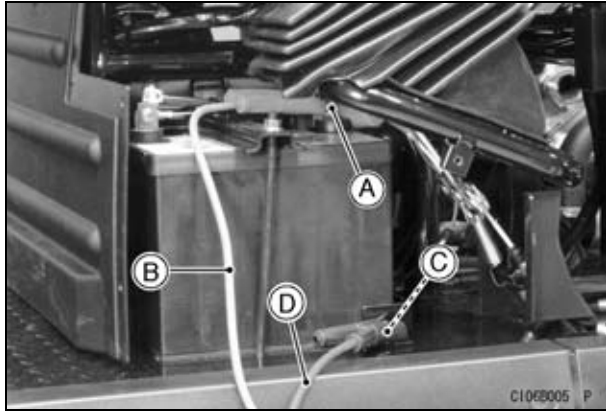

- A. Vehicle Battery Positive (+) Terminal
- B. From Booster Battery Positive (+) Terminal
- C. Unpainted Metal Surface
- D. From Booster Battery Negative (-) Terminal

- Connect another jumper cable from the negative (-) terminal of the booster battery to an unpainted metal surface on your vehicle. Do not use the negative (-) terminal of the battery.

DANGER

Batteries contain sulfuric acid that can cause burns and produce hydrogen gas which is highly explosive. Do not make this last connection at the fuel system or battery. Take care not to touch the positive and negative cables together, and do not lean over the battery when making this last connection. Do not connect to a frozen battery. It could explode. Do not reverse polarity by connecting positive (+) to negative (-), or a battery explosion and serious damage to the electrical system may occur.

- Follow the standard engine starting procedure.

NOTICE

Do not operate the starter continuously for more than 5 seconds, or the starter overheat and the battery power will drop temporarily. Wait 15 seconds between each operation of the starter to let it cool and for the battery to recover power.

- After the engine starts, disconnect the jumper cables. Disconnect the negative (-) cable from the vehicle first.
- Reinstall the battery holder and the cover.

Moving Off

- Depress the brake pedal.
- Put the gear shift lever into the “H” (High) or “L” (Low; KAF620M only) position.
- Release the parking brake.
- Gradually increase engine speed by pressing on the throttle pedal.

NOTE

- *Practice starting and stopping (using the brakes) until you are familiar with the controls.*

Braking

NOTE

- *When the throttle pedal is released completely and the engine speed drops near an idle, the vehicle has no engine braking. This is caused by the vehicle’s automatic transmission which releases the engine at very low speed to prevent it from stalling. Employ the brakes to control the vehicle’s speed.*
- Release the throttle pedal completely.
- Press on the brake pedal evenly and firmly.

WARNING

Carrying cargo or towing a trailer will increase braking distances. Failure to allow for increased braking distance may result in accident and injury. Always allow more distance to stop when carrying cargo or towing a trailer.

Stopping the Engine

- Release the throttle pedal completely.
- Put the gear shift lever into the “N” (Neutral) position.
- Apply the parking brake to help prevent the vehicle from rolling.
- Turn the ignition switch key to the “OFF” position.

Parking the Mule

 **WARNING**

Operating or parking the vehicle near flammable materials can cause a fire, and can result in property damage or severe personal injury.

Do not idle or park your vehicle in an area where tall or dry vegetation, or other flammable materials could come into contact with the muffler or exhaust pipe.

 **WARNING**

The engine and exhaust system get extremely hot during normal operation and can cause serious burns.

Never touch a hot engine, exhaust pipe, or muffler during operation or after stopping the engine.

- Stop the vehicle on a level surface.

NOTICE

Avoid parking on steeply inclined surfaces.

- When the engine has stopped, apply the parking brake to help prevent the vehicle from rolling.

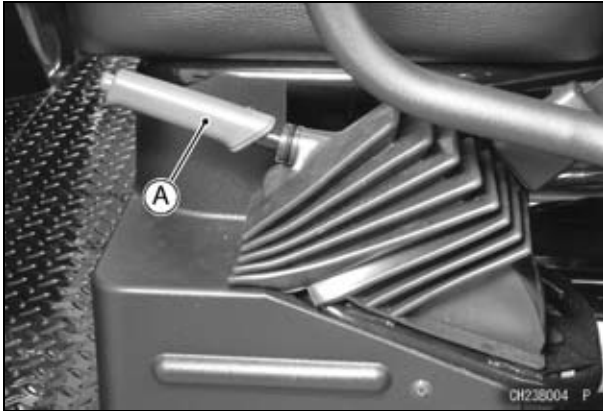

A. Parking Brake Lever

⚠ WARNING

If the vehicle should move after it is parked, it might be damaged or cause injury. Be sure to apply the parking brake before leaving the vehicle.

- Remove the ignition switch key to prevent unauthorized use.
- When parking inside a garage or other structure, be sure the structure is well ventilated and the vehicle is not close to any source of flame or sparks. This includes any appliance with a pilot light.

⚠ WARNING

Gasoline is extremely flammable and can be explosive under certain conditions, creating the potential for serious burns. Make sure the area is well ventilated and free from any source of flame or sparks, including the pilot light of any appliance.

Hi-Lo Shifting (KAF620M)

Shifting to Low Range

- Stop the vehicle completely.
- For easy Hi-Lo shifting, put the gear shift lever in neutral.
- Move the shift lever “L” (Low) position.

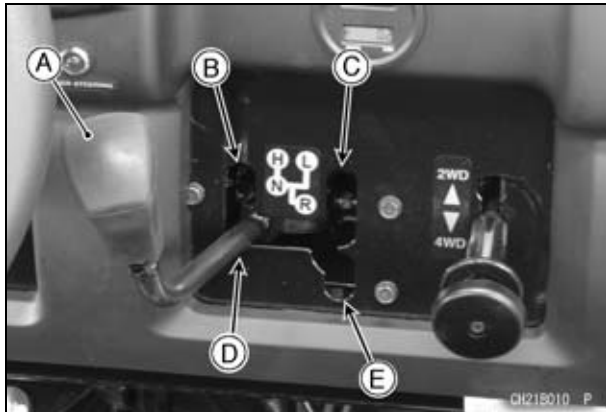

- A. Gear Shift Lever
- B. “H” (High) Position
- C. “L” (Low) Position
- D. “N” (Neutral) Position
- E. “R” (Reverse) Position

Shifting to High Range

- Stop the vehicle completely.
- Put the gear shift lever in neutral.
- Move the shift lever “H” (High) position.

NOTE

- *Before shifting make certain that the vehicle is completely stopped. The Hi-Lo shift lever cannot be shifted when the vehicle is in motion.*

Reversing Gears

- Release the throttle pedal, and stop the vehicle.
- When you want to operate the vehicle in reverse, stop the vehicle completely, allowing the engine to slow to idling speed, and move the gear shift lever to the “R” (Reverse) position.

NOTICE
Do not shift from “H” (High) or “L” (Low; KAF620M only) to “R” (Reverse) and vice versa when the vehicle is moving or with the engine running above idling speed, or the transmission could be damaged.

2WD-4WD Shifting (KAF620M)

- Pull the stopper under the 2WD-4WD shift lever knob and while holding it against the knob, move the shift lever to the all way down “4WD”.
- To shift back into “2WD” position, pull and hold the stopper, then move the shift lever all the way up “2WD”.

NOTE

- *When the shift lever is moved from “2WD” to “4WD”, the transmission shifts immediately. When the shift lever is moved from “4WD” to “2WD”, the transmission may not shift all the way into “2WD” until the vehicle has rolled a short distance.*

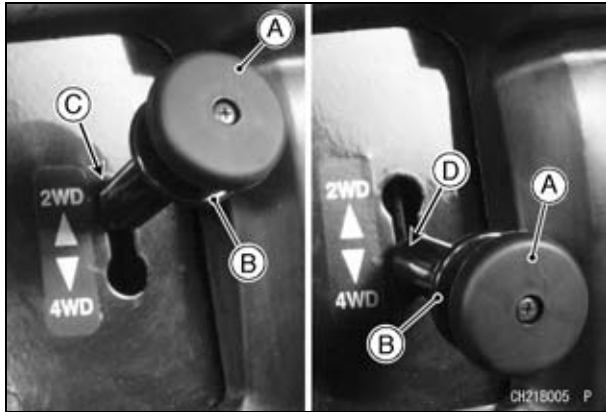

- A. 2WD-4WD Shift Lever
- B. Stopper
- C. "2WD" position
- D. "4WD" position

Shifting the Differential

NOTE

○ Do not operate the differential shift lever if the vehicle is moving faster than 8 km/h (5 mph).

Shifting to Locked-Axle Mode

- Pull the stopper under the differential shift lever knob and while holding it against the knob, move the shift lever all the way down (LOCK).

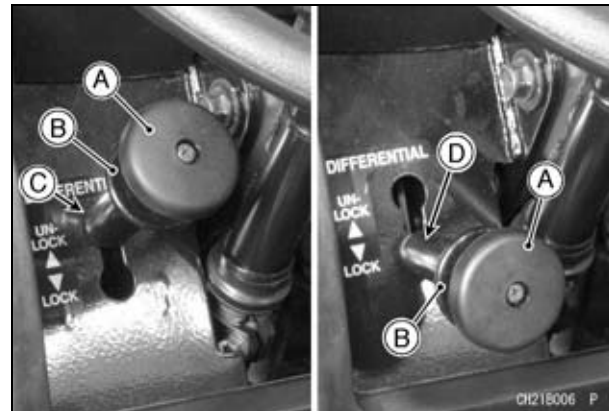

- A. Differential Shift Lever
- B. Stopper
- C. Differential (Unlocked-Axle) Mode Position (UN-LOCK)
- D. Locked-Axle Mode Position (LOCK)

Shifting to Differential (Unlocked-Axle) Model

- Pull and hold the stopper, then move the shift lever all the way up (UN-LOCK).

NOTE

- *When the shift lever is moved, the differential may not immediately lock or unlock until the vehicle has rolled a short distance.*

SAFE OPERATION

Safety is an attitude. Your common sense and good judgement are your best defenses against accident and injury in everything you do. Your safety and the safety of others depends on you and your common sense. Use good judgement in the operation of this or any other motor vehicle.

This vehicle is designed for an operator and one passenger only. Never carry persons in the cargo bed. Refer to the “Loading Information” chapter before operating this vehicle.

Novice operators should practice braking and turning in an open, off-highway area away from other vehicles and persons. The terrain should be flat and free of obstacles, with either a loose or hard dirt surface, but not a mixture of both.

 **WARNING**

Incorrect loading, improper installation or use of accessories, or modification of your vehicle may result in an unsafe operating condition. Before operation, make sure that the vehicle is not overloaded and that you have followed the instructions in the “Loading Information” chapter.

Unfamiliar Terrain

Before driving in a new area be sure to check for hidden obstacles or hazards. Keep your speed down until you know the area well. You must know the terrain you intend to drive on and be familiar with your machine and its handling characteristics. Use existing trails and stay away from hazardous areas such as steep, rocky slopes or swamps. Be cautious when visibility is limited, as you may not be able to see obstacles in your path.

Driving in Reverse

Start the engine following the procedure in the “Starting the Engine” section. Before shifting into reverse, stop the vehicle completely. Refer to the Gear Shift Lever in the “Shift Levers” section and “Reversing Gears” section.

Turn around and look behind you before backing up to be sure there are no obstacles or people in your way. Gradually open the throttle and begin backing up cautiously.

To stop while driving in reverse, close the throttle and gradually apply the brake. Avoid sudden application of the brake.

<i>NOTICE</i>
Do not operate the gear shift lever to change gears while driving the vehicle in reverse, or the transmission may be damaged.

Remember:

- Look behind you before backing up.
- Open the throttle gradually.
- To stop, gradually apply the brake.

Driving in “4WD” (KAF620M)

“4WD” gives greater traction when you are climbing steep inclines, or driving on bumpy, sandy or snowy surfaces. It also helps break loose, with the differential locked under certain circumstances, for example, when the vehicle is stuck in the mud. If maximum torque is needed in these situations, shift into the low position with the shift lever. Refer to the “Shift Levers” section and “2WD-4WD Shifting (KAF620M),” “Shifting the Differential,” and “Hi-Lo Shifting (KAF620M)” sections.

NOTE

○ *Do not drive in “4WD” on paved surfaces, because it increases tire and drive train wear and makes the steering feel tight.*

Remember:

- Use “4WD” on steep inclines or loose surfaces, or when stuck in the mud, with the differential locked if necessary.
- For maximum torque shift into low range.
- Do not drive in “4WD” on paved surfaces.

70 SAFE OPERATION

Turning the Vehicle

The vehicle will turn in a smaller radius with the differential unlocked (in differential mode). In this mode, the rear wheels can turn at different speeds allowing the vehicle to turn tighter and more smoothly. Even in this mode, however, avoid sharp turns to keep the vehicle from tipping. Reduce vehicle speed before entering the turn and use the throttle to maintain an even speed through the turn.

 **WARNING**

In the differential mode, if either rear wheel leaves the ground it will spin freely, and the wheel on the ground will transmit very little power. When a spinning wheel touches the ground, it may grab abruptly, causing the operator to lose control. Do not make sharp turns, even in the differential mode, in order to avoid loss of control or tipping.

Remember:

- Slow down before entering the turn.
- Maintain an even speed through the turn.

Hills

As with any motor vehicle, loading of the vehicle, and the surface and steepness of the hill are among the critical considerations in climbing, descending or traversing hills. Use extreme caution on hills. Keep in mind that loading changes a vehicle's center of gravity and that the higher the center of gravity, the more likely the vehicle is to tip on uneven surfaces. Slippery, loose, or bumpy surfaces on hills are especially hazardous. Some hills are just too steep to climb. Always use common sense and practice good judgement.

Climbing Hills

Do not attempt to climb hills or steep inclines until you have mastered the controls and basic operating maneuvers of this vehicle. Always go straight uphill and, if the incline is steep and/or the surface is loose, use “4WD” with the differential locked for greater traction, and in low range for maximum torque.

Avoid hills with slippery sides that will cause you to lose traction. Do not climb hills where you cannot see far enough ahead. If you cannot see what is on the other side of the crest of a hill, slow down until you can get a clear view. Don't apply power suddenly while climbing, or the front wheels might rise off the ground. If the vehicle does not have enough power to reach the top of the hill and stalls, allow the vehicle to roll slowly straight back down the hill controlling its descent with the brakes. Leave the gear shift lever in the “H” (High) or “L” (Low; KAF620M) position until you stop at the bottom of the hill.

 **WARNING**

Riding sideways across a hill may cause the vehicle to overturn, causing severe injury or death. Do not turn sideways to the hill.

Remember:

- Some hills are too steep. Use common sense.
- Never ride past your limit of visibility. If you can't see what is on the other side of the crest of a hill, slow down until you can get a clear view.
- Don't turn sideways to the hill.
- If you get stuck on a hill, roll slowly straight back down, using the brake, with the gear shift lever left in the “H” (High) or “L” (Low; KAF620M) position.

NOTE

- *When the throttle pedal is released completely and the engine speed drops near an idle, the vehicle has no engine braking. This is caused by the vehicle's automatic transmission which releases the engine at very low speed to prevent it from stalling. Use the brakes to control the vehicle's speed.*

72 SAFE OPERATION

Descending Hills

Slow down or stop at the top of a hill so you can pick a straight, safe path for descent to avoid any obstacles. Normally you should descend straight down a hill since driving at an angle could cause the vehicle to lean to one side and possibly tip over. Proceed slowly and cautiously. Apply the brake as necessary. Be careful if the surface is loose because the tires are more likely to skid and braking effectiveness will be reduced.

Turning while descending a slope must be done very carefully and gradually to avoid tipping the vehicle over.

 **WARNING**

Riding sideways across a hill may cause the vehicle to overturn, causing severe injury or death. Do not turn sideways to the hill.

Remember:

- Stop and look for obstacles before descending a hill.
- Go straight downhill.
- Go slowly.
- If you must turn, do so carefully and gradually.

NOTE

- *When the throttle pedal is released completely and the engine speed drops near an idle, the vehicle has no engine braking. This is caused by the vehicle's automatic transmission which releases the engine at very low speed to prevent it from stalling. Use the brakes to control the vehicle's speed.*

Traversing Hillsides

When driving across the side of a hill, reduce vehicle speed and exercise extreme caution to prevent tipping or loss of control. Avoid hills with slippery sides that will cause you to lose traction. Also avoid traversing hillsides covered with rocks or other obstacles which may cause you to lose your balance or tip over.

When driving on soft terrain, steer slightly uphill to keep the vehicle on a straight line across the hillside.

If the vehicle begins to tip, steer downhill if possible to regain control.

Sliding and Skidding

Obviously, on slippery or loose surfaces, special care is required. Sliding any vehicle may be hazardous because the wheels may suddenly regain traction and cause the vehicle to tip or overturn. Therefore, never drive “over your head” or when you are unsure or unprepared for the surface.

Often you can correct a skid by turning the wheels in the direction of the skid. Do not apply heavy braking force or accelerate when skidding, since this may cause further loss of control.

Use caution and maintain low speeds to avoid uncontrolled skidding on areas covered with clay, mud, ice, or snow. Use “4WD” (KAF620M) and low (KAF620M) range gearing efficiently. These conditions are particularly hazardous when descending a hill or making a turn. Remember that this vehicle is not for use on public streets, roads, or highways.

Remember:

- Be especially careful on very slippery surfaces.
- Don't drive on public streets, roads, or highways.

74 SAFE OPERATION

Driving through Water

Avoid driving through water whenever it is possible. When driving across shallow water, choose a location to enter and exit the water where the banks are not too steep or slippery. Check before entering for rocks, holes or other obstacles which may cause you to overturn or become stuck or submerged.

Observe the following rules for operating the vehicle in water.



A. Axle Cap

⚠️ WARNING

Operating the vehicle in rivers or streams where water is flowing quickly can cause the tires to lose traction and allow the vehicle to be swept into the current. Never operate the vehicle in fast-flowing water or in water deeper than the bottom edge of the axle caps.

After prolonged exposure to water, the wheel bearings may require relubrication or replacement.

Wash the vehicle in fresh water if it has been exposed to salt water or operated in muddy conditions.

⚠️ WARNING

Wet brakes provide greatly reduced efficiency and could lead to an accident and injury. After operation in water, always apply the brakes long enough for friction to dry the linings. Also, the brake that gets wet may wear out faster. Check for brake wear more frequently if the vehicle is used in water.

Remember:

- Avoid driving through water whenever possible.
- Don't drive in deep and fast moving water.
- Dry out the brakes.

MAINTENANCE AND ADJUSTMENT

The maintenance and adjustments outlined in this chapter are easily carried out and must be done in accordance with the Periodic Maintenance Chart to keep the Mule in good running condition. **The initial maintenance is vitally important and must not be neglected.**

If you are in doubt as to any adjustment or vehicle operation, please ask your authorized Kawasaki dealer to check the Mule.

Please note that Kawasaki cannot assume any responsibility for damage resulting from incorrect maintenance or improper adjustment done by the owner.

76 MAINTENANCE AND ADJUSTMENT



Periodic Maintenance Chart

In addition to the following items, always perform the Daily Checks listed in the HOW TO OPERATE chapter.

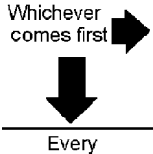

- = Clean, adjust, lubricate, replace parts as necessary.
- D = Service to be performed by an authorized Kawasaki Dealer or someone equally competent.
- * = Service more frequently when operated in mud, dust, or other harsh riding conditions.
- = Emission Related

OPERATION	FREQUENCY			
	Whichever comes first 	First Service	Regular Service	
		After 50 hrs. or 1,000 km (600 miles) of use	Every 250 hrs. or 5,000 km (3,000 miles) of use	Every 500 hrs. or 10,000 km (6,000 miles) of use
ENGINE				
Converter drive belt-inspect*			D	
Converter drive belt deflection-inspect*			D	
Converter driven pulley shoe-inspect*				D
Converter air cleaner element-clean*		●	●	
Converter dust or water-drain*				●
Fuel hoses or pipe and connections-inspect*		D	D	
○ Air cleaner element-clean*		●	●	
○ Air cleaner housing dust or water-drain*		●	●	
○ Spark plug-clean and gap			●	

MAINTENANCE AND ADJUSTMENT 77

OPERATION	FREQUENCY			
	Whichever comes first   Every	First Service	Regular Service	
		After 50 hrs. or 1,000 km (600 miles) of use	Every 250 hrs. or 5,000 km (3,000 miles) of use	Every 500 hrs. or 10,000 km (6,000 miles) of use
○ Valve clearance-inspect		D		D
Engine oil-change*	1 year	●	●	
Oil filter-replace*		●		●
○ Throttle pedal play-inspect		●		●
Throttle link lever-inspect		D	D	
Spark arrester-clean			●	
○ Idle speed-adjust		D	D	
Radiator-clean*		●	●	
Water hoses and connections-inspect*	1 year	D		D
Fuel hose-replace	5 years (D)			
Coolant-change	2 years (D)			
○ Evaporative emission control system-inspect*		●	●	
CHASSIS				
Steering-inspect		●	●	
Steering and axle shaft joint dust boots-inspect		D	D	
Brake pedal play-inspect*		●	●	

78 MAINTENANCE AND ADJUSTMENT

OPERATION	FREQUENCY			
	Whichever comes first   Every	First Service	Regular Service	
		After 50 hrs. or 1,000 km (600 miles) of use	Every 250 hrs. or 5,000 km (3,000 miles) of use	Every 500 hrs. or 10,000 km (6,000 miles) of use
Parking brake lever-inspect		•	•	
Brake hose and pipe-inspect		D	D	
Brake fluid level-inspect		•	•	
Brake wear-inspect*			D	
Tire wear-inspect*		•	•	
Brake light switch-inspect		•	•	
Seat belt-inspect			•	
General lubrication-perform*			D	
Bolts, nuts, and fasteners tightness-inspect		D	D	
Wheel nuts tightness-inspect		•	•	
Front final gear case oil and transmission case oil-change*	1 year	•		•
Brake fluid-change	2 years (D)			
Brake master cylinder cup and dust seal -replace	2 years (D)			
Brake wheel cylinder assembly -replace	2 years (D)			
Brake hose-replace	4 years (D)			

Engine Oil

In order for the engine to function properly, maintain the engine oil at the proper level, and change the oil and oil filter in accordance with the Periodic Maintenance Chart. Not only do dirt and metal particles collect in the oil, but the oil itself loses its lubricative quality if used too long.

WARNING

Vehicle operation with insufficient, deteriorated, or contaminated engine oil will cause accelerated wear and may result in engine seizure, accident, and injury. Check the oil level before each use and change the oil and filter according to the periodic maintenance chart in the owner's manual.

Oil Level Inspection

- If the oil has just been changed, start the engine and run it for several minutes at idle speed. This fills the oil filter with oil. Stop the engine, then wait several minutes until the oil settles.

NOTICE

Racing the engine before the oil reaches every part can cause engine damage.

- If the vehicle has just been used, wait several minutes for all the oil to drain down.
- Park the vehicle on level ground.
- Pull up the dipstick out of the dipstick tube, wipe it dry, and insert the dipstick till it bottoms into the tube securely with the indent upward.

NOTE

- It is necessary to match indent of the dipstick with the mark on the tube to measure the correct amount of oil.

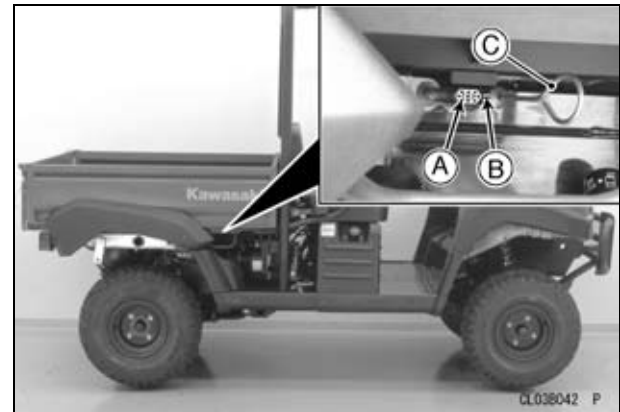

- A. Mark
- B. Groove
- C. Dipstick

80 MAINTENANCE AND ADJUSTMENT

- Pull out the dipstick and check the oil level. The oil level should be between the “F” (Full) and “L” (Low) lines on the dipstick.

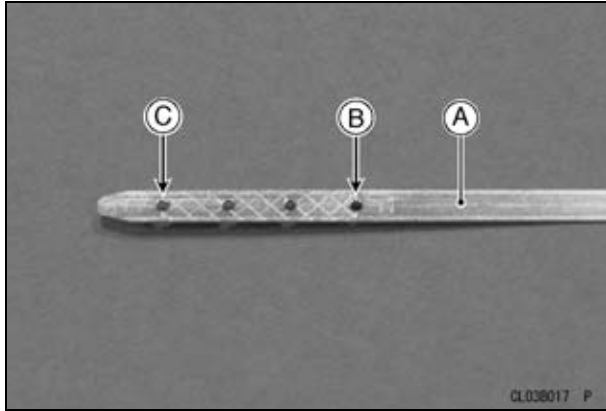

- A. Dipstick**
- B. “F” (Full) Line**
- C. “L” (Low) Line**

- Reinsert the dipstick till it bottoms into the tube securely.
- If the oil level is too high, remove the excess oil, using a syringe or other suitable device.
- If the oil level is too low, unscrew the oil filler cap and add the correct amount of oil. Use the same type and brand of oil that is already in the engine.
- Install the filler cap.

Oil and/or Oil Filter Change

- Warm up the engine thoroughly, and then stop the engine.
- Pull up on the rear edge of the seat.

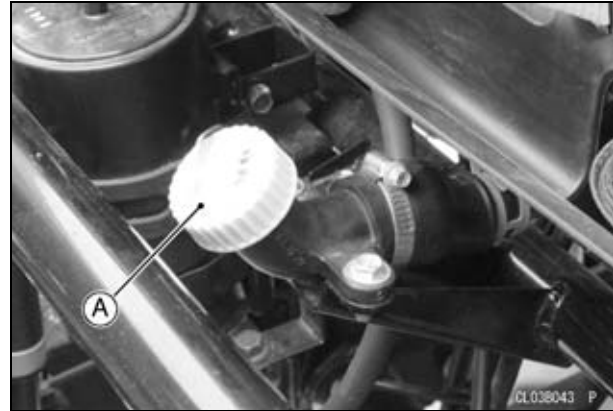

- A. Oil Filter Cap**

- Remove the oil filter cap.
- Place an oil pan beneath the engine.
- Remove the drain plug.

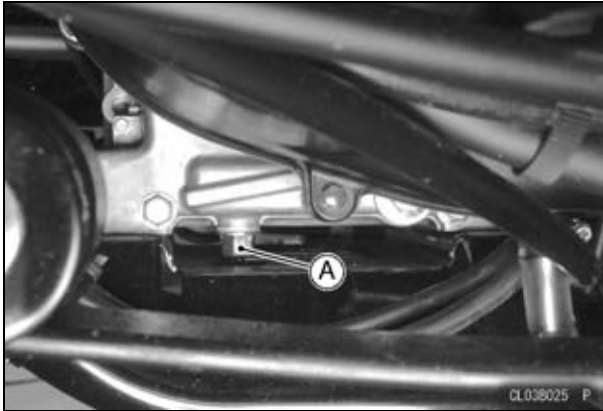

A. Drain Plug

- With the vehicle held level, let the oil drain completely.

WARNING

Engine oil is a toxic substance. Dispose of used oil properly. Contact your local authorities for approved disposal methods or possible recycling.



A. Cartridge

- Apply a thin film of oil to the packing and screw the cartridge in until the packing touches the engine, then turn it 3/4 turn.

82 MAINTENANCE AND ADJUSTMENT

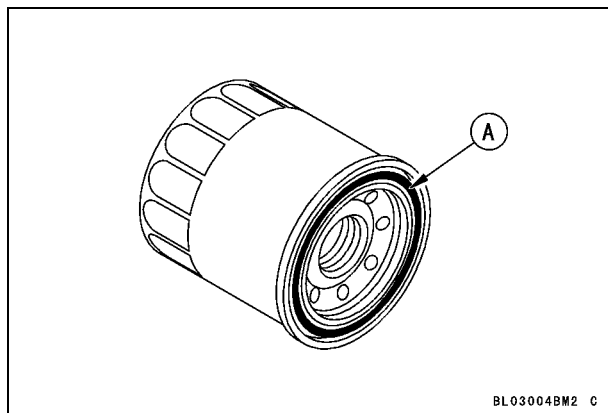

A. Packing

- Install the drain plug with its gasket. Tighten it to the specified torque.

Tightening Torque

Drain Plug: 22 N·m (2.2 kgf·m, 16.0 ft·lb)

NOTE

- *Replace any damaged gaskets with new ones.*
- Fill the engine up to the “F” (Full) line on the dipstick with good quality engine oil as specified in the table.
- Start the engine and check for oil leakage.

Engine Oil

Type:	Kawasaki Performance 4-Stroke ATV/UTV Oil* Kawasaki Performance 4-Stroke Semi-Synthetic Oil* Kawasaki Performance 4-Stroke Full Synthetic Oil* or other 4-stroke oils with API SG, SH, SJ, SL, SM and JASO MA, MA1, MA2 rating
Viscosity:	SAE 10W-40
Capacity:	1.3 L (1.4 US qt) [when filter is not removed] 1.5 L (1.6 US qt) [when filter is removed]

*Kawasaki Performance Oils and Lubricants have been specifically engineered for your vehicle. Consistent use of these products meets or exceeds warranty and service requirements and can help to extend the life of your Kawasaki.

NOTE

- *Do not add any chemical additive to the oil. Oils fulfilling the above requirements are fully formulated and provide adequate lubrication for the engine.*

Although 10W-40 engine oil is the recommended oil for most conditions, the oil viscosity may need to be changed to accommodate atmospheric conditions in your riding area.

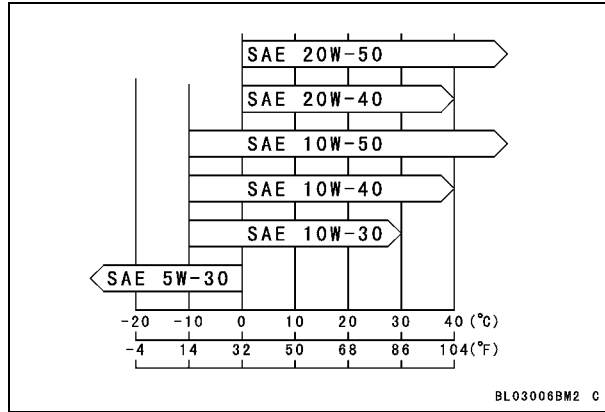

Front Final Gear Case Oil (KAF620M)

In order for the differential, pinion, and ring gears to function properly, check the oil level and change the oil in accordance with the Periodic Maintenance Chart.

⚠ WARNING

Vehicle operation with insufficient, deteriorated, or contaminated oil causes accelerated wear of the differential, pinion, and ring gears and may result in seizure. Seizure can lock the front and rear wheels and skid the front and rear tires, with consequent loss of control, accident, and injury. Check the oil level and change the oil according to the owner's manual.

Oil Level Inspection

- Remove the front final gear case guard by removing the mounting bolts and nuts.

84 MAINTENANCE AND ADJUSTMENT

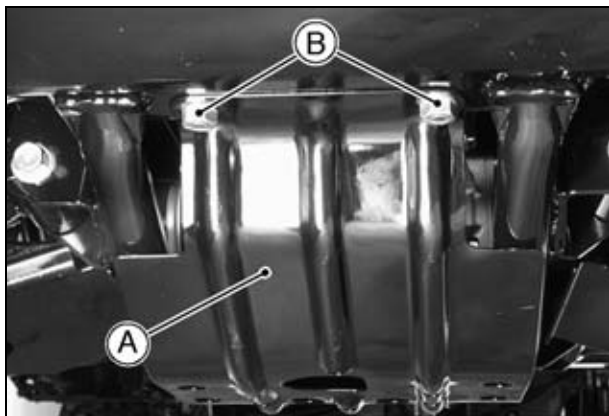

A. Guard
B. Nuts (Front Side)

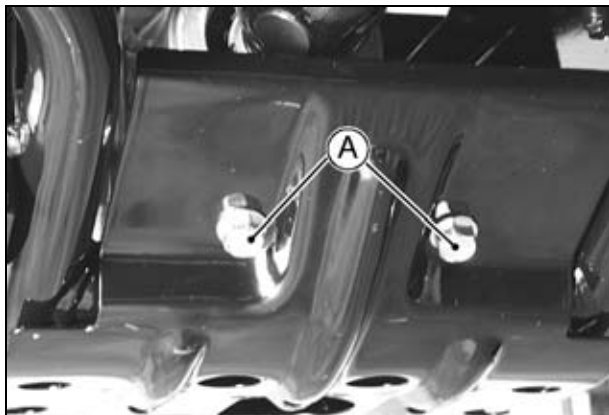

A. Bolts (Rear Side)

- With the vehicle level front-to-rear and side-to-side, remove the filler cap from the front final gear case.

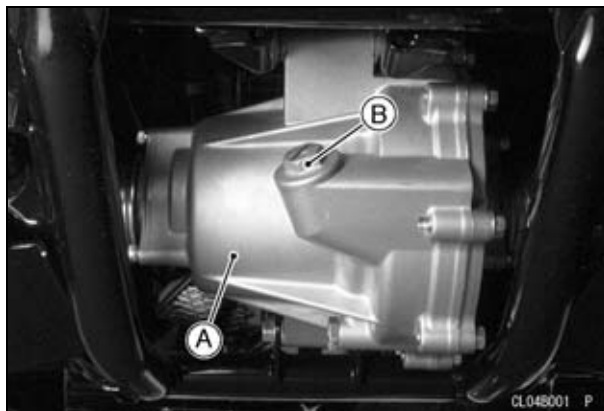

A. Front Final Gear Case
B. Filler Cap

NOTICE

Be careful not to allow any dirt or foreign materials to enter the gear case.

- Check the oil level. The oil level should come to the bottom thread of the filler opening. If it is low, add oil through the oil filler opening as necessary.

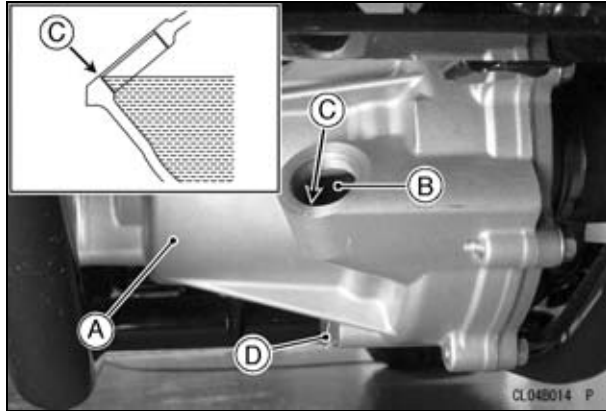

- A. Front Final Gear Case
- B. Filler Opening
- C. Bottom Thread
- D. Drain Plug

- Install the filler cap and tighten it to the specified torque.

Tightening Torque

Filler Cap: 29 N·m (3.0kgf·m, 21 ft·lb)

NOTE

- Use the same type and brand of oil that is already in the gear case.

Oil Change

NOTE

- Before draining the oil, warm it up by running the vehicle. Warm oil drains easily and picks up any sediment.

- Remove the front final gear case guard.
- With the vehicle level, place an oil pan beneath the gear case.
- Remove the filler cap and drain plug.

⚠ WARNING

Gear case oil is a toxic substance. Dispose of used oil properly. Contact your local authorities for approved disposal methods or possible recycling.

⚠ WARNING

Oil on tires can make them slippery which can cause an accident and injury. When draining or filling the gear case, be careful that no oil gets on the tires or rims. Clean off any oil that inadvertently gets on them with soap and water.

- After the oil has completely drained out, install the drain plug and gasket. If the gasket is damaged, replace it with a new one.

Tightening Torque

Drain Plug: 20 N·m (2.0 kgf·m, 15 ft·lb)

86 MAINTENANCE AND ADJUSTMENT

- Fill the gear case up to the bottom thread of the filler opening with a good quality oil as specified in the table.

Front Final Gear Case Oil

Oil Capacity	0.4 L (0.4 US qt)
Oil Type	API GL-5 SAE140 or API GL-6 SAE90 Hypoid gear oil for Limited Slip Differentials

- Install the filler cap and gear case guard.

Transmission Case Oil

In order for the transmission, differential, pinion, and ring gears to function properly, check the oil level and change the oil in accordance with the Periodic Maintenance Chart.

WARNING

Vehicle operation with insufficient, deteriorated, or contaminated oil causes accelerated wear of the transmission, differential, pinion, and ring gears and may result in seizure. Seizure can lock the rear wheels and skid the rear tires, with consequent loss of control, accident, and injury. Check the oil level and change the oil according to the owner's manual.

Oil Level Inspection

- Park the vehicle on level ground.
- Lift the cargo bed and support it with the rod.
- Unscrew the oil filler plug, wipe its dipstick dry, and insert it into the filler hole but DO NOT SCREW IT IN.

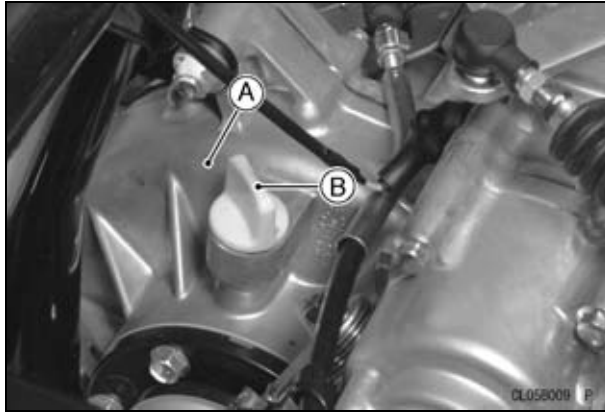

A. Transmission Case
B. Oil Filler Plug

NOTICE

Be careful not to allow any dirt or foreign materials to enter the transmission case.

- Pull out the dipstick and check the oil level. The oil level should be between the “H” (High) and “L” (Low) lines on the dipstick.

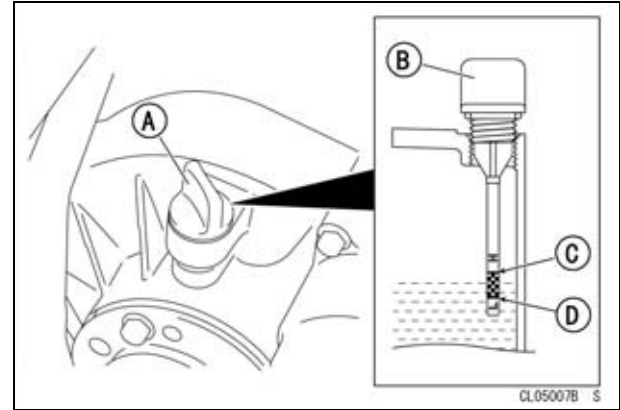

- A. Oil Filler Plug and Dipstick**
- B. Insert the dipstick into the filler hole but do not screw it in.**
- C. “H” (High) Line**
- D. “L” (Low) Line**

- If the oil level is too high, remove the excess oil, using a syringe or other suitable device, through the oil filler opening.
- If the oil level is too low, add the correct amount of oil.
- Install the filler plug.

NOTE

- Use the same type and brand of oil that is already in the transmission case.

88 MAINTENANCE AND ADJUSTMENT

Oil Change

NOTE

- *Before draining the oil, warm it up by running the vehicle. Warm oil drains easily and picks up any sediment.*
- With the vehicle level, place an oil pan beneath the transmission case.
- Remove the drain plug.

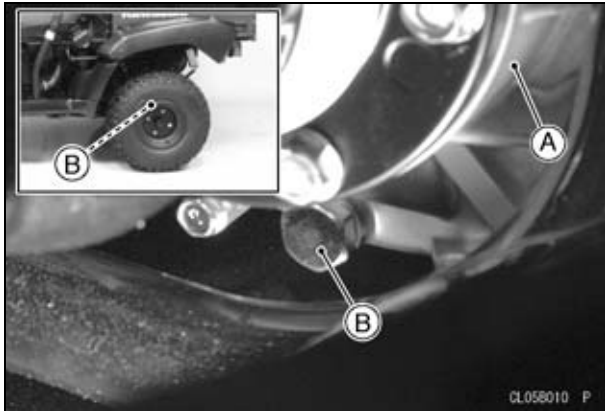

- A. Transmission Case**
- B. Drain Plug**

⚠ WARNING

The exhaust system can get extremely hot during normal operation and cause serious burns. To avoid a serious burn, never touch a hot muffler or exhaust pipe during oil draining.

- Lift the cargo bed and support it with the rod.
- Remove the filler plug.

⚠ WARNING

Oil on tires can make them slippery which can cause an accident and injury. When draining or filling the transmission case, be careful that no oil gets on the tires or rims. Clean off any oil that inadvertently gets on them with soap and water. Transmission case oil is a toxic substance. Dispose of used oil properly. Contact your local authorities for approved disposal methods or possible recycling.

- After the oil has completely drained out, install the drain plug with its gasket. Tighten it to the specified torque. If the gasket is damaged, replace it with a new one.
- Fill the transmission case up to the “H” (High) line on the dipstick with a good quality oil as specified in the table.

Tightening Torque

Drain Plug: 15 N·m (1.5 kgf·m, 11 ft·lb)

Transmission Case Oil Type

API “GL-5” Hypoid gear oil
 above 5°C (41°F) SAE 90
 below 5°C (41°F) SAE 80

Transmission Case Oil Capacity

KAF620M: 2.5 L (2.6 US qt)
 KAF620P: 2.2 L (2.3 US qt)

- Install the filler plug.

Cooling System

 WARNING

The cooling system can get extremely hot during normal operation and cause serious burns. Do not touch the radiator when it is hot, nor open the radiator cap. Hot coolant inside will cause severe burns.

Radiator and Cooling Fan

Check and clean the screen and radiator fins for obstruction by insects or mud in accordance with the Periodic Maintenance Chart. In dusty areas, the radiator should be cleaned more frequently than the recommended interval.

 WARNING

To avoid injury, keep your hands and clothing away from the fan blades at all times.

90 MAINTENANCE AND ADJUSTMENT



- A. Screen
- B. Radiator

- Clean the screen, and radiator fins of any obstructions with a stream of low-pressure water.
- If insects or mud can not be completely removed, it should be cleaned by an authorized Kawasaki dealer.

NOTICE

Using high-pressure water, as from a car wash facility, could damage the radiator fins and impair the radiator's effectiveness. Do not obstruct or deflect airflow through the radiator by installing unauthorized accessories in front of the radiator or behind the cooling fan. Interference with the radiator airflow can lead to overheating and consequent engine damage.

Coolant

Coolant absorbs excessive heat from the engine and transfers it to the air at the radiator. If the coolant level becomes low, the engine overheats and may suffer damage. Check the coolant level each day before operating the vehicle, and replenish coolant if the level is low. Change the coolant in accordance with the Periodic Maintenance Chart.

NOTE

- A permanent type of antifreeze is installed in the cooling system when shipped. It is colored green and contains ethylene glycol. It is mixed at 50% with water and has a freezing point of -35°C (-31°F).

Coolant Level Inspection

- Situate the vehicle on level ground.
- Lift the front cargo hood up. Refer to the "Front Cargo Compartment" section in the "General Information" chapter.
- Check the coolant level through the coolant level gauge on the reserve tank. The coolant level should be between the "F" (Full) and "L" (Low) marks.

NOTE

- Check the level when the engine is cold (room or atmospheric temperature).

Coolant Capacity

4.3 L (4.5 US qt)

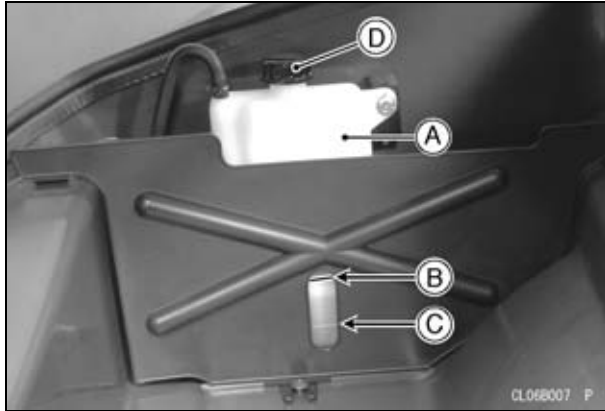

- A. Reserve Tank
- B. "F" (Full) Mark
- C. "L" (Low) Mark
- D. Cap

- If the amount of coolant is insufficient, unscrew the cap from the reserve tank and add coolant through the filler opening to the "F" (Full) mark. Install the cap.

Recommended Coolant Solution

Coolant Mixture Ratio:

Water 50%: Antifreeze 50% (1 : 1)

Recommended Antifreeze:

Permanent type antifreeze (ethylene glycol plus corrosion and rust inhibitor chemicals for aluminum engines and radiator).

NOTE

- In an emergency you can add water alone to the coolant reserve tank, however it must be returned to the correct mixture ratio by the addition of antifreeze concentrate as soon as possible.

NOTICE

If coolant must be added often, or the reserve tank completely runs dry, there is probably leakage in the system. Have the cooling system inspected by your authorized Kawasaki dealer.

Coolant Change

Have the coolant changed by an authorized Kawasaki dealer.

92 MAINTENANCE AND ADJUSTMENT

Spark Plugs

The standard spark plug is shown in the table. The spark plug should be taken out periodically in accordance with the Periodic Maintenance Chart for cleaning, inspection, and resetting of the plug gap.

Maintenance

If the plugs are oily or have carbon built up on them, clean them. The plugs may also be cleaned using a high flash-point solvent and a nonmetal brush (nylon etc.). Measure the gap with a wire-type thickness gauge, and adjust the gap if incorrect by bending the outer electrode. If the insulator is cracked, replace the plug. Use the standard plug.

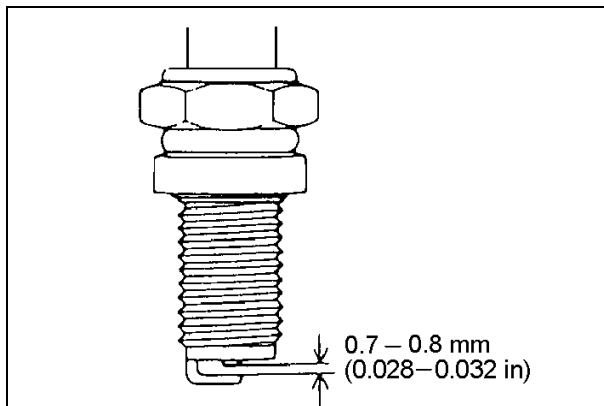

Spark Plug

Standard Plug	NGK BPR2ES
Plug Gap	0.7 ~ 0.8 mm (0.028 ~ 0.032 in.)
Tightening Torque	17 N·m (1.7 kgf·m, 13 ft·lb)

Spark Plug Removal

- Lift the cargo bed to support it with the rod.
- Carefully pull the spark plug caps from the spark plugs.

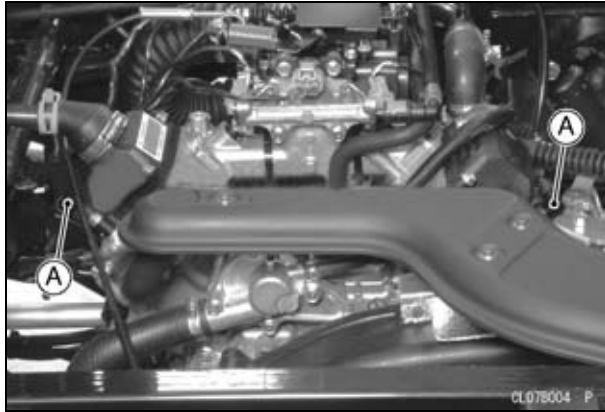

A. Spark Plug Caps

- Unscrew the spark plugs.

NOTE

- *Fit the plug cap securely onto the spark plug, and pull the cap tightly to make sure that it is properly installed.*

Valve Clearance

Valve and valve seat wear decrease valve clearance, upsetting valve timing.

NOTICE

If valve clearance is left unadjusted, wear will eventually cause the valves to remain partly open; which lowers performance, burns the valves and valve seats, and may cause serious engine damage.

Valve clearance for each valve should be checked and adjusted in accordance with the Periodic Maintenance Chart.

Inspection and adjustment should be done by an authorized Kawasaki dealer.

Valve Clearance (EX & IN): 0.25 mm (0.010 in.)

Engine Air Cleaner

A clogged engine air cleaner restricts the engine's air intake, increasing fuel consumption, reducing engine power, and causing spark plug fouling.

⚠ WARNING

A clogged air cleaner may allow dirt and dust to enter the fuel injection system and the throttle may stick resulting in a hazardous operating condition. Clean the air filter according to the periodic maintenance chart; more often if the vehicle is used in extremely dusty conditions.

NOTICE

A clogged air cleaner may allow dirt and dust to enter the engine causing excessive wear and possible engine damage.

The air filter element should be cleaned in accordance with the Periodic Maintenance Chart. In dusty areas, the elements should be cleaned more frequently than the recommended interval.

The engine air filter restriction gauge show whether the air cleaner is clogged. Whenever the red band shows in the gauge window, the air filter element should be cleaned. After servicing the air filter element, the restriction gauge should be reset by pushing the button at the end of the gauge.

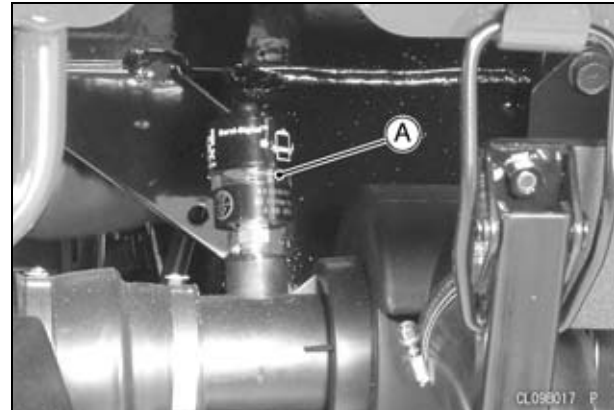

A. Air Filter Restriction Gauge

Element Removal

- Pull up the snaps and remove the air cleaner housing cap from the housing.

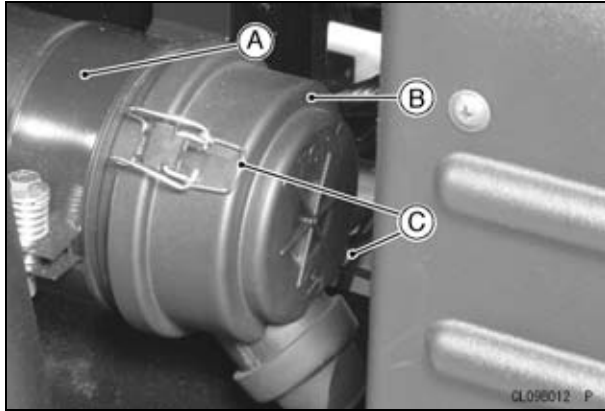

- A. Air Cleaner Housing
- B. Cap
- C. Snaps

- Pull the air cleaner element out of the housing.
- Push a clean, lint-free towel into the air cleaner housing to keep dirt or other foreign material from entering.

⚠ WARNING

If dirt or dust is allowed to pass through into the fuel injection system, the throttle may stick or become inoperable resulting in a hazardous operating condition.

NOTICE

If dirt gets into the engine, excessive engine and possible engine damage may occur.

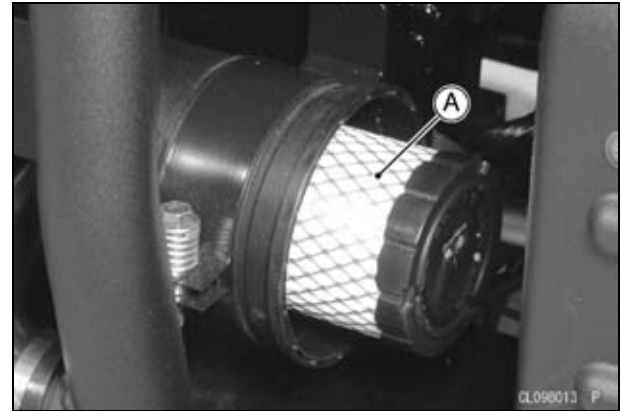

- A. Paper Element

NOTE

- *Element installation is performed in the reverse order of removal.*
- *Install the cap with its drain facing downward.*

96 MAINTENANCE AND ADJUSTMENT

Element Cleaning

- Remove the element (see Element Removal).
- Clean the paper element by tapping it lightly to loosen dust.
- Blow away the remaining dust by applying compressed air from the inside to the outside (from the clean side to the dirty side).
- Inspect the element material for damage. If any part of the element is damaged, the element must be replaced.
- Reset the air filter restriction gauge (push its button).

Dust and/or Water Inspection

- Push open the drain hose on the bottom of the air cleaner housing to expel dust and/or water accumulated inside.

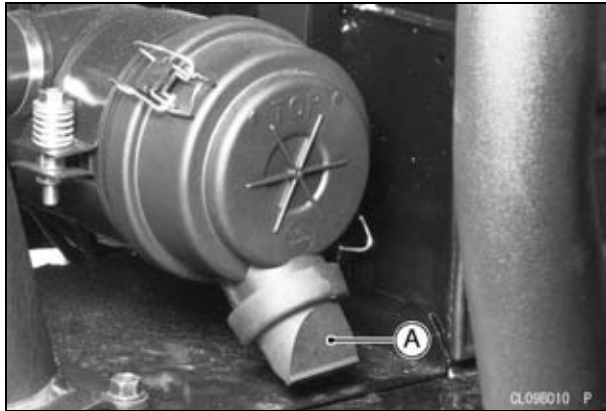

A. Drain Hose

Evaporative Emission Control System

This system routes fuel vapors from the fuel system into the running engine or stores the vapors in a canister when the engine is stopped. Although no adjustments are required, a thorough visual inspection must be made at the intervals specified by the "Periodic Maintenance Chart".

Inspection

- Check that the hoses are securely connected.
- Replace any kinked, deteriorated, or damaged hoses.

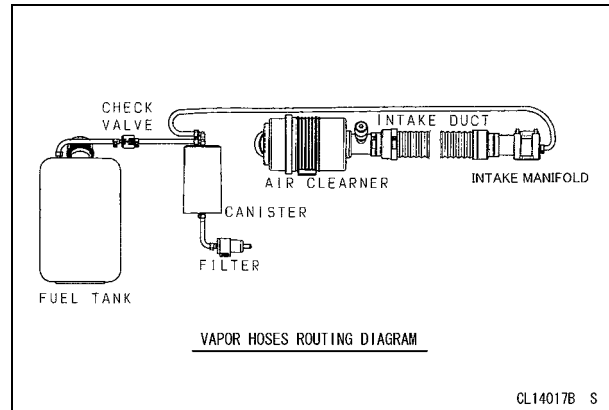

CL14017B S

Spark Arrester

This vehicle is equipped with a spark arrester approved for off-highway use by the U.S. Forest Service. It must be properly maintained to ensure its efficiency. Clean the spark arrester in accordance with the Periodic Maintenance Chart.

NOTICE

The spark arrester must be functioning properly to provide adequate fire protection.

Spark Arrester Cleaning

⚠ WARNING

The muffler can become extremely hot during normal operation and cause severe burns.

Since the engine must be running during this procedure, wear heat-resistant gloves while cleaning the spark arrester.

- Remove the drain plug from the muffler.

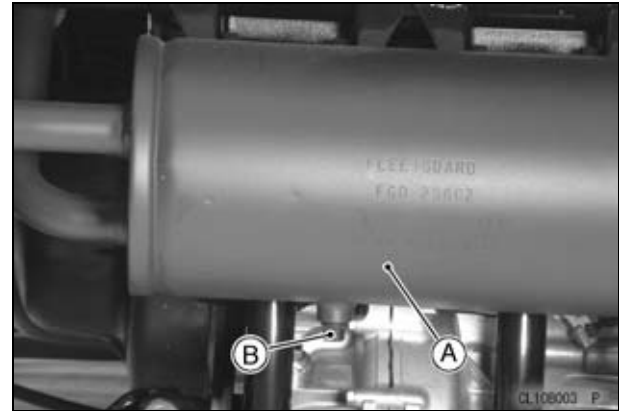

- A. Spark Arrester (inside the muffler)
- B. Drain Plug

- Apply the parking brake.
- In an open area away from combustible materials, start the engine with the gear shift lever in the "N" (Neutral) position.
- Raise and lower engine speed while tapping on the muffler with a rubber mallet until carbon particles are purged from the muffler.

DANGER

Exhaust gas contains carbon monoxide, a colorless, odorless poisonous gas. Inhaling carbon monoxide can cause serious brain injury or death. Do not run the engine in enclosed areas. Operate only in a well-ventilated area.

- Stop the engine.
- Install the drain plug.

Throttle Pedal

If the throttle pedal has excessive play due to either cable stretch or misadjustment, it will cause a delay in throttle response, especially at low engine speed. Also, the throttle may not open fully. If the throttle pedal has no play, the throttle may be hard to control, and the idle speed may be erratic. Check the throttle pedal play periodically in accordance with the Periodic Maintenance Chart, and adjust the play if necessary.

Throttle Pedal Play Inspection

- Apply the parking brake.
- Put the gear shift lever in the “N” (Neutral) position.
- Start the engine, and warm it up thoroughly.
- Measure the distance the throttle pedal moves before the engine begins to pick up speed. Free play should be 5 ~ 10 mm (0.2 ~ 0.4 in.).
- Stop the engine and check that the throttle pedal moves smoothly from full open to close, and the throttle closes quickly and completely.
- If the throttle pedal does not return properly, check the throttle cable routing, pedal free play, and cable damage. Then lubricate the throttle cable.

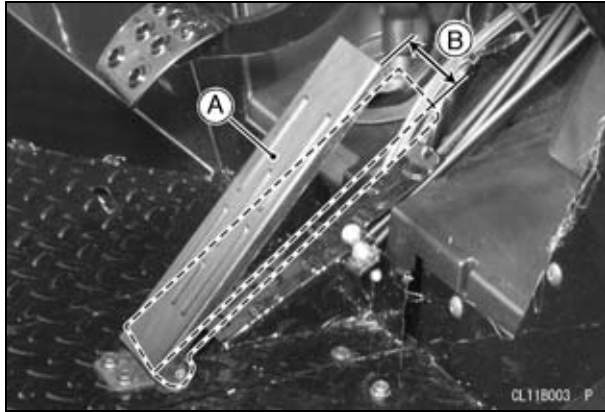

A. Throttle Pedal
B. 5 ~ 10 mm (0.2 ~ 0.4 in.)

Throttle Pedal Play Adjustment

- Lift the cargo bed and support it with the rod.
- Loosen and turn the throttle cable mounting nuts at the end of the throttle cable.
- Slide the adjuster until the proper amount of throttle pedal play is obtained.

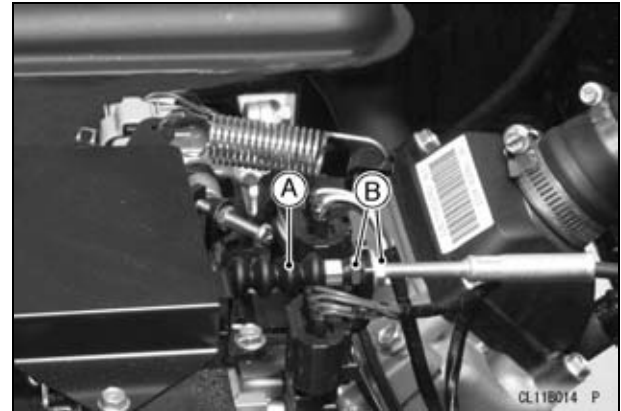

A. Throttle Cable
B. Mounting Nuts

- Tighten the mounting nuts securely.

100 MAINTENANCE AND ADJUSTMENT

Throttle Pedal Stop Position Adjustment

The full throttle pedal stop position can be adjusted to prevent pulling the throttle cable more than required.

- Remove the cover by unscrewing the bolt.

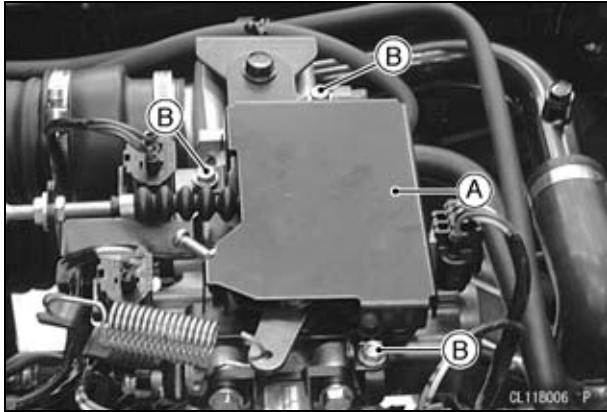

A. Cover
B. Bolt

- Loosen the locknut.
- Screw in the throttle pedal stop bolt.
- Depress the throttle pedal until the pulley on the main throttle valve touches to the stopper at the fully opened position and hold it there.

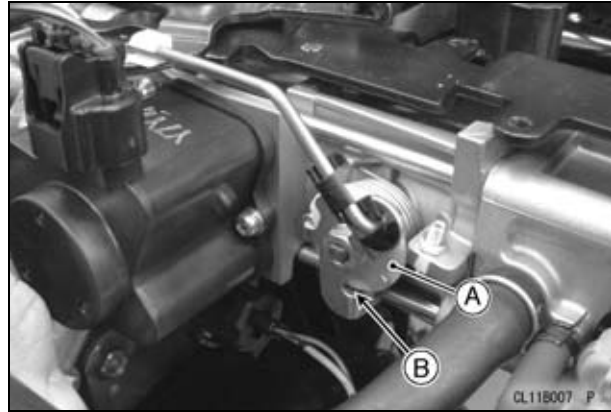

A. Pulley (Fully Opened Position)
B. Stopper

- Turn the throttle pedal stop bolt until the bolt head lightly touches the bottom of the throttle pedal.
- Tighten the locknut securely.
- Be sure to check the throttle cable moves smoothly.

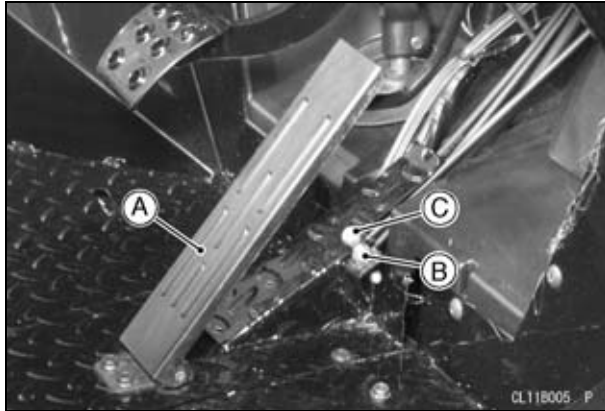

- A. Throttle Pedal**
- B. Locknut**
- C. Throttle Pedal Stop Bolt**

Idle Adjustment

Idle adjustment is controlled by the ECU and cannot be adjusted. If the idle speed is unstable, have your dealer inspect the throttle body.

Specified Idle Speed:	950 \pm 50 rpm
-----------------------	------------------

High Altitude Use

High altitude adjustment is not required as the ECU (electronic control unit) controls the air/fuel mixture automatically.

102 MAINTENANCE AND ADJUSTMENT

Fuel Pump Filter

The fuel pump filter can become blocked causing fuel pump damage if dirt/mud/debris or contaminated fuel enters the fuel tank. The engine may hesitate or lose power if the fuel pump filter becomes blocked. If you suspect that the fuel filter has become blocked, have your authorized Kawasaki dealer inspect the fuel pump and fuel tank.

Fuel Tank Vent

The fuel tank vent hoses must be routed as specified.

The engine may stall or lose power if the fuel tank vent is plugged or if the vent hoses are pinched. Inspect the vent hoses before riding and whenever the engine seems to lose power. If the fuel tank is full but the engine feels as if it is running out of fuel, check the vent and vent hoses.

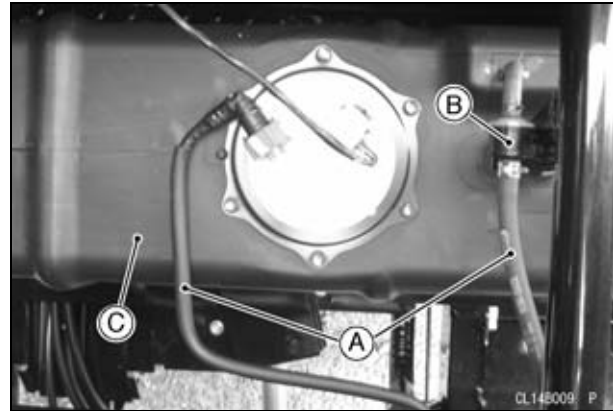

- A. Fuel Tank Vent Hoses
- B. Check Valve
- C. Fuel Tank

Belt Drive Torque Converter

The vehicle is equipped with a belt drive torque converter type automatic transmission. The belt, driven pulley shoes and drain hose should be checked in accordance with the Periodic Maintenance Chart.

The belt and driven pulley shoes inspection should be done by an authorized Kawasaki dealer.

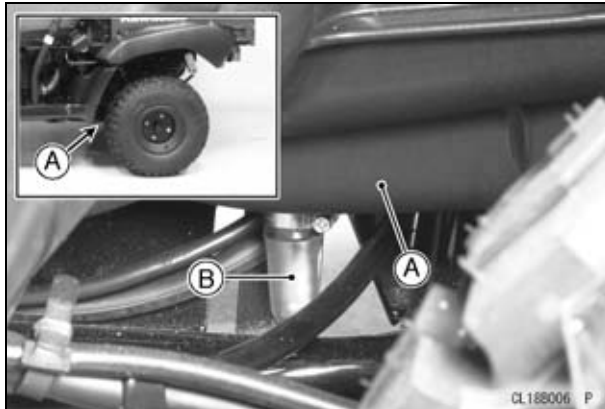

A. Belt Drive Torque Converter (inside)
B. Drain Hose

Dust and/or Water Inspection

- Unscrew the clamp screw and remove the drain hose on the bottom of the converter housing to expel dust and/or water accumulated inside.

Belt Drive Torque Converter Air Cleaner

A clogged belt drive torque converter air cleaner may cause the torque converter to malfunction.

NOTICE

A clogged air cleaner may allow dirt and dust to enter the belt drive torque converter causing excessive wear of the inner parts and loss of driving power.

The air cleaner elements must be cleaned in accordance with the Periodic Maintenance Chart. In dusty areas, the elements should be cleaned more frequently than the recommended interval. The elements should be replaced if they are damaged.

Element Removal

- For the belt drive torque converter air cleaner, release the snaps and remove the air cleaner housing cover from the housing.
- Pull the air cleaner element out of the housing.
- Push a clean, lint-free towel into the air cleaner housing to keep dirt or other foreign material from entering.

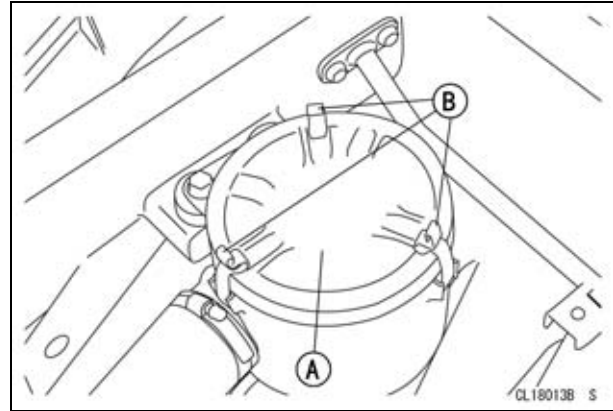

A. Air Cleaner Housing Cover
B. Snaps

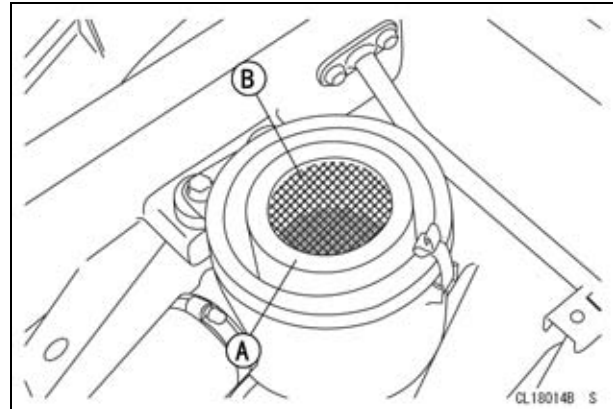

A. Urethane Foam Element
B. Holder

NOTICE

If dirt gets into the belt drive torque converter, excessive wear and loss of driving power may result.

NOTE

- *Element installation is performed in the reverse order of removal.*

Element Cleaning

- Remove the element (see Element Removal).
- Remove the urethane foam element from the holder.
- Clean the foam element in a bath of high flash-point solvent using a soft bristle brush.
- Squeeze it dry in a clean towel. Do not wring the element or blow it dry; the element can be damaged.
- Inspect the foam element for damage. If it is torn, punctured, or hardened, replace it.

NOTE

- *Replace the foam element after cleaning it five times or if it is damaged.*
- Clean the holder by tapping it lightly to loosen dust.
- Blow away the remaining dust by applying compressed air from the inside to the outside (from the clean side to the dirty side).

- Inspect the element material for damage. If any part of the element is damaged, the element must be replaced.

Brakes

The vehicle is equipped with hydraulically activated drum brakes on all four wheels.

Brake Pedal

Brake Pedal Free Play Inspection

In accordance with the Periodic Maintenance Chart, check the brake pedal free play.

- Depress the brake pedal lightly by hand.
- There should be 2 ~ 10 mm (0.1 ~ 0.4 in.) of free play.

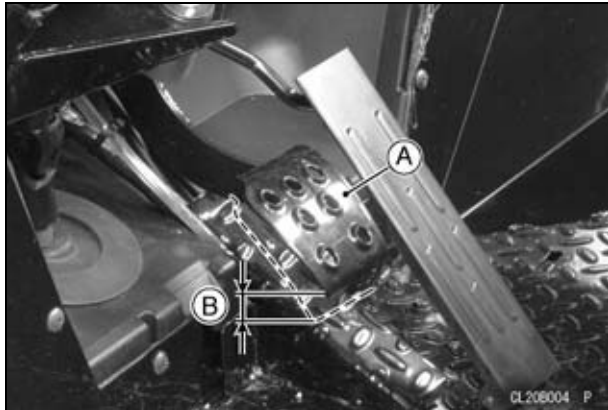

- A. Brake Pedal
- B. 2 ~ 10 mm (0.1 ~ 0.4 in.)

- If the brake pedal has more or less free play than specified or the pedal action feels rough or

“catchy,” have the brake system inspected immediately by an authorized Kawasaki dealer.

Brake Shoe Linings

Brake Shoe Lining Wear Inspection

In accordance with the Periodic Maintenance Chart have the brake shoe linings checked for wear by an authorized Kawasaki dealer.

Brake Fluid

In accordance with the Periodic Maintenance Chart, inspect the brake fluid level in the reservoir and change the brake fluid. The brake fluid should also be changed if it becomes contaminated with dirt or water.

Fluid Requirement

Use heavy-duty brake fluid only from a fresh, unopened container marked DOT3.

⚠ WARNING

Over time, brake fluid can absorb moisture, lowering its boiling point and reducing brake effectiveness. Do not use fluid from a container that has been left unsealed or that has been open for a long time. Do not mix two types and brands of fluid for use in the brakes. Don't leave the reservoir cap off for any length of time to avoid moisture contamination of the fluid. Don't add or change brake fluid in the rain or during conditions of blowing dust or debris.

NOTICE

Brake fluid quickly ruins painted surfaces. Wipe up any spilled fluid immediately.

Fluid Level Inspection

- With the vehicle on level ground, check that, through the inspection hole in the dashboard, the fluid level in the reservoir is between the upper (marked MAX) and lower (marked MIN) level lines.



A. Inspection Hole

- If the fluid level is lower than the lower level line, check for fluid leaks in the brake lines, and open the front cargo hood (see “Front Cargo Compartment” section in the “General Information” chapter) and fill the reservoir to the upper level line.
- Remove the rubber cover.

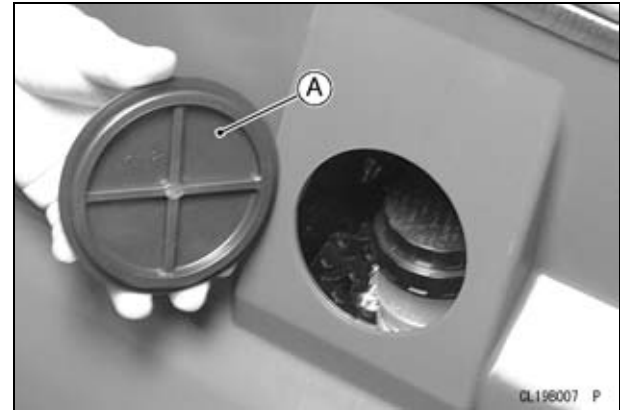

A. Cap

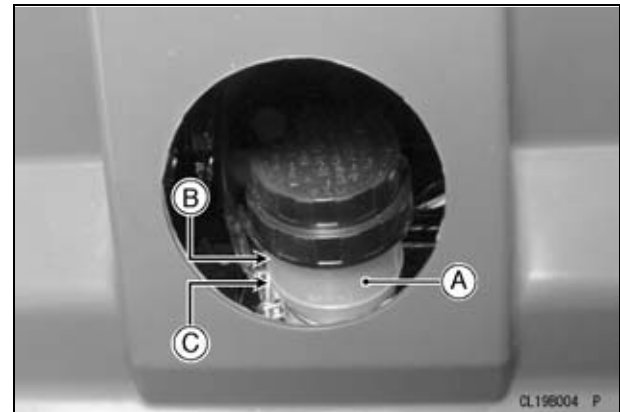

**A. Brake Fluid Reservoir
B. Upper Level Line (MAX)
C. Lower Level Line (MIN)**

⚠ WARNING

Mixing two types and brands of fluid for use in the brake lowers the brake fluid boiling point and could reduce brake effectiveness. Change the fluid in the brake system completely if the fluid level is low but the type and brand of the fluid already in the reservoir are unknown.

- Apply the brake forcefully for a few seconds and check for fluid leakage around the fittings.

⚠ WARNING

Air in brake line can make the brake feel mushy or soft. This may cause reduced braking performance or brake failure and result in an accident. If brake lever travel is excessive or the brake feels mushy, have an authorized Kawasaki dealer inspect it immediately.

Fluid Change

Have the brake fluid changed by an authorized Kawasaki dealer.

Brake Light Switch

When the brake pedal is depressed, the brake light goes on. The brake light switch should be inspected in accordance with the Periodic Maintenance Chart.

Inspection

- Turn the ignition switch to the “ON” position.
- Depress the brake pedal. The brake light should go on after about 10 mm (0.4 in.) of pedal travel.

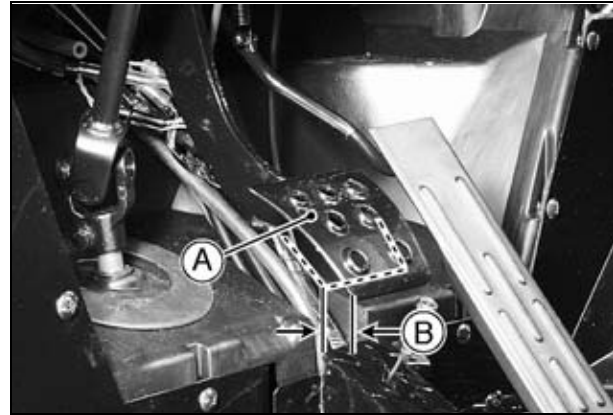

- A. Brake Pedal
- B. 10 mm (0.4 in.)

- If it does not, check the bulb and, if necessary, adjust the brake light switch.

Adjustment

- Adjustment is best performed by an authorized Kawasaki dealer since the brake light switch is hard to adjust.

NOTICE

To avoid damaging the electrical connections inside the switch, be sure that the switch body does not turn during adjustment.

Parking Brake Lever

The parking brake helps hold the vehicle from rolling while parked.

In accordance with the Periodic Maintenance Chart, check that the parking brake lever functions properly.

Inspection

- Pull the rubber boot up on the bottom.

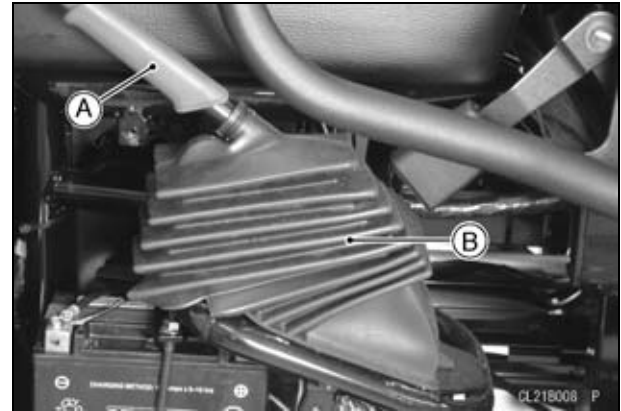

A. Parking Brake Lever

B. Rubber Boot

110 MAINTENANCE AND ADJUSTMENT

- Pull the parking brake lever up and to the rear.
- After 8 to 12 clicks of lever travel, the vehicle should not roll while parked.



A. 8 ~ 12 clicks

- If it does, adjust the parking brake lever.

Adjustment

- Loosen the locknut (upper nut) on the middle of the parking brake lever, and turn the nut next to the locknut until the brake lever will only move 8 ~ 12 clicks upward.

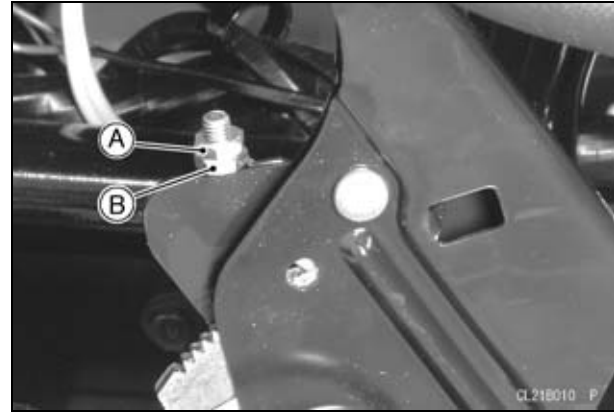

A. Locknut

B. Nut

- Tighten the locknut securely.
- Reinstall the rubber boot making sure that the projections on its lower edge are completely pushed into the holes in the bracket.

NOTE

- *Be sure to hold the cable end with a wrench to prevent the cable from twisting.*
- *If the brake lever can not be adjusted with the nuts shown here, or if there is any doubt as to the condition or braking effectiveness, have the parking brake system inspected by an authorized Kawasaki dealer.*

Steering Wheel

In accordance with the Periodic Maintenance Chart, check the steering wheel for the specified free play and smooth operation.

Free Play Inspection

- Park the vehicle on level ground.
- Lightly turn the steering wheel left and right.
- There should be 0 ~ 20 mm (0 ~ 0.8 in.) of free play.
- If there is excessive free play or strange noises, or the steering feels rough or “catchy,” have the steering system checked by an authorized Kawasaki dealer.

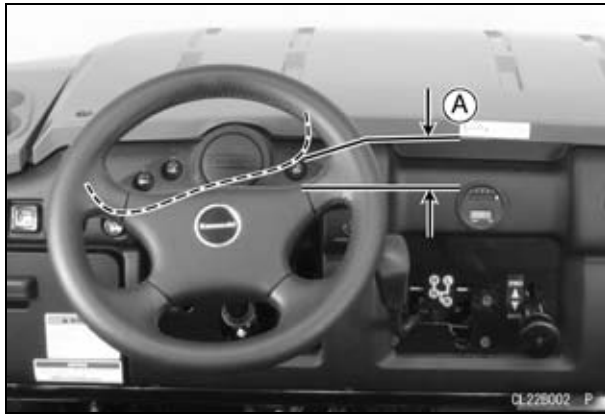

A. 0 ~ 20 mm (0 ~ 0.8 in.)

Steering Position Adjustment

The steering wheel position can be adjusted to suit the operator.

- Loosen the upper and lower nuts on the steering column bracket and move the steering wheel up or down.

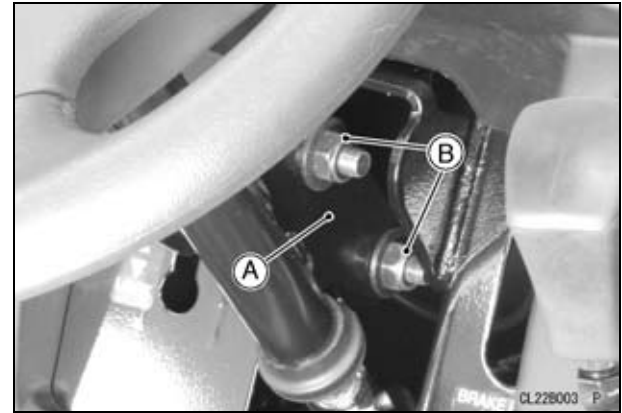

A. Steering Column Bracket
B. Nuts

- Tighten the bolts and nuts.

112 MAINTENANCE AND ADJUSTMENT

Power Steering System (KAF620M)

Steering may become more difficult than usual for the following reasons:

- The steering wheel was continuously turned or held to the full turn stops with torque applied by driver. In this case the ECU works to protect the system from overheating by stopping the power assisting. Stop turning the steering wheel and wait until the system temperature drops, and the power steering recovers.
- Fuses in the harness may have blown. There are several reasons that the fuses may blow. Refer to the Fuse section in this chapter for details.
- Battery voltage has dropped. Voltage drop can happen when the engine starts; inspect the battery voltage.
- Cable harness or connectors may have been disconnected. See an authorized dealer for service.

NOTE

○ If the steering becomes irregular or unusual for any reason other than above, have an authorized dealer check the steering and relevant components immediately. In some cases the power steering's neutral position can be affected by an accident or bump.

Wheels

Rims

The rims are a drop-center, tubeless tire design. Take care not to damage the sealing surfaces of the tire or rim when removing or installing tires. Note that the rims, like automotive rims, are not symmetrical. All wheels must be installed so that the valve stems are on the outside of the vehicle.

Wheel Nuts

Check for wheel nuts tightness in accordance with the Periodic Maintenance Chart.

Tightening Torque: 137 N·m (14 kgf·m, 101 ft·lb)
--

Tires

The front and rear tires are knobby tubeless tires. When replacing tires, check the valve stems and cores for damage. Take care not to damage the tire sealing surfaces of the rims.

Standard Tires (front and rear):

23 × 11.00-10 DUNLOP KT869

23 × 11.00-10 DURO DI-K968

Tire Air Pressure (when cold)

Front	69 kPa (0.7 kgf/cm ² , 10 psi)
Rear	167 kPa (1.7 kgf/cm ² , 24 psi)

NOTE

- *Tires are an important part of the suspension of the vehicle. Tire construction characteristics and tire inflation pressure can greatly influence vehicle handling. Kawasaki recommends that you always replace tires with standard replacement tires as shown above. It is also very important to have tires of the same type and size on all axles, and at the same inflation pressure, on each axle.*
- *Installation of non-standard tires, or use of different tires on one axle, can change or impair the handling of the vehicle.*
- *Installation of tubeless tires on rims requires compressed air and is normally recommended as a dealer service operation. Nevertheless, a tube can be inserted into the tire by the operator as an emergency repair.*

Maximum Tire Air Pressure for Seating Beads

Front and Rear	250 kPa (2.5 kgf/cm ² , 36 psi)
----------------	--

Payload and Tire Pressure

Failure to maintain proper inflation pressures or observe payload limits for your tires can change or impair handling and performance of the vehicle. The maximum recommended load carrying capacity is 603 kg (1 330 lb).

Use a tire pressure gauge to accurately set tire pressure.

 WARNING
Operating with unequally or improperly pressurized tires can adversely affect steering or handling. Inflate both front tires to the same pressure and both rear tires to the same pressure.

114 MAINTENANCE AND ADJUSTMENT

Tire Wear, Damage

As tire tread wears down, tires become more susceptible to puncture and failure.

- In accordance with the Periodic Maintenance Chart, measure the depth of the tread with a depth gauge, and replace any tire that has worn down to the minimum allowable tread depth.



A. Tire Depth Gauge

Minimum Tread Depth: 3 mm (0.12 in.)

- Visually inspect the tire for cracks and cuts, replacing the tire in case of bad damage. Swelling or high spots indicate internal damage, requiring tire replacement.
- Remove any imbedded stones or other foreign particles from the tread.

Joint Boots

In accordance with the Periodic Maintenance Chart, inspect the joint boots on the front axles, tie rod ends, steering knuckles, and rear axle shafts for cracks, holes, damage or deterioration. If there is any one of them, have the joint boot replaced by an authorized Kawasaki dealer.

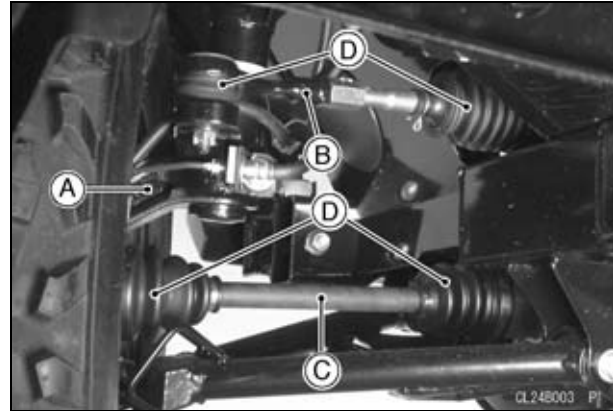

- A. Steering Knuckle**
B. Tie Rod
C. Front Axle
D. Joint Boots

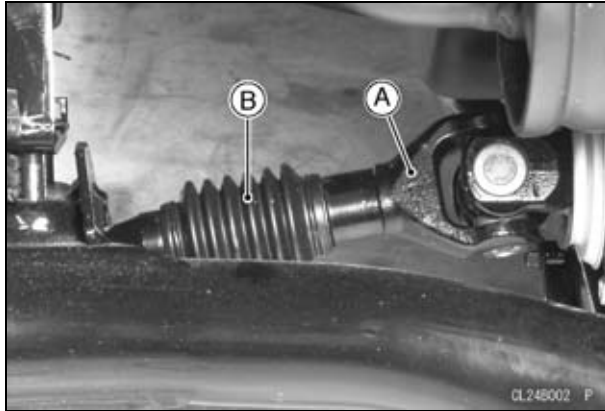

A. Rear Axle
B. Joint Boot

Seat Belts

In accordance with the Periodic Maintenance Chart, check that each seat belt functions properly. Push the latch plate into the buckle until it clicks. The latch plate must slide smoothly into the buckle. The click sound shows it is securely latched. Push the red button in the buckle to make sure it releases freely. Also check the belt webbing for wear, cuts or damage. If any irregularities are found, have the seat belt system checked or replaced by an authorized Kawasaki dealer.

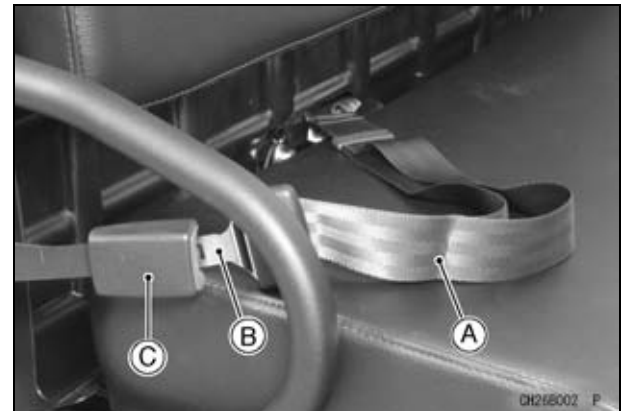

A. Latch Plate
B. Buckle
C. Red Button

116 MAINTENANCE AND ADJUSTMENT

Headlight Beam

The headlight beams can be adjusted vertically.

- Remove the holder.

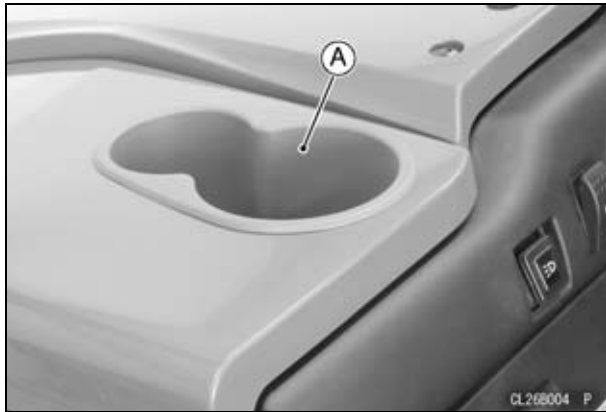

A. Holder

- Turn the adjusting screw on each headlight rim in or out to adjust the headlight vertically.

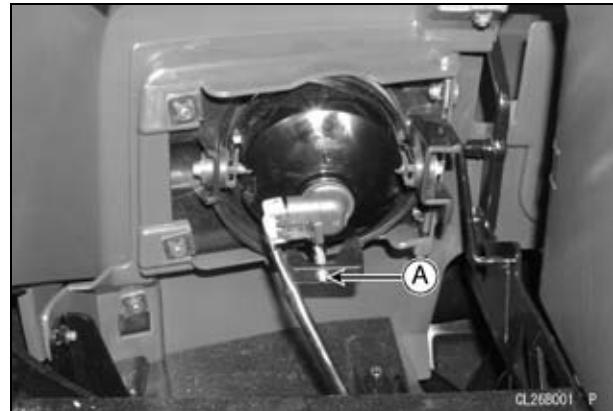

A. Adjusting Screws

Battery

The battery is located under the left end of the seat.

⚠ DANGER

Battery contains sulfuric acid and produces hydrogen gas. Sulfuric acid can cause burns and hydrogen gas can cause an explosion. Read and heed the battery safety label.

Battery Removal

- Remove the cover under the front seat left end.

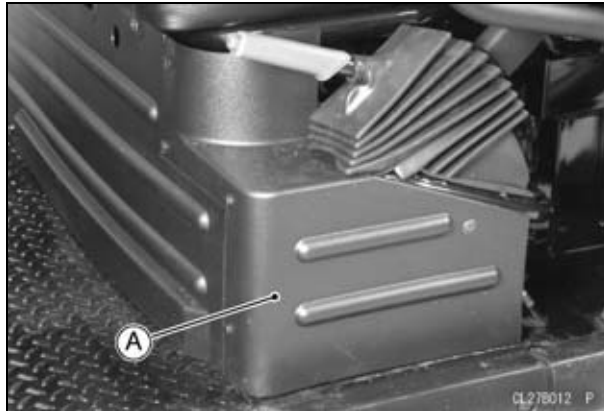

A. Cover

- Remove the battery holder.

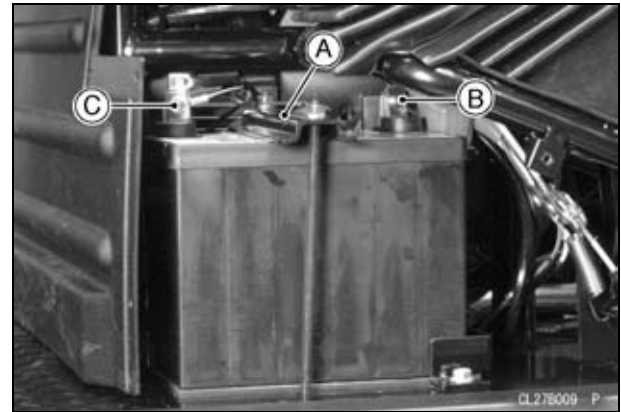

- A. Holder**
- B. (+) Terminal**
- C. (-) Terminal**

- Disconnect the cables from the battery, first from the (-) terminal and then the (+) terminal.

NOTE

- *There is no need to separate the smaller cables clamped with the main battery cables.*
- Take the battery out.
- Clean the battery using a solution of baking soda and water. Be sure that the lead connections are clean.
- Perform a visual inspection. Inspect for defective or cracked case and cover, and loose or damaged terminal posts or cables. Replace battery and/or cables immediately if any damage is found.

118 MAINTENANCE AND ADJUSTMENT

Battery Installation

- Check that the rubber dampers on the battery holder and the floor board are properly in place.
- Put the battery in place on the rubber damper.
- Connect the three positive cables to the (+) terminal, and then connect the negative cable to the (-) terminal.

NOTE

- *Be sure to reconnect any other cables.*
- Put a light coat of grease on the terminals to prevent corrosion.
- Reinstall the battery cover and holder.

WARNING

Loose battery cables can create sparks which can cause a fire or explosion resulting in injury or death.

Make sure the battery terminal screws are tightened securely and the covers are installed over the terminals.

NOTICE

Do not reverse the battery connections, or damage to the regulator/rectifier unit will result.

Battery Characteristics

The battery installed in this vehicle is a sealed type, and the sealing strip should not be removed at any time after the specified electrolyte has been

installed in the battery for initial service. It is not necessary to check the battery electrolyte level or add distilled water.

However, in order to maximize battery life and ensure that it will provide the power needed to start your vehicle you must properly maintain the battery's charge. When used regularly, the charging system in your vehicle helps keep the battery fully charged. If your vehicle is only used occasionally or for short periods of time, the battery is more likely to discharge.

Due to their internal composition, batteries continually self discharge. The discharge rate depends on the type of battery and ambient temperature. As temperatures rise, so does the discharge rate. Every 15°C (59°F) doubles the rate.

Electrical accessories, such as digital clocks and computer memory, also draw current from the battery even when the key is switched off. Combine such "key-off" draws with hot temperature, and a battery can go from fully charged to completely discharged in a matter of days.

Self-discharge		
Temperature	Approx. Number of Days From 100% Charged to 100% discharged	
	Lead-Antimony Battery	Lead-Calcium Battery
40°C (104°F)	100 Days	300 Days
25°C (77°F)	200 Days	600 Days
0°C (32°F)	550 Days	950 Days

Current Drain		
Discharging Ampere	Days from 100% Charged to 50% Discharged	Days from 100% Charged to 100% Discharged
7 mA	60 Days	119 Days
10 mA	42 Days	83 Days
15 mA	28 Days	56 Days
20 mA	21 Days	42 Days
30 mA	14 Days	28 Days

In extremely cold weather the fluid in an inadequately charged battery can easily freeze, which can crack the case and buckle the plates. A fully charged battery can withstand sub-freezing temperatures with no damage.

Battery Sulfation

A common cause of battery failure is sulfation. Sulfation occurs when the battery is left in a discharged condition for an extended time. Sulfate is a normal by product of the chemical reactions within a battery. But when continuous discharge allows the sulfate to crystallize in the cells, the battery plates become permanently damaged and will not hold a charge. Battery failure due to sulfation is not warrantable.

Battery Maintenance

It is the owner’s responsibility to keep the battery fully charged. Failure to do so can lead to battery failure and leave you stranded.

If you are riding your vehicle infrequently, inspect the battery voltage weekly using a voltmeter. If it drops below 12.6 volts, the battery should be charged using an appropriate charger (check with your kawasaki dealer or visit by kawasaki.com). If you will not be using your vehicle for longer than two weeks, the battery should be charged using an appropriate charger. Do not use an automotive-type quick charger that may overcharge the battery and damage it.

NOTE

○ *Leaving the battery connected causes the electrical components to make the battery discharged, resulting the over discharge of the battery. In this case, the repair or replacement of the battery is not included in the warranty. If you do not drive for four weeks or more, disconnect the battery from the vehicle.*

Kawasaki-recommended chargers are:

- Battery Mate 150-9
- OptiMate 4
- Yuasa MB-2040/2060
- Christie C10122S

If the above chargers are not available, use equivalent one.

For more details, ask your Kawasaki dealer.

120 MAINTENANCE AND ADJUSTMENT

Battery Charging

- Remove the battery from the vehicle (see Battery Removal).
- Attach the leads from the charger and charge the battery at a rate (amperage × hours) that is indicated on the battery. If it is not possible to read the rate, charge the battery at an amperage that is about 1/10th of the battery capacity.
- The charger will keep the battery fully charged until you are ready to reinstall the battery in the vehicle (see Battery Installation).

NOTICE

**Never remove the sealing strip, or the battery can be damaged.
Do not install a conventional battery in this vehicle, or the electrical system cannot work properly.**

Make	East Penn Manufacturing
Type	8U1L

NOTE

- *If you charge the sealed battery, never fail to observe the instructions shown on the label on the battery and charger.*

WARNING

Battery posts, terminals and related accessories contain lead and lead compounds, chemicals known to the State of California to cause cancer and reproductive harm. Wash hands after handling.

Fuse

There are eight fuses in the fuse box under the seat. If the electrical systems do not function, inspect the fuse. Before replacing a fuse, check the wiring harness and electrical equipment for bare wires or other possible causes.

NOTICE

Do not use a fuse of a higher capacity than the specified fuse rating, or damage to the electrical system could result. Refer to the Fuse Location label on the other side fuse case lid.

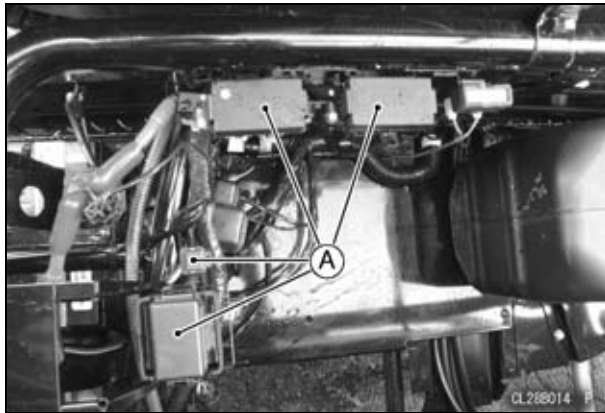

A. Fuse Box

Power Steering System (KAF620M)

There are 40 A and 7.5 A fuses for the power steering system under the front seat.

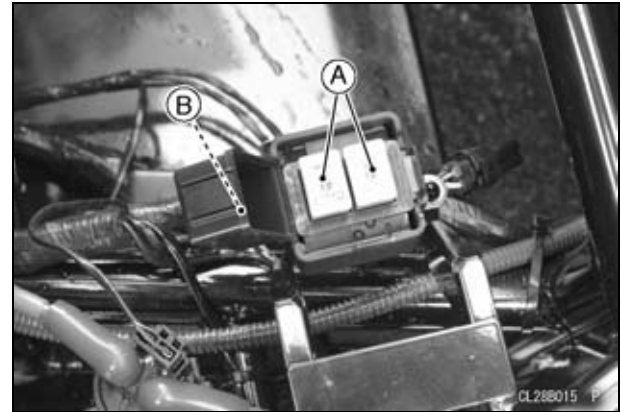

A. 40 A Fuse (Cover removed.)

B. 7.5 A Fuse

If the fuse is blown, steering becomes heavy. Replace the blown fuse with a fuse of the same specific amperage and type. If a replaced fuse blows again, there can be trouble with the ECU or harness/connectors. See an authorized dealer for inspection.

122 MAINTENANCE AND ADJUSTMENT

- You can check the 40 A fuse if it is blown at the top of the fuse.

When replacing the fuse, release the bolted leads first.

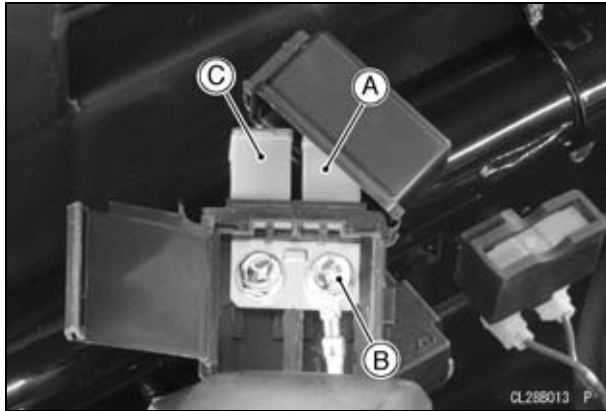

- A. 40 A Fuse
- B. Bolted Lead
- C. Spare Fuse

⚠ WARNING

The electrical system can produce painful electrical shocks. When replacing the 40 A fuse, first remove the cables from the battery terminals to avoid electric shock.

Breaker

The breaker for the radiator fan is located under the seat near the fuse box. If the fan does not function, inspect the breaker. In order to reset the breaker, push the button at the side of the breaker case. Before resetting, however, check that the radiator fan is free from mud or other obstacle as well as the wiring harness and electrical equipment for bare wires or other possible causes.

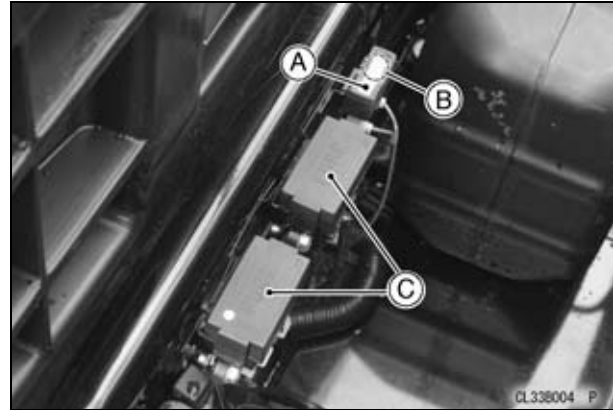

- A. Breaker
- B. Reset Button
- C. Fuse Box

NOTE

- *When you touch the cooling fan, be sure to disconnect the (-) cable of the battery, since the cooling fan can turn automatically even with the ignition switch off.*

General Lubrication

In accordance with the Periodic Maintenance Chart, have the general lubrication performed by an authorized Kawasaki dealer or perform it referring to the Service Manual for this vehicle.

Cleaning

To prolong the life of your vehicle, wash it down immediately after it has been splashed with sea water or exposed to salt air, or operated on rainy days, rough terrain, or in dusty areas.

WARNING

Build-up of debris or flammable material in and around the vehicle chassis, engine, and exhaust can cause mechanical problems and increase the risk of fire. When operating the vehicle in conditions that allow debris or flammable material to collect in and around the vehicle, inspect the engine, electrical component and exhaust areas frequently. If debris or flammable materials have collected, park the vehicle outside and stop the engine. Allow the engine to cool, then remove any collected debris. Do not park or store the vehicle in an enclosed space prior to inspecting for build-up of debris or flammable materials.

Preparation for Washing

Before washing, precautions must be taken to keep water off the following parts.

- Muffler rear opening - cover with a plastic bag.

- Ignition switch - cover the keyhole with tape.
- Air cleaner intake (middle of the rear ROPS top) - close opening with tape, or stuff in rags.
- Horn button - cover with tape.

Where to be Careful

Avoid spraying water with any great force near the following places.

- Front and rear brakes - if water gets into the brake drums, they will not work effectively until they have dried out.
- Under the seat - if water gets into the ignition coils or into the spark plug caps, it can ground out the spark. When this happens the vehicle will not operate properly and the affected parts must be wiped dry.
- Power Steering System – if water gets into the actuator or is sprayed over the ECU, they may cause malfunction. (KAF620M)

NOTICE

Coin operated, high pressure spray washers are not recommended. Water may be forced into bearings and other components causing eventual failure from rust and corrosion. Some soaps are highly alkaline and may leave a residue or cause spotting.

Semi-gloss Finish

To clean the semi-gloss finish;

- When washing the vehicle, always use a mild neutral detergent and water.
- The semi-gloss finish effect may be lost when the finish is excessively rubbed.
- If any doubt, consult an authorized Kawasaki dealer.

After Washing

- Remove the plastic bag and tape, and open the air cleaner intake.
- Lubricate as indicated in the “General Lubrication” section.
- Test the brakes before operation.
- Start the engine and run it for 5 minutes to dry it thoroughly.

Bolt and Nut Tightening

In accordance with the Periodic Maintenance Chart, have the tightness of the bolts, nuts, and fasteners checked by an authorized Kawasaki dealer.

STORAGE

Preparation for Storage:

- Clean the entire vehicle thoroughly.
- Run the engine for about five minutes to warm the oil, shut it off and drain the engine oil.

WARNING

Engine oil is a toxic substance. Dispose of used oil properly. Contact your local authorities for approved disposal methods or possible recycling.

- Put in fresh engine oil.
- Empty the fuel from the fuel tank.

WARNING

Gasoline is extremely flammable and can be explosive under certain conditions. Do not smoke. Turn the ignition switch "OFF". Make sure the area is well ventilated and free from any source of flame or sparks; this includes any appliance with a pilot light.

WARNING

Gasoline is a toxic substance. Dispose of fuel properly. Contact your local authorities for approved disposal methods.

NOTE

- As an alternative to draining the fuel system, a fuel stabilizer, such as STA-BIL, may be used. Follow the manufacturer's instructions for use.

WARNING

Fuel stabilizers may contain poisonous substances. Heed the manufacturer's warnings for use.

- Remove the spark plugs and spray fogging oil, such as Kawasaki K-Kare Fogging Oil (part number K61030-002), directly into each cylinder. Turn the engine over several times with the ignition switch key to coat the cylinder walls. Install the spark plugs.

WARNING

An air/oil mist may be forcibly ejected from the spark plug holes and could get into your eyes. Do not lean over the engine when performing this procedure. If you do get oil in your eyes, wash them immediately with liberal amounts of clean, fresh water and consult a physician as soon as possible.

- Put boards under the front and rear wheels to keep dampness away from the tire rubber.

- Spray oil on all unpainted metal surfaces to prevent rusting. Avoid getting oil on rubber parts or in the brakes.
- Lubricate all the cables as indicated in the General Lubrication section.
- Remove the battery, and store it where it will not be exposed to direct sunlight, moisture, or freezing temperatures. During storage it should be given a slow charge (one ampere or less) about once a month.

NOTICE

**Keep the battery well charged during cold weather so that the electrolyte does not freeze and crack open the battery. The more discharged a battery becomes, the more easily it freezes.
Never remove the sealing strip, or the battery can be damaged.**

- Tie a plastic bag over the exhaust pipe and air cleaner intake (rear ROPS top) to prevent moisture or small animals from entering.

- Put a cover over the vehicle to keep dust and dirt from collecting on it.

Removal from Storage:

⚠ DANGER

Exhaust gas contains carbon monoxide, a colorless, odorless poisonous gas. Inhaling carbon monoxide can cause serious brain injury or death. Do not run the engine in enclosed areas. Operate only in a well-ventilated area.

- Remove the plastic bags from the exhaust pipe and air cleaner intake.
- Clean the terminals of the battery, charge the battery if necessary, and install it in the vehicle.
- Make sure the spark plugs are tight.
- Fill the fuel tank with fuel.
- Check all the points listed in the “Daily Checks” section.
- Lubricate as indicated in the “General Lubrication” section.

TROUBLESHOOTING GUIDE

Starter Motor Won't Turn

- Fuse failed (be sure to check for cause of failure)
- Battery leads do not make good electrical contact with battery terminals
- Battery discharged

Engine Cranks, But Won't Start

- No fuel in tank
- Water in fuel
- Air filter clogged or intake blocked
- Engine flooded
- Fuel tank vent clogged
- Spark plug wire not on spark plug
- Spark plug dirty

Engine Stops

- No fuel in tank
- Water in fuel
- Air filter clogged or intake blocked
- Fuel tank cap vent clogged
- Engine overheated
 - Too much idling or low speed running (not enough air flow)
 - Overloaded
 - Wrong spark plug
 - Radiator clogged
 - Coolant level too low

- Coolant deteriorated
- Cooling fan breaker functioned
- Engine oil low

No Power

- Engine overheated
 - Too much idling or low speed running (not enough air flow)
 - Overloaded
 - Wrong spark plug
 - Radiator clogged
 - Coolant level too low
 - Coolant deteriorated
 - Cooling fan breaker functioned
 - Engine oil low
- Compression leakage
 - Valve clearance insufficient
- Air filter clogged or intake blocked
- Spark plug dirty or worn
- Engine oil incorrect
- Water in fuel

Power Steering Won't Work (KAF620M)

- ECU functioned to prevent overheating.
- Fuse failed
- Battery discharged
- Cable harness/connectors disconnected

YOUR WARRANTY/OWNER SATISFACTION

Welcome to the Kawasaki family!

Congratulations on buying your Kawasaki vehicle. You've chosen a great, high-quality product with state-of-the-art features and built to Kawasaki's high standards. Your satisfaction is important to your authorized Kawasaki dealer and to Kawasaki Motors Corp., U.S.A. Here is some important information regarding your vehicle's limited warranty.

Frequently Asked Questions

What is a Limited Warranty?

The most important thing to know about your warranty is that it protects you from manufacturing defects in material or workmanship during the warranty period. You can find the warranty period in the Kawasaki Limited Warranty Certificate your Kawasaki dealer provided to you at the time of sale. The warranty does not cover the cost of regularly-scheduled maintenance. The warranty also does not apply to the normal wear of items such as tires, brake pads, transmission drive belts, chains, sprockets, etc.

What is the Good Times Protection Plan?

Much of the warranty coverage offered by the limited warranty can be extended by purchasing Kawasaki's Good Time™ Protection Plan (GTPP). See your Kawasaki dealer or go to Kawasaki.com for more information if you don't already have the GTPP.

What Am I Responsible For?

You are responsible for maintaining your vehicle according to the maintenance schedule shown in this owner's manual.

You are responsible for notifying your dealer immediately if there is a problem, and you, as the owner, will need to authorize the dealer to inspect the unit.

130 YOUR WARRANTY/OWNER SATISFACTION

You will be responsible for paying for routine maintenance, including the first scheduled service. You can have the required servicing done by your Kawasaki dealer (recommended) or an equally-qualified service facility. You can also do your own maintenance work if you have the proper tools, service references, and mechanical skills. However, if a failure is found to be caused by improper servicing, it would not be covered by the limited warranty.

You may purchase a Kawasaki Service Manual and any necessary special tools directly from your Kawasaki dealer.

You will be responsible for paying for repairs needed because of an accident, to replace worn parts such as tires, chains, brakes, and for repairs needed because of a lack of maintenance, misuse or racing.

Whether you do it yourself or take your vehicle to a Kawasaki dealer, be sure to record your service in the Maintenance Record section of this Owner's Manual. Keep all receipts for the service and/or items necessary to perform the maintenance so that in the event of a failure you can document the service history.

What Are The Dealership's Responsibilities?

Your Kawasaki dealer offers a wide range of services, parts, accessories, and information on your product and on Kawasaki.

Each dealer is independently owned and operated and is responsible for the dealership's operations, its repair, warranty, and service work, and its personnel.

Your dealer is responsible for completing the set up and pre-delivery service of your new Kawasaki vehicle. The dealership should also explain its operation, maintenance, and warranty provisions so you understand them at the time of purchase or at any other time you have questions.

The dealership is responsible for inspecting your Kawasaki vehicle if there is a failure, investigating the cause of the problem, and getting any needed authorization from Kawasaki if the repair is one that will be covered by the limited warranty. The dealership will also file all necessary paperwork. The dealership is responsible for correctly completing any necessary repairs, whether they are covered by the limited warranty or not.

How Do I Get Warranty Service?

If there is a problem with your vehicle within the limited warranty period, you will need to schedule a service appointment and provide any maintenance records to an authorized Kawasaki dealer for inspection and diagnosis. You can go to any Kawasaki dealer for warranty repairs. Your Kawasaki dealer will inspect your vehicle and give you the results of the inspection. The dealer will perform the repairs at no cost to you if it is determined that the problem is covered by the warranty.

Kawasaki will work with your dealer to resolve any warranty issues. No authorization for warranty work can be given until your vehicle has been inspected by a Kawasaki dealer.

What if I am not Satisfied With My Warranty Service?

If you aren't satisfied with your dealership's repair work or operations, it is best to discuss the situation with the appropriate dealership manager. If you have already done this, then contact the dealership's owner or general manager to request a review of the issue.

If you are unable to resolve a problem after consulting with the dealership management and need further assistance, contact Kawasaki Motors Corp., U.S.A. at the address below. Please be certain to provide the model, vehicle identification number (VIN), mileage or hours of use, accessories, dates that events occurred and what action has been taken by both you and your dealer. Include the name and address of the dealership. To assist us in resolving your inquiry, please include copies of related receipts and any other pertinent information including the name of the dealership personnel with whom you have been working. Upon receipt of your correspondence, Kawasaki Motors Corp., U.S.A. will contact the dealership and work with it in resolving your problem.

132 YOUR WARRANTY/OWNER SATISFACTION

Want to Contact Kawasaki?

This owner's manual should answer most of your questions about your Kawasaki. Your Kawasaki dealer should either be able to answer any other questions you might have immediately or be able to find the answer for you.

Please send your correspondence to:

Consumer Services
Kawasaki Motors Corp., U.S.A.
P.O. Box 25252
Santa Ana, CA 92799-5252
(949) 460-5688

ENVIRONMENTAL PROTECTION

Kawasaki subscribes to the guidelines of Tread Lightly! a program dedicated to protecting the great outdoors through education and fostering responsible enjoyment of public lands. When using your Kawasaki Utility Vehicle (UV), please follow these Tread Lightly! guidelines:

Tread Lightly!

Travel responsibly on designated roads and trails or in permitted areas.

Respect the rights of others including private property owners and all recreational trail users, campers and others to allow them to enjoy their recreational activities undisturbed.

Educate yourself by obtaining travel maps and regulations from public agencies, planning for your trip, taking recreation skills classes, and knowing how to use and operate your equipment safely.

Avoid sensitive areas such as meadows, lakeshores, wetlands and streams, unless on designated routes. This protects wildlife habitat and sensitive soils from damage.

Do your part by leaving the area better than you found it, properly disposing of waste, minimizing the use of fire, avoiding the spread of invasive species, restoring degraded areas, and joining a local enthusiast organization.

Properly discard used batteries, tires, engine oil, other vehicle components, or the entire vehicle that you might dispose of in the future. Consult your authorized Kawasaki dealer or local environmental waste agency for their proper disposal procedure.

MAINTENANCE RECORD

Owner Name.....

Address

Phone Number

Engine Number

Vehicle Number.....

Key Code

Selling Dealer Name

Address

Phone Number

Warranty Start Date

Note: Keep this information and a spare key in a secure location.

Date	Traveled Distance	Maintenance Performed	Dealer Name	Dealer Address

KAF620MF/PF

