

Atlas Copco Instruction Manual



Instruction Manual
for AC Generators
English

QAS 80 Pd S3A ESF

1104D-E44TAG1

QAS 100 Pd S3A ESF

1104D-E44TAG2

Atlas Copco

QAS 80-100 Pd S3A ESF

Instruction Manual for AC Generators

Instruction manual	5
Circuit diagrams	147

Original instructions

Printed matter N°
2954 7090 02

05/2015



ATLAS COPCO - PORTABLE ENERGY DIVISION
www.atlascopco.com

Warranty and Liability Limitation

Use only authorized parts.

Any damage or malfunction caused by the use of unauthorized parts is not covered by Warranty or Product Liability.

The manufacturer does not accept any liability for any damage arising from modifications, additions or conversions made without the manufacturer's approval in writing.

Neglecting maintenance or making changes to the setup of the machine can result in major hazards, including fire risk.

While every effort has been made to ensure that the information in this manual is correct, Atlas Copco does not assume responsibility for possible errors.

Copyright 2015, Grupos Electr6genos Europa, S.A.U., Zaragoza, Spain.

Any unauthorized use or copying of the contents or any part thereof is prohibited.

This applies in particular to trademarks, model denominations, part numbers and drawings.



Congratulations on the purchase of your AC generator. It is a solid, safe and reliable machine, built according to the latest technology. Follow the instructions in this booklet and we guarantee you years of trouble free operation. Please read the following instructions carefully before starting to use your machine.

While every effort has been made to ensure that the information in this manual is correct, Atlas Copco does not assume responsibility for possible errors. Atlas Copco reserves the right to make changes without prior notice.

Contents

1	Safety precautions for on-site generators..... 9				
1.1	Introduction..... 9				
1.2	General safety precautions 10				
1.3	Safety during transport and installation..... 11				
1.4	Safety during use and operation 12				
1.5	Safety during maintenance and repair..... 13				
1.6	Tool applications safety 15				
1.7	Battery safety precautions..... 15				
2	Main parts 16				
2.1	General description 16				
2.2	Markings 18				
2.3	Mechanical features..... 19				
2.3.1	Engine and alternator 19	2.3.6	Data plate and serial number..... 19		
2.3.2	Cooling system..... 19	2.3.7	Drain plugs and filler caps..... 19		
2.3.3	Safety devices 19	2.3.8	Spillage free skid..... 19		
2.3.4	Bodywork..... 19	2.4	Electrical features..... 20		
2.3.5	Control panel..... 19	2.4.1	Control and indicator panels..... 20		
		2.4.1.1	Control panel with Qc1002™ controller..... 20		
		2.4.1.2	Control panel with Qc2002™ controller..... 21		
		2.4.1.3	Control panel with Qc1103™ controller..... 21		
		2.4.1.4	Control panel with Qc2103™ controller..... 22		
		2.4.1.5	Control panel with Qc4002™ MkII controller..... 23		
		2.4.2	Output terminal board 24		
		3	Installation and connection 25		
		3.1	Lifting 25		
		3.2	Installation 25		
		3.2.1	Indoor installation 25		
		3.2.2	Outdoor installation 25		
		3.3	Connecting the generator 26		
		3.3.1	Precautions for non-linear and sensitive loads 26		
		3.3.2	Quality, minimum section and maximum length of cables..... 26		
		3.3.3	Connecting the load 27		
		4	Operating instructions..... 28		
		4.1	Before starting..... 28		
		4.2	Operating and setting Qc1002™ 28		
		4.2.1	Starting..... 28		
		4.2.2	During operation 29		
		4.2.3	Stopping..... 29		
		4.2.4	Setting the Qc1002™ 30		
		4.2.4.1	Push button and LED functions 30		
		4.2.4.2	Qc1002™ menu overview..... 31		
		4.2.4.3	Qc1002™ menu description 31		
		4.2.4.4	Parameter list..... 33		
		4.2.4.5	LOG list..... 36		
		4.2.4.6	Remote start operation 36		

4.3	Operating and setting Qc2002™37	4.5.4	Setting the Qc2103™	60	5	Maintenance 87
4.3.1	Starting	4.5.4.1	Push button and LED functions	60	5.1	Maintenance schedule 87
4.3.2	During operation	4.5.4.2	Qc2103™ menu overview	61	5.1.1	Use of maintenance schedule
4.3.3	Stopping	4.5.4.3	Running modes	66	5.1.2	Use of service paks
4.3.4	Setting the Qc2002™	4.5.4.4	Application modes	66	5.2	Preventing low loads 93
4.3.4.1	Push button and LED functions	4.5.4.5	Parameter settings	67	5.3	Alternator maintenance procedures 94
4.3.4.2	Qc2002™ menu overview	4.5.4.6	LOG list	68	5.3.1	Measuring the alternator insulation resistance
4.3.4.3	Qc2002™ menu description	4.6	Operating and setting Qc4002™ MkII 69	69	5.4	Engine maintenance procedures 94
4.3.4.4	Parameter list	4.6.1	Starting	69	5.4.1	Engine oil level check
4.3.4.5	LOG list	4.6.2	During operation	69	5.4.2	Engine oil and oil filter change
4.4	Operating and setting Qc1103™ 49	4.6.3	Stopping	69	5.4.3	Coolant check
4.4.1	Starting	4.6.4	Setting the Qc4002™ MkII	70	5.4.3.1	Monitoring coolant condition
4.4.2	During operation	4.6.4.1	Push button and LED functions	70	5.4.3.2	Topping up of coolant
4.4.3	Stopping	4.6.4.2	Qc4002™ MkII menu overview	72	5.4.3.3	Replacing the coolant
4.4.4	Setting the Qc1103™	4.6.4.3	Changing settings	75	5.5	Adjustments and service procedures 97
4.4.4.1	Push button and LED functions	4.6.4.4	Standard modes	76	5.5.1	Cleaning coolers
4.4.4.2	Qc1103™ menu overview	4.6.4.5	Standard applications	77	5.5.2	Cleaning fuel tank
4.4.4.3	Running modes	4.6.4.6	Paralleling	83	5.5.3	Battery care
4.4.4.4	Application modes	4.6.4.7	Overview of applications	84	5.5.3.1	Electrolyte
4.4.4.5	Parameter settings				5.5.3.2	Activating a dry-charged battery
4.4.4.6	LOG list				5.5.3.3	Recharging a battery
4.5	Operating and setting Qc2103™ 58				5.5.3.4	Make-up distilled water
4.5.1	Starting				5.5.3.5	Periodic battery service
4.5.2	During operation				5.5.4	Servicing air filter engine
4.5.3	Stopping				5.5.4.1	Main parts
					5.5.4.2	Recommendation

5.5.4.3	Cleaning the dust trap	99	6.4.2.3	Solving alarms.....	112	9.3.4	Outlet sockets (S) - Set 1.....	120
5.5.4.4	Replacing the air filter element.....	99	6.4.3	Qc4002™ MkII alarms and remedies	114	9.3.5	Outlet sockets (S) - Set 2.....	121
5.5.5	Replacing fuel filter element	100	6.4.3.1	Fail Classes	114	9.3.6	Outlet sockets (S) - Set 3 QAS 80	122
5.6	Engine consumable specifications.....	100	6.4.3.2	Diagnostics menu.....	114	9.3.7	Outlet sockets (S) - Set 3 QAS 100	123
5.6.1	Engine fuel specifications.....	100	6.4.3.3	Solving alarms.....	115	9.3.8	Dual frequency (DF)	124
5.6.2	Engine oil specifications.....	100	7	Storage of the generator.....	116	9.3.9	Dual voltage (2V).....	124
5.6.3	Engine coolant specifications	102	7.1	Storage.....	116	9.3.10	Earth leakage relay.....	126
6	Checks and trouble shooting.....	103	7.2	Preparing for operation after storage	116	9.3.11	IT-relay	127
6.1	Checks.....	103	8	Disposal	117	9.3.12	“Electricité de France” (EDF).....	128
6.1.1	Checking voltmeter P4.....	103	8.1	General.....	117	9.3.13	COSMOS™	128
6.1.2	Checking ammeters P1, P2 and P3	103	8.2	Disposal of materials	117	9.3.14	Power Transfer Box (PTB)	129
6.2	Engine troubleshooting.....	103	9	Options available for QAS 80-100 units	118	9.4	Overview of the mechanical options	130
6.3	Alternator troubleshooting.....	106	9.1	Circuit diagrams.....	118	9.5	Description of the mechanical options	130
6.4	Solving controller alarms.....	107	9.2	Overview of the electrical options	118	9.5.1	External fuel tank connection (with/without quick couplings)	130
6.4.1	Qc1002™ and Qc2002™ alarms and remedies	107	9.3	Description of the electrical options	119	9.5.2	Undercarriage (axle, towbar, towing eyes)	131
6.4.1.1	Alarm overview	107	9.3.1	Automatic battery charger.....	119	9.5.3	Integrated spark arrestor	131
6.4.1.2	Fail classes.....	108	9.3.2	Battery switch.....	119	9.5.4	Air inlet shut-off valve.....	131
6.4.1.3	Solving alarms	108	9.3.3	Engine coolant heater	119			
6.4.2	Qc1103™ and Qc2103™ alarms and remedies	111						
6.4.2.1	Alarm handling.....	111						
6.4.2.2	Fail classes.....	111						

10	Technical specifications	132
10.1	Technical specifications for QAS 80 units.....	132
10.2	Technical specifications for QAS 100 units.....	139
10.3	Conversion list of SI units into British units	146
10.4	Data plate	146

1 Safety precautions for on-site generators

To be read attentively and acted accordingly before towing, lifting, operating, performing maintenance or repairing the generator.

1.1 Introduction

The policy of Atlas Copco is to provide the users of their equipment with safe, reliable and efficient products. Factors taken into account are among others:

- the intended and predictable future use of the products, and the environments in which they are expected to operate,
- applicable rules, codes and regulations,
- the expected useful product life, assuming proper service and maintenance,
- providing the manual with up-to-date information.

Before handling any product, take time to read the relevant instruction manual. Besides giving detailed operating instructions, it also gives specific information about safety, preventive maintenance, etc.

Keep the manual always at the unit location, easy accessible to the operating personnel.

See also the safety precautions of the engine and possible other equipment, which are separately sent along or are mentioned on the equipment or parts of the unit.

These safety precautions are general and some statements will therefore not always apply to a particular unit.

Only people that have the right skills should be allowed to operate, adjust, perform maintenance or repair on Atlas Copco equipment. It is the responsibility of management to appoint operators with the appropriate training and skill for each category of job.

Skill level 1: Operator

An operator is trained in all aspects of operating the unit with the push-buttons, and is trained to know the safety aspects.

Skill level 2: Mechanical technician

A mechanical technician is trained to operate the unit the same as the operator. In addition, the mechanical technician is also trained to perform maintenance and repair, as described in the instruction manual, and is allowed to change settings of the control and safety system. A mechanical technician does not work on live electrical components.

Skill level 3: Electrical technician

An electrical technician is trained and has the same qualifications as both the operator and the mechanical technician. In addition, the electrical technician may carry out electrical repairs within the various enclosures of the unit. This includes work on live electrical components.

Skill level 4: Specialist from the manufacturer

This is a skilled specialist sent by the manufacturer or its agent to perform complex repairs or modifications to the equipment.

In general it is recommended that not more than two people operate the unit, more operators could lead to unsafe operating conditions. Take necessary steps to keep unauthorized persons away from the unit and eliminate all possible sources of danger at the unit.

When handling, operating, overhauling and/or performing maintenance or repair on Atlas Copco equipment, the mechanics are expected to use safe engineering practices and to observe all relevant local safety requirements and ordinances. The following list is a reminder of special safety directives and precautions mainly applicable to Atlas Copco equipment.

Neglecting the safety precautions may endanger people as well as environment and machinery:

- endanger people due to electrical, mechanical or chemical influences,
- endanger the environment due to leakage of oil, solvents or other substances,
- endanger the machinery due to function failures.

All responsibility for any damage or injury resulting from neglecting these precautions or by non-observance of ordinary caution and due care required in handling, operating, maintenance or repair, also if not expressly mentioned in this instruction manual, is disclaimed by Atlas Copco.

The manufacturer does not accept any liability for any damage arising from the use of non-original parts and for modifications, additions or conversions made without the manufacturer's approval in writing.

If any statement in this manual does not comply with local legislation, the stricter of the two shall be applied.

Statements in these safety precautions should not be interpreted as suggestions, recommendations or inducements that it should be used in violation of any applicable laws or regulations.

1.2 General safety precautions

- 1 The owner is responsible for maintaining the unit in a safe operating condition. Unit parts and accessories must be replaced if missing or unsuitable for safe operation.
- 2 The supervisor, or the responsible person, shall at all times make sure that all instructions regarding machinery and equipment operation and maintenance are strictly followed and that the machines with all accessories and safety devices, as well as the consuming devices, are in good repair, free of abnormal wear or abuse, and are not tampered with.
- 3 Whenever there is an indication or any suspicion that an internal part of a machine is overheated, the machine shall be stopped but no inspection covers shall be opened before sufficient cooling time has elapsed; this to avoid the risk of spontaneous ignition of oil vapour when air is admitted.
- 4 Normal ratings (pressures, temperatures, speeds, etc.) shall be durably marked.
- 5 Operate the unit only for the intended purpose and within its rated limits (pressure, temperature, speeds, etc.).
- 6 The machinery and equipment shall be kept clean, i.e. as free as possible from oil, dust or other deposits.
- 7 To prevent an increase in working temperature, inspect and clean heat transfer surfaces (cooler fins, intercoolers, water jackets, etc.) regularly. See the maintenance schedule.
- 8 All regulating and safety devices shall be maintained with due care to ensure that they function properly. They may not be put out of action.
- 9 Pressure and temperature gauges shall be checked regularly with regard to their accuracy. They shall be replaced whenever outside acceptable tolerances.
- 10 Safety devices shall be tested as described in the maintenance schedule of the instruction manual to determine that they are in good operating condition.
- 11 Mind the markings and information labels on the unit.
- 12 In the event the safety labels are damaged or destroyed, they must be replaced to ensure operator safety.
- 13 Keep the work area neat. Lack of order will increase the risk of accidents.

14 When working on the unit, wear safety clothing. Depending on the kind of activities these are: safety glasses, ear protection, safety helmet (including visor), safety gloves, protective clothing, safety shoes. Do not wear the hair long and loose (protect long hair with a hairnet), or wear loose clothing or jewellery.

15 Take precautions against fire. Handle fuel, oil and anti-freeze with care because they are inflammable substances. Do not smoke or approach with naked flame when handling such substances. Keep a fire-extinguisher in the vicinity.

16a On-site generators (with earthing pin):

Earth the generator as well as the load properly.

16b On-site generators IT:

Note: This generator is built to supply a sheer alternating current IT network.

Earth the load properly.

1.3 Safety during transport and installation

To lift a unit, all loose or pivoting parts, e.g. doors and towbar, shall first be securely fastened.

Do not attach cables, chains or ropes directly to the lifting eye; apply a crane hook or lifting shackle meeting local safety regulations. Never allow sharp bends in lifting cables, chains or ropes.

Helicopter lifting is not allowed.

It is strictly forbidden to dwell or stay in the risk zone under a lifted load. Never lift the unit over people or residential areas. Lifting acceleration and deceleration shall be kept within safe limits.

1 Before towing the unit:

- check the towbar, the brake system and the towing eye. Also check the coupling of the towing vehicle,
- check the towing and brake capability of the towing vehicle,
- check that the towbar, jockey wheel or stand leg is safely locked in the raised position,
- ascertain that the towing eye can swivel freely on the hook,
- check that the wheels are secure and that the tyres are in good condition and inflated correctly,
- connect the signalisation cable, check all lights and connect the pneumatic brake couplers,
- attach the safety break-away cable or safety chain to the towing vehicle,
- remove wheel chocks, if applied, and disengage the parking brake.

2 To tow a unit use a towing vehicle of ample capacity. Refer to the documentation of the towing vehicle.

3 If a unit is to be backed up by a towing vehicle, disengage the overrun brake mechanism (if it is not an automatic mechanism).

4 In case of transporting a non-trailer unit on a truck, fasten it to the truck by attaching straps via fork lift slots, via the holes in the frame at the front and back or via the lifting beam. To prevent damage, never put straps on the roof surface of the unit.

5 Never exceed the maximum towing speed of the unit (mind the local regulations).

6 Place the unit on level ground and apply the parking brake before disconnecting the unit from the towing vehicle. Unclip the safety break-away cable or safety chain. If the unit has no parking brake or jockey wheel, immobilize the unit by placing chocks in front of and/or behind the wheels. When the towbar can be positioned vertically, the locking device must be applied and kept in good order.

7 To lift heavy parts, a hoist of ample capacity, tested and approved according to local safety regulations, shall be used.

8 Lifting hooks, eyes, shackles, etc., shall never be bent and shall only have stress in line with their design load axis. The capacity of a lifting device diminishes when the lifting force is applied at an angle to its load axis.

9 For maximum safety and efficiency of the lifting apparatus all lifting members shall be applied as near to perpendicular as possible. If required, a lifting beam shall be applied between hoist and load.

10 Never leave a load hanging on a hoist.

11 A hoist has to be installed in such a way that the object will be lifted perpendicular. If that is not possible, the necessary precautions must be taken to prevent load-swinging, e.g. by using two hoists, each at approximately the same angle not exceeding 30° from the vertical.

12 Locate the unit away from walls. Take all precautions to ensure that hot air exhausted from the engine and driven machine cooling systems cannot be recirculated. If such hot air is taken in by the engine or driven machine cooling fan, this may cause overheating of the unit; if taken in for combustion, the engine power will be reduced.

13 Generators shall be stalled on an even, solid floor, in a clean location with sufficient ventilation. If the floor is not level or can vary in inclination, consult Atlas Copco.

14 The electrical connections shall correspond to local codes. The machines shall be earthed and protected against short circuits by fuses or circuit breakers.

15 Never connect the generator outlets to an installation which is also connected to a public mains.

16 Before connecting a load, switch off the corresponding circuit breaker, and check whether frequency, voltage, current and power factor comply with the ratings of the generator.

17 Before transportation of the unit, switch off all the circuit breakers.

1.4 Safety during use and operation

- 1 When the unit has to operate in a fire-hazardous environment, each engine exhaust has to be provided with a spark arrestor to trap incendiary sparks.
- 2 The exhaust contains carbon monoxide which is a lethal gas. When the unit is used in a confined space, conduct the engine exhaust to the outside atmosphere by a pipe of sufficient diameter; do this in such a way that no extra back pressure is created for the engine. If necessary, install an extractor. Observe any existing local regulations.

Make sure that the unit has sufficient air intake for operation. If necessary, install extra air intake ducts.
- 3 When operating in a dust-laden atmosphere, place the unit so that dust is not carried towards it by the wind. Operation in clean surroundings considerably extends the intervals for cleaning the air intake filters and the cores of the coolers.
- 4 Never remove a filler cap of the cooling water system of a hot engine. Wait until the engine has sufficiently cooled down.
- 5 Never refill fuel while the unit is running, unless otherwise stated in the Atlas Copco Instruction Book (AIB). Keep fuel away from hot parts such as air outlet pipes or the engine exhaust. Do not smoke when fuelling. When fuelling from an automatic pump, an earthing cable should be connected to the unit to discharge static electricity. Never spill nor leave oil, fuel, coolant or cleansing agent in or around the unit.
- 6 All doors shall be shut during operation so as not to disturb the cooling air flow inside the bodywork and/or render the silencing less effective. A door should be kept open for a short period only e.g. for inspection or adjustment.
- 7 Periodically carry out maintenance works according to the maintenance schedule.
- 8 Stationary housing guards are provided on all rotating or reciprocating parts not otherwise protected and which may be hazardous to personnel. Machinery shall never be put into operation, when such guards have been removed, before the guards are securely reinstalled.
- 9 Noise, even at reasonable levels, can cause irritation and disturbance which, over a long period of time, may cause severe injuries to the nervous system of human beings.

When the sound pressure level, at any point where personnel normally has to attend, is:

 - below 70 dB(A): no action needs to be taken,
 - above 70 dB(A): noise-protective devices should be provided for people continuously being present in the room,
 - below 85 dB(A): no action needs to be taken for occasional visitors staying a limited time only,
 - above 85 dB(A): room to be classified as a noise-hazardous area and an obvious warning shall be placed permanently at each entrance to alert people entering the room, for even relatively short times, about the need to wear ear protectors,
- above 95 dB(A): the warning(s) at the entrance(s) shall be completed with the recommendation that also occasional visitors shall wear ear protectors,
- above 105 dB(A): special ear protectors that are adequate for this noise level and the spectral composition of the noise shall be provided and a special warning to that effect shall be placed at each entrance.
- 10 The unit has parts of which the temperature can be in excess of 80 °C (176 °F), and which may be accidentally touched by personnel when opening the machine during or just after operation. Insulation or safety guards protecting these parts shall not be removed before the parts have cooled down sufficiently, and must be re-installed before operating the machine. As it is not possible to insulate or protect all hot parts by guards (e.g. exhaust manifold, exhaust turbine), the operator / service engineer must always be aware not to touch hot parts when opening a machine door.
- 11 Never operate the unit in surroundings where there is a possibility of taking in flammable or toxic fumes.
- 12 If the working process produces fumes, dust or vibration hazards, etc., take the necessary steps to eliminate the risk of personnel injury.
- 13 When using compressed air or inert gas to clean down equipment, do so with caution and use the appropriate protection, at least safety glasses, for the operator as well as for any bystander. Do not apply compressed air or inert gas to your skin or direct an air or gas stream at people. Never use it to clean dirt from your clothes.

- 14 When washing parts in or with a cleaning solvent, provide the required ventilation and use appropriate protection such as a breathing filter, safety glasses, rubber apron and gloves, etc.
- 15 Safety shoes should be compulsory in any workshop and if there is a risk, however small, of falling objects, wearing of a safety helmet should be included.
- 16 If there is a risk of inhaling hazardous gases, fumes or dust, the respiratory organs must be protected and depending on the nature of the hazard, so must the eyes and skin.
- 17 Remember that where there is visible dust, the finer, invisible particles will almost certainly be present too; but the fact that no dust can be seen is not a reliable indication that dangerous, invisible dust is not present in the air.
- 18 Never operate the generator in excess of its limits as indicated in the technical specifications and avoid long no-load sequences.
- 19 Never operate the generator in a humid atmosphere. Excessive moisture reduces the generator insulation.
- 20 Do not open electrical cabinets, cubicles or other equipment while voltage is supplied. If such cannot be avoided, e.g. for measurements, tests or adjustments, have the action carried out by a qualified electrician only, with appropriate tools, and ascertain that the required bodily protection against electrical hazards is applied.
- 21 Never touch the power terminals during operation of the machine.
- 22 Whenever an abnormal condition arises, e.g. excessive vibration, noise, odour, etc., switch the circuit breakers to OFF and stop the engine. Correct the faulty condition before restarting.
- 23 Check the electric cables regularly. Damaged cables and insufficient tightening of connections may cause electric shocks. Whenever damaged wires or dangerous conditions are observed, switch the circuit breakers to OFF and stop the engine. Replace the damaged wires or correct the dangerous condition before restarting. Make sure that all electric connections are securely tightened.
- 24 Avoid overloading the generator. The generator is provided with circuit breakers for overload protection. When a breaker has tripped, reduce the concerned load before restarting.
- 25 If the generator is used as stand-by for the mains supply, it must not be operated without control system which automatically disconnects the generator from the mains when the mains supply is restored.
- 26 Never remove the cover of the output terminals during operation. Before connecting or disconnecting wires, switch off the load and the circuit breakers, stop the machine and make sure that the machine cannot be started inadvertently or there is any residual voltage on the power circuit.
- 27 Running the generator at low load for long periods will reduce the lifetime of the engine.
- 28 When operating the generator in Remote or Auto mode, observe all relevant local legislation.

1.5 Safety during maintenance and repair

Maintenance, overhaul and repair work shall only be carried out by adequately trained personnel; if required, under supervision of someone qualified for the job.

- 1 Use only the correct tools for maintenance and repair work, and only tools which are in good condition.
- 2 Parts shall only be replaced by genuine Atlas Copco replacement parts.
- 3 All maintenance work, other than routine attention, shall only be undertaken when the unit is stopped. Steps shall be taken to prevent inadvertent starting. In addition, a warning sign bearing a legend such as “work in progress; do not start” shall be attached to the starting equipment.
On engine-driven units the battery shall be disconnected and removed or the terminals covered by insulating caps.
On electrically driven units the main switch shall be locked in open position and the fuses shall be taken out. A warning sign bearing a legend such as “work in progress; do not supply voltage” shall be attached to the fuse box or main switch.
- 4 Prior to stripping an engine or other machine or undertaking major overhaul on it, prevent all movable parts from rolling over or moving.

- 5 Make sure that no tools, loose parts or rags are left in or on the machine. Never leave rags or loose clothing near the engine air intake.
- 6 Never use flammable solvents for cleaning (fire-risk).
- 7 Take safety precautions against toxic vapours of cleaning liquids.
- 8 Never use machine parts as a climbing aid.
- 9 Observe scrupulous cleanliness during maintenance and repair. Keep away dirt, cover the parts and exposed openings with a clean cloth, paper or tape.
- 10 Never weld on or perform any operation involving heat near the fuel or oil systems. Fuel and oil tanks must be completely purged, e.g. by steam-cleaning, before carrying out such operations. Never weld on, or in any way modify, pressure vessels. Disconnect the alternator cables during arc welding on the unit.
- 11 Support the towbar and the axle(s) securely if working underneath the unit or when removing a wheel. Do not rely on jacks.
- 12 Do not remove any of, or tamper with, the sound-damping material. Keep the material free of dirt and liquids such as fuel, oil and cleansing agents. If any sound-damping material is damaged, replace it to prevent the sound pressure level from increasing.
- 13 Use only lubricating oils and greases recommended or approved by Atlas Copco or the machine manufacturer. Ascertain that the selected lubricants comply with all applicable safety regulations, especially with regard to explosion or fire-risk and the possibility of decomposition or generation of hazardous gases. Never mix synthetic with mineral oil.
- 14 Protect the engine, alternator, air intake filter, electrical and regulating components, etc., to prevent moisture ingress, e.g. when steam-cleaning.
- 15 When performing any operation involving heat, flames or sparks on a machine, the surrounding components shall first be screened with non-flammable material.
- 16 Never use a light source with open flame for inspecting the interior of a machine.
- 17 When repair has been completed, the machine shall be barred over at least one revolution for reciprocating machines, several revolutions for rotary ones to ensure that there is no mechanical interference within the machine or driver. Check the direction of rotation of electric motors when starting up the machine initially and after any alteration to the electrical connection(s) or switch gear, to check that the oil pump and the fan function properly.
- 18 Maintenance and repair work should be recorded in an operator's logbook for all machinery. Frequency and nature of repairs can reveal unsafe conditions.
- 19 When hot parts have to be handled, e.g. shrink fitting, special heat-resistant gloves shall be used and, if required, other body protection shall be applied.
- 20 When using cartridge type breathing filter equipment, ascertain that the correct type of cartridge is used and that its useful service life is not surpassed.
- 21 Make sure that oil, solvents and other substances likely to pollute the environment are properly disposed of.
- 22 Before clearing the generator for use after maintenance or overhaul, submit it to a test run, check that the AC power performance is correct and that the control and shutdown devices function correctly.

1.6 Tool applications safety

Apply the proper tool for each job. With the knowledge of correct tool use and knowing the limitations of tools, along with some common sense, many accidents can be prevented.

Special service tools are available for specific jobs and should be used when recommended. The use of these tools will save time and prevent damage to parts.

1.7 Battery safety precautions

When servicing batteries, always wear protecting clothing and glasses.

- 1 The electrolyte in batteries is a sulphuric acid solution which is fatal if it hits your eyes, and which can cause burns if it contacts your skin. Therefore, be careful when handling batteries, e.g. when checking the charge condition.
- 2 Install a sign prohibiting fire, open flame and smoking at the post where batteries are being charged.
- 3 When batteries are being charged, an explosive gas mixture forms in the cells and might escape through the vent holes in the plugs.
Thus an explosive atmosphere may form around the battery if ventilation is poor, and can remain in and around the battery for several hours after it has been charged. Therefore:
 - never smoke near batteries being, or having recently been, charged,
 - never break live circuits at battery terminals, because a spark usually occurs.

- 4 When connecting an auxiliary battery (AB) in parallel to the unit battery (CB) with booster cables: connect the + pole of AB to the + pole of CB, then connect the - pole of CB to the mass of the unit. Disconnect in the reverse order.

2 Main parts

2.1 General description

The QAS 80-100 Pd is an AC generator, built for continuous running at sites where no electricity is available or as stand-by in cases of interruption of the mains. The generator operates at 50/60 Hz, 400/480V 3 phase line-to-line with neutral. The QAS 80-100 Pd generator is driven by a fluid-cooled diesel engine, manufactured by PERKINS. An overview of the main parts is given in the diagram below.

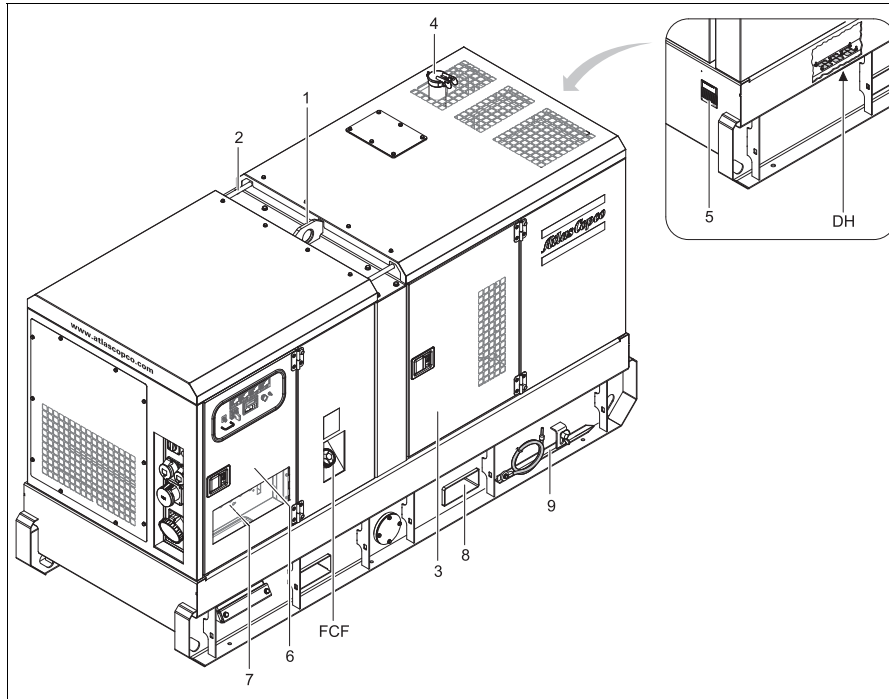

- | | |
|-----|---|
| 1 | Lifting beam |
| 2 | Guiding rod |
| 3 | Side doors |
| 4 | Engine exhaust |
| 5 | Data plate |
| 6 | Door, access to control and indicator panel |
| 7 | Output terminal board |
| 8 | Forklift slots |
| 9 | Earthing rod |
| DH | Drain and access hole (in the frame) |
| FCF | Filler cap fuel |

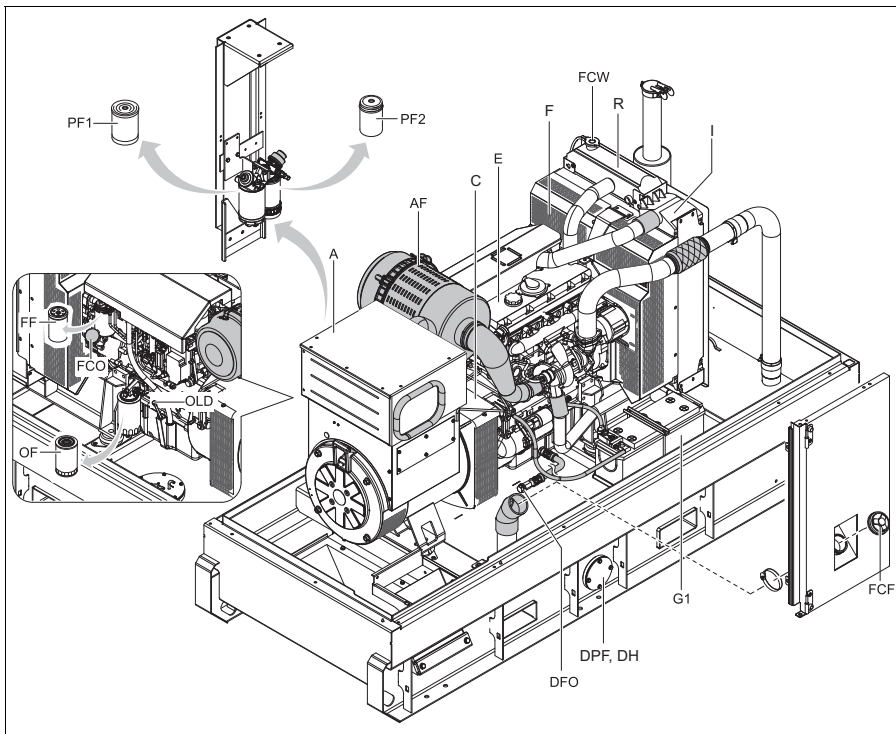

- | | |
|-----|--------------------------------------|
| A | Alternator |
| AF | Air filter |
| C | Coupling |
| DFO | Drain flexible engine oil |
| DH | Drain and access hole (in the frame) |
| DPF | Drain plug fuel |
| E | Engine |
| F | Fan |
| FCF | Filler cap fuel |
| FCO | Filler cap engine oil |
| FCW | Filler cap coolant |
| FF | Fuel filter |
| G1 | Battery |
| I | Intercooler |
| OF | Oil filter |
| OLD | Engine oil level dipstick |
| PF1 | Pre-fuel filter 1 |
| PF2 | Pre-fuel filter 2 |
| R | Radiator |

2.2 Markings

Markings provide instructions and information. They also warn of hazards. For convenience and safety, keep all markings in legible condition, replacing them when damaged or missing. Replacement markings are available from the factory.

A brief description of all markings provided on the generator is given hereafter. The precise location of all markings can be found in the parts manual of this generator.



Indicates the presence of electric shock hazards. Enclosures marked with these symbols should only be opened by trained or instructed people.



Indicates that the engine exhaust is a hot and harmful gas, which is toxic in case of inhalation. Always make sure that the unit is operated outside or in a well-ventilated room.



Indicates that these parts can become very hot during operation (e.g. engine, cooler, etc.). Always make sure that these parts are cooled down before touching them.



Indicates the sound power level in accordance with Directive 2000/14/EC (expressed in dB (A)).



Indicates that the guiding rods may not be used to lift the generator. Always use the lifting rod in the roof of the generator to lift it.



Indicates a lifting point of the generator.



Indicates that the generator may be refuelled with diesel fuel only.



Indicates the drain for the engine oil.



Indicates the drain for the coolant.



Indicates the drain plug for the engine fuel.



Use PAROIL E only.



Indicates the different earthing connections on the generator.



Indicates that the alternator should not be cleaned with high pressurised water.

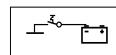

Indicates the battery switch.



Indicates that the unit may start automatically and that the instruction book has to be consulted prior to use.



Read the instruction manual before using the lifting eye.



Indicates the 3-way valve.

Atlas Copco		XXXXXXXXXXXXXXXX
SERVICE PACK		
	XXXXXXXXXXXXXXXX	XXXX XXXX XX
	XXXXXXXXXXXX	XXXX XXXX XX
	XXXXXXXXXXXX	XXXX XXXX XX
Engine oil		
	PAROIL E	PAROIL Extra
	XX XXXXXX XX	XXXX XXXX XX
	XX XXXXXX XX	XXXX XXXX XX
	XX XXXXXX XX	XXXX XXXX XX
Engine coolant		
	PARCOOL EG	
	XX XXXXXX XX	XXXX XXXX XX
	XX XXXXXX XX	XXXX XXXX XX
	XX XXXXXX XX	XXXX XXXX XX

Indicates the part numbers of the different service packs and of the engine oil. These parts can be ordered to the factory.

2.3 Mechanical features

The mechanical features described in this chapter are standard provided on this generator. For all other mechanical features, see “Overview of the mechanical options” on page 130.

2.3.1 Engine and alternator

The alternator is driven by a fluid-cooled diesel engine. The engine’s power is transmitted through a direct disc coupling.

The generator houses a single bearing alternator with a dedicated voltage regulator.

The synchronous brushless alternator has Class H rotor and stator windings in an IP23 housing.

2.3.2 Cooling system

The engine is provided with a water cooler. The cooling air is generated by a fan, driven by the engine.

2.3.3 Safety devices

The engine electronics monitor the engines parameters and generate warning and shut-down signals when the parameters reach a preset threshold value.

2.3.4 Bodywork

The alternator, the engine, the cooling system, etc. are enclosed in a sound-insulated bodywork that can be opened by means of side doors (and service plates).

The generator can be lifted by using the lifting eye integrated in the bodywork (roof). To be able to lift the QAS 80-100 by means of a forklift, rectangular slots are provided in the frame.

The earthing rod, connected to the generator’s earth terminal is located at the bottom of the frame on the outside.

2.3.5 Control panel

The control panel grouping volt and amp meters, control switch etc., is placed at the rear end.

2.3.6 Data plate and serial number

The generator is furnished with a data plate showing the product code, the unit number and the power output (see “Data plate” on page 146).

The serial number is located on the right-hand front side of the frame.

2.3.7 Drain plugs and filler caps

The drain holes for the engine oil, the coolant and the plug for the fuel, are located and labelled on the frame. The fuel drain plugs are located; one at the bottom of the frame and the other at the cubicle side of the frame.

The drain flexible for engine oil can be brought to the outside of the generator through the drain hole.



The drain hole can also be used to guide external fuel tank connections. When connecting an external fuel tank, use the 3-way valves. Refer to External fuel tank connection (with/without quick couplings).

The filler cap for the engine coolant is accessible via an opening in the roof. The fuel filler cap is located in the side panel.

2.3.8 Spillage free skid

A Spillage free skid with forklift slots allows the customer to transport the generator easily with a forklift. It avoids accidental spilling of engine fluids and thus helps to protect the environment.

The leaking fluid can be removed via drain holes, secured by drain plugs. Tighten the plugs firmly and check for leakages. When removing the leaking fluid, observe all relevant local legislation.

2.4 Electrical features

The electrical features described in this chapter are standard provided on this generator. For all other electrical features, see “Overview of the electrical options” on page 118.

2.4.1 Control and indicator panels

To operate the generator, the QAS 80-100 control panel contains a Qc1002™, Qc2002™, Qc1103™, Qc2103™ or Qc4002™ MkII controller. This controller is located inside the control cubicle, and communicates via a display located at the front. The controller will carry out all necessary tasks to control and protect the generator, which allows operation in many different applications.

2.4.1.1 Control panel with Qc1002™ controller

General description Qc1002™ control panel

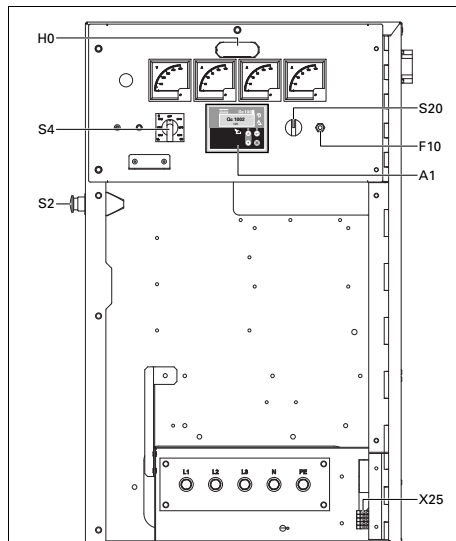

A1 Qc1002™ display

F10 Fuse

The fuse trips when the current from the battery to the engine control circuit exceeds its setting. The fuse can be reset by pushing the button.

H0 Panel light

S2 Emergency stop button

Push the button to stop the generator in case of an emergency. When the button is pressed, it must be unlocked, before the generator can be restarted. The emergency stop button can be secured in the locked position with the key, to avoid unauthorized use.

S20 ON/OFF switch

Position O: No voltage is supplied to the Qc1002™ module, the generator will not start.

Position I: Voltage is supplied to the Qc1002™ module, it is possible to start up the generator.

X25 Terminal strip

Qc1002™ Module

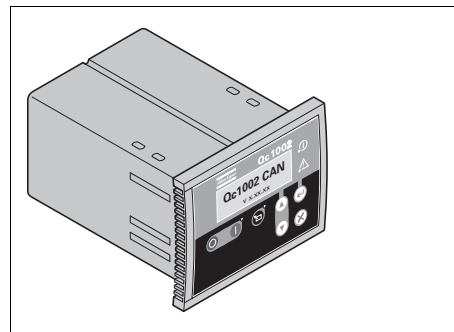

2.4.1.2 Control panel with Qc2002™ controller

General description Qc2002™ control panel

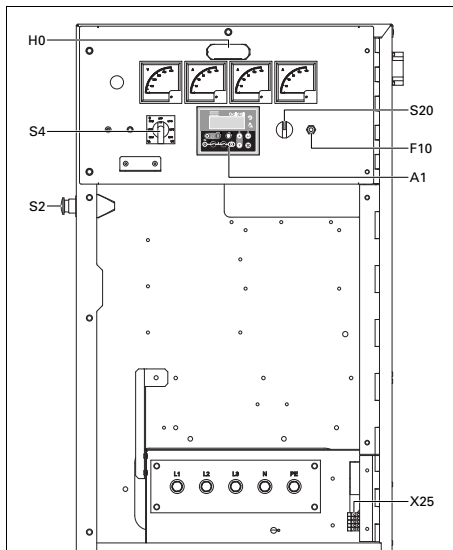

A1 Qc2002™ display

F10 Fuse

The fuse trips when the current from the battery to the engine control circuit exceeds its setting. The fuse can be reset by pushing the button.

H0 Panel light

S2 Emergency stop button

Push the button to stop the generator in case of an emergency. When the button is pressed, it must be unlocked, before the generator can be restarted. The emergency stop button can be secured in the locked position with the key, to avoid unauthorized use.

S20 ON/OFF switch

Position O: No voltage is supplied to the Qc2002™ module, the generator will not start.

Position I: Voltage is supplied to the Qc2002™ module, it is possible to start up the generator.

X25 Terminal strip

Qc2002™ Module

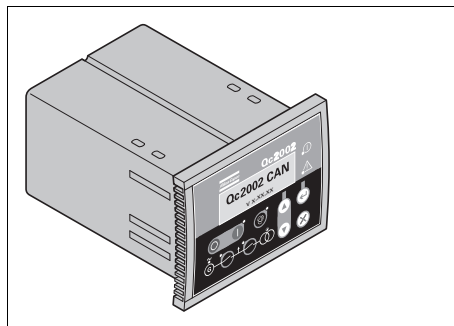

2.4.1.3 Control panel with Qc1103™ controller

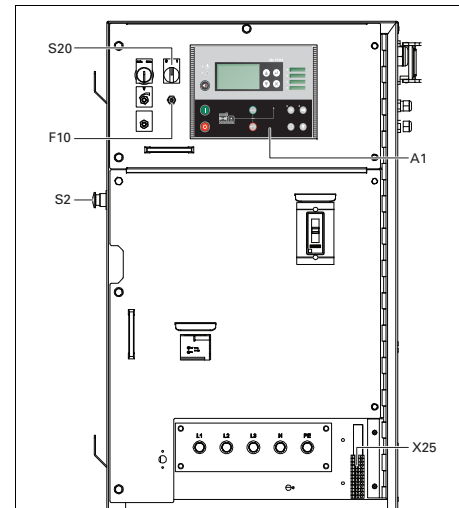

A1 Qc1103™ display

F10 Thermal circuit breaker

The thermal circuit breaker trips when the current from the battery to the engine control circuit exceeds its setting. It can be reset by pushing the button.

S2Emergency stop button

Push the button to stop the generator in case of an emergency. When the button is pressed, it must be unlocked, before the generator can be restarted. The emergency stop button can be secured in the locked position with the key, to avoid unauthorized use.

S20ON/OFF switch

Position O: No voltage is supplied to the Qc1103™ module, the generator will not start.

Position I: Voltage is supplied to the Qc1103™ module, it is possible to start up the generator.

X25 Terminal strip

2.4.1.4 Control panel with Qc2103™ controller

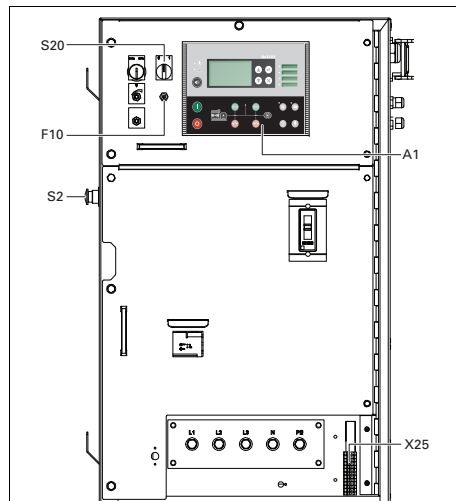

A1 Qc2103™ display

F10..... Thermal circuit breaker

The thermal circuit breaker trips when the current from the battery to the engine control circuit exceeds its setting. It can be reset by pushing the button.

S2.....Emergency stop button

Push the button to stop the generator in case of an emergency. When the button is pressed, it must be unlocked, before the generator can be restarted. The emergency stop button can be secured in the locked position with the key, to avoid unauthorized use.

S20.....ON/OFF switch

Position O: No voltage is supplied to the Qc2103™ module, the generator will not start.

Position I: Voltage is supplied to the Qc2103™ module, it is possible to start up the generator.

X25 Terminal strip

2.4.1.5 Control panel with Qc4002™ MkII controller

General description Qc4002™ MkII control panel

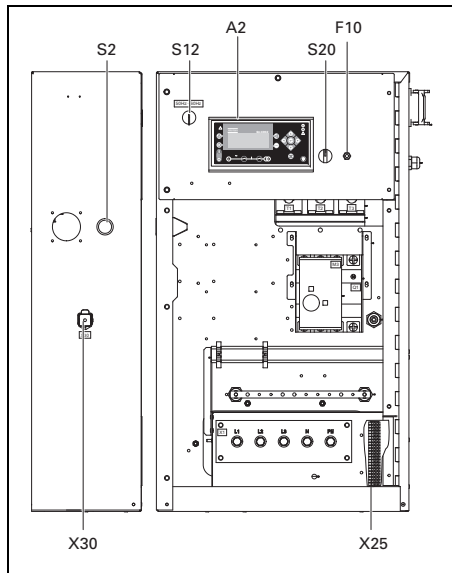

A2 Qc4002™ MkII display

F10 Fuse

The fuse (10 A) trips when the current from the battery to the engine control circuit exceeds its setting. The fuse can be reset by pushing the button.

S2 Emergency stop button

Push the button to stop the generator in case of an emergency. When the button is pressed, it must be unlocked, before the generator can be restarted. The emergency stop button can be secured in the locked position with the key, to avoid unauthorized use.

S12 Frequency selector switch (50 Hz/60 Hz)

Allows to choose the frequency of the output voltage: 50 Hz or 60 Hz.



Changing the output frequency is only allowed when the unit has stopped.

S20 ON/OFF switch

Position O: No voltage is supplied to the Qc4002™ MkII module, the generator will not start.

Position I: Voltage is supplied to the Qc4002™ MkII module, it is possible to start up the generator.

X25 Connection block

Inside the cubicle. Allows customer connections.



Refer to circuit diagram for the correct connection.

X30 Connector X30

Connector for communication with other generators with Qc4002™ MkII when paralleling, both in ALS and PMS mode. An adapter can be plugged in. See page 81.

Qc4002™ MkII module

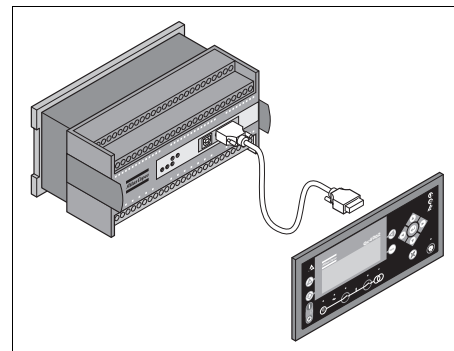

2.4.2 Output terminal board

The cubicle provides a terminal board for easier connection of cables. It is situated below the control and indicator panel.

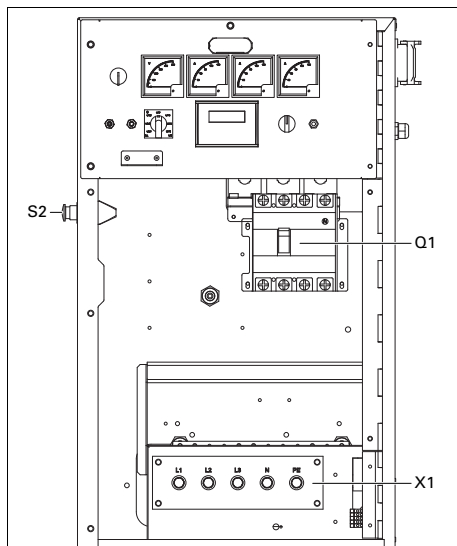

S2Emergency stop button

Push the button to stop the generator in case of an emergency. When the button is pressed, it must be unlocked, by turning it anti-clockwise, before the generator can be restarted. The emergency stop button can be secured in the locked position with the key, to avoid unauthorized use.

Q1Main circuit breaker

Interrupts the power supply to X1 when a short-circuit occurs at the load side, or when the earth leak detector (30 mA) or the overcurrent protection (QAS 80: 125 A, QAS 100: 144 A) is activated or when the shunt trip is energized. It must be reset manually after eliminating the problem.

X1Main power supply (400 V AC)

Terminals L1, L2, L3, N (= neutral) and PE (= earthing), hidden behind the control panel door and behind a small transparent door.

3 Installation and connection

3.1 Lifting

The lifting eye, to lift the generator by means of a hoist, is integrated in the bodywork and easily accessible from the outside. The recesses in the roof have guiding rods at both sides.

When lifting the generator, the hoist has to be placed in such a way that the generator, which must be placed level, will be lifted vertically.

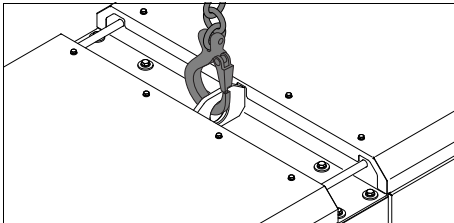

Never use the guiding rods to lift the generator.



Lifting acceleration and deceleration must be kept within safe limits (max. 2 g).

Helicopter lifting is not allowed.

To be able to lift the generator by means of a forklift, rectangular slots are provided at the bottom of the frame.

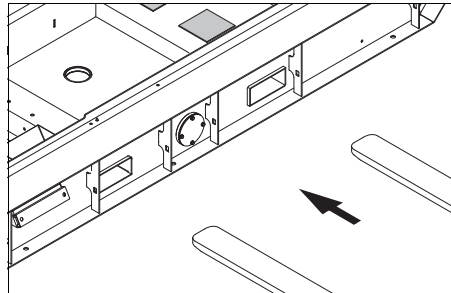

3.2 Installation

3.2.1 Indoor installation

If the generator is operated indoors, install an exhaust pipe of sufficient diameter to duct the engine exhaust towards the outside. Check for sufficient ventilation so that the cooling air is not recirculated.



For more information about indoor installation, consult your local Atlas Copco dealer.

3.2.2 Outdoor installation

- Place the generator on a horizontal, even and solid floor. The generator can operate in a slant position not exceeding 15% (in both senses: front/rear and left/right).
- The generator should be kept with the doors closed, in order to avoid the ingress of water and dust. Dust ingress reduces the lifetime of filters and may reduce your generator's performance.
- Check that the engine exhaust is not directed towards people.
- Locate the rear end of the generator upwind, away from contaminated wind streams and walls. Avoid recirculation of exhaust air from the engine. This causes overheating and engine power decrease.

- Leave enough space for operation, inspection and maintenance (at least 1 meter at each side).
- Check that the inner earthing system is in compliance with the local legislation.
- Use coolant for the engine cooling system. Refer to the Engine instruction book for the proper coolant mixture.
- Check the tightness of the bolts and nuts.
- Check that the cable end of the earthing rod is connected to the earth terminal.



The generator is wired for a TN-system to IEC 364-3, i.e. one point in the power source directly earthed - in this case the neutral. The exposed conductive parts of the electric installation must be directly connected to the functional earth. If operating the generator in another power system, e.g. an IT-system, other protective devices required for these types must be installed. In any case only a qualified electrician is authorized to remove the connection between the neutral (N) and earth terminals in the terminal box of the alternator.

3.3 Connecting the generator

3.3.1 Precautions for non-linear and sensitive loads



Non-linear loads draw currents with high contents in harmonics, causing distortion in the wave form of the voltage generated by the alternator.

The most common non-linear, 3-phase loads are thyristor/rectifier-controlled loads, such as convertors supplying voltage to variable speed motors, uninterruptable power supplies and Telecom supplies. Gas-discharge lighting arranged in single-phase circuits generate high 3rd harmonics and risk for excessive neutral current.

Loads most sensitive to voltage distortion include incandescent lamps, discharge lamps, computers, X-ray equipment, audio amplifiers and elevators.

Consult Atlas Copco for measures against the adverse influence of non-linear loads.

3.3.2 Quality, minimum section and maximum length of cables

The cable connected to the terminal board of the generator must be selected in accordance with local legislation. The type of cable, its rated voltage and current carrying capacity are determined by installation conditions, stress and ambient temperature. For flexible wiring, rubber-sheathed, flexible core conductors of the type H07 RN-F (Cenelec HD.22) or better must be used.

The following table indicates the maximum allowable 3-phase currents (in A), at an ambient temperature of 40°C, for cable types (multiple and single core PVC insulated conductors and H07 RN-F multiple core conductors) and wire sections as listed, in accordance with VDE 0298 installation method C3. Local regulations remain applicable if they are stricter than those proposed below.

Wire section (mm ²)	Max. current (A)		
	Multiple core	Single core	H07 RN-F
2.5	22	25	21
4	30	33	28
6	38	42	36
10	53	57	50
16	71	76	67
25	94	101	88
35	114	123	110
50	138	155	138
70	176	191	170
95	212	228	205

The lowest acceptable wire section and the corresponding maximum cable or conductor length for multiple core cable or H07 RN-F, at rated current (20 A), for a voltage drop e lower than 5% and at a power factor of 0.80, are respectively 2.5 mm² and 144 m. In case electric motors must be started, oversizing the cable is advisable.

The voltage drop across a cable can be determined as follows:

$$e = \frac{\sqrt{3} \cdot I \cdot L \cdot (R \cdot \cos \varphi + X \cdot \sin \varphi)}{1000}$$

e = Voltage drop (V)

I = Rated current (A)

L = Length of conductors (m)

R = Resistance (Ω/km to VDE 0102)

X = Reactance (Ω/km to VDE 0102)

3.3.3 Connecting the load

3.3.3.1 Site distribution panel

If outlet sockets are provided, they must be mounted on a site distribution panel supplied from the terminal board of the generator and in compliance with local regulations for power installations on building sites.

3.3.3.2 Protection



For safety reasons, it is necessary to provide an isolating switch or circuit breaker in each load circuit. Local legislation may impose the use of isolating devices which can be locked.

- Check whether frequency, voltage and current comply with the ratings of the generator.
- Provide a load cable, without excessive length, and lay it out in a safe way without forming coils.

- Open the door of the control and indicator panel and the transparent door in front of the terminal board X1.
- Provide the wire ends with cable lugs suited for the cable terminals.
- Loosen the cable clamp and push the wire ends of the load cable through the orifice and clamp.
- Connect the wires to the proper terminals (L1, L2, L3, N and PE) of X1 and tighten the bolts securely.
- Tighten the cable clamp.
- Close the transparent door in front of X1.

4 Operating instructions



In your own interest, always strictly observe all relevant safety instructions.

Do not operate the generator in excess of the limitations mentioned in the Technical Specifications.

Local rules concerning the setting up of low voltage power installations (below 1000 V) must be respected when connecting site distribution panels, switch gear or loads to the generator.

At each start-up and at any time a new load is connected, the earthing and protections (GB trip and earth leakage relay) of the generator must be verified. Earthing must be done either by the earthing rod or, if available, by an existing, suitable earthing installation. The protective system against excessive contact voltage is not effective unless a suitable earthing is made.

4.1 Before starting

- With the generator standing level, check the engine oil level and top up if necessary. The oil level must be near to, but not exceed the high mark on the engine oil level dipstick.
- Check the coolant level in the expansion tank of the engine cooling system. The coolant level must be near to the FULL mark. Add coolant if necessary.
- Drain any water and sediment from the fuel pre-filter. Check the fuel level and top up if necessary. It is recommended to fill the tank after the day's operation to prevent water vapor in a nearly empty tank from condensing.
- Drain leaking fluid from the frame.
- Check the vacuum indicator of the air filter. If the red part shows completely, replace the filter element.
- Press the dust evacuator of the air filter to remove dust.
- Check the generator for leakage, tightness of wire terminals, etc. Correct if necessary.
- Check that circuit breaker Q1 is switched off.
- Check that fuse F10 has not tripped and that the emergency stop is in the OUT position.
- Check that the load is switched off.
- Check that the earth fault protection (N13) has not tripped (reset if necessary).

4.2 Operating and setting Qc1002™

4.2.1 Starting

To start up the unit locally, proceed as follows:

- Switch on the battery switch.
- Switch off circuit breaker Q1. This is not necessary when a plant contactor is installed between Q1 and the load.
- Put the starter switch S20 in position I (ON). Voltage is supplied to the Qc1002™ module.
- The unit can be started manually by pressing the START button on the Qc1002™ module.
- The unit will start.
In cold conditions the unit might not start from the first attempt. The controller will take 3 start attempts.
- Switch on circuit breaker Q1 in case no contactor is installed.

To start up the unit from a remote location, proceed as follows:

- Put the starter switch S20 in position I (ON). Voltage is supplied to the Qc1002™ module.
- The unit can be started from a remote location by pressing the remote mode button  on the Qc1002™ module.
- Switch on circuit breaker Q1.
- Put the remote start/stop switch in position start.
- The unit will start.
In cold conditions the unit might not start from the first attempt. The controller will take 3 start attempts.

4.2.2 During operation

Regularly carry out following checks:

- Check the analogue meters (P1-P4) and the controller display for normal readings.



Avoid to let the engine run out of fuel. If it happened, priming will speed up the starting.

- Check for leakage of oil, fuel or coolant.



Avoid long low-load periods (<30%). In this case, an output drop and higher oil consumption of the engine could occur. Refer to 'Preventing low loads'.

- Check, by means of the generator gauges, that the voltage between the phases is identical and that the rated current is not exceeded.
- When single-phase loads are connected to the generator output terminals, keep all loads well-balanced.
- If circuit breakers have tripped during operation, switch off the load and stop the generator. Check and, if necessary, decrease the load.



The generator's doors may only remain opened for short periods during operation, to carry out checks for example.

4.2.3 Stopping

To stop the unit locally, proceed as follows:

- Switch off the load.
- Switch off circuit breaker Q1.
- Stop the engine by using the STOP button on the Qc1002™ module.
- Put the starter switch S20 in position O (OFF) to shut down the voltage supply towards the Qc1002™ module.
- Lock all doors to avoid unauthorized access.

To stop the unit when the starter switch is in position , proceed as follows:





- Switch off the load.
- Stop the engine by putting the remote start/stop switch in position stop or by using the STOP button on the Qc1002™ module. When the unit is stopped with the STOP button in Remote Mode, it will automatically go to Manual Mode.
- Put the starter switch S20 in position O (OFF) to shut down the voltage supply towards the Qc1002™ module.
- Lock all doors to avoid unauthorized access.

4.2.4 Setting the Qc1002™

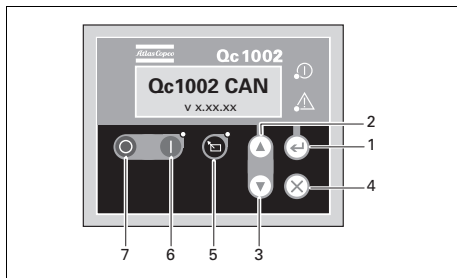
4.2.4.1 Push button and LED functions

Following push buttons are used on the Qc1002™:



- 1  **ENTER:** Is used to select and confirm changed settings in the Parameter list.
- 2  **UP:** Is used to scroll through the display information and to adjust parameter value upwards.
- 3  **DOWN:** Is used to scroll through the display information and to adjust parameter value downwards.
- 4  **BACK:** Is used to leave the Alarm pop-up window, to leave the Parameter list and to leave menu's without change.



REMOTE MODE: Is used to activate the remote mode. The LED indicates if the genset is put in Remote Mode.



START: Is used to start the unit in Manual Mode.



STOP: Is used to stop the unit in Manual or Remote Mode (always with shutdown!). When the unit is stopped with the STOP button in Remote mode, it will automatically go to Manual Mode.

Following LEDs are used on the Qc1002™:

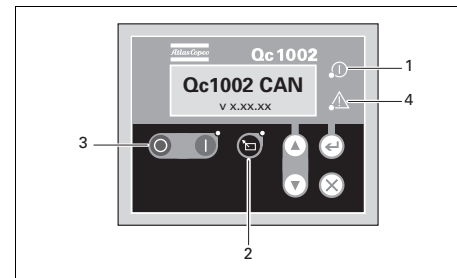

- 1 **Power** Green LED indicates that the unit is powered up.
- 2 **Remote** Green LED indicates that the Remote Mode is selected.
- 3 **Start/Stop** Green LED indicates that the engine is running.
- 4 **Alarm** Flashing red LED indicates that an alarm is present. A continuous red LED indicates that the alarm has been acknowledged by the user. The exact alarm is shown on the display.

4.2.4.2 Qc1002™ menu overview

At Qc1002™, the LCD will show following information:

- in **Normal** condition (scroll through the information using **UP** and **DOWN**):
 - Status (e.g.: preheat, crank, run, cooldown, extended stop time, ...)
 - Controller type & version
 - Parameter list
 - Alarm list
 - LOG list
 - Service Timer 1 & Service Timer 2
 - Battery Voltage
 - Coolant temperature
 - Oil pressure
 - RPM (speed)
 - Fuel level
 - Voltage - frequency - running hours
- in **Alarm** condition (scroll through the information using **UP** and **DOWN**):
 - a list of all active Alarms

It's possible to scroll through the views, using the **UP** and **DOWN** buttons. The scrolling is continuous.

If a Special status occurs, the Status Display is shown.

If an Alarm occurs, the Alarm Display is shown.

4.2.4.3 Qc1002™ menu description

Status display (pop-up window)

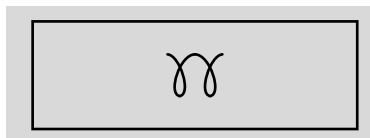

In case special statuses are entered, a pop-up window will automatically be entered for as long as the status is active.

The background screen is not updated when the status pop-up window is active.

These special statuses are:

PREHEAT

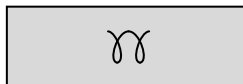

START OFF/
EXTENDED
STOP TIMER



COOLDOWN



DIAGNOSTIC

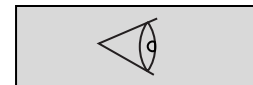

If a special status has elapsed, the active view will be entered again automatically.

If an Alarm occurs, the Alarm Display is shown.

Controller type and version display



This view shows the controller type and the ASW version number.

Parameter display

Parameter

This view shows a number of Parameter settings and gives access to them.

An overview is given in “Parameter list” on page 33.

Alarm list display

Alarm List

0 Alarm(s)

This view shows the number of active alarms and gives access to them.

An overview is given in “Solving alarms” on page 108.

LOG list display

LOG List

This view shows the alarm memory and gives access to it.

An overview is given in “LOG list” on page 36.

Service timer 1 & Service timer 2 display

Service 1	59h
Service 2	59h

This view shows both Service timers. The service timer indication is shown when service time has run out. It can be removed by resetting the timers or acknowledging the Service timer indication.

The service timer indications count and give an alarm when value is reached.

Resetting the Service Timers can be done through the Parameter display.

Battery Voltage display

Battery 13.2 V

00168.1h

This view shows the Battery voltage and the running hours.

Coolant temperature display

Water 62°C

00168.1h

This view shows the Coolant temperature and the running hours.

See also “Parameter list” on page 33 for selection between °C and °F.

Oil pressure display

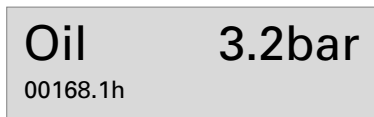

This view shows the Oil pressure and the running hours.

See also "Parameter list" on page 33 for selection between bar and psi.

Fuel level display

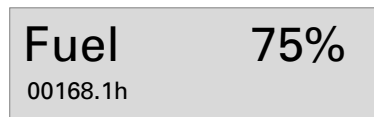

This view shows the Fuel level and the running hours.

Voltage - frequency - running hours display

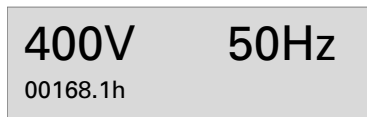

This view shows the voltage, frequency and running hours.

Engine speed display



This view shows the engine speed and running hours.

4.2.4.4 Parameter list

The Parameter Menu's are pre-programmed!

A password will be asked for when an attempt to change a setting is about to be done (user password = 2003).

Menu's shown on the Parameter list LCD:

- Running hours adjust

This menu is used to adjust the amount of running hours. The running hours can only be increased, not decreased.

- Unit Type



Unit type 9 for QAS 80-100 Pd!

- Service Timer 2 reset

- Service Timer 1 reset

These menus are used to reset the service timers. When a service timer alarm occurs and is acknowledged, the service timer will be reset automatically.

- Diagnostic Menu

This menu is used to power up the engine electronics without starting the engine. When this setting is switched on, electric power will be supplied to the engine electronics after half a minute delay. The unit can not be started as long as this parameter is switched on.

- Unit Menu

This menu is used to select whether temperature and pressure should appear in °C/bar or °F/psi.

- Language selection

Icons is the default factory set language, but 6 other languages can be selected: English, French, German, Italian, Spanish and Cyrillic (Russian). All information in the Parameter List display is always in English.

- Generator Underfrequency: fail class, enable, delay, setpoint

- Generator Overfrequency: fail class, enable, delay, setpoint

- Generator Undervoltage: fail class, enable, delay, setpoint

- Generator Overvoltage: fail class, enable, delay, setpoint

- Engine CAN communication

This menu is used to select the type of engine electronics, the Qc1002™ controller should communicate with via the Canbus.

It's possible to scroll between configuration menu's by using the push buttons UP and DOWN.

Pushing the ENTER button activates the configuration menu which is shown at the display.

This is the described menu flow for changing the unit type:

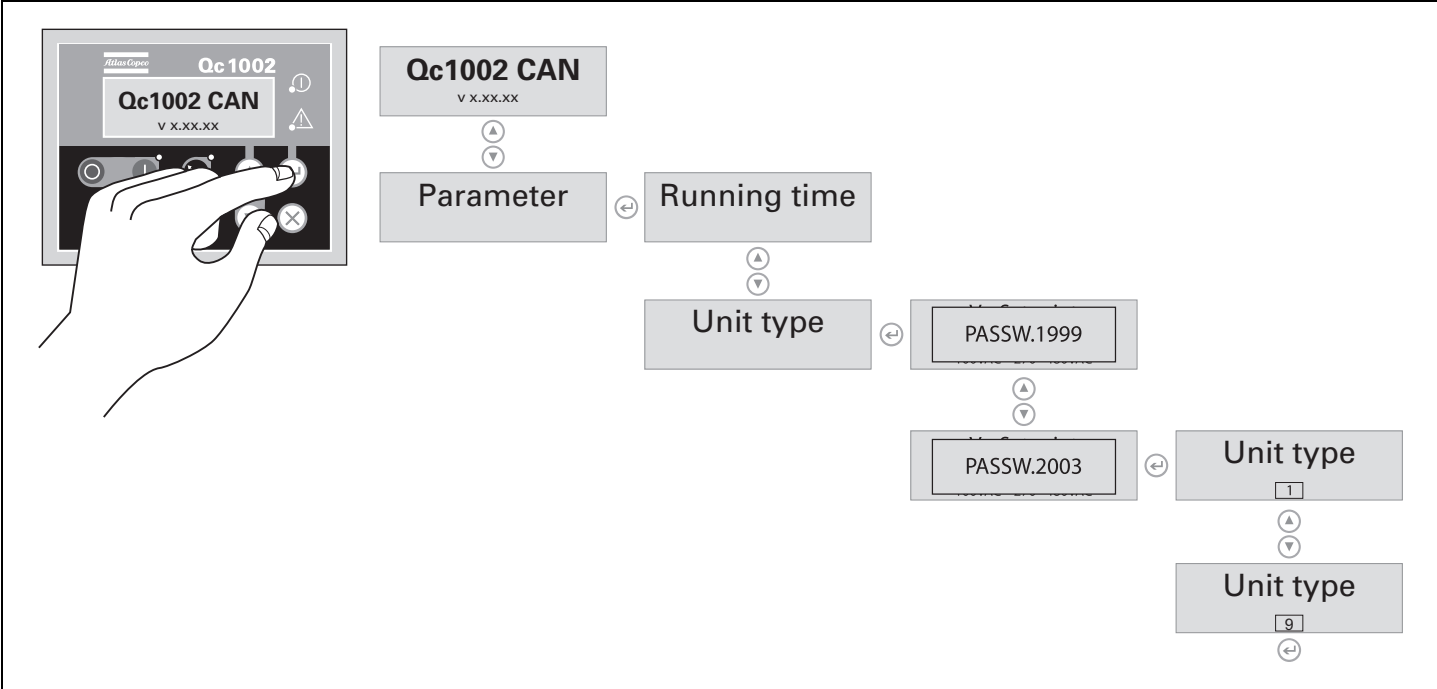

4.2.4.5 LOG list

The unit will keep an event log of the latest 30 events.

Events are:

- shutdowns
- service timer 1/2 reset
- unit type changes

Together with each event, the running hours at the time of the event will be stored.

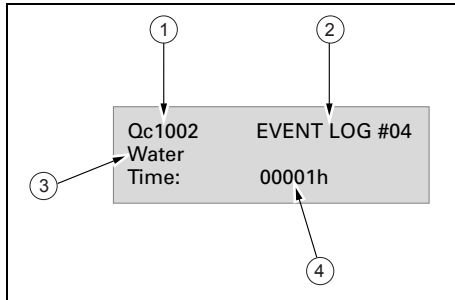

- | | | |
|---|--|-----------------|
| 1 | | Controller type |
| 2 | | Event number |
| 3 | | Event |
| 4 | | Running hours |

4.2.4.6 Remote start operation

Installation wiring:

- X25.1 & X25.2 to be wired for the remote start switch.
- X25.3 & X25.4 to be wired for the remote contactor (open/close).

4.3 Operating and setting Qc2002™

4.3.1 Starting

To start up the unit locally, proceed as follows:

- Switch on the battery switch.
- Switch off circuit breaker Q1. This is not necessary when a plant contactor is installed between Q1 and the load.
- Put the starter switch S20 in position I (ON). Voltage is supplied to the Qc2002™ module.
- The unit can be started manually by pressing the START button on the Qc2002™ module.
- The unit will start.
In cold conditions the unit might not start from the first attempt. The controller will take 3 start attempts.
- Switch on circuit breaker Q1 in case no contactor is installed.

To start up the unit from a remote location, proceed as follows:

- Put the starter switch S20 in position I (ON). Voltage is supplied to the Qc2002™ module.
- Switch on circuit breaker Q1.
- For remote start:
 - Put the unit in Island mode. Push the AUTOMATIC button. Use an external switch to start the machine.
- or
 - Put the unit in AMF mode. Push the AUTOMATIC button. The machine will start automatically when Mains fails.

See also ‘Genset mode’ on page 44 for more detailed information on Island and AMF mode.

- The unit will start.
In cold conditions the unit might not start from the first attempt. The controller will take 3 start attempts.

4.3.2 During operation

Regularly carry out following checks:

- Check the analogue meters (P1-P4) and the controller display for normal readings.



Avoid to let the engine run out of fuel. If it happened, priming will speed up the starting.

- Check for leakage of oil, fuel or coolant.



Avoid long low-load periods (< 30%). In this case, an output drop and higher oil consumption of the engine could occur. Refer to ‘Preventing low loads’.

- Check, by means of the generator gauges, that the voltage between the phases is identical and that the rated current is not exceeded.
- When single-phase loads are connected to the generator output terminals, keep all loads well-balanced.
- If circuit breakers have tripped during operation, switch off the load and stop the generator. Check and, if necessary, decrease the load.



The generator’s doors may only remain opened for short periods during operation, to carry out checks for example.

4.3.3 Stopping

To stop the unit, proceed as follows:

- Switch off the load.
- Switch off circuit breaker Q1.
- Stop the engine by using the STOP button on the Qc2002™ module.
- Put the starter switch S20 in position O (OFF) to shut down the voltage supply towards the Qc2002™ module.
- Lock all doors to avoid unauthorized access.

To stop the unit when the Qc2002™ module is in AUTOMATIC operation mode, proceed as follows:

- Switch off the load.
- For remote start:
 - When operating in Island mode, use the external switch to stop the machine.
 - When operating in AMF mode, the machine will automatically stop when the Mains returns.



When the unit is stopped with the STOP button in Automatic operation, it will automatically go to Manual Mode.





- Cooldown period default 15 sec.
- Put the starter switch S20 in position O (OFF) to shut down the voltage supply towards the Qc2002™ module.
- Lock all doors to avoid unauthorized access.



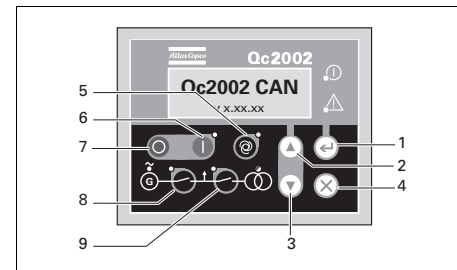

4.3.4 Setting the Qc2002™

4.3.4.1 Push button and LED functions

Following push buttons are used on the Qc2002™:



- 1  **ENTER:** Is used to select and confirm changed settings in the Parameter list.
- 2  **UP:** Is used to scroll through the display information and to adjust parameter value upwards.
- 3  **DOWN:** Is used to scroll through the display information and to adjust parameter value downwards.
- 4  **BACK:** Is used to leave the Alarm pop-up window, to leave the Parameter list and to leave menu's without change.

- 5  **AUTOMATIC:** Is used to put the unit in manual or automatic operation.
- 6  **START:** Is used to start the unit in manual operation.
- 7  **STOP:** Is used to stop the unit in manual or automatic operation (without cooldown). When the unit is stopped with the STOP button in automatic operation, it will automatically go to manual operation.
- 8  **GENERATOR CONTACTOR:** Is used to open or close the Generator contactor, if the Qc2002™ is in manual operation
- 9  **MAINS CONTACTOR:** Is used to open or close the Mains contactor, if the Qc2002™ is in manual operation.

Following LEDs are used on the Qc2002™:

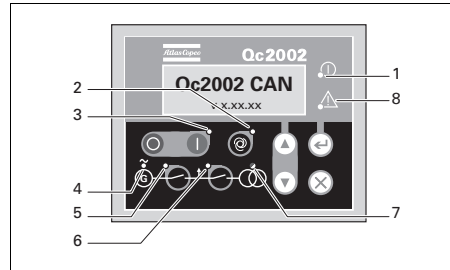

- | | | | | | |
|---|----------------------------|---|---|------------------------|---|
| 1 | Power | Green LED indicates that the unit is powered up. | 6 | Mains contactor | Green LED indicates that it is possible to close the Mains Contactor (only in AMF mode), if the Generator contactor is open. |
| 2 | Automatic | Green LED indicates that the Qc2002™ is in automatic operation. | 7 | Mains voltage | LED is green, if the mains is present and OK.
LED is red when a mains failure is detected.
LED is flashing green when the mains returns during the 'mains OK delay' time. |
| 3 | Start/Stop | Green LED indicates that the Qc2002™ receives running feedback (via the W/L input, via the RPM value at the Canbus, or via the AC frequency). | 8 | Alarm | Flashing red LED indicates that an alarm is present. A continuous red LED indicates that the alarm has been acknowledged by the user. The exact alarm is shown on the display. |
| 4 | U/F OK | Green LED indicates that the voltage/frequency is present and OK. | | | |
| 5 | Generator contactor | Green LED indicates that the voltage and the frequency of the alternator are within certain limits for a certain time. It will be possible to close the Generator Contactor (both in Island and in AMF mode), if the Mains contactor is open. | | | |

4.3.4.2 Qc2002™ menu overview

At Qc2002™, the LCD will show following information:

- in **Normal** condition (scroll through the information using **UP** and **DOWN**):
 - Status (e.g.: preheat, crank, cooldown, extended stop time, ...)
 - Line voltages of the generator
 - Controller type & version
 - Parameter list
 - Alarm list
 - LOG list
 - Service Timer 1 & Service Timer 2
 - Battery Voltage
 - RPM (speed)
 - Coolant temperature
 - Oil pressure
 - Fuel level
 - kWh counter
 - Power factor, the frequency of the generator and the frequency of the mains
 - Line voltage, frequency and active power of the generator

- Active, reactive and apparent power of the generator
- Generator currents
- Phase voltages of the mains
- Line voltages of the mains
- Phase voltages of the generator
- in **Alarm** condition (scroll through the information using **UP** and **DOWN**):
 - a list of all active Alarms

It's possible to scroll through the views, using the **UP** and **DOWN** buttons. The scrolling is continuous.

If a Special status occurs, the Status Display is shown.
If an Alarm occurs, the Alarm Display is shown.

4.3.4.3 Qc2002™ menu description

Status Display (pop-up window)

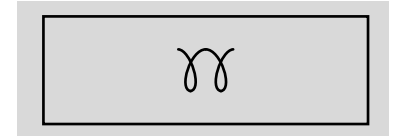

In case special statuses are entered, a pop-up window will automatically be entered for as long as the status is active.

The background screen is not updated when the status pop-up window is active.

These special statuses are:

PREHEAT



START OFF/
EXTENDED
STOP TIMER



COOLDOWN



DIAGNOSTIC

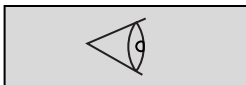

If a special status has elapsed, the active view will be entered again automatically.

If an Alarm occurs, the Alarm Display is shown.

Line voltages generator display

G L1-L2	400V
G L2-L3	400V
G L3-L1	400V

This view shows the line voltages of the generator.

Controller type and version display

Qc2002 CAN
V X.XX.XX

This view shows the controller type and the ASW version number.

Parameter display

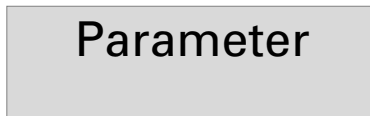

This view shows a number of Parameter settings and gives access to them.

An overview is given in “Parameter list” on page 43.

Alarm list display

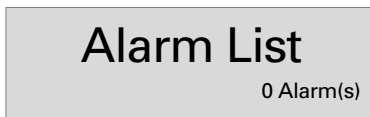

This view shows the number of active alarms and gives access to them.

An overview is given in “Alarm overview” on page 107.

LOG list display



This view shows the alarm memory and gives access to it.

An overview is given in “LOG list” on page 48.

Service timer 1 & Service timer 2 display

Service 1	59h
Service 2	59h

This view shows both Service timers. The service timer indication is shown when service time has run out. It can be removed by resetting the timers or acknowledging the Service timer indication.

The service timer indications count and give an alarm when value is reached.

Resetting the Service Timers can be done through the Parameter display.

Battery voltage display

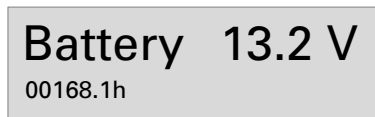

This view shows the Battery voltage and the running hours.

RPM display

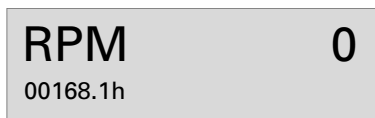

This view shows the engine speed and the running hours.

Coolant temperature display

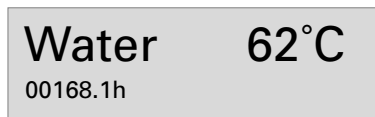

This view shows the Coolant temperature and the running hours.

See also “Parameter list” on page 43 for selection between °C and °F.

Oil pressure display

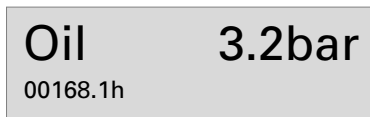

This view shows the Oil pressure and the running hours.

See also “Parameter list” on page 43 for selection between bar and psi.

Fuel level display

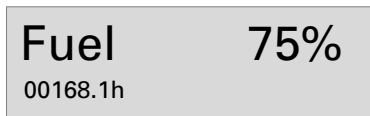

This view shows the Fuel level and the running hours.

kWh counter display

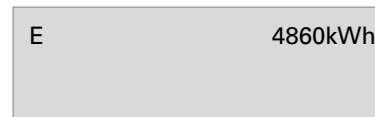

This view shows the kWh counter.

Power factor - frequency generator - frequency mains display

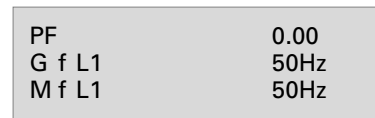

This view shows the PF, the frequency of the generator and the frequency of the mains (M f L1: only in AMF mode).

One line voltage - frequency - active power display

G L1-L2	400V
G f L1	50Hz
P	80kW

This view shows one line voltage, frequency and active power of the generator.

Active - reactive - apparent power display

P	80kW
Q	0kVAr
S	80kVA

This view shows the active, reactive and apparent power of the generator.

Generator current display

G I1	100A
G I2	100A
G I3	100A

This view shows the generator current.

Phase voltages mains display

M L1-N	230V
M L2-N	230V
M L3-N	230V

This view shows the phase voltages of the mains (is only shown in AMF mode).

Line voltages mains display

M L1-L2	400V
M L2-L3	400V
M L3-L1	400V

This view shows the line voltages of the mains (is only shown in AMF mode).

Phase voltages generator display

G L1-N	230V
G L2-N	230V
G L3-N	230V

This view shows the phase voltages of the generator.

4.3.4.4 Parameter list

The parameter menu's are pre-programmed!

A password will be asked for when an attempt to change a setting is about to be done (user password = 2003).

By entering the parameter list, push button AUTOMATIC is disposed of its normal operations and will not perform any functionality.

It's possible to scroll between configuration menu's by using the push buttons UP and DOWN.

Pushing the ENTER button activates the configuration menu which is shown at the display.

Menu's shown on the parameter list LCD:

Genset mode

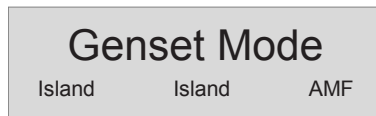

This menu is used to change the mode of the machine. In the Qc2002™ module 2 application modes can be selected:

Island operation

- This operation type is selected for local/remote start applications, without the Mains (= stand-alone).
 - Combined with Manual Operation mode = Local Start operation.
 - The sequences start / stop / close Generator Contactor / open Generator Contactor can be activated manually.
 - Combined with Automatic Operation mode = Remote Start operation.
- The remote start signal can be given with an external switch. After the generator has been started, the Generator Contactor will close automatically.
- Installation wiring for Remote Start operation: wire the RS switch between X25.9 & X25.10.

Automatic Mains Failure (AMF) operation



This application is only possible in combination with the AUTO mode. If the Manual Operation mode is selected the AMF operation will NOT function!

- When the Mains exceeds the defined voltage / frequency limits for a defined delay time, the generator will take over the load automatically.
- When the mains is restored within the defined limits for a defined time, the generator will unload before disconnecting and switching back to the Mains.
- The generator will then go into cooldown and stop. It will stay stand-by for the next event.
- Installation wiring for Remote Start operation: refer to circuit diagram 9822 0996 16/02 for the correct connections.



To operate the unit in AMF mode, make sure that the COC (Change Over Contactors) box is properly installed, see page 129.

Horn delay

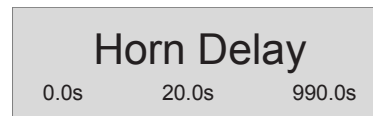

This menu is used to set the delay, how long the general alarm relay stays energized (if present). If set to 0.0s, the general alarm relay will stay energized continuously.

Running hours adjust

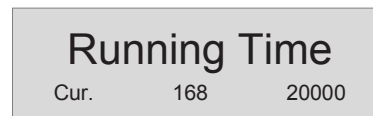

This menu is used to adjust the amount of running hours. The running hours can only be increased, not decreased.

Service timer 2 reset

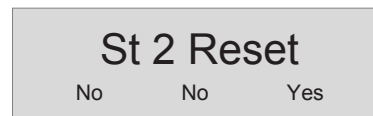

Service timer 1 reset

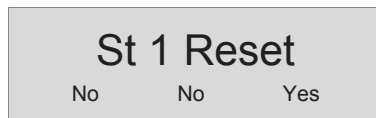

These menus are used to reset the service timers. When a service timer alarm occurs and is acknowledged, the service timer will be reset automatically.

Diagnostic menu

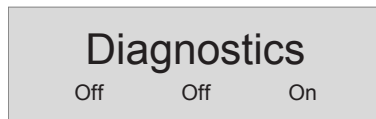

This menu is used to power up the engine electronics without starting the engine. When this setting is switched on, electric power will be supplied to the engine electronics after half a minute delay. The unit can not be started as long as this parameter is switched on.

Unit menu



This menu is used to select the units into which pressures and temperatures will be shown.

Language selection

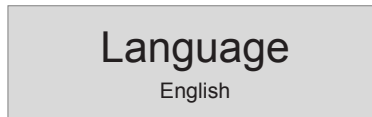

Icons is the default factory set language, but 6 other languages can be selected: English, French, German, Italian, Spanish and Cyrillic (Russian). All information in the Parameter List display is always in English.

Engine CAN communication

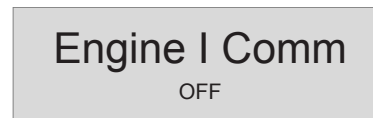

This menu is used to select the type of engine electronics, the Qc2002™ controller should communicate with via the Canbus.

MF high frequency

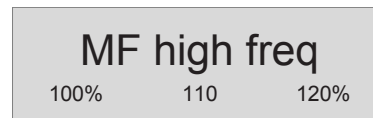

This menu is used to set the maximum limit for the mains frequency, in % of the nominal frequency (in AMF-Auto).

MF low frequency

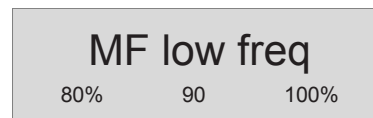

This menu is used to set the minimum limit for the mains frequency, in % of the nominal frequency (in AMF-Auto).

M frequency delay



This menu is used to set the delay, which defines how long the mains frequency has to be back within the limits before there will be switched from generator to mains again (in AMF-Auto). During this delay, the Mains LED flashes in green.

MF frequency delay



This menu is used to set the delay, which defines how long the mains frequency may be above the max limit or below the min limit before there will be switched from mains to generator (in AMF-Auto). During this delay, the Mains LED flashes in red.

MF high voltage



This menu is used to set the maximum limit for the mains voltage, in % of the nominal voltage (in AMF-Auto).

MF low voltage

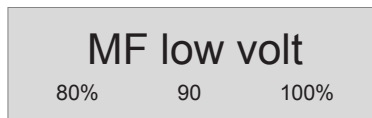

This menu is used to set the minimum limit for the mains voltage, in % of the nominal voltage (in AMF-Auto).

M voltage delay



This menu is used to set the delay, which defines how long the mains voltage has to be back within the limits before there will be switched from generator to mains again (in AMF-Auto). During this delay, the Mains LED flashes in green.

MF voltage delay



This menu is used to set the delay, which defines how long the mains voltage may be above the max limit or below the min limit before there will be switched from mains to generator (in AMF-Auto). During this delay, the Mains LED flashes in red.

Overvoltage enable

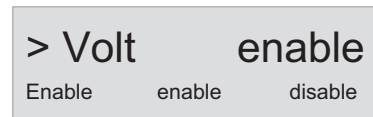

Overvoltage fail class



Overvoltage delay

> Volt Delay
0 1 99

Overvoltage setpoint

> Volt SP
0 450 999

Undervoltage enable

< Volt enable
Enable enable disable

Undervoltage fail class

< Volt FC
warning warning shutdown

Undervoltage delay

< Volt Delay
0 1 99

Undervoltage setpoint

< Volt SP
0 450 999

Overfrequency enable

> Freq enable
Enable enable disable

Overfrequency fail class

> Freq FC
warning warning shutdown

Overfrequency delay

> Freq Delay
0 1 99

Overfrequency setpoint

> Freq SP
0 38 70

Underfrequency enable

< Freq enable
Enable enable disable

Underfrequency fail class

< Freq FC
warning warning shutdown

Underfrequency delay

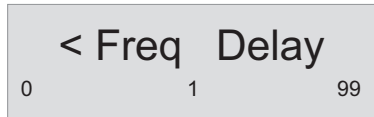

Underfrequency setpoint

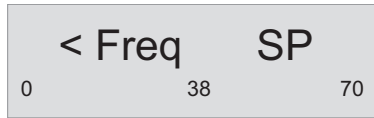

4.3.4.5 LOG list

The unit will keep an event log of the latest 30 events.

Events are:

- shutdowns
- service timer 1/2 reset

Together with each event, the real time of the event will be stored.

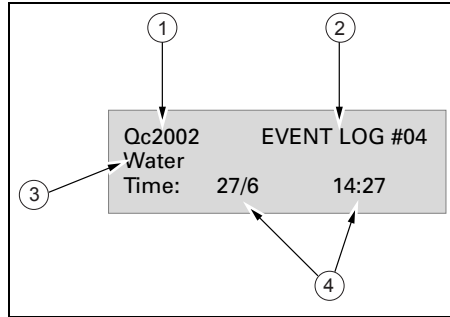

- | | | |
|---|--|----------------------------|
| 1 | | Controller type |
| 2 | | Event number |
| 3 | | Event |
| 4 | | Date and hour of the event |

4.4 Operating and setting Qc1103™

4.4.1 Starting

- Switch on the battery switch, if applicable.
- Turn starter switch S20 to position I (ON) to power up the Qc1103™ controller.
- Switch off circuit breaker Q1.
- Select the desired operating mode on the Qc1103™ controller (see chapter “Running modes” on page 56 for the possible selections).
- To start-up the generator in MANUAL mode:
 - Press the **MAN** push button on the Qc1103™ controller to activate MANUAL mode.
 - Use the **START** button to start-up the generator.
 - The unit will start.
In cold conditions the unit might not start from the first attempt. The controller will make 3 start attempts.
 - Allow the generator to start-up till voltage and frequency are OK (**Hz/V ok** lights up).
 - Switch on circuit breaker Q1.
- To start-up the generator in AUTO mode:
 - Press the **AUTO** push button on the Qc1103™ controller to activate AUTO mode.
 - Switch on circuit breaker Q1.

- The unit will start automatically at a start command (e.g. a remote start signal or set timer).
In cold conditions the unit might not start from the first attempt. The controller will take 3 start attempts.

4.4.2 During operation

Regularly carry out following checks:

- Check the controller display for normal readings.



Avoid to let the engine run out of fuel. If it happened, priming will speed up the starting.

- Check for leakage of oil, fuel or coolant.



Avoid long low-load periods (< 30%). In this case, an output drop and higher oil consumption of the engine could occur. Refer to chapter “Preventing low loads”.

- Check that the voltage between the phases is identical and that the rated current is not exceeded.
- When single-phase loads are connected to the generator output terminals, keep all loads well-balanced.
- If circuit breakers have tripped during operation, switch off the load and stop the generator. Check and, if necessary, decrease the load.



The generator’s doors may only remain opened for short periods during operation, to carry out checks for example.

4.4.3 Stopping



- When in MANUAL mode:
 - Switch off the load.
 - Switch off circuit breaker Q1.
 - Press the **STOP** button to stop the generator immediately after cooldown.
- When in AUTO mode:
 - Switch off the load.
 - The engine will stop when a stop command (e.g. a remote start/stop signal or set timer) is given.
- Turn starter switch S20 in position O (OFF) to shut down the voltage supply towards the Qc1103™ controller.
- Lock all doors to avoid unauthorized access.





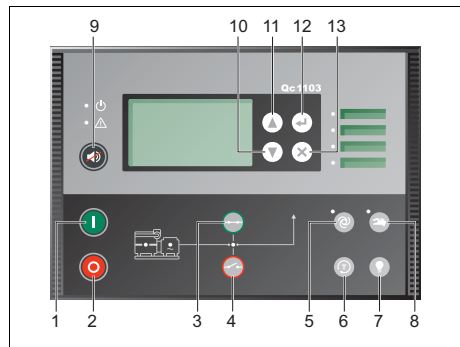

4.4.4 Setting the Qc1103™





4.4.4.1 Push button and LED functions

Following push buttons are used on the Qc1103™:



- 1  **START:** Is used to start the engine (manual running mode).
- 2  **STOP:** Is used to stop the engine (manual running mode).
- 3  **CLOSE GB:** Is used to close the generator breaker manually (only in manual running mode).

- 4  **OPEN GB:** Is used to open the generator breaker manually (only in manual running mode).
- 5  **AUTO:** Is used to put the generator in AUTO running mode.
- 6  **TEST:** Is used to put the generator in TEST running mode.
- 7  **LAMP TEST:** Is used to perform a lamp test.
- 8  **MAN:** Is used to put the generator in MANUAL/BLOCK running mode.
Press MAN **once** to activate MANUAL mode, press MAN **twice** to activate BLOCK mode.
- 9  **RESET HORN:** Is used to reset the horn relay.
Press and hold the RESET HORN button for 2 seconds to enter the alarm list.

- 10  **UP:** Is used to scroll upwards through the display information and to increase a parameter value.
- 11  **DOWN:** Is used to scroll downwards through the display information and to decrease a parameter value.
- 12  **ENTER:** Is used to enter menus and values and to acknowledge alarms.
- 13  **BACK:** Is used to leave menu's without change and to remove pop-up messages.

Following LEDs are used on the Qc1103™:

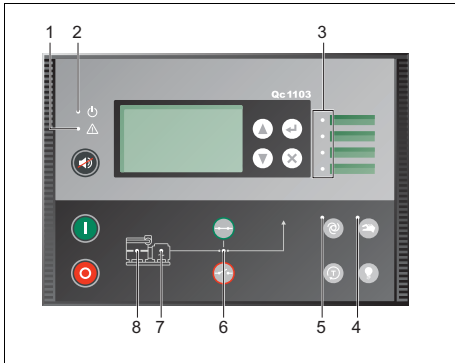

1 Alarm	LED flashing indicates that unacknowledged alarms are present. LED steady indicates that all alarms are acknowledged, but some are still present.
2 Power	LED indicates that the auxiliary supply is switched on. Green LED indicates that the controller is operational. Red LED indicates that the self-check has failed.
3 User configurable indicators	4 LEDs with selectable indication function. Selection is made using PARUS software.

4 MAN	LED steady indicates that MANUAL mode is active. LED flashing green indicates that BLOCK mode is active.
5 AUTO	LED indicates that AUTO mode is active.
6 GB on	LED indicates that the generator breaker is closed.
7 Hz/V ok	LED indicates that voltage and frequency are present and OK.
8 Run	LED indicates that running feedback is present.

4.4.4.2 Qc1103™ menu overview

The Qc1103™ display includes the menu systems listed below which can be used/viewed without password entry:

– View menu:

The view menus are the daily use menus for the operator. There are 20 configurable display views, with up to three configurable display lines in each view. View configuration is done through PARUS software.

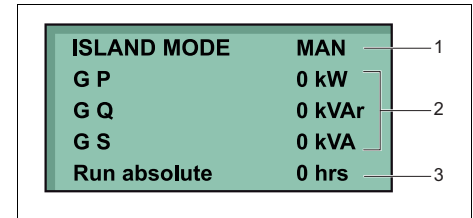

- 1** | Genset mode and running mode
- 2** | Measurements relating to operational status
- 3** | Running hours

- Log menu:

This menu contains event, alarm and battery logs.

- Setup menu:

This menu is used for setting up the unit, and if the operator needs detailed information that is not available in the view menu system.

Changing of parameter settings is password-protected.

- Alarm list:

This list shows active acknowledged and unacknowledged alarms. Alarms can be acknowledged by pressing the **ENTER** button.

- Service menu:

This menu contains input-, output, M-Logic status and data about the unit.

It is possible to toggle between the menus, using the **UP** and **DOWN** buttons.

View examples:

The software version can be found in the Service menu:

Service menu	
Appl. Ver.:	9.90.0
Appl. Rev.:	0
Boot Ver.:	9.99.1
Boot Rev.:	0

Status, Generator P, Q and S. Run hours:

ISLAND MODE	MAN
G P	0 kW
G Q	0 kVAr
G S	0 kVA
Run absolute	0 hrs

Service timer 1 and 2. Run hours:

ISLAND MODE	MAN
Serv1	1 d 0 h
Serv2	1 d 0 h
Run absolute	0 hrs

Menu flow:

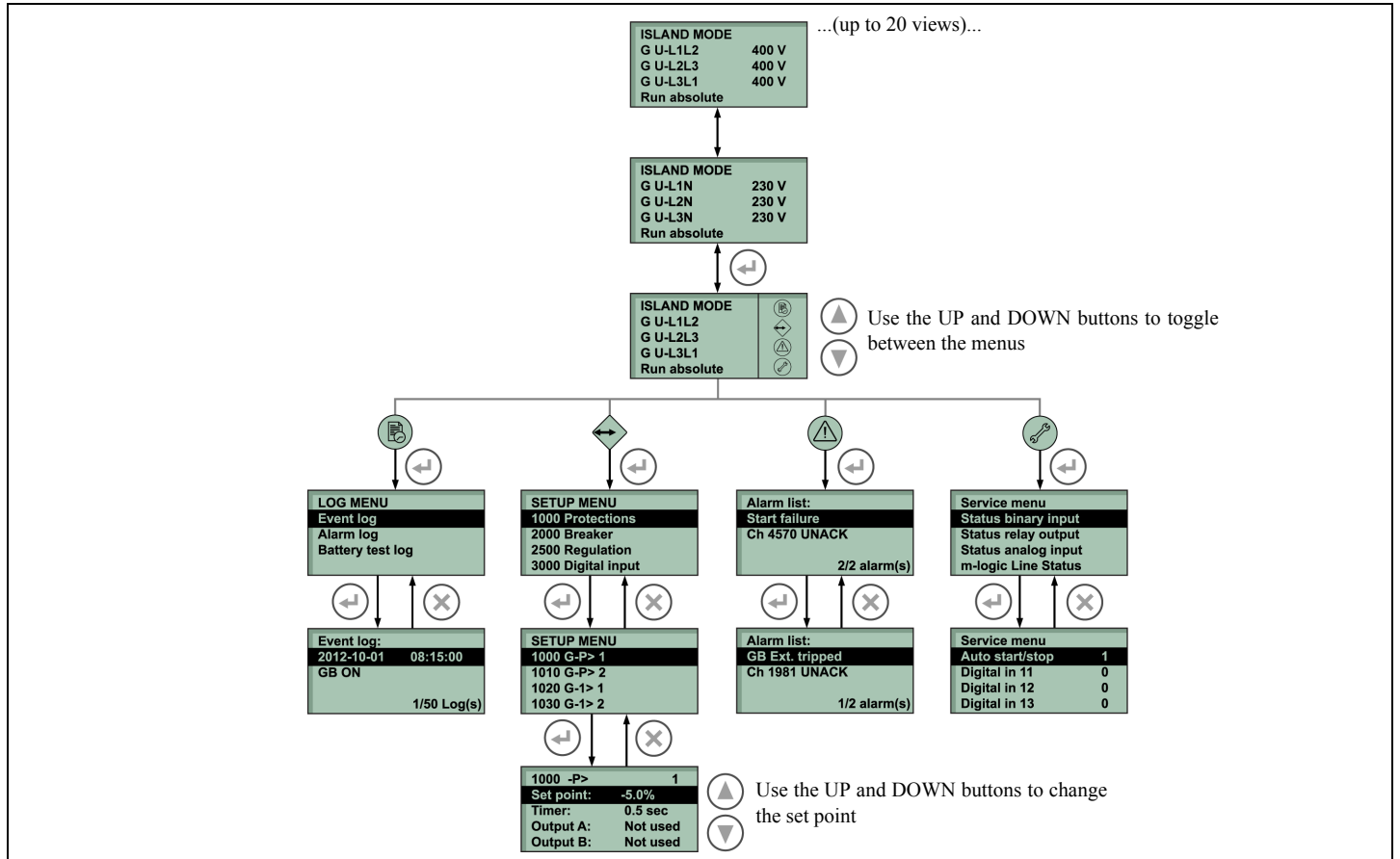

Status line text

Display	Description
BLOCK	Block mode is activated
SIMPLE TEST	Test mode is activated
FULL TEST	
SIMPLE TEST ###.#min	Test mode activated and test timer counting down
FULL TEST ###.#min	
ISLAND MAN	Genset stopped or running and no other action taking place
READY ISLAND AUTO	Genset stopped in Auto
ISLAND ACTIVE	Genset running in Auto
DG BLOCKED FOR START	Generator stopped and active alarm(s) on the generator
GB ON BLOCKED	Generator running, GB open and an active "Trip GB"alarm
SHUTDOWN OVERRIDE	The configurable input is active
ACCESS LOCK	The configurable input is activated, and the operator tries to activate one of the blocked keys.
GB TRIP EXTERNALLY	Some external equipment has tripped the breaker. An external trip is logged in the event log.
IDLE RUN	The "Idle run" function is active. The genset will not stop until a timer has expired.
IDLE RUN ###.#min	The timer in the "Idle run" function is active.
Aux. test ##.#V #####s	Battery test activated
START PREPARE	The start prepare relay is activated

Display	Description
START RELAY ON	The start relay is activated
START RELAY OFF	The start relay is deactivated during the start sequence
Hz/V OK IN ###s	The voltage and frequency on the genset is OK. When the timer runs out it is allowed to operate the generator breaker.
COOLING DOWN ###s	Cooling down period is activated.
COOLING DOWN	Cooling down period is activated and infinite. Cooling down timer is set to 0.0 s.
GENSET STOPPING	This info is shown when cooling down has finished.
EXT. STOP TIME ###s	Extended stop time. The unit will stop after a pre-programmed time of x.x s. after having received a stop signal.

4.4.4.3 Running modes

The unit has three different running modes and one block mode. The different running modes are selected via the display or the PARUS software.

AUTO

In AUTO mode, the unit will operate automatically, and the operator cannot initiate any sequences manually.

TEST

When TEST mode is selected, a test sequence will start. In this mode it is possible to perform two types of tests: a Simple test or a Full test. The type of test is selected in parameter 7040.



The test will be interrupted if the mode is changed to either MANUAL or AUTO.

MANUAL

In MANUAL mode the unit will not initiate any sequences automatically. It will only initiate sequences, if external signals are given.

BLOCK

When BLOCK mode is selected, the unit is not able to initiate any sequences, e.g. the start sequence. BLOCK mode must be selected when maintenance work is carried out on the genset.



The genset will shut down if BLOCK mode is selected while the genset is running.

4.4.4.4 Application modes

Island operation

- This operation mode is selected for local/remote start applications, without the Mains (= stand-alone).
- Combined with MANUAL mode = Local Start operation.
 - The sequence is: start / close generator breaker (manually) / genset operation / open generator breaker (manually) / open generator breaker / stop.
- Combined with AUTO mode = Remote Start operation.
 - The remote start signal can be given with an external switch. Before the generator will be started, the generator breaker must be closed.
 - Installation wiring for Remote Start operation: wire the RS switch between X25.1 & X25.2.

4.4.4.5 Parameter settings

The parameter settings are pre-programmed. To change parameter settings, a password is required. Changing different parameters requires different password levels. Some parameters cannot be changed by the end-customer because of safety reasons.

The Qc1103™ provides three different password levels:

- User password
- Service password
- Master password

A parameter cannot be entered with a password that is ranking too low. But the parameter settings can be displayed without password entry.

Consult the Qc1103™ user manual for all customer level parameters, which can be accessed with the user password. In order to receive the default parameters for your unit, please contact Atlas Copco Service staff.

To change a parameter:

1. Enter the Setup menu.

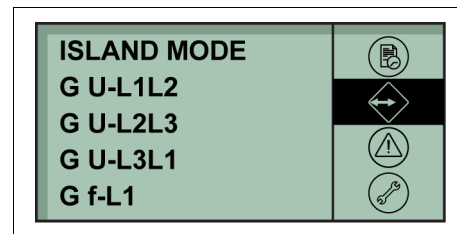

- Press the **ENTER** button to enter the parameter setting.

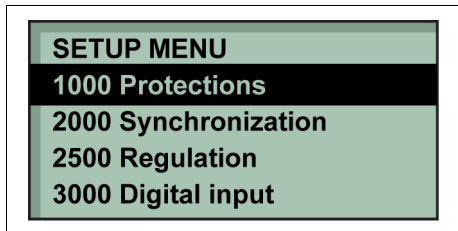

- Select the menu group with the **ENTER** button to edit.

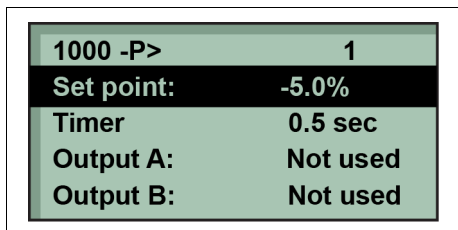

- Enter the password.
- Edit the set point value with the **UP** and **DOWN** buttons and save the value by pressing the **ENTER** button.

4.4.4.6 LOG list

The log is divided into three different lists:

- Event log: contains up to 50 events
- Alarm log: contains up to 30 historical alarm
- Battery test log: contains up to 52 historical battery tests

An event is e.g. closing of breaker and starting of engine. An alarm is e.g. overcurrent or high cooling water temperature. A battery test is e.g. test OK or test failed.

To enter the log list:

- Enter the LOG MENU.
- Select the required log list with the **UP** and **DOWN** push-buttons and select with the **ENTER** button.
- To scroll up and down in the list, use the **UP** and **DOWN** buttons.

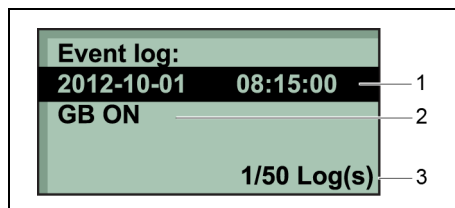

- | | |
|---|----------------------------|
| 1 | Date and time of the event |
| 2 | Event |
| 3 | Event number |

4.5 Operating and setting Qc2103™

4.5.1 Starting

- Switch on the battery switch, if applicable.
- Switch off circuit breaker Q1.
- Turn starter switch S20 to position I (ON) to power up the Qc2103™ controller.
- Select the desired operating mode on the Qc2103™ controller (see chapter “Running modes” on page 56 for the possible selections).
- To start-up the generator in MANUAL mode:
 - Press the **MAN** push button on the Qc2103™ controller to activate MANUAL mode.
 - Use the **START** button to start-up the generator.
 - Allow the generator to start-up till voltage and frequency are OK (**Hz/V ok** lights up).
 - Switch on circuit breaker Q1.
- To start-up the generator in AUTO mode:
 - Press the **AUTO** push button on the Qc2103™ controller to activate AUTO mode.
 - Switch on circuit breaker Q1.
 - Select the desired application mode (see chapter “Application modes” on page 66 for the possible applications).

- The generator will start-up automatically, depending on the selected application:
If in **Island mode**, the generator will start automatically at a start command (e.g. a remote start signal or set timer).
If in **AMF mode**, the generator will automatically start and switch to generator supply at a mains failure after an adjustable delay time.
If in **Load Take Over mode**, the generator will start automatically when a start command is given (e.g. a remote start signal or set timer) and it will switch to generator supply.

4.5.2 During operation

Regularly carry out following checks:

- Check the controller display for normal readings.



Avoid to let the engine run out of fuel. If it happened, priming will speed up the starting.

- Check for leakage of oil, fuel or coolant.



Avoid long low-load periods (<30%). In this case, an output drop and higher oil consumption of the engine could occur. Refer to chapter “Preventing low loads”.

- Check that the voltage between the phases is identical and that the rated current is not exceeded.
- When single-phase loads are connected to the generator output terminals, keep all loads well-balanced.
- If circuit breakers have tripped during operation, switch off the load and stop the generator. Check and, if necessary, decrease the load.



The generator’s doors may only remain opened for short periods during operation, to carry out checks for example.

4.5.3 Stopping



- When in MANUAL mode:
 - Switch off the load.
 - Switch off circuit breaker Q1.
 - Press the STOP button to stop the generator.
- When in AUTO mode:
 - Switch off the load.
 - If in **Island mode**, the generator stops the engine by a stop command (e.g. a remote start/stop signal or set timer).
 - If in **AMF** mode, the unit will switch back to mains supply when the mains returns. Switching back to mains supply is done when the adjusted "Mains OK delay" has expired.
 - If in **Load Take Over** mode, the unit will switch back to mains when a stop command is given (e.g. a remote start/stop signal or set timer).
- After cooldown, the generator will shut down automatically.
- Turn starter switch S20 in position O (OFF) to shut down the voltage supply towards the Qe2103™ controller.
- Lock all doors to avoid unauthorized access





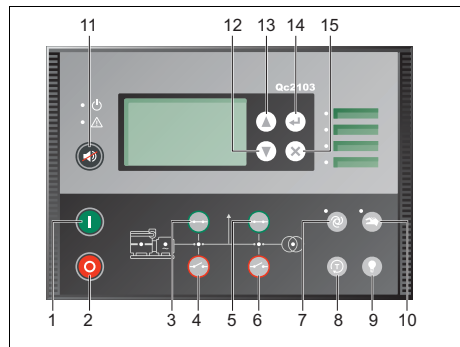

4.5.4 Setting the Qc2103™





4.5.4.1 Push button and LED functions

Following push buttons are used on the Qc2103™:



- 1  **START:** Is used to start the engine (manual running mode).
- 2  **STOP:** Is used to stop the engine (manual running mode).
- 3  **CLOSE MB:** Is used to close the mains breaker manually (only in manual running mode).

- 4  **OPEN MB:** Is used to open the mains breaker manually (only in manual running mode).
- 5  **CLOSE GB:** Is used to close the generator breaker manually (only in manual running mode).
- 6  **OPEN GB:** Is used to open the generator breaker manually (only in manual running mode).
- 7  **AUTO:** Is used to put the generator in AUTO running mode.
- 8  **TEST:** Is used to put the generator in TEST running mode.
- 9  **LAMP TEST:** Is used to perform a lamp test.
- 10  **MAN:** Is used to put the generator in MANUAL/BLOCK running mode. Press MAN **once** to activate MANUAL mode, press MAN **twice** to activate BLOCK mode.

- 11  **RESET HORN:** Is used to reset the horn relay. Press and hold the RESET HORN button for 2 seconds to enter the alarm list.
- 12  **UP:** Is used to scroll upwards through the display information and to increase a parameter value.
- 13  **DOWN:** Is used to scroll downwards through the display information and to decrease a parameter value.
- 14  **ENTER:** Is used to enter menus and values and to acknowledge alarms.
- 15  **BACK:** Is used to leave menu's without change and to remove pop-up messages.

Following LEDs are used on the Qc2103™:

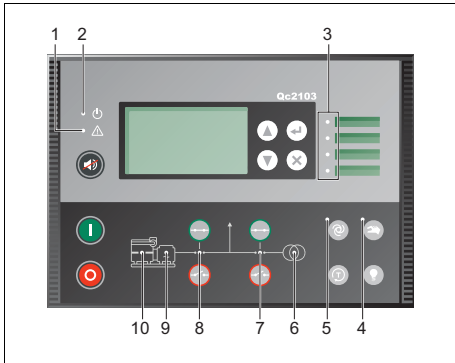

1	Alarm	LED flashing indicates that unacknowledged alarms are present. LED steady indicates that all alarms are acknowledged, but some are still present.
2	Power	LED indicates that the auxiliary supply is switched on. Green LED indicates that the controller is operational. Red LED indicates that the self-check has failed.
3	User configurable indicators	4 LEDs with selectable indication function. Selection is made using PARUS software.

4	MAN	LED steady indicates that MANUAL mode is active. LED flashing green indicates that BLOCK mode is active.
5	AUTO	LED indicates that AUTO mode is active.
6	Mains ok	LED is green if the mains is present and OK. LED is red at a mains failure. LED is flashing green when the mains returns during the "mains OK delay" time.
7	MB on	LED Indicates that the mains breaker is closed.
8	GB on	LED indicates that the generator breaker is closed.
9	Hz/V ok	LED indicates that voltage and frequency are present and OK.
10	Run	LED indicates that running feedback is present.

4.5.4.2 Qc2103™ menu overview

The Qc2103™ display includes the menu systems listed below which can be used/viewed without password entry:

– View menu:

The view menus are the daily use menus for the operator. There are 20 configurable display views, with up to three configurable display lines in each view. View configuration is done through the PARUS software.

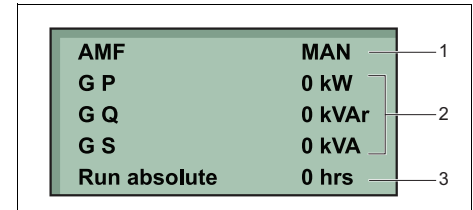

- 1 Genset mode and running mode
- 2 Measurements relating to operational status
- 3 Running hours

- Log menu:
This menu contains event, alarm and battery logs.
- Setup menu:
This menu is used for setting up the unit, and if the operator needs detailed information that is not available in the view menu system.
Changing of parameter settings is password-protected.
- Alarm list:
This list shows active acknowledged and unacknowledged alarms. Alarms can be acknowledged by pressing the **ENTER** button.
- Service menu:
This menu contains input-, output, M-Logic status and data about the unit.

It is possible to toggle between the menus, using the **UP** and **DOWN** buttons.

View examples:

The software version can be found in the Service menu:

Service menu	
Appl. Ver.:	9.90.0
Appl. Rev.:	0
Boot Ver.:	9.99.1
Boot Rev.:	0

Status, Generator P, Q and S. Run hours:

AMF	MAN
G P	0 kW
G Q	0 kVAr
G S	0 kVA
Run absolute	0 hrs

Service timer 1 and 2. Run hours:

AMF	MAN
Serv1	1 d 0 h
Serv2	1 d 0 h
Run absolute	0 hrs

Menu flow:

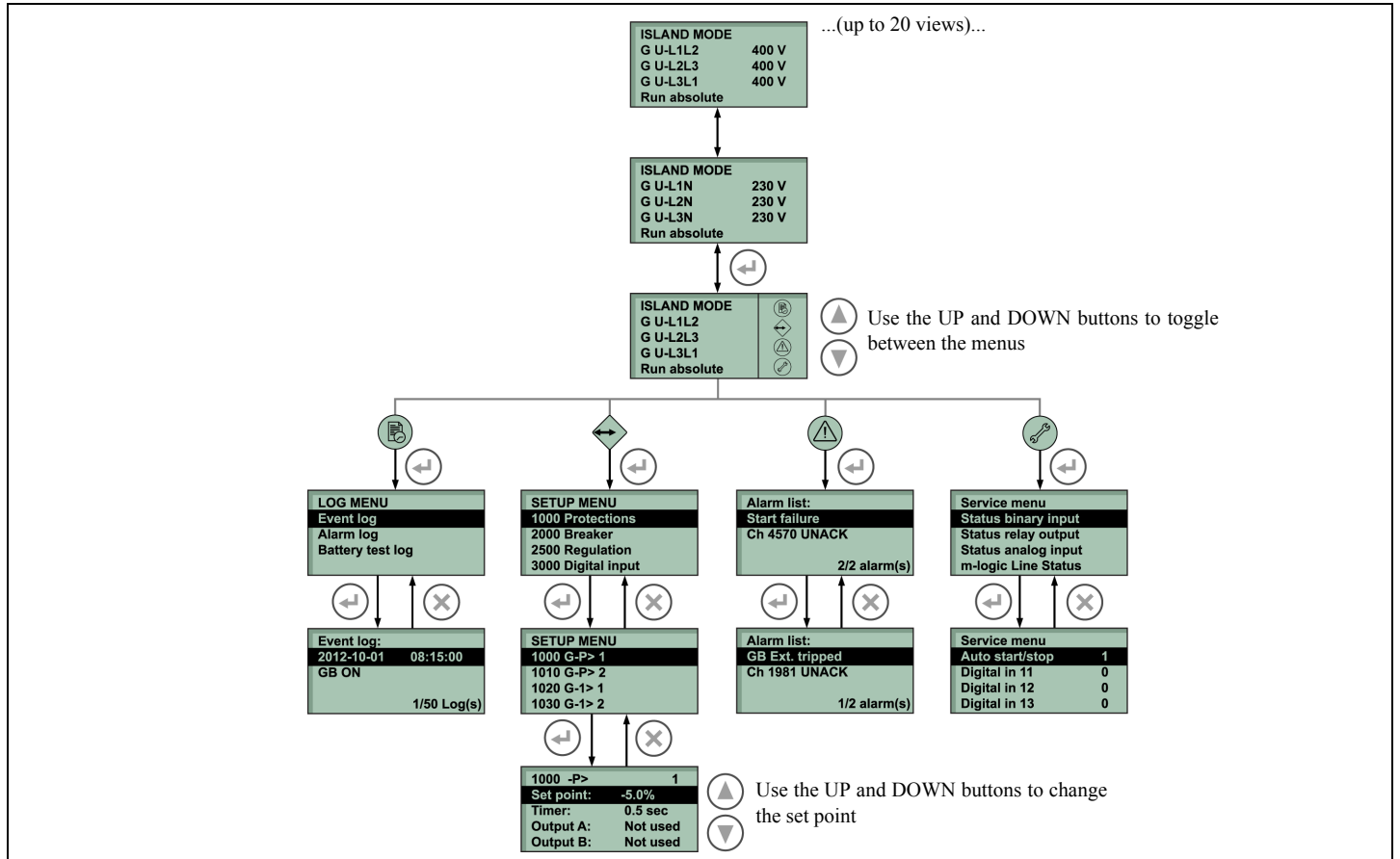

Status line text

Display	Description
BLOCK	Block mode is activated
SIMPLE TEST	Test mode is activated
FULL TEST	
SIMPLE TEST ###.#min	Test mode activated and test timer counting down
FULL TEST ###.#min	
ISLAND MAN	Genset stopped or running and no other action taking place
READY ISLAND AUTO	Genset stopped in Auto
ISLAND ACTIVE	Genset running in Auto
AMF MAN	Genset stopped or running and no other action taking place
READY AMF AUTO	Genset stopped in Auto
AMF ACTIVE	Genset running in Auto
LOAD TAKEOVER MAN	Genset stopped or running and no other action taking place
READY LTO AUTO	Genset stopped in Auto
LTO ACTIVE	Genset running in Auto
DG BLOCKED FOR START	Generator stopped and active alarm(s) on the generator
GB ON BLOCKED	Generator running, GB open and an active "Trip GB"alarm
SHUTDOWN OVERRIDE	The configurable input is active.
ACCESS LOCK	The configurable input is activated, and the operator tries to activate one of the blocked keys.
GB TRIP EXTERNALLY	Some external equipment has tripped the breaker. An external trip is logged in the event log.
MB TRIP EXTERNALLY	Some external equipment has tripped the breaker. An external trip is logged in the event log.
IDLE RUN	The "Idle run" function is active. The genset will not stop until a timer has expired.
IDLE RUN ###.#min	The timer in the "Idle run" function is active.

Display	Description
Aux. test ##.#V #####s	Battery test activated
START PREPARE	The start prepare relay is activated.
START RELAY ON	The start relay is activated.
START RELAY OFF	The start relay is deactivated during the start sequence.
MAINS FAILURE	Mains failure and mains failure timer expired.
MAINS FAILURE IN ####s	Frequency or voltage measurement is outside the limits. The timer shown is the Mains failure delay. Text in mains units.
MAINS U OK DEL #####s	Mains voltage is OK after a mains failure. The timer shown is the Mains OK delay.
MAINS f OK DEL #####s	Mains frequency is OK after a mains failure. The timer shown is the Mains OK delay.
Hz/V OK IN ####s	The voltage and frequency on the genset is OK. When the timer runs out it is allowed to operate the generator breaker.
COOLING DOWN ####s	Cooling down period is activated.
COOLING DOWN	Cooling down period is activated and infinite. Cooling down timer is set to 0.0 s.
GENSET STOPPING	This info is shown when cooling down has finished.
EXT. STOP TIME ####s	Extended stop time. The unit will stop after a pre-programmed time of x.x s. after having received a stop signal.
EXT. START ORDER	A planned AMF sequence is activated. There is no failure on the mains during this sequence.

4.5.4.3 Running modes

The unit has three different running modes and one block mode. The different running modes are selected via the display or the PARUS software.

Auto

In AUTO mode, the unit will operate automatically, and the operator cannot initiate any sequences manually.

Test

When TEST mode is selected, a test sequence will start. In this mode it is possible to perform two types of tests: a Simple test or a Full test. The type of test is selected in parameter 7040.



The test will be interrupted if the mode is changed to either MANUAL or AUTO.

Manual

In MANUAL mode the unit will not initiate any sequences automatically. It will only initiate sequences, if external signals are given.

Block

When BLOCK mode is selected, the unit is not able to initiate any sequences, e.g. the start sequence. BLOCK mode must be selected when maintenance work is carried out on the genset.



The genset will shut down if BLOCK mode is selected while the genset is running.

4.5.4.4 Application modes

Island operation

- This operation mode is selected for local/remote start applications, without the Mains (= stand-alone).
- Combined with MANUAL mode = Local Start operation.
 - The sequence is: start / close generator breaker (manually) / genset operation / open generator breaker (manually) / open generator breaker / stop.
- Combined with AUTO mode = Remote Start operation.
 - The remote start signal can be given with an external switch. Before the generator will be started, the generator breaker must be closed.
 - Installation wiring for Remote Start operation: wire the RS switch between X25.R1 & X25.R2.

Automatic Mains Failure (AMF) operation



This application is only possible in combination with the AUTO mode. If the MANUAL mode is selected the AMF operation will NOT function!

- When the Mains exceeds the defined voltage / frequency limits for a defined delay time, the generator will take over the load automatically.

- When the mains is restored within the defined limits for a defined time, the generator will unload before disconnecting and switching back to the Mains.
- The generator will then go into cooldown and stop. It will stay stand-by for the next event.
- Installation wiring for Remote Start operation: refer to circuit diagram 1636 0052 40/00 for the correct connections.



To operate the unit in AMF mode, make sure that the PTB (Power Transfer Box) is properly installed, see page 129.

Load Take Over (LTO) operation

- This operation mode is selected for local/remote start applications.
- Combined with MANUAL mode = Local Start operation.
 - The sequence is: start / open mains breaker contactor / close generator breaker contactor / genset operation / open generator breaker contactor / close mains breaker contactor / stop.

- Combined with AUTO mode = Remote Start operation.
 - The remote start signal can be given with an external switch. After the generator has been started, the mains breaker will open automatically and the generator breaker will close. When the start signal is removed the generator breaker will open automatically and the mains breaker will close.
 - The generator will then go into cooldown and stop.
 - Installation wiring for Remote Start operation: wire the RS switch between X25.R1 & X25.R2.



To operate the unit in LTO mode, make sure that the PTB (Power Transfer Box) is properly installed, see page 129.

4.5.4.5 Parameter settings

The Parameter menu's are pre-programmed.

To change parameter settings, a password is required.

Changing different parameters requires different password levels. Some parameters cannot be changed by the end-customer because of safety reasons.

The Qc2103™ provides three different password levels:

- User password
- Service password
- Master password

A parameter cannot be entered with a password that is ranking too low. But the parameter settings can be displayed without password entry.

Consult the Qc2103™ user manual for all customer level parameters, which can be accessed with the user password. In order to receive the default parameters for your unit, please contact Atlas Copco Service staff.

To change a parameter:

1. Enter the Setup menu.

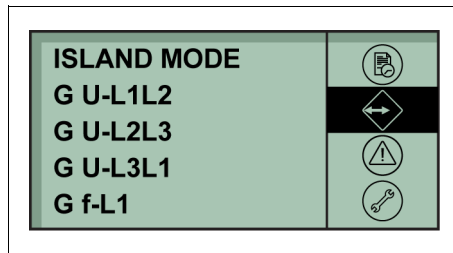

2. Press the **ENTER** button to enter the parameter setting.

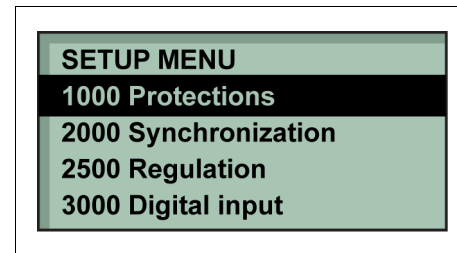

3. Select the menu group with the **ENTER** button to edit.

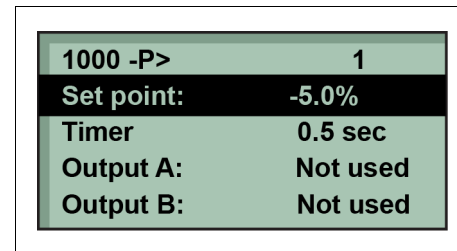

4. Enter the password.
5. Edit the set point value with the **UP** and **DOWN** buttons and save the value by pressing the **ENTER** button.

4.5.4.6 LOG list

The log is divided into three different lists:

- Event log: contains up to 50 events
- Alarm log: contains up to 30 historical alarm
- Battery test log: contains up to 52 historical battery tests

An event is e.g. closing of breaker and starting of engine. An alarm is e.g. overcurrent or high cooling water temperature. A battery test is e.g. test OK or test failed.

To enter the log list:

1. Enter the LOG MENU.
2. Select the required log list with the **UP** and **DOWN** push-buttons and select with the **ENTER** button.
3. To scroll up and down in the list, use the **UP** and **DOWN** buttons.

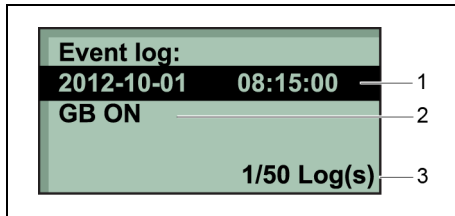

- | | |
|---|----------------------------|
| 1 | Date and time of the event |
| 2 | Event |
| 3 | Event number |

4.6 Operating and setting Qc4002™ MkII



Before setting the controller make sure that the Qc4002™ MkII is **NOT** in AUTO mode. This will prevent the unit to start up automatically without prior notice. Also, in AUTO mode some parameters are unavailable.

4.6.1 Starting

- Turn the battery switch to ON.
- Turn the S20 button to the ON position to activate the Qc4002™ MkII controller.
- Select the correct application type and the correct mode on the Qc4002™ MkII module (see “Overview of applications” on page 84 for the possible selections).
- Make the correct wiring and program the applicable parameters (see “Standard applications” on page 77 for more details).
- When in SEMI-AUTO mode:
 - Use the START button to start-up the generator.
 - Allow the generator to start-up till voltage and frequency are OK (LED U/F OK lights up).
 - Press the GB open/close button to close the generator breaker.
- When in AUTO mode:
 - The generator will start-up automatically and close the contactors depending on the selected application.

4.6.2 During operation

Regularly carry out following checks:

- Check the display for normal readings.



Avoid letting the engine run out of fuel. If this happens, priming will speed up the starting.

- Check for leakage of oil, fuel or cooling water.



Avoid long low-load periods (< 30%). In this case, an output power drop and higher oil consumption of the engine could occur. Refer to ‘Preventing low loads’.

- When single-phase loads are connected to the generator output terminals, keep all loads well-balanced.
- If circuit breakers have tripped during operation, switch off the load and stop the generator. Check and, if necessary, decrease the load.



Never turn the battery switch to OFF during operation.



The generator’s doors may only remain opened for short periods during operation, to carry out checks for example.

4.6.3 Stopping

- When in SEMI-AUTO mode:
 - Press the GB open/close button to open the generator breaker.
 - Press the STOP button **once** to stop the generator. The unit will go into cooldown and stop after the cooldown period.
 - Press the STOP button **twice** to stop the generator immediately, without going into cooldown.



Not allowing the unit to cooldown properly can lead to severe damage to the engine!



- When in AUTO mode:
 - The generator shuts down automatically depending on the selected application.
 - If you want to stop the generator manually, go first to SEMI-AUTO mode and follow the procedure for stopping in SEMI-AUTO mode.





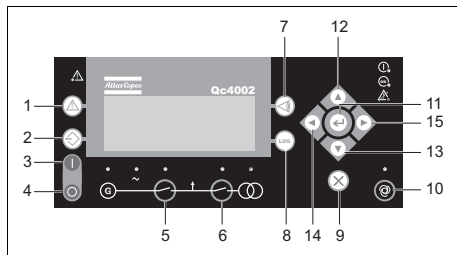

4.6.4 Setting the Qc4002™ MkII





4.6.4.1 Push button and LED functions

Following push buttons are used on the Qc4002™ MkII



- 1  **INFO:** Shifts the display 3 lower lines to show the alarm list.
- 2  **JUMP:** Enters a specific menu number selection. All settings have a specific number attached to them. The JUMP button enables the user to select and display any setting without having to navigate through the menus.
- 3  **START:** Start of the genset if SEMI-AUTO or MANUAL is selected.

- 4  **STOP:** Stop of the genset if SEMI-AUTO or MANUAL is selected.
- 5  **GB:** Manual activation of close breaker and open breaker sequence if SEMI-AUTO is selected.
- 6  **MB:** Manual activation of close breaker and open breaker sequence if SEMI-AUTO is selected.
- 7  **VIEW:** Shifts the first line displaying in the setup menus.
- 8  **LOG:** Displays the LOG SETUP window where you can choose between the Event, Alarm and Battery logs. The logs are not deleted when the auxiliary supply is switched off.
- 9  **BACK:** Jumps one step backwards in the menu (to previous display or to the entry window).
- 10  **MODE:** Changes the menu line (line 4) in the display to mode selection.

- 11  **SEL:** Is used to select the underscored entry in the fourth line of the display.
- 12  **UP:** Increases the value of the selected set point (in the setup menu). In the daily use display, this button function is used for scrolling the View lines in V1 or the second line (in the setup menu) displaying of generator values.
- 13  **DOWN:** Decreases the value of the selected set point (in the setup menu). In the daily use display, this button function is used for scrolling the View lines in V1 or the second line (in the setup menu) displaying of generator values.
- 14  **LEFT:** Moves the cursor left for manoeuvring in the menus.
- 15  **RIGHT:** Moves the cursor right for manoeuvring in the menus.

Following LEDs are used on the Qc4002™ MkII

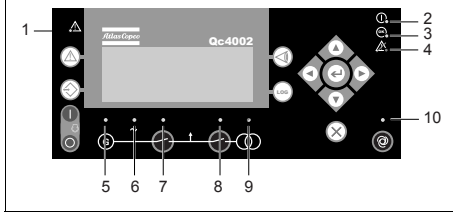

1	Alarm	LED flashing indicates that unacknowledged alarms are present. LED fixed light indicates that ALL alarms are acknowledged.
2	Power	LED indicates that the auxiliary supply is switched on.
3	Self check OK	LED indicates that the self check is OK.
4	Alarm inhibit	LED indicates that one of the alarm inhibit functions is active. LED switches off automatically. No action should be taken.
5	Run	LED indicates that the generator is running.
6	U/F OK	LED green light indicates that the voltage/frequency is present and OK.

7	(GB) ON	LED green light indicates that the generator breaker is closed. LED yellow light indicates that the generator breaker has received a command to close on a black BUS, but the breaker is not yet closed due to interlocking of the GB. LED is flashing orange if the 'Spring load time' signal from the breaker is missing.
8	(MB) ON	LED indicates that the mains breaker is closed.
9	Mains voltage	LED is green, if the mains is present and OK. LED is red when a mains failure is detected. LED is flashing green when the mains returns during the 'mains OK delay' time.
10	Auto	LED indicates that auto mode is selected.

The main Qc4002™ MkII control unit includes 5 LEDs

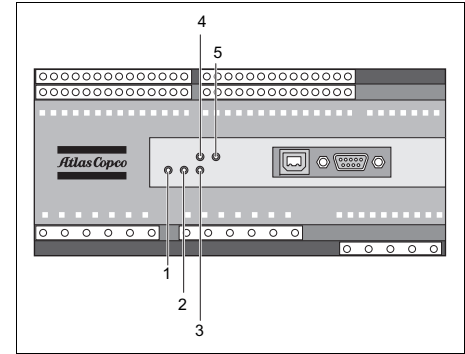

1	Power	Green LED indicates that the voltage supply is switched on.
2	Self check OK	Green LED indicates that the unit is OK.
3	Alarm inhibit	Green LED indicates that the inhibit input is ON.
4	CAN 2	
5	CAN 1	

4.6.4.2 Qc4002™ MkII menu overview

Main View

The display has 4 different lines. The information on these lines can change, depending on which view is used. There are 4 different main views possible: SETUP / V3 / V2 / V1.

Setup view

```
QC4002      V.1.00.0
2002-11-21  16:08:11
SETUP MENU
SETUP     V3  V2  V1
```

V3 view

```
Island      SEMI_AUTO
G  0,001 PF    0kW
G           0kVA  0 kvar
SETUP      V3  V2  V1
```

V2 view

```
G           0      00A
G  0,001 PF    0kW
G           0kVA  0 kvar
SETUP      V3  V2  V1
```

V1 view

```
Run Time 0Hour
Fuel Level 100%
2002-11-21 16:08:11
SETUP      V3  V2  V1
```

The user can scroll through these views with the scroll buttons:

- The SETUP view shows the module name, the software version, the date and the time.
- The V3 view shows the application type and the mode, and some generator measurements. During synchronisation the V3 view will show a synchronoscope in the first line.

- The V2 view shows some generator measurements.
- In the V1 view the user can scroll up and down to 15 configurable screens showing different measurements of the generator, the bus and the Mains.

SETUP menu

The control and protection parameters can be programmed according to the application. This can be done by scrolling through the setup menu to the appropriate parameter. Each parameter has a specific channel number and is listed in one of the 4 main SETUP menus:

- Protection Setup (PROT): Channels from 1000 to 1999 (steps of 10).
- Control Setup (CTRL): Channels from 2000 to 2999 (steps of 10).
- Input/Output Setup (I/O): Channels from 3000 to 5999 (steps of 10).
- System Setup (SYST): Channels from 6000 and up (steps of 10).

If you select SETUP then you get the following view:

```
G  0,001  PF  OkW
I-L1                OA
PROTECTION SETUP
PROT CTRL  IIO  SYST
```

The fourth line is the entry selection for the Menu system. If the SEL button is pressed, the menu indicated with an underscore will be entered.

If PROT is selected, the following view will appear (example of parameter):

```
G  0,001  PF  OkW
1000  G-P> 1
Set point          -5,00%
SP  DEL  OA  OB  ENA  FC
```

For a protective function the first entry shows the “Generator reverse power (G-P>1)” setting.

Scrolling down will give all the protection parameters:

- The first line shows some generator data.
- The second line shows the channel number and the name of the parameter.
- The third line shows the value of a set point of this parameter.
- The fourth line shows the different possible set points. In this example:

SP	SET POINT, the alarm set point is adjusted in the set point menu. The setting is a percentage of the nominal values.
DEL	DELAY, the timer setting is the time that must expire from the alarm level is reached until the alarm occurs.
OA	OUTPUT A, a relay can be activated by output A.
OB	OUTPUT B, a relay can be activated by output B.
ENA	ENABLE, the alarm can be activated or deactivated. ON means always activated, RUN means that the alarm has run status. This means it is activated when the running signal is present.
FC	FAIL CLASS, when the alarm occurs the unit will react depending on the selected fail class.

The user can scroll through this list and select one set point with the SEL button.

After selection of SP the following view will be visible:

```
G  0,001  PF  OkW
ENTER PASSWORD      2003
ENTER
```

If the correct password is entered, the following view appears:

```
G  0,001  PF  OkW
1001  G-P> 1
-50,0,,,, -5,0,,,, 0,0%
RESET                                SAVE
```

Now the user can change the SP of parameter “G-P>1”. This can be done with the scroll buttons. Then the user has to select SAVE to save the new settings. To exit the user has to press the BACK button several times, until the main view appears.

The JUMP button

Instead of navigating through the entire menu, the user can jump directly to the required parameter, if he knows the channel number of that specific parameter.

If the JUMP button is pushed the password view will appear. Not all parameters can be changed by the end-user. The required password level for each parameter is given in the set point list.

The following menus can only be reached using the JUMP button:

- 9000 Software version
- 9020 Service port
- 911X User password

Level 2 and Level 3 passwords can only be set through the Atlas Copco Utility Software PC Software.

- 9120 Service menu
- 9130 Single/Split/Three phase
- 9140 Angle comp. BB/G

Use the UP and DOWN buttons to change the settings and the SEL button to store the new setting.

4.6.4.3 Changing settings

Menu flow:

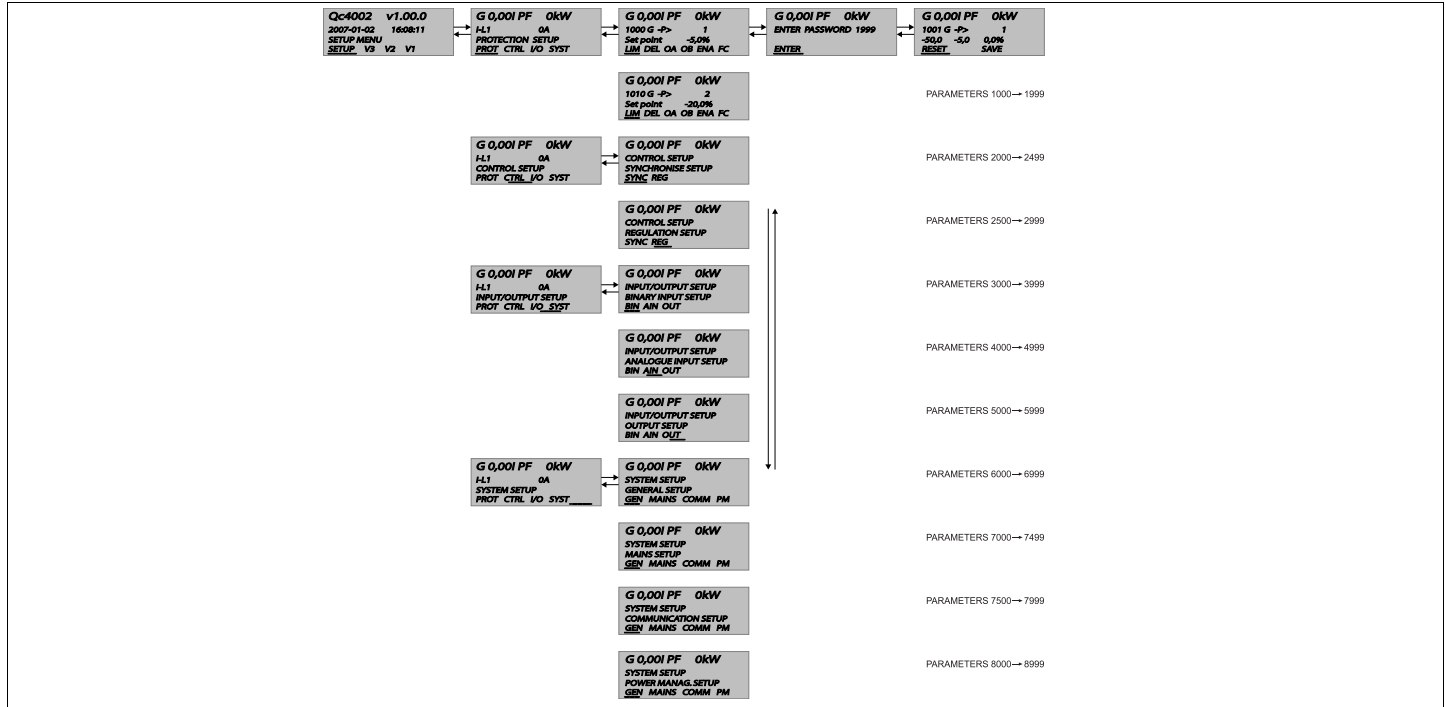

The menu flow is similar in the CONTROL SETUP, I/O SETUP and SYSTEM SETUP.



For more details on the Setup menu we refer to the Qc4002™ MkII User Manual.

Passwords

Changing different parameters requires different password levels. Some parameters cannot be changed by the end-customer because of safety reasons.

There are 3 different password levels:

- User password (default setting 2003)
- Service password
- Master password

Once the password has been entered, the user can change all the accessible set points.

The user can change the User password (go with JUMP button to channel 9116).

Languages

English is the default language ex-factory.

Changing parameters

Consult the Qc4002™ MkII user manual for all customer level parameters, which can be accessed using password "2003".

In order to receive the default parameters for your unit, please contact Atlas Copco Service staff.

4.6.4.4 Standard modes

The unit has four different running modes and one block mode. The required mode can be selected via the MODE push button. Repeat pushing the button until the required mode appears on the display, then press SEL to select or BACK to cancel.

This screen appears when pressing the MODE push button.

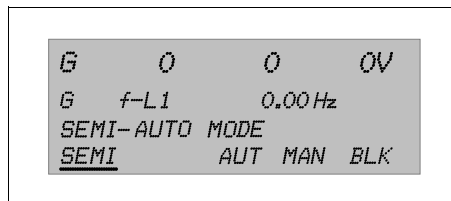

Auto mode

In this mode the Qc4002™ MkII controls the genset and the circuit breakers (generator breaker GB and mains breaker MB) automatically according to the operational state.



When operating in AUTO mode the STOP and GB Open/Close button will not function.

Semi-Auto mode

In semi-auto mode the operator has to initiate all sequences. This can be done via the push button functions, modbus commands or digital inputs. When started in semi-automatic mode, the genset will run at nominal values.

Test mode

Enables the user to test the generator on a regular basis. The generator will follow a predefined sequence of actions.

In this mode it is possible to perform the following tests:

- Simple test
- Load test
- Full test

Manual mode

When manual mode is selected, the generator frequency and voltage can be controlled with external inputs.



MAN mode cannot be selected, when AUTO mode is selected. To go from AUTO to MAN it is necessary to go to SEMI-AUTO to make MAN available.

Block mode

When the block mode is selected, the unit is locked for certain actions. This means that it cannot start the genset or perform any breaker operations.

To change the running mode from the display, the user will be asked for a password before the change can be made. It is not possible to select 'block mode' when running feedback is present.

The purpose of the block mode is to make sure that the genset does not start for instance during maintenance work. If the digital inputs are used to change the mode, then it is important to know that the input configured to block mode is a constant signal. So, when it is ON the unit is in a blocked state, and when it is OFF, it returns to the mode it was in before block mode was selected.

4.6.4.5 Standard applications

In the Qc4002™ MkII module 9 application types can be selected. A combination of each application type with the running mode results in a specific application.

Genset mode	Running mode				
	Auto	Semi	Test	Man	Block
Automatic Mains Failure (no back sync.)	X	(X)	X	X	X
Automatic Mains Failure (with back sync.)	X	(X)	X	X	X
Island operation	X	X		X	X
Fixed power/base load	X	X	X	X	X
Peak shaving	X	X	X	X	X
Load take over	X	X	X	X	X
Mains power export	X	X	X	X	X
Multiple gensets, load sharing	X	X		X	X
Multiple gensets, power management	X	(X)	X	X	X

Depending on the application the user has to connect extra wiring to terminal blocks X25. These terminal blocks can be found inside the control box on a DIN-rail. We refer to the circuit diagram 1636 0040 25/00 for the correct connections.

Island operation

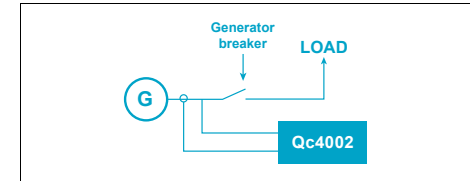

This application is possible in combination with SEMI-AUTO mode or AUTO mode. The internal real time clock timer can only be used in AUTO

This operation type is selected for installations with one or more generators, but always without the Mains (= stand-alone). In practice up to 16 generators can be installed in parallel.

Installation wiring

- Terminals X25.10/X25.11 have to be linked. The module always needs a feedback signal from the Mains Breaker MB. In Island mode there is no MB in the system. In this case the MB opened signal is simulated with this link.
- The busbar sensing lines have to be wired to the corresponding control module inputs. Place bridge between:
 - X25.33 (L1) => X25.3
 - X25.34 (L2) => X25.4
 - X25.35 (L3) => X25.5
 - X25.36 (N) => X25.6

(The busbar = power cables between GB and load)

- For Remote Start operation:
 - wire the RS switch between X25.9 & X25.10.
- For Paralleling applications with other generators:
 - See “Paralleling” to set up generator for paralleling.

Automatic Mains Failure (AMF) operation

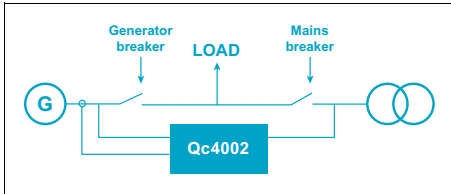

This application is only possible in combination with the AUTO mode. If the SEMI-AUTO mode is selected the AMF operation will NOT function!

The unit automatically starts the genset and switches to generator supply at a mains failure after an adjustable delay time.

- AMF no back synchronisation:

When the mains returns, the unit will switch back to mains supply and cool down and stop the genset. The switching back to mains supply is done without back synchronisation when the adjusted ‘Mains OK delay’ has expired.

- AMF with back synchronisation:

When the mains returns, the unit will synchronise the mains breaker to the busbar when the ‘Mains OK delay’ has expired. Then the genset cools down and stops.

Installation wiring

- The link between X25.10/X25.11 has to be removed.
- Mains breaker feedback lines have to be wired to X25.10/X25.11/X25.12.
- Mains breaker control lines have to be wired to X25.13/X25.14/X25.15/X25.16. These terminals are voltage free contacts. The power for the MB has to be supplied by the customer (24 Vdc/ 230 Vac) (max. contact rating K11, K12 = 250 V/ 16 A).
- The Mains sensing lines L1/L2/L3/N have to be wired to terminals X25.3/X25.4/X25.5/X25.6.
- Make sure the connections between X25.33 & X25.3; X25.34 & X25.4; X25.35 & X25.5; X25.36 & X25.6 are removed.
- If back synchronisation is enabled, all settings for paralleling set up (see “Paralleling”) must be verified also.

Peak Shaving (PS) operation

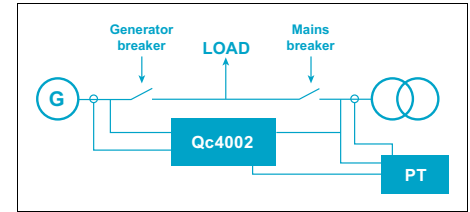

This application is normally used in combination with the AUTO mode. Installation with the Mains.

The generator will start up when the mains imported power (measured through an optional Power Transducer = PT) exceeds a defined level. The generator will synchronise with the bus, and will take load until the defined allowable mains imported power level is reached.

When the mains imported power decreases below the defined mains imported power level for a defined time, the generator will unload and disconnect from the bus. Then the generator will go into cool down.

Installation wiring

- The link between X25.10/X25.11 has to be removed.
- Mains breaker feedback lines have to be wired to X25.10/X25.11/X25.12.
- Mains breaker control lines have to be wired to X25.13/X25.14/X25.15/X25.16. These terminals are voltage free contacts. The power for the MB has to be supplied by the customer (24 Vdc/ 230 Vac) (max. contact rating K11, K12 = 250 V /16 A).
- The Mains sensing lines L1/L2/L3/N have to be wired to terminals X25.3/X25.4/X25.5/X25.6.
- Make sure the connections between X25.33 & X25.3; X25.34 & X25.4; X25.35 & X25.5; X25.36 & X25.6 are removed.
- Power Transducer lines have to be wired to X25.21 (input) and X25.22 (GND).
- Verify all settings for paralleling set up (see “Paralleling”).

Fixed Power (FP) operation

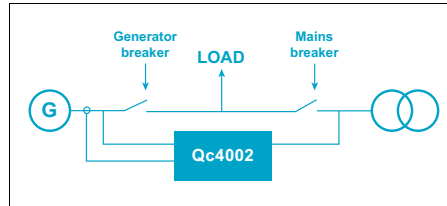

This application is possible in combination with SEMI-AUTO mode or AUTO mode. Normally it is used in combination with SEMI-AUTO mode in installations with the Mains. The internal real time clock timer can only be used in AUTO mode.

The generator will deliver a defined fixed power to the load or to the Mains.

Installation wiring

- The link between X25.10/X25.11 has to be removed.
- Mains breaker feedback lines have to be wired to X25.10/X25.11/X25.12.

- Mains breaker control lines have to be wired to X25.13/X25.14/X25.15/X25.16. These terminals are voltage free contacts. The power for the MB has to be supplied by the customer (24 Vdc/ 230 Vac) (max. contact rating K11, K12 = 250 V /16 A).
- The Mains sensing lines L1/L2/L3/N have to be wired to terminals X25.3/X25.4/X25.5/X25.6.
- Make sure the connections between X25.33 & X25.3; X25.34 & X25.4; X25.35 & X25.5; X25.36 & X25.6 are removed.
- Verify all settings for paralleling set up (see “Paralleling”).

Load Take Over (LTO) operation

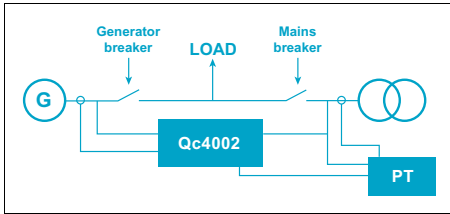

This application is normally used in combination with SEMI-AUTO mode or AUTO mode in installations with the Mains.

The purpose of the load take over mode is to transfer the load imported from the mains to the genset for operation on generator supply only.

The generator will start-up, synchronise and take over the load from the Mains gradually, before opening the Mains Breaker. To know if the load is completely taken over from the mains, an optional Power Transducer is necessary.

Installation wiring

- The link between X25.10 & X25.11 has to be removed.
- Mains breaker feedback lines have to be wired to X25.10/X25.11/X25.12.
- Mains breaker control lines have to be wired to X25.13/X25.14/X25.15/X25.16. These terminals are voltage free contacts. The power for the MB has to be supplied by the customer (24 Vdc/ 230 Vac) (max. contact rating K11, K12 = 250 V/ 16 A).
- The Mains sensing lines L1/L2/L3/N have to be wired to terminals X25.3/X25.4/X25.5/X25.6.
- Make sure the connections between X25.33 & X25.3; X25.34 & X25.4; X25.35 & X25.5; X25.36 & X25.6 are removed.
- Power Transducer lines have to be wired to X25.21 (input) and X25.22 (GND).
- Verify all settings for paralleling set up (see “Paralleling”).

Mains Power Export (MPE) operation

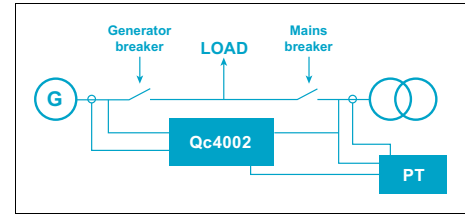

This application is possible in combination with SEMI-AUTO mode or AUTO mode. The internal real time clock timer can only be used in AUTO mode. Installation is with the Mains.

The mains power export mode can be used to maintain a constant level of power through the mains breaker. The power can be exported to the mains or imported from the mains, but always at a constant level.

Installation wiring

- The link between X25.10 & X25.11 has to be removed.
- Mains breaker feedback lines have to be wired to X25.10/X25.11/X25.12.
- Mains breaker control lines have to be wired to X25.13/X25.14/X25.15/X25.16. These terminals are voltage free contacts. The power for the MB has to be supplied by the customer (24 Vdc/ 230 Vac) (max. contact rating K11, K12 = 250 V/ 16 A).
- The Mains sensing lines L1/L2/L3/N have to be wired to terminals X25.3/X25.4/X25.5/X25.6.
- Make sure the connections between X25.33 & X25.3; X25.34 & X25.4; X25.35 & X25.5; X25.36 & X25.6 are removed.
- Power Transducer lines have to be wired to X25.21 (input) and X25.22 (GND).
- Verify all settings for paralleling set up (see “Paralleling”).

Multiple gensets with load sharing

In this application the units are enabled to share the active and reactive load equally in percentage of the nominal power. The load sharing is active when each genset is running in island mode and the generator breaker is closed.

Multiple gensets with power management (PMS)

PMS (= Power Management System) is a system that will automatically start and stop generators based on the actual load dependency. This will be done through a PMS communication between the different units connected.

PMS applications are always in combination with AUTO mode. If the SEMI-AUTO mode is selected, the PMS operation will NOT function! The Qc4002™ MkII controllers from the gensets need to be programmed as PMS in AUTO mode. When a Qc Mains controller is installed this needs to be programmed in the application that is required (AMF, LTO, FP, MPE) and AUTO mode.



By programming the parameters in AUTO mode, the generator can start up immediately. It is recommended to place the generator in SEMI-AUTO mode while programming all the PMS parameters!

Installations are possible with stand-alone generators or with the Mains (extra Qc4002™ MkII Mains is then needed). A number of Qc4002™ MkII units are being used in the power management application, i.e. one for each mains breaker (Qc4002™ MkII mains controller), if installed, and one for each generator (Qc4002™ MkII genset controller). All units communicate by means of an internal CANbus connection.

In an application with PMS it is important to program correctly the Start and Stop signals between the different generators because of the following reasons:

- The maximum load step needs to be programmed in the Qc4002™ MkII controllers. This never may exceed the power reserve of the running generators. Otherwise the gensets will go in overload with a sudden max. load increase before the next generator is started up and connected to the busbar.
- To prevent the gensets to run in a start - stop loop.

The start signal is the value of the maximum required load step.

The stop signal is the value when the generator should be stopped automatically.

Example: Installation with 3 gensets

G1 = 300 kW; G2 = 200 kW; G3 = 200 kW.

- Start signal is set at 90 kW (maximum load step < 90 kW).

Start signal if:

Total Power needed > (total available power of running gensets - set point start signal).

- Only G1 is running; at 210 kW load (300 kW - 90 kW) => G2 will be started.
- G1 & G2 are running; at 410 kW load (200 kW + 300 kW - 90 kW) => G3 will be started.
- Stop signal is set at 100 kW and priority is set as (high) G1 > G2 > G3 (low).

Stop signal if:

Total Power needed < (Total available power of running gensets - Power of generator with lowest priority - set point stop signal).

- G1 & G2 & G3 are running; at 400 kW (700 kW - 200 kW - 100 kW) => G3 will be stopped.
- G1 & G2 are running; at 200 kW (500 kW - 200 kW - 100 kW) => G2 will be stopped.

The priority on starting and stopping the generators can be chosen on priority settings or on the amount of running hours. In manual mode the start and stop sequence is determined by the chosen priority between the generators. The generator with the lowest priority will start as the latest genset and will stop as first. If running hours are chosen as priority the start and stop sequence will be defined based on the actual running hours of the different generators. The lowest running hours will get the highest priority.



When paralleling generators with PMS, it is no longer necessary to use the analogue load sharing lines. This will be done through the PMS communication lines. Use a screened CAN communication cable with a maximum total distance of 200 meters. Do not connect the cable screen to the ground! Use a 120 Ohm resistor at both end controllers of the PMS.



For more information on this option, see User Manual Qc4002™ MkII and dedicated PMS manual.

Installation wiring

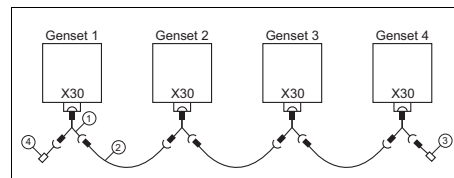

- 1 Splitter (1626 6901 00)
- 2 Cable (1626 6906 00)
- 3 End resistor (male) (1626 6926 00)
- 4 End resistor (female) (1626 6927 00)

4.6.4.6 Paralleling

Prior to starting parallel operation of two generators, following connections need to be made:

- Connect the communication cable between the generators by plugging the adapter into socket X30.
- Connect the load with the generator.

Go via the site distribution panel (to be installed by the customer) to connect the generator(s) with the load. Always connect generator with the load, and never directly with second generator.

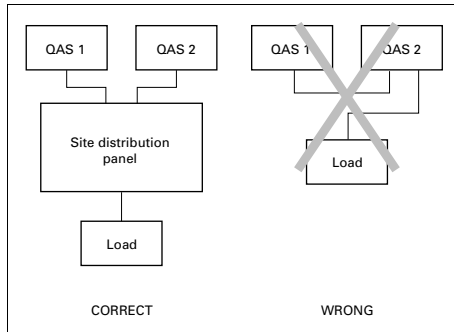

When paralleling, make sure to disable the Earth leakage relay by putting switch S13 into off position.

4.6.4.7 Overview of applications

Installations with only 1 generator

Application type	Mode	Comments
Island operation	SEMI-AUTO mode	= Local start
	AUTO mode	= Remote start
AMF operation	(SEMI-AUTO mode)	AMF operation will not function properly!
	AUTO mode	= Emergency start @ Mains Failure
Peak shaving	SEMI-AUTO mode	Only with Power Transducer (*)
	AUTO mode	Only with Power Transducer (*)
Fixed Power	SEMI-AUTO mode	
	AUTO mode	
Load Take Over	SEMI-AUTO mode	Only with Power Transducer (*)
	AUTO mode	Only with Power Transducer (*)
Mains Power Export	SEMI-AUTO mode	Only with Power Transducer (*)
	AUTO mode	Only with Power Transducer (*)

(*) A Power Transducer is a device that measures the actual power of the mains and which translates this into a 4...20 mA signal towards the Qc4002™ MkII module. For details, please contact Atlas Copco.

Installations with more generators

Application type	Mode	Comments
Island operation	SEMI-AUTO mode	= Manual paralleling between generators
	AUTO mode	= Remote paralleling between generators
AMF operation	(SEMI-AUTO mode)	AMF operation will not function properly!
	AUTO mode	PMS + Qc4002™ MkII Mains module (**)
Peak shaving	SEMI-AUTO mode	PMS + Qc4002™ MkII Mains module (**)
	AUTO mode	PMS + Qc4002™ MkII Mains module (**)
Fixed Power	SEMI-AUTO mode	PMS + Qc4002™ MkII Mains module (**)
	AUTO mode	PMS + Qc4002™ MkII Mains module (**)
Load Take Over	SEMI-AUTO mode	PMS + Qc4002™ MkII Mains module (**)
	AUTO mode	PMS + Qc4002™ MkII Mains module (**)
Main Power Export	SEMI-AUTO mode	PMS + Qc4002™ MkII Mains module (**)
	AUTO mode	PMS + Qc4002™ MkII Mains module (**)
Power Management System	(SEMI-AUTO mode)	PMS + Qc4002™ MkII Mains module (**)
	AUTO mode	PMS + Qc4002™ MkII Mains module (**)

(**) The power management system (PMS) allows communication between the Qc4002™ MkII modules over CAN-bus. It has a fully intelligent system, which will start/load/stop the generator according to the actual load and to the status of each generator. The installation can contain up to 16 Qc4002™ MkII modules. If the Mains is included in the installation, then an extra Qc4002™ MkII module is required. The installation can be monitored and controlled via the PMS Software Package. For details on this application, please contact Atlas Copco.



1. Each installation has to be prepared and reviewed very carefully before start-up. Wrong or incomplete wiring can damage the installation brutally!
2. Each application requires a specific combination of the following parameters:
 - Auto/ Semi-auto / Test / Manual / Block mode.
 - Island / AMF / PS / FP / LTO / MPE / PMS application type (in AUTO mode PS / FP / LTO can be combined with AMF).
 - Back synchronising enabled/disabled (parameter channel 7080).Wrong parameter settings can damage the installation brutally!
3. To be able to start up in cold conditions, parameter 6181 (Start prepare) can be changed to a higher value to have some preheating. Do not put this value above 60 seconds to avoid any possible damage.
4. For more information on the Qc4002™ MkII module and its applications, we refer to the Qc4002™ MkII User manual and the Qc4002™ Application data sheets. If you need more assistance, please contact Atlas Copco.

5 Maintenance

5.1 Maintenance schedule



Before carrying out any maintenance activity, check that the start switch is in position O and that no electrical power is present on the terminals.

Maintenance schedule	Daily	50 hrs after initial start-up	Every 500 hours	Every 1000 hours	Every 2000 hours	Yearly
Service pak		-	2912 4547 05	2912 4548 06	2912 4549 07	-
<i>For the most important subassemblies, Atlas Copco has developed service kits that combine all wear parts. These service kits offer you the benefits of genuine parts, save on administration costs and are offered at reduced price, compared to the loose components. Refer to the parts list for more information on the contents of the service kits.</i>						
Drain water from fuel filter	x					
Check/Fill fuel level (3)	x					
Empty air filter vacuator valves	x					
Check air intake vacuum indicators	x					
Check engine oil level (if necessary top up)	x					
Check coolant level	x					
Check control panel for alarms and warnings	x					
Check on abnormal noise	x					
Check function of coolant heater (option)			x			x
Replace air filter element (1)			x			x
Check/Replace safety cartridge					x	
Change engine oil (2) (6)			x	x		x
Replace engine oil filter (2)			x	x		x
Replace fuel (primary)filter(s) (5)			x	x		x
Replace fuel (secondary)filter(s) (5)			x	x		x

Maintenance schedule	Daily	50 hrs after initial start-up	Every 500 hours	Every 1000 hours	Every 2000 hours	Yearly
Service pak		-	2912 4547 05	2912 4548 06	2912 4549 07	-
Inspect/Adjust fan/alternator belt	x		x	x		x
Replace fan/alternator belt					x	
Measure alternator insulation resistance (11)				x		x
Test Earth Leakage Relay (12)			x	x		x
Check emergency stop (12)			x	x		x
Clean radiator (1)			x	x		x
Clean intercooler (1)			x	x		x
Check for obstructions on crankcase breather system / filter and hoses	x					
Replace crank case breather filter			x	x		x
Drain condensate and water from spillage-free frame or catch basin (8)			x	x		x
Check for leaks in engine-, air-, oil-, or fuel system			x	x		x
Hoses and clamps - Inspect/Replace			x	x		x
Check electrical system cables for wear				x		x
Check/Test glow plugs - grid heater					x	x
Check torque on critical bolt connections				x		x
Check electrolyte level and terminals of battery (10)			x	x		x
Analyse coolant (4) (7)			x	x		x
Check external fuel connection (option)				x		x
Grease locks and hinges			x	x		x
Check rubber flexibles (9)				x		x
Drain/Clean fuel tank water and sediment (1) (13)			x	x		x
Adjust engine inlet and outlet valves (2)			x	x		

Maintenance schedule	Daily	50 hrs after initial start-up	Every 500 hours	Every 1000 hours	Every 2000 hours	Yearly
Service pak		-	2912 4547 05	2912 4548 06	2912 4549 07	-
Check engine protective devices				x		x
Inspect starter motor					x	x
Inspect turbocharger					x	x
Inspect water pump					x	x
Inspect charging alternator					x	x
Inspection by Atlas Copco service technician			x	x		x
		Generators in stand-by application have to be tested on a regular basis. At least once a month the engine should run for one hour. If possible a high load (> 30%) should be applied so that the engine reaches its operating temperature.				

Maintenance schedule	Daily	50 km after initial start-up	Every 500 hours	Every 1000 hours	Every 2000 hours	Yearly
Service pak		-	2912 4547 05	2912 4548 06	2912 4549 07	-
<i>For the most important subassemblies, Atlas Copco has developed service kits that combine all wear parts. These service kits offer you the benefits of genuine parts, save on administration costs and are offered at reduced price, compared to the loose components. Refer to the parts list for more information on the contents of the service kits.</i>						
Check tyre pressure		x		x	x	x
Check tyres for uneven wear				x	x	x
Check torque of wheel nuts		x		x	x	x
Check coupling head	x			x	x	x
Check height of adjusting facility	x					x
Check towbar handbrake lever spring actuator, reversing lever, linkage and all movable parts for ease of movement	x	x		x	x	x
Check operation of the lights				x	x	x
Grease coupling head, towbar bearings at the housing of the overrun brake		x		x	x	x
Check brake system (if installed) and adjust if necessary		x		x	x	x
Oil or grease brake lever and moving parts such as bolts and joints		x		x	x	x
Grease sliding points on height adjusting parts				x	x	x
Check safety cable for damage				x	x	x
Check Bowden cable on height adjustable connection device for damage				x	x	x
Lubricate torsion bar axle trailing arm				x	x	x
Check brake lining wear						x
Change wheel hub bearing grease						x

Maintenance schedule	Daily	50 km after initial start-up	Every 500 hours	Every 1000 hours	Every 2000 hours	Yearly
Service pak		-	2912 4547 05	2912 4548 06	2912 4549 07	-
Check/Adjust lateral play of wheel bearing (conventional bearing)				x	x	x
Check of chassis and bolted parts				x	x	x
		Generators in stand-by application have to be tested on a regular basis. At least once a month the engine should run for one hour. If possible a high load (> 30%) should be applied so that the engine reaches its operating temperature.				

Notes:

In highly dusty environments, these service intervals do not apply. Check and/or replace filters and clean radiator on a regular basis.

- (1) More frequently when operating in a dusty environment.
- (2) Refer to engine operation manual.
- (3) After a days work.
- (4) Yearly is only valid when using PARCOOL. Change coolant every 5 years.
- (5) Gummed or clogged filters means fuel starvation and reduced engine performance. Reduce service interval in heavy duty application.
- (6) See section “Engine oil specifications”.
- (7) The following part numbers can be ordered from Atlas Copco to check on inhibitors and freezing points:
 - 2913 0028 00: refractometer
 - 2913 0029 00: pH meter
- (8) See section “Before starting”.
- (9) Replace all rubber flexibles every 5 years, according to DIN20066.
- (10) See section “Battery care”.
- (11) See section “Measuring the alternator insulation resistance”.
- (12) The function of this protection should be tested minimum on every new installation.

- (13) Water in fuel tank can be detected by means of 2914 8700 00. Drain fuel tank when water is detected.

5.1.1 Use of maintenance schedule

The maintenance schedule contains a summary of the maintenance instructions. Read the respective section before taking maintenance measures.

When servicing, replace all disengaged packing, e.g. gaskets, O-rings, washers.

For engine maintenance refer to Engine Operation Manual.

The maintenance schedule has to be seen as a guideline for units operating in a dusty environment typical to generator applications. Maintenance schedule can be adapted depending on application, environment and quality of maintenance.

5.1.2 Use of service paks

Service Paks include all genuine parts needed for normal maintenance of both generator and engine. Service Paks minimize downtime and keep your maintenance budget low.

The order number of the Service Paks are listed in the Atlas Copco Parts list (ASL). Order Service Paks at your local Atlas Copco dealer.

5.2 Preventing low loads

5.2.1 General

All engine parts are designed with tolerances to allow work under full load conditions. When operating at low load, these tolerances allow more lube oil to pass between valve guides, stems, liners and pistons due to the lower engine temperatures.

Lower combustion pressure has an influence on the piston ring operation and the combustion temperature. Low boost pressure will cause oil leakage over the turbo shaft seal.

5.2.2 Risks of low load operation

- Cylinder glazing: the cylinder bore troughs become filled with lacquer, displacing oil and thus preventing correct ring lubrication.
- Bore polishing: the bore surface becomes polished, all peaks and most troughs become worn away, also preventing correct ring lubrication.
- Heavy carbon buildup: on pistons, piston ring grooves, valves and turbo charger. Carbon buildup on pistons can cause seizure when later operating at full load.
- High oil consumption: prolonged no-load/low load operation of the engine may cause it to blue/gray smoke at low rpm with an associated increase in oil consumption

- Low combustion temperature: this will result in insufficiently burnt fuel, which will cause diluting of the lube oil. Also, unburnt fuel and lube oil can enter the exhaust manifold and eventually leak out through joints in the exhaust manifold.
- Risk for fire

5.2.3 Best practices

Reduce the low load periods to a minimum. This should be achieved by adequately sizing the unit for the application.

It is recommended that a unit is always used with a load > 30% of nominal. Corrective actions should be taken if due to circumstances this minimum load capacity cannot be obtained.

Operate the unit at full load capacity after any low load operating period. Therefore, connect the unit periodically to a load bank. Increase the load in steps of 25% every 30 minutes and allow the unit to run for 1 hour in full load condition. Gradually return the unit to the operating load.

The interval between load bank connections may vary according to the conditions present on site and the amount of load. However, a rule of thumb is to connect a unit to a load bank after every maintenance operation.

Units equipped with Qc4002™ MkII and operating in parallel with the Mains may be placed in Fixed Power or Test mode without the requirement of a load bank.

If the engine is installed as a stand-by generator, then it should be operated at full load for at least 4 hrs/year. If periodic tests are performed on a regular basis without load, these should not exceed 10 min. Full load tests help to clean out the carbon deposits in the engine and exhaust system and evaluate the engine's performance. To avoid potential problems during the test, load should be gradually increased.

In rental applications (where the load is often an unknown factor) units should be tested at full load after each rental job or every 6 months, whichever comes first.

For more info, please contact your Atlas Copco Service Center.



When a failure occurs and is deemed due to low load operation, the repairs fall outside warranty coverage.

5.3 Alternator maintenance procedures

5.3.1 Measuring the alternator insulation resistance

A 500 V megger is required to measure the alternator insulation resistance.

If the N-terminal is connected to the earthing system, it must be disconnected from the earth terminal. Disconnect the AVR.

Connect the megger between the earth terminal and terminal L1 and generate a voltage of 500 V. The scale must indicate a resistance of at least 5 MΩ.

Refer to the alternator operating and maintenance instructions for more details.

5.4 Engine maintenance procedures

Refer to the Engine Operation Manual for a full maintenance schedule.

5.4.1 Engine oil level check

Consult the Engine Operation Manual for the oil specifications, viscosity recommendations and oil change intervals. For the intervals, see also section “Maintenance schedule” on page 87.

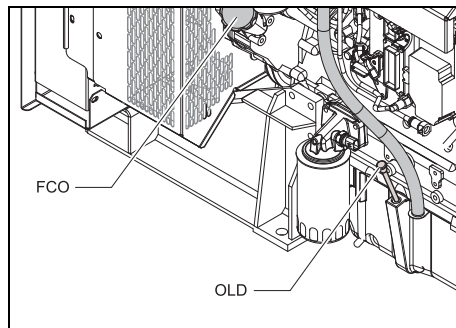

- Check the engine oil level by using the oil level dipstick (OLD).
- Top up with oil (FCO), if necessary.

Refer to the Engine Operation Manual for more detailed instructions.

5.4.2 Engine oil and oil filter change

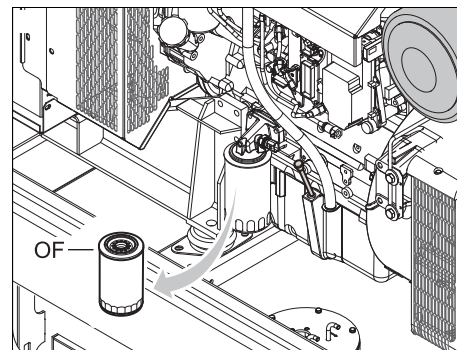

Replacing the oil filter element



Observe all relevant environmental and safety precautions.

- Place an appropriate drain pan under the oil drain flexible.
- Remove the drain plug from the oil drain flexible to drain the oil.
- Replace the seal of the drain plug.
- Install and tighten the drain plug on the oil drain flexible.
- Unscrew the oil filter element (OF) from the adapter head.

- Clean the adapter head sealing surface. Lightly oil the gasket of the new element and screw the latter onto the adapter head until the gasket is properly seated, then tighten with both hands.



Never leave spilled liquids such as fuel, oil, water and cleansing agents in or around the generator.

- Top up the engine oil level.
- Run the engine for 1 minute and check the oil level using the oil level dipstick.

5.4.3 Coolant check

5.4.3.1 Monitoring coolant condition

In order to guarantee the lifetime and quality of the product, thus to optimise engine protection, regular coolant-condition-analysis is advisable.

The quality of the product can be determined by three parameters.

Visual check

- Verify the outlook of the coolant regarding colour and make sure that no loose particles are floating around.



**Long service intervals
5-year drain interval to minimize
service costs (when used in
accordance with the instructions).**

pH measurement

- Check the pH value of the coolant using a pH-measuring device.
- The pH-meter can be ordered from Atlas Copco with part number 2913 0029 00.
- Typical value for EG = 8.6.
- If the pH-level is below 7 or above 9.5, the coolant should be replaced.

Glycol concentration measurement

- To optimise the unique engine protection features of the PARCOOL EG the concentration of the Glycol in the water should be always above 33 vol.%.
- Mixtures with more than 68 vol.% mix ratio in water are not recommended, as this will lead to high engine operating temperatures.
- A refractometer can be ordered from Atlas Copco with part number 2913 0028 00.



In case of a mix of different coolant products this type of measurement might provide incorrect values.

5.4.3.2 Topping up of coolant

- Verify if the engine cooling system is in a good condition (no leaks, clean,...).
- Check the condition of the coolant.
- If the condition of the coolant is outside the limits, the complete coolant should be replaced (see section “Replacing the coolant”).
- Always top-up with PARCOOL EG.
- Topping up the coolant with water only, changes the concentration of additives and is therefore not allowed.

5.4.3.3 Replacing the coolant

Drain

- Completely drain the entire cooling system.
- Used coolant must be disposed or recycled in accordance with laws and local regulations.

Flush

- Flush twice with clean water. Used coolant must be disposed or recycled in accordance with laws and local regulations.
- From the Atlas Copco Instruction book, determine the amount of PARCOOL EG required and pour into the radiator top tank.
- It should be clearly understood that the risk for contamination is reduced in case of proper cleaning.
- In case a certain content of 'other' coolant remains in the system, the coolant with the lowest properties influences the quality of the 'mixed' coolant.

Fill

- To assure proper operation and the release of trapped air, run the engine until normal engine operation temperature is reached. Turn off the engine and allow to cool.
- Recheck coolant level and add if necessary.

5.5 Adjustments and service procedures

5.5.1 Cleaning coolers

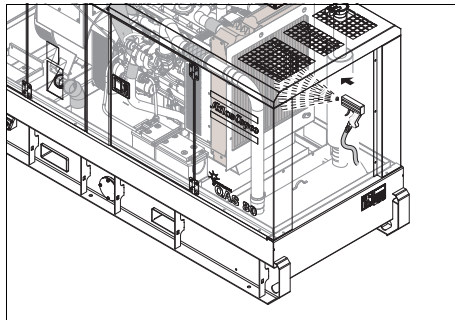
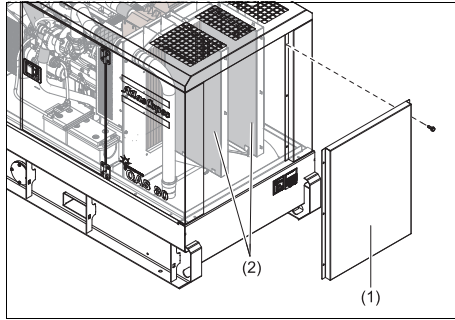

- Keep the water cooler (2) clean to maintain the cooling efficiency.
- The engine water cooler (2) is accessible via the service door (1) at the front of the unit.



Remove any dirt from the coolers with a fibre brush. Never use a wire brush or metal objects.

- Steam cleaning in combination with a cleansing agent may be applied.



To avoid damaging the coolers, angle between jet and coolers should be approx. 90°. Protect the electrical and controlling equipment, air filters, etc. against penetration of moisture. Make sure to not steam clean the alternator.

- Close the service door(s).



Never leave spilled liquids such as fuel, oil, water and cleansing agents in or around the generator.

5.5.2 Cleaning fuel tank

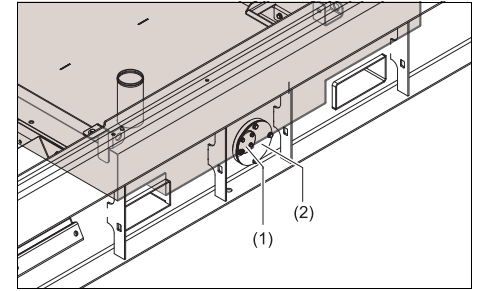

Observe all relevant environmental and safety precautions.

- Place an appropriate drain pan under the drain plug of the fuel tank.
- Remove the flange (2) and the drain plug (1).
- Slope the unit approx. 15° to remove all fuel, dirt and water.
- Clean the fuel tank and fix the drain plug and flange handtight.



Never leave spilled liquids such as fuel, oil, water and cleansing agents in or around the generator.

- Refill the fuel tank with clean fuel.

5.5.3 Battery care



Before handling batteries, read the relevant safety precautions and act accordingly.

If the battery is still dry, it must be activated as described in section “Activating a dry-charged battery”.

The battery must be in operation within 2 months from being activated; if not, it needs to be recharged first.

5.5.3.1 Electrolyte



Read the safety instructions carefully.

Electrolyte in batteries is a sulphuric acid solution in distilled water.

The solution must be made up before being introduced into the battery.

5.5.3.2 Activating a dry-charged battery

- Take out the battery.
- Battery and electrolyte must be at equal temperature above 10°C.
- Remove cover and/or plug from each cell.
- Fill each cell with electrolyte until the level reaches 10 to 15 mm above the plates, or to the level marked on the battery.

- Rock the battery a few times so that possible air bubbles can escape; wait 10 minutes and check the level in each cell once more; if required, add electrolyte.
- Refit plugs and/or cover.
- Place the battery in the generator.

5.5.3.3 Recharging a battery

Before and after charging a battery, always check the electrolyte level in each cell; if required, top up with distilled water only. When charging batteries, each cell must be open, i.e. plugs and/or cover removed.



Use a commercial automatic battery charger according to its manufacturer’s instructions.

Apply with preference the slow charging method and adjust the charge current according to the following rule of thumb: battery capacity in Ah divided by 20 gives safe charging current in Amp.

5.5.3.4 Make-up distilled water

The amount of water evaporating from batteries is largely dependant on the operating conditions, i.e. temperatures, number of starts, running time between start and stop, etc...

If a battery starts to need excessive make-up water, this points to overcharging. Most common causes are high temperatures or a too high voltage regulator setting.

If a battery does not need any make-up water at all over a considerable time of operation, an undercharged battery condition may be caused by poor cable connections or a too low voltage regulator setting.

5.5.3.5 Periodic battery service

- Keep the battery clean and dry.
- Keep the electrolyte level at 10 to 15 mm above the plates or at the indicated level; top up with distilled water only. Never overfill, as this will cause poor performance and excessive corrosion.
- Record the quantity of distilled water added.
- Keep the terminals and clamps tight, clean, and lightly covered with petroleum jelly.
- Carry out periodic condition tests. Test intervals of 1 to 3 months, depending on climate and operating conditions, are recommended.
- If doubtful conditions are noticed or malfunctions arise, keep in mind that the cause may be in the electrical system, e.g. loose terminals, voltage regulator maladjusted, poor performance of generator, etc...

5.5.4 Servicing air filter engine

5.5.4.1 Main parts

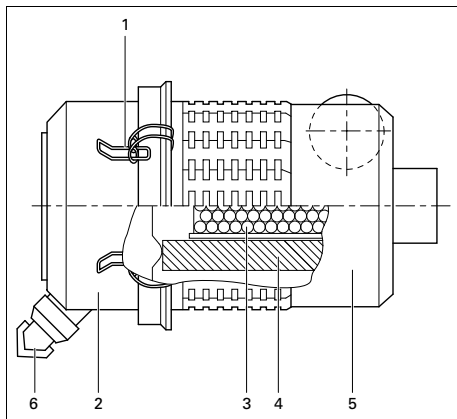

- | | |
|---|------------------|
| 1 | Snap clips |
| 2 | Dust trap |
| 3 | Safety cartridge |
| 4 | Filter element |
| 5 | Filter housing |
| 6 | Dust evacuator |

5.5.4.2 Recommendation



The Atlas Copco air filters are specially designed for the application. The use of non-genuine air filters may lead to severe damage of engine and/or alternator. Never run the generator without air filter element.

- New elements must also be inspected for tears or punctures before installation.
- Discard the filter element (4) when damaged.
- In heavy duty applications it is recommended to install a safety cartridge which can be ordered with part no.: 2914 9307 00.
- A dirty safety cartridge (3) is an indication of a malfunctioning air filter element (4). Replace the element and the safety cartridge in this case.
- The safety cartridge (3) cannot be cleaned.

5.5.4.3 Cleaning the dust trap

To remove dust from the dust trap (2) pinch the dust evacuator (6) several times.

5.5.4.4 Replacing the air filter element

- Release the snap clips (1) and remove the dust trap (2). Clean the trap.
- Remove the element (4) from the housing (5).
- Reassemble in reverse order of dismantling.
- Inspect and tighten all air intake connections.
- Reset the vacuum indicator.

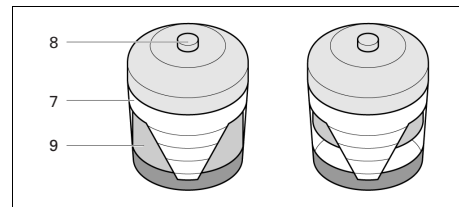

- | | |
|---|------------------------------------|
| 7 | Air filter contamination indicator |
| 8 | Reset button |
| 9 | Yellow indicator |

5.5.5 Replacing fuel filter element

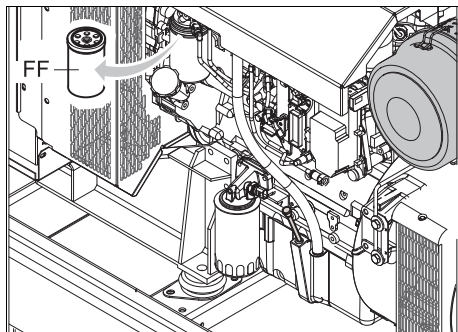

Replacing the filter element:

- Unscrew the filter element (FF) from the adapter head.
- Clean the adapter head sealing surface. Lightly oil the gasket of the new element and screw the latter onto the header until the gasket is properly seated, then tighten with both hands.
- Check for fuel leaks once the engine has been restarted.

5.6 Engine consumable specifications

5.6.1 Engine fuel specifications

For fuel specifications, please contact your Atlas Copco Customer Center.

5.6.2 Engine oil specifications



It is strongly recommended to use Atlas Copco branded lubrication oils.

High-quality, mineral, hydraulic or synthesized hydrocarbon oil with rust and oxidation inhibitors, anti-foam and anti-wear properties is recommended.

The viscosity grade should correspond to the ambient temperature and ISO 3448, as follows:

Engine	Type of lubricant
between -10°C and 50°C	PAROIL E or PAROIL E Mission Green
between -25°C and 50°C	PAROIL Extra



Never mix synthetic with mineral oil.

When changing from mineral to synthetic oil (or the other way around), you will need to do an extra rinse.

After doing the complete change procedure to synthetic oil, run the unit for a few minutes to allow good and complete circulation of the synthetic oil. Then drain the synthetic oil again and fill again with new synthetic oil. To set correct oil levels, proceed as in normal instruction.

Specifications PAROIL

PAROIL from Atlas Copco is the ONLY oil tested and approved for use in all engines built into Atlas Copco compressors and generators.

Extensive laboratory and field endurance tests on Atlas Copco equipment have proven PAROIL to match all lubrication demands in varied conditions. It meets stringent quality control specifications to ensure your equipment will run smoothly and reliably.

The quality lubricant additives in PAROIL allow for extended oil change intervals without any loss in performance or longevity.

PAROIL provides wear protection under extreme conditions. Powerful oxidation resistance, high chemical stability and rust-inhibiting additives help reduce corrosion, even within engines left idle for extended periods.

PAROIL contains high quality anti-oxidants to control deposits, sludge and contaminants that tend to build up under very high temperatures.

PAROIL's detergent additives keep sludge forming particles in a fine suspension instead of allowing them to clog your filter and accumulate in the valve/rocker cover area.

PAROIL releases excess heat efficiently, whilst maintaining excellent bore-polish protection to limit oil consumption.

PAROIL has an excellent Total Base Number (TBN) retention and more alkalinity to control acid formation.

PAROIL prevents Soot build-up.

PAROIL is optimized for the latest low emission EURO-3 & -2, EPA TIER II & III engines running on low sulphur diesel for lower oil and fuel consumption.

PAROIL Extra

PAROIL Extra is a synthetic ultra high performance diesel engine oil with a high viscosity-index. Atlas Copco PAROIL Extra is designed to provide excellent lubrication from start-up in temperatures as low as -25°C (-13°F).

	Litre	US gal	Imp gal	cu.ft	Order number
can	5	1.3	1.1	0.175	1630 0135 00
can	20	5.3	4.4	0.7	1630 0136 00

PAROIL E

PAROIL E is a mineral based high performance diesel engine oil with a high viscosity-index. Atlas Copco PAROIL E is designed to provide a high level of performance and protection in standard ambient conditions as from -10°C (14°F).

	Litre	US gal	Imp gal	cu.ft	Order number
can	5	1.3	1.1	0.175	1615 5953 00
can	20	5.3	4.4	0.7	1615 5954 00
barrel	209	55.2	46	7.32	1615 5955 00
barrel	1000	264	220	35	1630 0096 00

PAROIL E Mission Green

PAROIL E Mission Green is a mineral based high performance diesel engine oil with a high viscosity-index. Atlas Copco PAROIL E Mission Green is designed to provide a high level of performance and protection in standard ambient conditions as from -10°C (14°F).

	Litre	US gal	Imp gal	cu.ft	Order number
can	5	1.3	1.1	0.175	1630 0471 00
can	20	5.3	4.4	0.7	1630 0472 00
barrel	209	55.2	46	7.32	1630 0473 00

5.6.3 Engine coolant specifications



Never remove the cooling system filler cap while coolant is hot. The system may be under pressure. Remove the cap slowly and only when coolant is at ambient temperature. A sudden release of pressure from a heated cooling system can result in personal injury from the splash of hot coolant. It is strongly recommended to use Atlas Copco branded coolant.

The use of the correct coolant is important for good heat transfer and protection of liquid-cooled engines. Coolants used in these engines must be mixtures of good quality water (distilled or de-ionised), special coolant additives and if necessary freeze protection. Coolant that is not to manufacturer's specification will result in mechanical damage of the engine.

The freezing point of the coolant must be lower than the freezing point that can occur in the area. The difference must be at least 5°C. If the coolant freezes, it may crack the cylinder block, radiator or coolant pump.

Consult the engine's operation manual and follow the manufacturer's directions.



Never mix different coolants and mix the coolant components outside the cooling system.

Specifications PARCOOL EG

PARCOOL EG is the only coolant that has been tested and approved by all engine manufacturers currently in use in Atlas Copco compressors and generators.

Atlas Copco's PARCOOL EG extended life coolant is the new range of organic coolants purpose designed to meet the needs of modern engines. PARCOOL EG can help prevent leaks caused by corrosion. PARCOOL EG is also fully compatible with all sealants and gasket types developed to join different materials used within an engine.

PARCOOL EG is a ready to use Ethylene Glycol based coolant, premixed in an optimum 50/50 dilution ratio, for antifreeze protection guaranteed to -40°C.

Because PARCOOL EG inhibits corrosion, deposit formation is minimized. This effectively eliminates the problem of restricted flow through the engine coolant ducts and the radiator, minimizing the risk for engine overheating and possible failure.

It reduces water pump seal wear and has excellent stability when subjected to sustained high operating temperatures.

PARCOOL EG is free of nitride and amines to protect your health and the environment. Longer service life reduces the amount of coolant produced and needing disposal to minimise environmental impact.

	Litre	US gal	Imp gal	cu.ft	Order number
can	5	1.3	1.1	0.175	1604 5308 00
can	20	5.3	4.4	0.7	1604 5307 01
barrel	210	55.2	46	7.35	1604 5306 00

To ensure protection against corrosion, cavitation and formation of deposits, the concentration of the additives in the coolant must be kept between certain limits, as stated by the manufacturer's guidelines. Topping up the coolant with water only, changes the concentration and is therefore not allowed.

Liquid-cooled engines are factory-filled with this type of coolant mixture.

6 Checks and trouble shooting



Never perform a test run with connected power cables. Never touch an electrical connector without a voltage check.

When a failure occurs, always report what you experienced before, during and after the failure. Information with regard to the load (type, size, power factor, etc.), vibrations, exhaust gas colour, insulation check, odours, output voltage, leaks and damaged parts, ambient temperature, daily and normal maintenance and altitude might be helpful to quickly locate the problem. Also report any information regarding the humidity and location of the generator (e.g. close to sea).

6.1 Checks

6.1.1 Checking voltmeter P4

- Put a voltmeter in parallel with voltmeter P4 on the control panel.
- Check that the read-out of both voltmeters is the same.
- Stop the generator and disconnect one terminal.
- Check that the internal resistance of the voltmeter is high.

6.1.2 Checking ammeters P1, P2 and P3

- Measure the outgoing current during the load, by means of a clamp-on probe.
- Compare the measured current with the current indicated on ammeter. Both readings should be the same.



P1, P2, P3 and P4 are only provided on units with Qc1002™ and Qc2002™ controller.

6.2 Engine troubleshooting

The table below gives an overview of the possible engine problems and their possible causes.

The starter motor turns the engine too slowly

- Battery capacity too low.
- Bad electrical connection.
- Fault in starter motor.
- Wrong grade of lubricating oil.

The engine does not start or is difficult to start

- Starter motor turns engine too slowly.
- Fuel tank empty.
- Fault in fuel control solenoid.
- Restriction in a fuel pipe.
- Fault in fuel lift pump.
- Dirty fuel filter element.
- Air in fuel system.
- Fault in atomisers.
- Cold start system used incorrectly.
- Fault in cold start system.
- Restriction in fuel tank vent.
- Wrong type or grade of fuel used.
- Restriction in exhaust pipe.

Not enough power

- Restriction in a fuel pipe.
- Fault in fuel lift pump.
- Dirty fuel filter element.
- Restriction in air filter/cleaner or induction system.
- Air in fuel system.
- Fault in atomisers or atomisers of an incorrect type.
- Restriction in fuel tank vent.
- Wrong type or grade of fuel used.
- Restricted movement of engine speed control.
- Restriction in exhaust pipe.
- Engine temperature is too high.
- Engine temperature is too low.

Misfire

- Restriction in a fuel pipe.
- Fault in fuel lift pump.
- Dirty fuel filter element.
- Air in fuel system.
- Fault in atomisers or atomisers of an incorrect type.
- Fault in cold start system.
- Engine temperature is too high.
- Incorrect valve tip clearances.

The pressure of the lubricating oil is too low

- Wrong grade of lubricating oil.
- Not enough lubricating oil in sump.
- Defective gauge.
- Dirty lubricating oil filter element.

High fuel consumption

- Restriction in air filter/cleaner or induction system.
- Fault in atomisers or atomisers of an incorrect type.
- Fault in cold start system.
- Wrong type or grade of fuel used.
- Restricted movement of engine speed control.
- Restriction in exhaust pipe.
- Engine temperature is too low.
- Incorrect valve tip clearances.

Black exhaust smoke

- Restriction in air filter/cleaner or induction system.
- Fault in atomisers or atomisers of an incorrect type.
- Fault in cold start system.
- Wrong type or grade of fuel used.
- Restriction in exhaust pipe.
- Engine temperature is too low.

- Incorrect valve tip clearances.
- Engine overload.

Blue or white exhaust smoke

- Wrong grade of lubricating oil.
- Fault in cold start system.
- Engine temperature is too low.

The engine knocks

- Fault in fuel lift pump.
- Fault in atomisers or atomisers of an incorrect type.
- Fault in cold start system.
- Wrong type or grade of fuel used.
- Engine temperature is too high.
- Incorrect valve tip clearances.

The engine runs erratically

- Fault in fuel control.
- Restriction in a fuel pipe.
- Fault in fuel lift pump.
- Dirty fuel filter element.
- Restriction in air filter/cleaner or induction system.
- Air in fuel system.
- Fault in atomisers or atomisers of an incorrect type.

- Fault in cold start system.
- Restriction in fuel tank vent.
- Restricted movement of engine speed control.
- Engine temperature is too high.
- Incorrect valve tip clearances.

Vibration

- Fault in atomisers or atomisers of an incorrect type.
- Restricted movement of engine speed control.
- Engine temperature is too high.
- Fan damaged.
- Fault in engine mounting or flywheel housing.

The pressure of the lubricating oil is too high

- Wrong grade of lubricating oil.
- Defective gauge.

The engine temperature is too high

- Restriction in air filter/cleaner or induction system.
- Fault in atomisers or atomisers of an incorrect type.
- Fault in cold start system.
- Restriction in exhaust pipe.
- Fan damaged.
- Too much lubricating oil in sump.
- Restriction in air or coolant passages of radiator.

Crankcase pressure

- Restriction in breather pipe.
- Vacuum pipe leaks or fault in exhaust.

Bad compression

- Restriction in air filter/cleaner or induction system.
- Incorrect valve tip clearances.

The engine starts and stops

- Dirty fuel filter element.
- Restriction in air filter/cleaner or induction system.
- Air in fuel system.

The engine shuts down after approx. 15 sec.

- Bad connection towards oil pressure switch/coolant temperature switch

6.3 Alternator troubleshooting

<i>Symptom</i>	<i>Possible cause</i>	<i>Corrective action</i>
<i>Alternator gives 0 Volt</i>	Blown fuse. No residual voltage.	Replace fuse. Excite the alternator by applying a 12V battery voltage with a 30 Ω resistor in series on the + and - terminals of the electronic regulator, respecting the polarities.
<i>After being excited the alternator still gives 0 Volt.</i>	Connections are interrupted.	Check connection cables, measure winding resistance and compare with values mentioned in the alternator manual.
<i>Low voltage at no load</i>	Voltage potentiometer out of setting. Intervention of protection. Winding failure.	Reset voltage. Check frequency/voltage regulator. Check windings.
<i>High voltage at no load</i>	Voltage potentiometer out of setting. Failed regulator.	Reset voltage. Substitute regulator.
<i>Lower than rated voltage at load</i>	Voltage potentiometer out of setting. Intervention by protection. Failed regulator. Rotating bridge failure.	Reset voltage potentiometer. Current too high, power factor lower than 0.8; speed lower than 10% of rated speed. Substitute regulator. Check diodes, disconnect cables.
<i>Higher than rated voltage at load</i>	Voltage potentiometer out of setting. Failed regulator.	Reset voltage potentiometer. Substitute regulator.
<i>Unstable voltage</i>	Speed variation in engine. Regulator out of setting.	Check regularity of rotation. Regulate stability of regulator by acting on STABILITY potentiometer.

6.4 Solving controller alarms

6.4.1 Qc1002™ and Qc2002™ alarms and remedies

6.4.1.1 Alarm overview

Possible alarms appearing in the alarm list:

LOW OIL PRESSURE



HIGH COOLANT TEMPERATURE



CHARGING ALTERNATOR

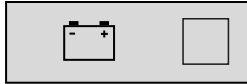

LOW FUEL LEVEL

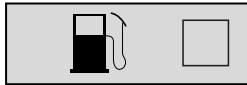

GENERATOR OVERVOLTAGE

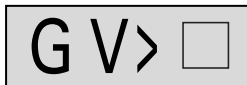

GENERATOR UNDER-VOLTAGE



GENERATOR OVER-FREQUENCY

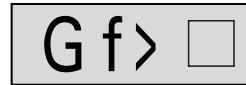

GENERATOR UNDER-FREQUENCY



SERVICE TIMER 1

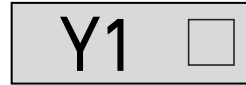

SERVICE TIMER 2



ENGINE ALARM



EMERGENCY STOP



START FAILURE



STOP FAILURE

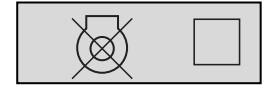

HZ/V FAILURE (Qc2002™ alarm)



OIL LEVEL (Qc2002™ alarm)



OIL TEMPERATURE (Qc2002™ alarm)



General groups of Alarms

- Warning: Alarm LED lights up + Alarm pop-up appears on the display + Alarm relay is empowered (if configured)
- Trip of GB: ‘Warning’ actions + Generator Contactor opens
- Trip and Stop: ‘Trip of GB’ actions + unit stops after Cooldown
- Shutdown: ‘Trip of GB’ actions + unit stops immediately

6.4.1.2 Fail classes

All the activated alarms have their own pre-defined fail class.

All alarms are enabled according to one of these three statuses:

- disabled alarm, no supervision of alarm (OFF).
- enabled alarm, supervision of alarm all the time (ON).
- running alarm, only supervision when the machine is running (RUN).

6.4.1.3 Solving alarms

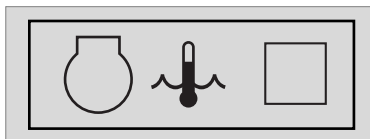

In case an Alarm occurs, a pop-up window will automatically be displayed for as long as the alarm is active, no matter which view is active. The flashing red alarm LED will light up. The alarm icons will be shown together with an acknowledgement check-box.

Push the ENTER button to acknowledge the alarm.

When the alarm has been acknowledged, a V-marking will appear in the check-box and the red alarm LED will light up continuously.



An alarm should always be acknowledged before solving the problem that causes the alarm.

The Alarm Display can always be left or entered again by pushing the BACK button.

If more than one alarm occurs, it is possible to scroll through the alarm messages with the UP and DOWN push buttons. The newest alarm will be placed at the bottom of the list (meaning that the older alarm stays at the display when a newer alarm occurs).

If one or more than one alarm is present, an arrow at the right of the display will be shown.

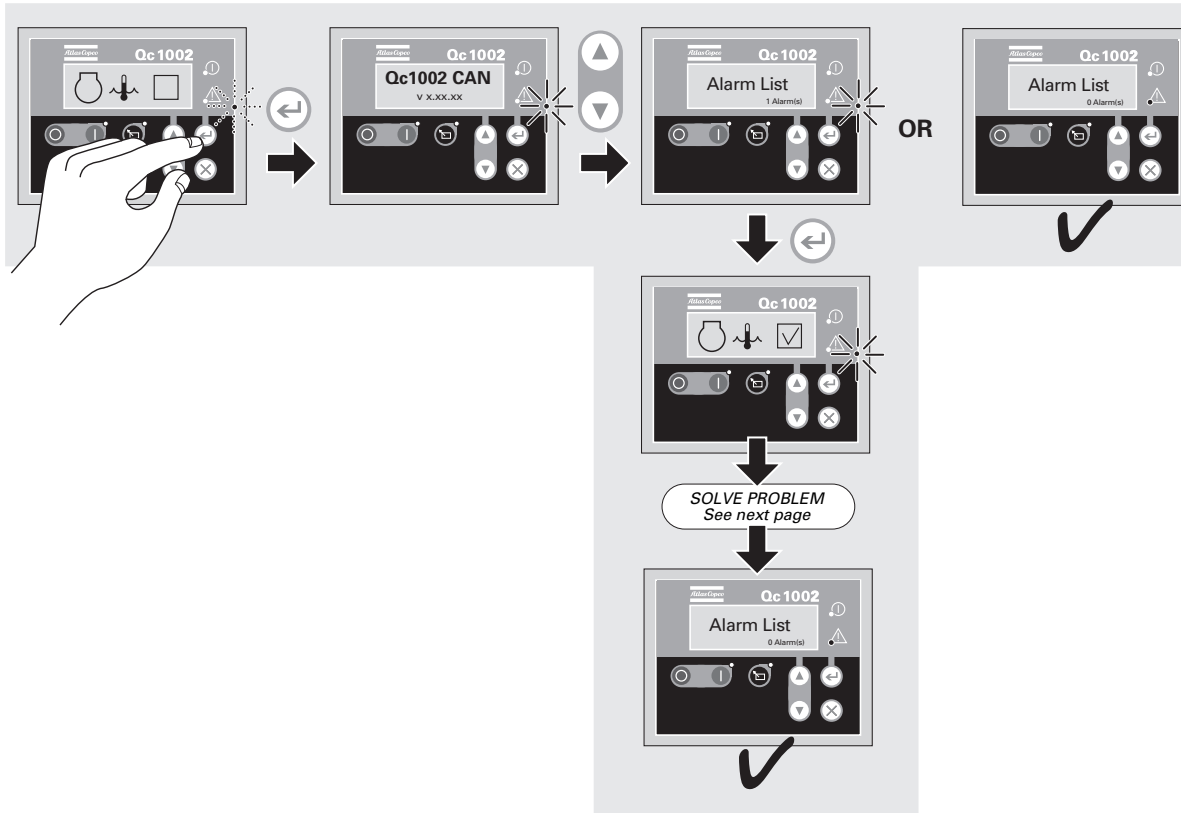

Menu flow

This is the described menu flow for solving alarms:



Solving problems

The troubleshooting table below shows how to solve problems causing controller alarms. It uses three common problems as an example.

<i>Alarm display</i>	<i>Symptom</i>	<i>Possible cause</i>	<i>Corrective action</i>
	<i>High coolant temperature</i>	Sensor broken	Replace sensor.
		Not enough coolant	Fill coolant till appropriate level. Check for leaks.
		Obstructed airflow	Check air inlets / outlet. Clean radiator.
	<i>Low battery voltage</i>	Battery drained	Charge battery. Install battery charger (depending on situation).
		Charging alternator broken	Measure battery voltage during running. Replace charging alternator if battery voltage is not OK.
		Battery broken	Replace battery.
	<i>Low oil pressure</i>	Bad connection	Check wiring.
		Not enough oil	Fill oil till appropriate level. Check for leaks.
		Sensor broken	Replace sensor.
		Oil sump broken	Check or contact Atlas Copco.
		Bad connection	Check wiring.

6.4.2 Qc1103™ and Qc2103™ alarms and remedies

6.4.2.1 Alarm handling

When an alarm occurs, the unit will automatically go to the alarm list and display the alarm. The alarm LED will be flashing.

If reading of the alarms is not desired, use the **BACK** push button to exit the alarm list. To enter the alarm list later, press the **RESET HORN** push button for 2 seconds to jump directly to the alarm list reading.

The alarm list contains both acknowledged and unacknowledged alarms, provided that they are still active (i.e. the alarm condition is still present). Once an alarm is acknowledged and the condition has disappeared, the alarm will no longer be displayed in the alarm list. This means that if there are no alarms, the alarm list will be empty.

This display example below indicates an unacknowledged alarm. The display can show only one alarm at a time. Therefore, all other alarms are hidden.

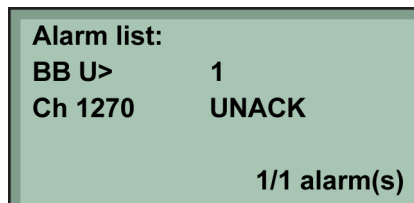

To see the other alarms, use the **UP** and **DOWN** push buttons to scroll in the display.

To acknowledge an alarm press the **ENTER** button.

6.4.2.2 Fail classes

All the activated alarms of the module are configured with a fail class. The fail class defines the category of the alarm and the subsequent action. A fail class can be selected for each alarm function either via the display or the PC software.

7 different fail classes can be used:

Engine running:

- **Block:** Alarm Horn Relay, Alarm Display.
- **Warning:** Alarm Horn Relay, Alarm Display.
- **Trip of GB:** Alarm Horn Relay, Alarm Display, GB Trip.
- **Trip & Stop:** Alarm Horn Relay, Alarm Display, GB Trip, Genset cooling down, Genset stop.
- **Shutdown:** Alarm Horn Relay, Alarm Display, GB Trip, Genset stop.
- **Trip of MB:** Alarm Horn Relay, Alarm Display, MB Trip.
- **Trip of MB/GB:** Alarm Horn Relay, Alarm Display, (GB Trip), MB Trip.

Engine stopped:

- **Block:** Block engine start.
- **Warning:** -
- **Trip of GB:** Block engine start, Block GB sequence.
- **Trip & Stop:** Block engine start, Block GB sequence.
- **Shutdown:** Block engine start, Block GB sequence.
- **Trip of MB:** Block MB sequence.
- **Trip of MB/GB:** (Block engine start), Block MB sequence, (Block GB sequence).

In order to select when the alarms are to be active, a configurable inhibit setting for each alarm has been made. The inhibit functionality is only available via the PARUS software

6.4.2.3 Solving alarms

This is the described menu flow for solving alarms:

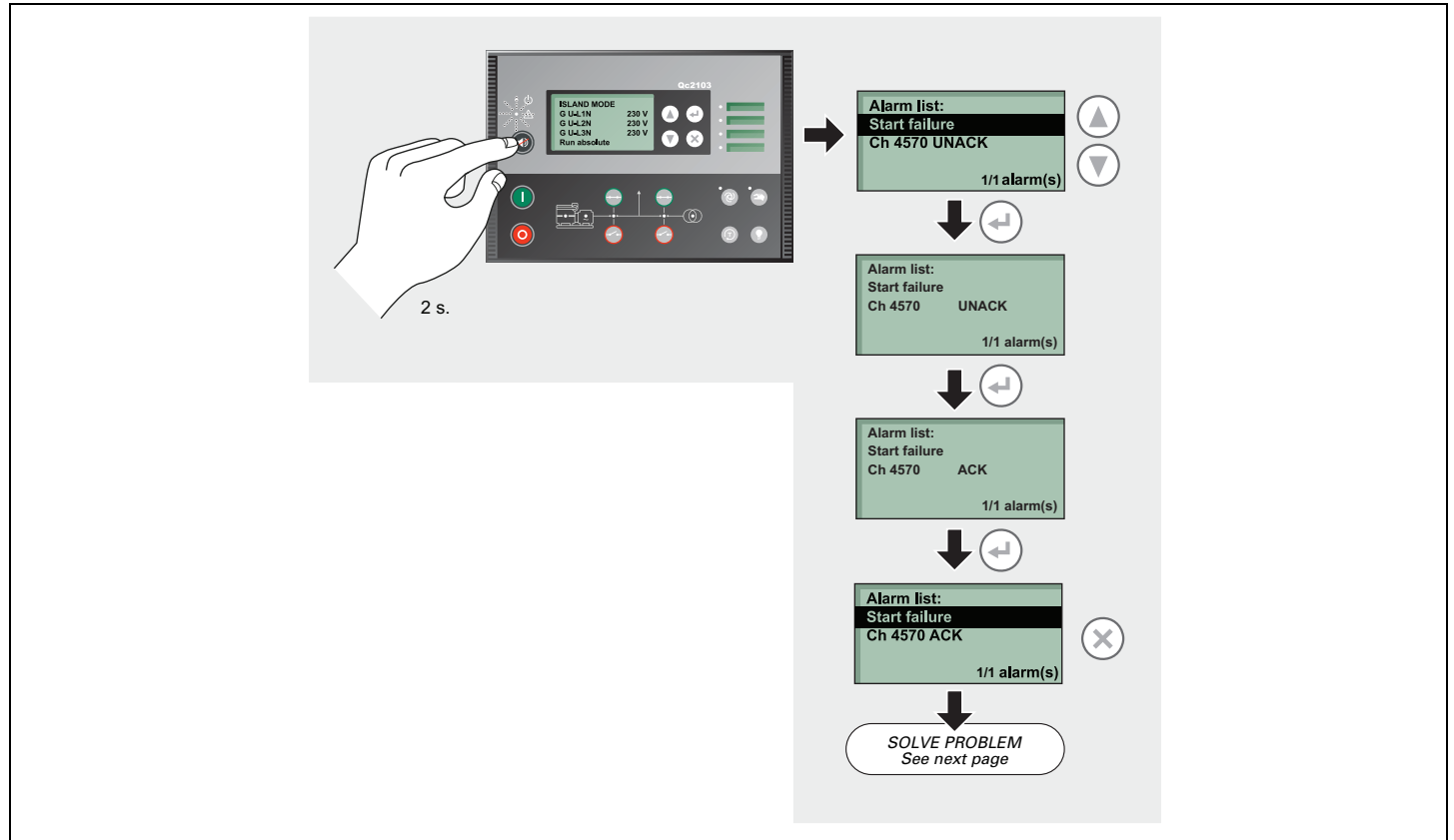

Solving problems

The troubleshooting table below shows how to solve problems causing controller alarms. It uses two common problems as an example.

<i>Alarm display</i>	<i>Symptom</i>	<i>Possible cause</i>	<i>Corrective action</i>
<div style="border: 1px solid black; padding: 5px; background-color: #e0f2f1;"> Alarm list: EIC Coolant T.1 Ch 7610 UNACK 1/1 alarm(s) </div>	<i>High coolant temperature</i>	Sensor broken	Replace sensor.
		Not enough coolant	Fill coolant till appropriate level. Check for leaks.
		Obstructed airflow	Check air inlets / outlet. Clean radiator.
		Bad connection	Check wiring.
<div style="border: 1px solid black; padding: 5px; background-color: #e0f2f1;"> Alarm list: EIC Oil pres. 1 Ch 7630 UNACK 1/1 alarm(s) </div>	<i>Low oil pressure</i>	Not enough oil	Fill oil till appropriate level. Check for leaks.
		Sensor broken	Replace sensor.
		Oil sump broken	Check or contact Atlas Copco.
		Bad connection	Check wiring.

6.4.3 Qc4002™ MkII alarms and remedies

6.4.3.1 Fail Classes

All the activated alarms of the module are configured with a fail class. The fail class defines the category of the alarm and the subsequent action.

6 different fail classes can be used:

Engine running:

- **Alarm:** Alarm Horn Relay, Alarm Display.
- **Warning:** Alarm Horn Relay, Alarm Display.
- **Trip of GB:** Alarm Horn Relay, Alarm Display, GB Trip.
- **Trip & Stop:** Alarm Horn Relay, Alarm Display, (Deload), GB Trip, Genset cooling down, Genset stop.
- **Shutdown:** Alarm Horn Relay, Alarm Display, GB Trip, Genset stop.
- **Trip of MB:** Alarm Horn Relay, Alarm Display, MB Trip.

Engine stopped:

- **Alarm:** Block engine start.
- **Warning:** -
- **Trip of GB:** Block engine start, Block GB sequence.
- **Trip & Stop:** Block engine start, Block GB sequence.
- **Shutdown:** Block engine start, Block GB sequence.
- **Trip of MB:** Block MB sequence.

All alarms can be disabled or enabled as following:

- **OFF:** disabled alarm, inactive supervision.
- **ON:** enabled alarm.

6.4.3.2 Diagnostics menu

The diagnostics menu can be entered via channel 6700. It is used for engine diagnostics situations.

If diagnostics is selected in this menu, the fuel solenoid relay output will be de-energized for 30 seconds (to make sure that the unit is completely stopped), and then gets energized again. Then engine diagnostics can take place.

To leave this status, disable diagnostics in channel 6700, or press stop, or start the machine (not during the first 30 s).



It's only possible to start the generator when Normal is selected.

6.4.3.3 Solving alarms

Menu flow

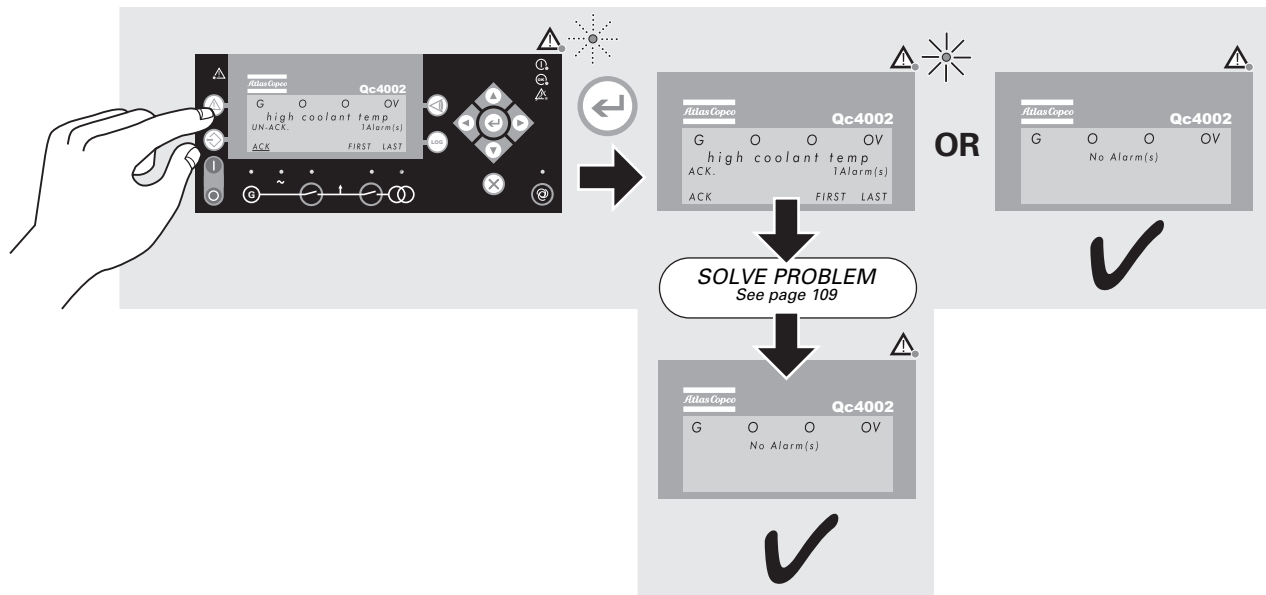

7 Storage of the generator

7.1 Storage

- Store the generator in a dry, frost-free room which is well ventilated.
- Run the engine regularly, e.g. once a week, until it is warmed up. If this is impossible, extra precautions must be taken:
 - Consult the engine's operator manual.
 - Remove the battery. Store it in a dry, frost-free room. Keep the battery clean and its terminals lightly covered with petroleum jelly. Recharge the battery regularly.
 - Clean the generator and protect all electrical components against moisture.
 - Place silica gel bags, VCI paper (Volatile Corrosion Inhibitor) or another drying agent inside the generator and close the doors.
 - Stick sheets of VCI paper with adhesive tape on the bodywork to close off all openings.
 - Wrap the generator, except the bottom, with a plastic bag.

7.2 Preparing for operation after storage

Before operating the generator again, remove the wrapping, VCI paper and silica gel bags and check the generator thoroughly (go through the checklist "Before starting" on page 28).

- Consult the engine's operator manual.
- Check that the insulation resistance of the generator exceeds 5 MΩ.
- Replace the fuel filter and fill the fuel tank. Vent the fuel system.
- Reinstall and connect the battery, if necessary after being recharged.
- Submit the generator to a test run.

8 Disposal

8.1 General

When developing products and services, Atlas Copco tries to understand, address, and minimize the negative environmental effects that the products and services may have, when being manufactured, distributed, and used, as well as at their disposal.

Recycling and disposal policy are part of the development of all Atlas Copco products. Atlas Copco company standards determine strict requirements.

Selecting materials the substantial recyclability, the disassembly possibilities and the separability of materials and assemblies are considered as well as the environmental perils and dangers to health during the recycling and disposal of the unavoidable rates of not recyclable materials.

Your Atlas Copco generator consists for the most part of metallic materials, that can be remelted in steelworks and smelting works and that is therefore almost infinite recyclable. The plastic used is labelled; sorting and fractioning of the materials for recycling in the future is foreseen.



This concept can only succeed with your help. Support us by disposing professionally. By assuring a correct disposal of the product you help to prevent possible negative consequences for environment and health, that can occur with an inappropriate waste handling.

Recycling and re-usage of material helps to preserve natural resources.

8.2 Disposal of materials

Dispose contaminated substances and material separately, according to local applicable environmental legislation.

Before dismantling a machine at the end of its operating lifetime drain all fluids and dispose of according the applicable local disposal regulations.

Remove the batteries. Do not throw batteries into the fire (explosion risk) or into the residual waste. Separate the machine into metal, electronics, wiring, hoses, insulation and plastic parts.

Dispose all components according to the applicable disposal regulations.

Remove spilled fluid mechanically; pick up the rest with absorbing agent (for example sand, sawdust) and dispose it according the applicable local disposal regulations. Do not drain into the sewage system or surface water.

9 Options available for QAS 80-100 units

9.1 Circuit diagrams

The engine control circuit diagrams and the power circuit diagrams for the standard QAS 80-100 units, for the units with options and for the units with combined options are:

Controller circuit

<i>Unit</i>	<i>Circuit</i>
QAS 80-100 Pd Qc1002™	9822 0996 15
QAS 80-100 Pd Qc2002™	9822 0996 16
QAS 80-100 Pd Qc1103™	1636 0037 70
	1636 0040 48
QAS 80-100 Pd Qc2103™	1636 0037 76
QAS 80-100 Pd Qc4002™ MkII	1636 0040 25

Power circuit

<i>Unit</i>	<i>Circuit</i>
QAS 80-100 Pd	1636 0038 55
QAS 80-100 Pd - 2V	1636 0040 29
QAS 80-100 Pd - MV	1636 0040 41
QAS 80-100 Pd - NW	1636 0040 36
QAS 80-100 Pd Qc4002™ MkII	1636 0040 25

9.2 Overview of the electrical options

The following electrical options are available:

- Automatic battery charger
- Battery switch
- Engine coolant heater
- Outlet sockets (S) - Set 1
- Outlet sockets (S) - Set 2
- Outlet sockets (S) - Set 3 QAS 80
- Outlet sockets (S) - Set 3 QAS 100
- Dual frequency (DF)
- Dual voltage (2V)
- Earth leakage relay
- IT-relay
- “Electricité de France” (EDF)
- COSMOS™
- Power Transfer Box (PTB)

9.3 Description of the electrical options



The positioning of the components mentioned in the description of the QAS 80-100 options, may differ slightly depending on the generator model.

9.3.1 Automatic battery charger

The automatic battery charger charges the battery completely and is disconnected once the unit starts up.

Besides the output terminals (secondary side) the automatic battery charger has a trim potentiometer for setting of the output voltage. By means of an insulated slotted screwdriver or adjusting pin the output voltage can be set in the range.

Setting:

- Lower output voltage = counter clockwise rotation
- Higher output voltage = clockwise rotation

The LED on the front indicates that the unit is operational.

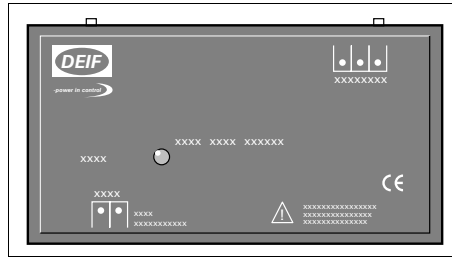

To use the battery charger:

- Provide the X25 connector, located at the side of the power cubicle, with external power to use the battery charger.

9.3.2 Battery switch

The battery switch is situated inside the sound-insulated bodywork. It allows to open or to close the electrical connection between the battery and the engine circuits.



Never turn the battery switch to OFF during operation.

9.3.3 Engine coolant heater

To make sure that the engine can start and accept load immediately, an external cooling water heater (1000 W, 240 V) is provided which keeps the engine temperature between 38°C and 49°C.

9.3.4 Outlet sockets (S) - Set 1

A brief description of all outlet sockets and circuit breakers provided on the generator is given hereafter:

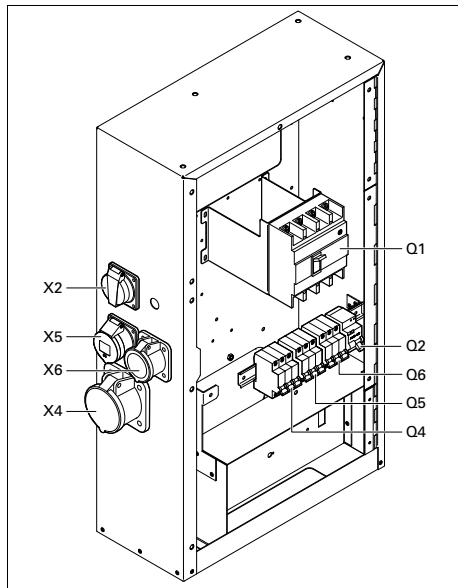

X2..... 1-phase outlet socket (230 V AC)

Provides phase L3, neutral and earthing.

X4..... 3-phase outlet socket (400 V AC)

Provides phases L1, L2 and L3, neutral and earthing.

X5..... 3-phase outlet socket (400 V AC)

Provides phases L1, L2 and L3, neutral and earthing.

X6..... 3-phase outlet socket (400 V AC)

Provides phases L1, L2 and L3, neutral and earthing.

Q2..... Circuit breaker for X2

Interrupts the power supply to X2 when a short-circuit occurs at the load side, or when the overcurrent protection (16 A) is activated. When tripped, Q2 interrupts phase L3 and the neutral towards X2. It can be reset after eliminating the problem.

Q4..... Circuit breaker for X4

Interrupts the power supply to X4 when a short-circuit occurs at the load side, or when the overcurrent protection (63 A) is activated. When tripped, Q4 interrupts the three phases towards X4. It can be reset after eliminating the problem.

Q5..... Circuit breaker for X5

Interrupts the power supply to X5 when a short-circuit occurs at the load side, or when the overcurrent protection (32 A) is activated. When tripped, Q5 interrupts the three phases towards X5. It can be reset after eliminating the problem.

Q6..... Circuit breaker for X6

Interrupts the power supply to X6 when a short-circuit occurs at the load side, or when the overcurrent protection (16 A) is activated. When tripped, Q6 interrupts the three phases towards X6. It can be reset after eliminating the problem.



Circuit breaker Q1 does not only interrupt the power supply towards X1, but also towards X2, X4, X5 and X6.

Make sure to switch on circuit breakers Q1, Q2, Q4, Q5 and Q6 after starting the generator when power is supplied by means of X2, X4, X5 or X6.

9.3.5 Outlet sockets (S) - Set 2

A brief description of all outlet sockets and circuit breakers provided on the generator is given hereafter:

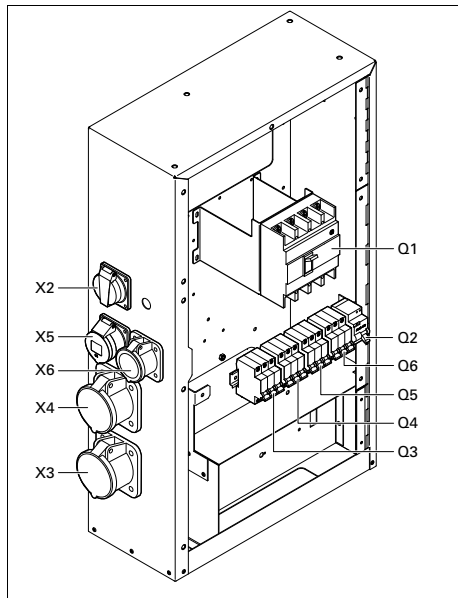

X2 1-phase outlet socket (230 V AC)

Provides phase L3, neutral and earthing.

X3 3-phase outlet socket (400 V AC)

Provides phases L1, L2 and L3, neutral and earthing.

X4 3-phase outlet socket (400 V AC)

Provides phases L1, L2 and L3, neutral and earthing.

X5 3-phase outlet socket (400 V AC)

Provides phases L1, L2 and L3, neutral and earthing.

X6 3-phase outlet socket (400 V AC)

Provides phases L1, L2 and L3, neutral and earthing.

Q2 Circuit breaker for X2

Interrupts the power supply to X2 when a short-circuit occurs at the load side, or when the overcurrent protection (16 A) is activated. When tripped, Q2 interrupts phase L3 and the neutral towards X2. It can be reset after eliminating the problem.

Q3 Circuit breaker for X3

Interrupts the power supply to X3 when a short-circuit occurs at the load side, or when the overcurrent protection (63 A) is activated. When tripped, Q3 interrupts the three phases towards X3. It can be reset after eliminating the problem.

Q4 Circuit breaker for X4

Interrupts the power supply to X4 when a short-circuit occurs at the load side, or when the overcurrent protection (63 A) is activated. When tripped, Q4 interrupts the

three phases towards X4. It can be reset after eliminating the problem.

Q5 Circuit breaker for X5

Interrupts the power supply to X5 when a short-circuit occurs at the load side, or when the overcurrent protection (32 A) is activated. When tripped, Q5 interrupts the three phases towards X5. It can be reset after eliminating the problem.

Q6 Circuit breaker for X6

Interrupts the power supply to X6 when a short-circuit occurs at the load side, or when the overcurrent protection (16 A) is activated. When tripped, Q6 interrupts the three phases towards X6. It can be reset after eliminating the problem.



Circuit breaker Q1 does not only interrupt the power supply towards X1, but also towards X2, X3, X4, X5 and X6.

Make sure to switch on circuit breakers Q1, Q2, Q3, Q4, Q5 and Q6 after starting the generator when power is supplied by means of X2, X3, X4, X5 or X6.

9.3.6 Outlet sockets (S) - Set 3 QAS 80

A brief description of all outlet sockets and circuit breakers provided on the generator is given hereafter:

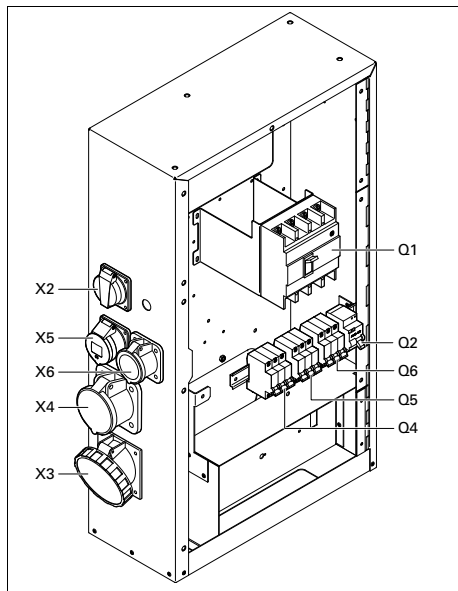

X2 1-phase outlet socket (230 V AC)

Provides phase L3, neutral and earthing.

X3 3-phase outlet socket (400 V AC)

Provides phases L1, L2 and L3, neutral and earthing.

X4 3-phase outlet socket (400 V AC)

Provides phases L1, L2 and L3, neutral and earthing.

X5 3-phase outlet socket (400 V AC)

Provides phases L1, L2 and L3, neutral and earthing.

X6 3-phase outlet socket (400 V AC)

Provides phases L1, L2 and L3, neutral and earthing.

Q2 Circuit breaker for X2

Interrupts the power supply to X2 when a short-circuit occurs at the load side, or when the overcurrent protection (16 A) is activated. When tripped, Q2 interrupts phase L3 and the neutral towards X2. It can be reset after eliminating the problem.

Q4 Circuit breaker for X4

Interrupts the power supply to X4 when a short-circuit occurs at the load side, or when the overcurrent protection (63 A) is activated. When tripped, Q4 interrupts the three phases towards X4. It can be reset after eliminating the problem.

Q5 Circuit breaker for X5

Interrupts the power supply to X5 when a short-circuit occurs at the load side, or when the overcurrent protection (32 A) is activated. When tripped, Q5 interrupts the three phases towards X5. It can be reset after eliminating the problem.

Q6 Circuit breaker for X6

Interrupts the power supply to X6 when a short-circuit occurs at the load side, or when the overcurrent protection (16 A) is activated. When tripped, Q6 interrupts the three phases towards X6. It can be reset after eliminating the problem.



Circuit breaker Q1 does not only interrupt the power supply towards X1, but also towards X2, X3, X4, X5 and X6.

Make sure to switch on circuit breakers Q1, Q2, Q4, Q5 and Q6 after starting the generator when power is supplied by means of X2, X3, X4, X5 or X6.

9.3.7 Outlet sockets (S) - Set 3 QAS 100

A brief description of all outlet sockets and circuit breakers provided on the generator is given hereafter:

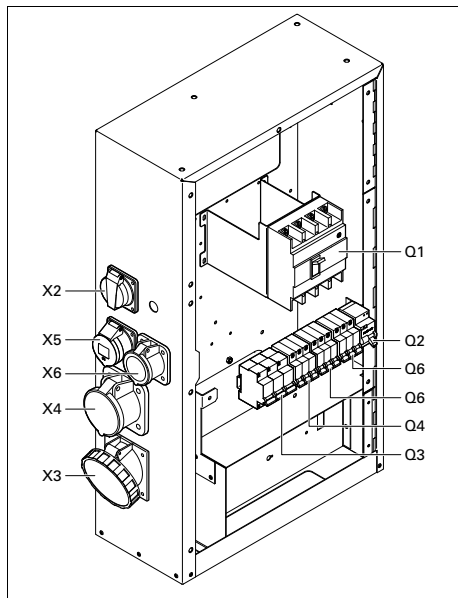

X2 1-phase outlet socket (230 V AC)

Provides phase L3, neutral and earthing.

X3 3-phase outlet socket (400 V AC)

Provides phases L1, L2 and L3, neutral and earthing.

X4 3-phase outlet socket (400 V AC)

Provides phases L1, L2 and L3, neutral and earthing.

X5 3-phase outlet socket (400 V AC)

Provides phases L1, L2 and L3, neutral and earthing.

X6 3-phase outlet socket (400 V AC)

Provides phases L1, L2 and L3, neutral and earthing.

Q2 Circuit breaker for X2

Interrupts the power supply to X2 when a short-circuit occurs at the load side, or when the overcurrent protection (16 A) is activated. When tripped, Q2 interrupts phase L3 and the neutral towards X2. It can be reset after eliminating the problem.

Q3 Circuit breaker for X3

Interrupts the power supply to X3 when a short-circuit occurs at the load side, or when the overcurrent protection (125 A) is activated. When tripped, Q3 interrupts the three phases towards X3. It can be reset after eliminating the problem.

Q4 Circuit breaker for X4

Interrupts the power supply to X4 when a short-circuit occurs at the load side, or when the overcurrent protection (63 A) is activated. When tripped, Q4 interrupts the

three phases towards X4. It can be reset after eliminating the problem.

Q5 Circuit breaker for X5

Interrupts the power supply to X5 when a short-circuit occurs at the load side, or when the overcurrent protection (32 A) is activated. When tripped, Q5 interrupts the three phases towards X5. It can be reset after eliminating the problem.

Q6 Circuit breaker for X6

Interrupts the power supply to X6 when a short-circuit occurs at the load side, or when the overcurrent protection (16 A) is activated. When tripped, Q6 interrupts the three phases towards X6. It can be reset after eliminating the problem.



Circuit breaker Q1 does not only interrupt the power supply towards X1, but also towards X2, X3, X4, X5 and X6.

Make sure to switch on circuit breakers Q1, Q2, Q3, Q4, Q5 and Q6 after starting the generator when power is supplied by means of X2, X3, X4, X5 or X6.

9.3.8 Dual frequency (DF)

The Dual frequency option allows the unit to work at 50 Hz or at 60 Hz at constant load. The frequency selection is done by means of switch S12.

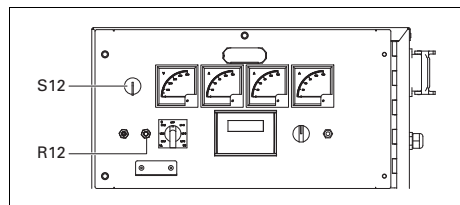

R12 *Voltage adjustment*

Allows to adjust the output voltage.

S12 *Frequency selector switch (50 Hz/ 60 Hz)*

Allows to choose the frequency of the output voltage: 50 Hz or 60 Hz.



Changing the output frequency is only allowed when the unit has stopped.

After changing the output frequency, adjust the output voltage by means of potentiometer R12 to the required value.

9.3.9 Dual voltage (2V)



The dual voltage option is only available on 50 Hz units with Qc1002™ controller.

1 phase - 3 phase

The generator can run in two different modes:

1 phase, lower voltage

When using this selection, the generator provides a 230 V output voltage.

3 phase, higher voltage

When using this selection, the generator provides a 400 V output voltage.

3 phase - 3 phase

The generator can run in two different modes:

3 phase, lower voltage

When using this selection, the generator provides a 230 V output voltage. (IT = active)

3 phase, higher voltage

When using this selection, the generator provides a 400 V output voltage. (ELR = active)

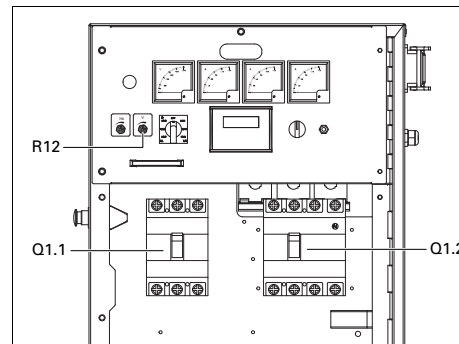

Q1.1 *Circuit breaker for low voltage, high current*

Interrupts the low voltage power supply towards X1 when a short-circuit occurs at the load side or when the overcurrent protection (1 phase - 3 phase: QAS 80: 250 A, QAS 100: 280 A / 3 phase - 3 phase: QAS 80: 200 A, QAS 100: 250 A) is activated. It must be reset manually after eliminating the problem.

Q1.2....Circuit breaker for high voltage, low current

Interrupts the high voltage power supply towards X1 when a short-circuit occurs at the load side or when the overcurrent protection (QAS 80: 125 A, QAS 100: 144 A) is activated. It must be reset manually after eliminating the problem.

R12 Voltage adjustment

Allows to adjust the output voltage.



AMF operation is not possible with a dual voltage generator.

Depending on which mode the generator is running in, circuit breaker Q1.1 or Q1.2 will be operational.

Circuit breakers Q1.1 and Q1.2 cannot be switched on at the same time. This is prevented by means of the auxiliary voltage selection relays K11 and K12 (refer to circuit diagram 1636 0040 41/00) or S10b and S10c (refer to circuit diagram 1636 0040 29/00).

The selection between the two modes is done by means of S10.

S10 Output voltage selection switch

Allows to select a 3 phase high output voltage or a 1 phase / 3 phase low output voltage. Selector switch S10 is located on the alternator.



Changing the output voltage is only allowed when the unit has stopped.

After changing the output voltage by means of the selection switch S10, adjust the output voltage by means of potentiometer R12 to the required value.

9.3.10 Earth leakage relay

The Earth relay option provides a detector that will trip the main circuit breaker Q1 when an earth fault current is detected.

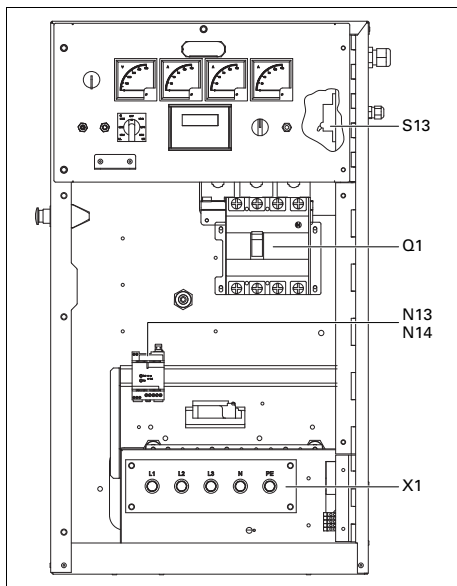

Q1.....Main circuit breaker

N13.....Earth leak detector

Detects and indicates an earth fault current and activates the main circuit breaker Q1. The detection level can be set at 30 mA fixed with instantaneous trip but can also be adjusted between 0.1 A and 1 A with time delayed (0 - 0.5 sec) trip. N13 has to be reset manually after eliminating the problem (reset button marked R). It can be overridden by means of the earth leak switch (S13, labelled IΔN) but has to be tested monthly by pushing test button T13.

S13Lock-out switch for earth fault protection (N13)

This switch is located inside the cubicle and is labelled IΔN.

Position O: No tripping of the main circuit breaker Q1 when an earth fault occurs.

Position 1: Tripping of the main circuit breaker Q1 when an earth fault occurs.



Position O will only be used in conjunction with an external earth fault protection unit (e.g. integrated in a distribution board).

If S13 is in position O, proper earthing is of the utmost importance for the safety of the user. Eliminating any earth fault protection can lead to serious injury or even death for anybody touching the unit or the load.

9.3.11 IT-relay

The generator is wired for an IT network i.e. no supply lines of the power supply are directly earthed. A failure in insulation resulting in a too low insulation resistance, is detected by the insulation monitoring relay.



The generator shall not be operated with other networks (such as TT or TN). Doing so will cause tripping of the insulation monitoring relay.

The generator is wired for an IT network i.e. no supply lines of the power supply are directly earthed. A failure in insulation resulting in too low an insulation resistance, is detected by the insulation monitoring relay.

At each start-up and any time a new load is connected, the insulation resistance must be verified. Check for the correct setting of the insulation monitoring relay (factory set at 13 k Ω).

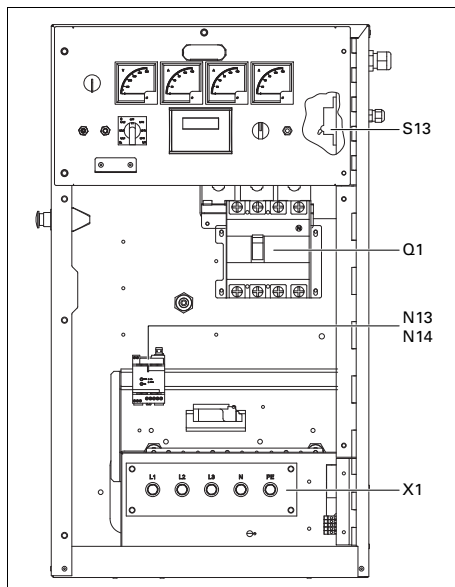

Q1 Circuit breaker for X1

Interrupts the power supply X1 when a short-circuit occurs at the load side, or when the overcurrent protection is activated. When activated, Q1 interrupts the three phases towards X1. It must be reset manually after eliminating the problem.

X1 Main power supply (400 Vac)

Terminals L1, L2, L3, N (= neutral) and PE (= earthing), hidden behind the control panel door and behind a small transparent door.

N14 Insulation monitoring relay

Checks the insulation resistance and activates Q1 when the insulation resistance is too low.

S2 Emergency stop button

Push the button to stop the generator in case of an emergency. When the button is pressed, it must be unlocked, by turning it anti-clockwise, before the generator can be restarted. The emergency stop button can be secured in the locked position with the key, to avoid unauthorized use.

9.3.12 “Electricité de France” (EDF)

When the EDF-option is installed, the unit operates as a standard unit when the neutral and the PE terminals are connected to each other (see figure below). In this case, an earth leakage at the side of the generator or at the side of the load will switch off the circuit breaker.

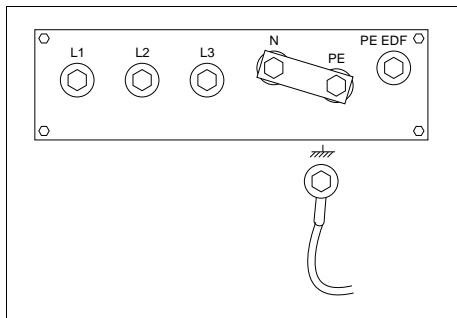

When EDF-option is installed, the unit operates as EDF-unit when the earthing, the PE and the PE EDF terminals are connected to each other (see figure below). In this case, an earth leakage at the side of the generator will switch off the circuit breaker. An earth leakage at the side of the load will not switch off the circuit breaker.

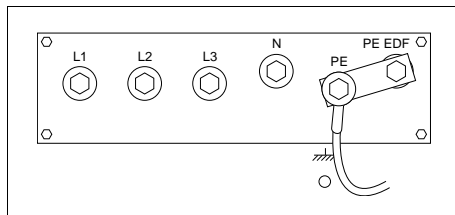

Changing the operation mode from standard unit to EDF-unit or vice versa has to be carried out by a qualified person from “Electricité de France”.

9.3.13 COSMOS™

COSMOS™ is a web-based global remote monitoring system that electronically tracks every aspect of equipment from its location to its operating parameters. The Cosmos system can send e-mails or SMS messages to the contractor or owner in real time, with all critical and non-critical events and data involving your compressors and generators. It allows optimal servicing.

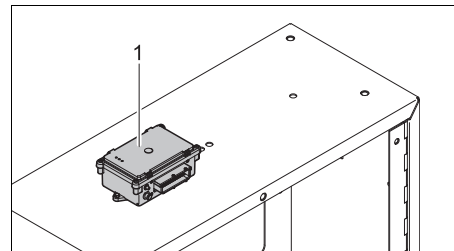

If no LEDs light up when the generator is running, the Cosmos module (1) has not been installed correctly. Consult the Cosmos manual for a description of LED indications.

For information about COSMOS™, consult your local Atlas Copco dealer.

9.3.14 Power Transfer Box (PTB)



The PTB (Power Transfer Box) is only available in combination with the Qc2002™ and Qc2103™ control panel.

When operating the Qc2002™/Qc2103™ control panel in AMF mode, the installation of a PTB is required.

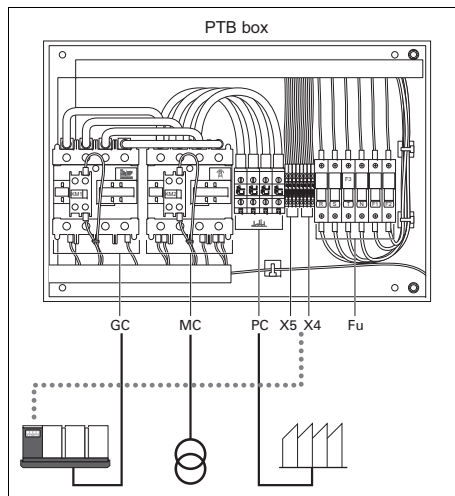

Fu.....Fuses F1, F2, F3

GC..... Generator contactor

MC..... Mains contactor

PCPlant contactor (generator contactor)

*X5...Customer connections Contactor
Operation*

To connect PTB customer connection X5 to the generator equipped with Qc2002™/Qc2103™ controller, 4 connections have to be made on generator customer terminal strip X25. Connect GB to GB, MB to MB.

X4..... Customer connections Mains Sensing

To connect PTB customer connection X4 to the generator equipped with Qc2002™/Qc2103™ controller, 4 connections have to be made on generator terminal strip X25. Connect N to N, R to R, S to S, T to T.

9.4 Overview of the mechanical options

The following mechanical options are available:

- External fuel tank connection (with/without quick couplings)
- Undercarriage (axle, towbar, towing eyes)
- Skid fuel tank
- Integrated spark arrester
- Air inlet shut-off valve

9.5 Description of the mechanical options

9.5.1 External fuel tank connection (with/without quick couplings)

The option external fuel tank connection allows to bypass the internal fuel tank and to connect an external fuel tank to the unit.

View outside

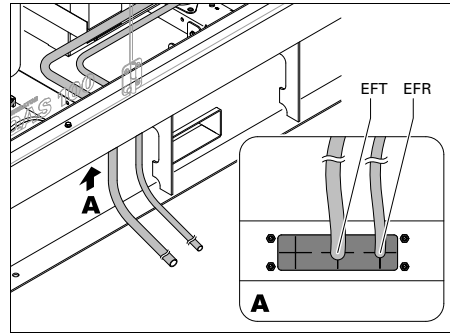

View inside

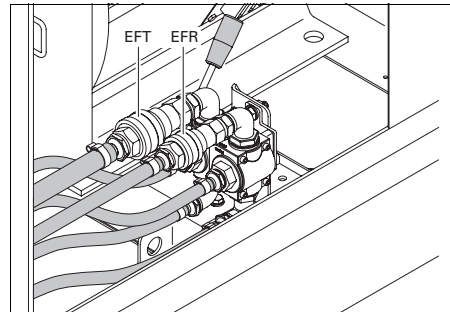

EFT | External fuel tank feed connection
EFR | External fuel tank return connection

When using this option, make sure to connect the fuel supply line as well as the fuel return line. Connections to fuel lines ought to be air-tight to prevent air from entering the fuel system. Turn the handle of 3-way valve to desired condition.



Position 1: Indicates that the fuel supply line to the engine is connected to the internal fuel tank.

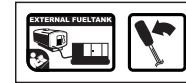

Position 2: Indicates that the fuel supply line to the engine is connected to the external fuel tank.

9.5.2 Undercarriage (axle, towbar, towing eyes)

The undercarriage is equipped with an adjustable towbar with brakes, with BNA-, NATO-, DIN-, ITA-, ISO-eye and Ball coupling and with road signalisation which is approved by EC legislation.

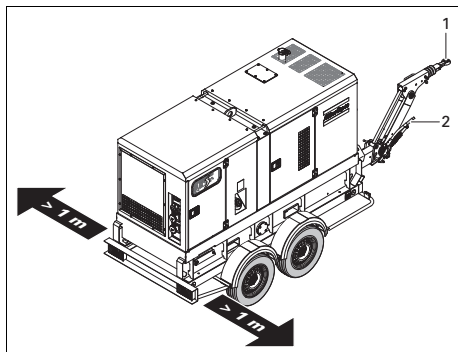

When using this option

- Make sure that the towing equipment of the vehicle matches the towing eye (1) before towing the generator.
- Never move the generator while electrical cables are connected to the unit.
- Always apply the hand brake (2) when parking the generator.
- Leave enough space for operation, inspection and maintenance (at least 1 meter at each side).

To maintain the undercarriage

- Check the tightness of the towbar bolts, the axle bolts and the wheel nuts at least twice a year and after the initial 50 hours of operation.
- Grease the wheel axle suspension bearings, the drawbar to the steering gear shaft and the spindle of the brake handle at least twice a year. Use ball bearing grease for the wheel bearings and graphite grease for the drawbar and spindle.
- Check the brake system twice a year.
- Check the condition of the vibration dampers twice a year.
- Repack the wheel hub bearings once a year using grease.
- Wheel chocks allows to park the generator on sloping ground. Place wheel chocks in front of or behind the wheels to immobilize the generator.

9.5.3 Integrated spark arrestor

The integrated spark arrestor option is included in the refinery equipment pack.

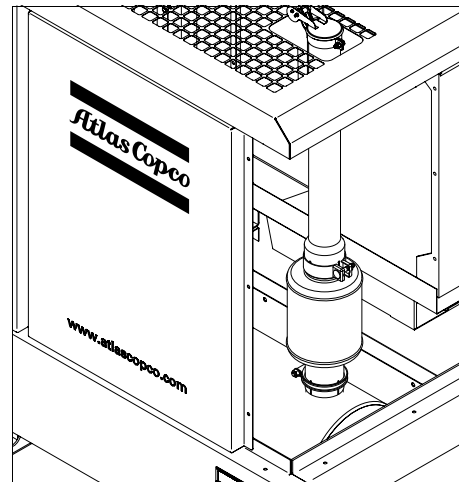

9.5.4 Air inlet shut-off valve

The engine air inlet shut-off valve option is included in the refinery equipment pack. It will prevent over-speeding of the engine due to combustible gases being traced within the normal engine air intake.

10 Technical specifications

10.1 Technical specifications for QAS 80 units

10.1.1 Readings on gauges

<i>Gauge</i>	<i>Reading</i>	<i>Unit</i>
Ammeter L1-L3 (P1-P3)	Below max. rating	A
Voltmeter (P4)	Below max. rating	V

10.1.2 Settings of safeties

<i>Safety</i>	<i>Function</i>	<i>Activates at</i>
Engine coolant temperature	Warning	107°C
Engine coolant temperature	Shut down	112°C

10.1.3 Specifications of the engine/alternator/unit

		<i>50 Hz</i>	<i>60 Hz</i>
<i>Reference conditions</i> 1) 4)	Rated frequency	50 Hz	60 Hz
	Rated speed	1500 rpm	1800 rpm
	Generator service duty	PRP	PRP
	Absolute air inlet pressure	1 bar(a)	1 bar(a)
	Relative air humidity	30%	30%
	Air inlet temperature	25°C	25°C
<i>Limitations</i> 2)	Maximum ambient temperature	50°C	50°C
	Altitude capability	4000 m	4000 m
	Maximum relative air humidity	85%	85%
	Minimum starting temperature	-15°C	-15°C
	Minimum starting temperature with cold start equipment (optional)	-25°C	-25°C
<i>Performance data</i> 2) 3) 4) 5)	Rated active power (PRP) 3ph	64 kW	74.4 kW
	Rated active power (PRP) 1ph	48 kW	53 kW

Rated power factor (lagging) 3ph	0.8 cos ϕ	0.8 cos ϕ
Rated power factor (lagging) 1ph	1 cos ϕ	1 cos ϕ
Rated apparent power (PRP) 3ph	80 kVA	93 kVA
Rated apparent power (PRP) 1ph	48 kVA	53 kVA
Rated voltage 3ph line to line	400 V	480 V
Rated voltage 3ph line to line lower voltage	230 V	240 V
Rated voltage 1ph	230 V	240 V
Rated current 3ph	115.5 A	111.9 A
Rated current 3ph lower voltage	200.8 A	223.7 A
Rated current 1ph	208.7 A	220.8 A
Performance class (acc. ISO 8528-5:1993)	G2	G2
Single step load acceptance	90%	100%
	57.6 kW	74.4 kW
Frequency droop	isochronous	isochronous
Fuel consumption at no load (0%)	2.2 kg/h	2.9 kg/h
Fuel consumption at 50% load	8.5 kg/h	11.5 kg/h
Fuel consumption at 75% load	12.3 kg/h	15.6 kg/h
Fuel consumption at full load (100%)	16.3 kg/h	19.6 kg/h
Specific fuel consumption at full load (100%)	0.247 kg/kWh	0.256 kg/kWh
Fuel autonomy at full load with standard tank	12.1 h	10.1 h
Fuel autonomy at full load with optional skid fuel tank	28.8 h	23.9 h
Max. oil consumption at full load	0.028 l/h	0.034 l/h
Maximum sound power level (Lw) complies with 2000/14/EC	92 dB(A)	95 dB(A)
Capacity of fuel tank	230 l	230 l
Capacity of optional skid fuel tank	545 l	545 l
Single step load capability	100%	100%
	64 kW	74.4 kW
<i>Application data</i>		
Mode of operation	PRP	PRP
Site	land use	land use
Operation	single/parallel	single/parallel
Start-up and control mode	manual/automatic	manual/automatic
Start-up time	unspecified	unspecified
Mobility/Config. acc. to ISO 8528-1:1993	transportable/D	transportable/D

	(optional)	mobile/E	mobile/E
	Mounting	fully resilient	fully resilient
	Climatic exposure	open air	open air
	Status of neutral (TT or NT)	earthed	earthed
	Status of neutral (IT) (optional)	insulated	insulated
<i>Engine 4)</i>	Standard	ISO 3046	ISO 3046
	Type PERKINS	ISO 8528-2	ISO 8528-2
	Rated net output	1104D-E44TAG1	1104D-E44TAG1
	rating type acc. ISO 3046-7	56.3 kW	60.0 kW
	Coolant	ICXN	ICXN
	Combustion system	coolant	coolant
	Aspiration	direct injection	direct injection
	Charged air cooling system	turbo charged	turbo charged
	Number of cylinders	intercooled	intercooled
	Swept volume	4	4
	Speed governing	4.41 l	4.41 l
	Governor type	electronic	electronic
	Capacity of oil sump (initial fill)	ECM	ECM
	Capacity of cooling system	8.5 l	8.5 l
	Electrical system	17 l	17 l
	Emission compliance	12 Vdc	12 Vdc
	Maximum permissible load factor of PRP during 24h period	EU stage IIIA	EU stage IIIA
		80%	80%
<i>Alternator 4)</i>	Standard	IEC34-1	IEC34-1
	Make	ISO 8528-3	ISO 8528-3
	Model	Leroy Somer	Leroy Somer
	Rated output, class H temperature rise	LSA43.2 L8	LSA43.2 L8
	rating type acc. ISO 8528-3	80 kVA	95 kVA
	Degree of protection (IP index acc. NF EN 60-529)	BR 125/40°C	BR 125/40°C
	Insulation stator class	IP 23	IP 23
	Insulation rotor class	H	H
	Number of wires	H	H
		12	12

Power circuit

Circuit-breaker, 3ph.

Number of poles
Thermal release I_t (thermal release is higher at 25°C)
Magnetic release I_m

4
125 A
3.5x I_n

4
125 A
3.5x I_n

Circuit-breaker, 3ph., lower voltage

Number of poles (optional)
Thermal release I_t (thermal release is higher at 25°C)
Magnetic release I_m

3
200 A
3.5x I_n

4
225 A
3.5x I_n

Circuit-breaker, 1ph.

Number of poles (optional)
Thermal release I_t (thermal release is higher at 25°C)
Magnetic release I_m

3
250 A
3.5x I_n

4
250 A
3.5x I_n

Fault current protection

Residual current release I_{Dn}
Insulation resistance (optional)

0.03-30 A
10-100 kOhm

0.03-30 A
10-100 kOhm

Outlet sockets (optional)

Following three socket configuration is possible:

1. i + ii + iii + iv
2. i + ii + iii + iv (2x)
3. i + ii + iii + iv + v

i) domestic
2p + PE
16 A/230 V

ii) CEE form
3p + N + PE
16 A/400 V

iii) CEE form
3p + N + PE
32 A/400 V

iv) CEE form
3p + N + PE
63 A/400 V

Unit

	v) CEE form	
	3p + N + PE	
	125 A/400 V	
Dimensions without undercarriage (LxWxH)	2850 x 1100 x 1635 mm	2850 x 1100 x 1635 mm
Dimensions without undercarriage, with optional 24h fuel tank (LxWxH)	2850 x 1100 x 1751 mm	2850 x 1100 x 1751 mm
Dimensions with undercarriage (adj. towbar, DIN eye) (LxWxH)	5019 x 1665 x 2201 mm	5019 x 1665 x 2201 mm
Dimensions with undercarriage (fixed towbar, DIN eye) (LxWxH)	4780 x 1665 x 2201 mm	4780 x 1665 x 2201 mm
Weight net mass - without undercarriage	1780 kg	1780 kg
Weight wet mass - without undercarriage	1994 kg	1994 kg
Weight net mass - without undercarriage, with optional 24h fuel tank	1846 kg	1846 kg
Weight wet mass - without undercarriage, with optional 24h fuel tank	2366 kg	2366 kg
Weight net mass - with undercarriage	2175 kg	2175 kg
Weight wet mass - with undercarriage	2399 kg	2399 kg

Notes

- 1) Reference conditions for engine performance to ISO 3046-1.
- 2) See derating diagram below or consult the factory for other conditions.
- 3) At reference conditions unless otherwise stated.
- 4) Rating definition (ISO 8528-1):
LTP: Limited Time Power is the maximum electrical power which a generating set is capable of delivering (at variable load), in the event of a utility power failure (for up to 500 hours per year of which a maximum of 300 hours is continuous running). No overload is permitted on these ratings. The alternator is peak continuous rated (as defined in ISO 8528-3) at 25°C.
PRP: Prime Power is the maximum power available during a variable power sequence, which may be run for an unlimited number of hours per year, between stated maintenance intervals and under the stated ambient conditions. A 10% overload is permitted for 1 hour in 12 hours. The permissible average power output during a 24h period shall not exceed the stated load factor as indicated in the 'Technical specifications' above.
- 5) Specific mass fuel used: 0.86 kg/l.

Derating factor (%)
- 50 Hz

Height (m)	Temperature (°C)										
	0	5	10	15	20	25	30	35	40	45	50
0	100	100	100	100	100	100	100	100	100	95	90
500	100	100	100	100	100	100	100	100	100	95	90
1000	100	100	100	100	100	100	100	100	100	95	90
1500	100	100	100	100	95	95	95	95	95	90	85
2000	95	95	95	95	95	95	90	90	90	85	80
2500	90	90	90	90	90	90	85	85	85	NA	NA
3000	90	90	90	90	90	90	85	85	85	NA	NA
3500	80	80	80	80	80	80	80	NA	NA	NA	NA
4000	80	80	80	80	80	80	80	NA	NA	NA	NA

Derating factor (%)
- 60 Hz

Height (m)	Temperature (°C)										
	0	5	10	15	20	25	30	35	40	45	50
0	100	100	100	100	100	100	100	100	100	95	90
500	100	100	100	100	100	100	100	100	100	95	90
1000	100	100	100	100	100	100	100	100	100	95	90
1500	100	100	100	100	95	95	95	95	95	90	85
2000	95	95	95	95	95	95	90	90	90	85	80
2500	90	90	90	90	90	90	85	85	85	NA	NA
3000	90	90	90	90	90	90	85	85	85	NA	NA
3500	80	80	80	80	80	80	80	NA	NA	NA	NA
4000	80	80	80	80	80	80	80	NA	NA	NA	NA

For use of generator outside these conditions, please contact Atlas Copco.

10.2 Technical specifications for QAS 100 units

10.2.1 Readings on gauges

<i>Gauge</i>	<i>Reading</i>	<i>Unit</i>
Ammeter L1-L3 (P1-P3)	Below max. rating	A
Voltmeter (P4)	Below max. rating	V

10.2.2 Settings of safeties

<i>Safety</i>	<i>Function</i>	<i>Activates at</i>
Engine coolant temperature	Warning	107°C
Engine coolant temperature	Shut down	112°C

10.2.3 Specifications of the engine/alternator/unit

		<i>50 Hz</i>	<i>60 Hz</i>
<i>Reference conditions</i> 1) 4)	Rated frequency	50 Hz	60 Hz
	Rated speed	1500 rpm	1800 rpm
	Generator service duty	PRP	PRP
	Absolute air inlet pressure	1 bar(a)	1 bar(a)
	Relative air humidity	30%	30%
	Air inlet temperature	25°C	25°C
<i>Limitations</i> 2)	Maximum ambient temperature	50°C	50°C
	Altitude capability	4000 m	4000 m
	Maximum relative air humidity	85%	85%
	Minimum starting temperature	-15°C	-15°C
	Minimum starting temperature with cold start equipment (optional)	-25°C	-25°C
<i>Performance data</i> 2) 3) 4) 5)	Rated active power (PRP) 3ph	80 kW	90.4 kW
	Rated active power (PRP) 1ph	66 kW	74 kW
	Rated power factor (lagging) 3ph	0.8 cos ϕ	0.8 cos ϕ
	Rated power factor (lagging) 1ph	1 cos ϕ	1 cos ϕ

Rated apparent power (PRP) 3ph	100 kVA	113 kVA
Rated apparent power (PRP) 1ph	66 kVA	74 kVA
Rated voltage 3ph line to line	400 V	480 V
Rated voltage 3ph line to line lower voltage	230 V	240 V
Rated voltage 1ph	230 V	240 V
Rated current 3ph	144.3 A	135.9 A
Rated current 3ph lower voltage	251.0 A	271.8 A
Rated current 1ph	287.0 A	308.3 A
Performance class (acc.ISO 8528-5:1993)	G2	G2
Single step load acceptance	80%	85%
	64.0 kW	76.8 kW
Frequency droop	isochronous	isochronous
Fuel consumption at no load (0%)	2.2 kg/h	3.1 kg/h
Fuel consumption at 50% load	10.7 kg/h	13.9 kg/h
Fuel consumption at 75% load	15.2 kg/h	18.6 kg/h
Fuel consumption at full load (100%)	19.8 kg/h	23.0 kg/h
Specific fuel consumption at full load (100%)	0.241 kg/kWh	0.246 kg/kWh
Fuel autonomy at full load with standard tank	10 h	8.6 h
Fuel autonomy at full load with optional skid fuel tank	23.6 h	20.4 h
Max. oil consumption at full load	0.035 l/h	0.040 l/h
Maximum sound power level (Lw) complies with 2000/14/EC	92 dB(A)	95 dB(A)
Capacity of fuel tank	230 l	230 l
Capacity of optional skid fuel tank	545 l	545 l
Single step load capability	100%	100%
	80 kW	90.4 kW
<i>Application data</i>		
Mode of operation	PRP	PRP
Site	land use	land use
Operation	single/parallel	single/parallel
Start-up and control mode	manual/automatic	manual/automatic
Start-up time	unspecified	unspecified
Mobility/Config. acc. to ISO 8528-1:1993	transportable/D	transportable/D
(optional)	mobile/E	mobile/E
Mounting	fully resilient	fully resilient

<i>Engine 4)</i>	Climatic exposure	open air	open air
	Status of neutral (TT or NT)	earthed	earthed
	Status of neutral (IT) (optional)	insulated	insulated
	Standard	ISO 3046	ISO 3046
	Type PERKINS	ISO 8528-2	ISO 8528-2
	Rated net output	1104D-E44TAG2	1104D-E44TAG2
	rating type acc. ISO 3046-7	88.6 kW	100.0 kW
	Coolant	ICXN	ICXN
	Combustion system	coolant	coolant
	Aspiration	direct injection	direct injection
	Charged air cooling system	turbo charged	turbo charged
	Number of cylinders	intercooled	intercooled
	Swept volume	4	4
	Speed governing	4.41 l	4.41 l
	Governor type	electronic	electronic
	Capacity of oil sump (initial fill)	ECM	ECM
	Capacity of cooling system	8.5 l	8.5 l
Electrical system	17.0 l	17.0 l	
Emission compliance	12 Vdc	12 Vdc	
Maximum permissible load factor of PRP during 24h period	EU stage IIIa	EU stage IIIa	
	80%	80%	
<i>Alternator 4)</i>	Standard	IEC34-1	IEC34-1
	Make	ISO 8528-3	ISO 8528-3
	Model	Leroy Somer	Leroy Somer
	Rated output, class H temperature rise	LSA44.2 VS45	LSA44.2 VS45
	rating type acc. ISO 8528-3	105 kVA	131 kVA
	Degree of protection (IP index acc. NF EN 60-529)	BR 125/40°C	BR 125/40°C
	Insulation stator class	IP 23	IP 23
	Insulation rotor class	H	H
	Number of wires	H	H
		12	12

Power circuit

Circuit-breaker, 3ph.

Number of poles

4

4

Thermal release I_t (thermal release is higher at 25°C)

144 A

144 A

Magnetic release I_m

3..5x I_n

3..5x I_n

Circuit-breaker, 3ph., lower voltage

Number of poles (optional)

3

4

Thermal release I_t (thermal release is higher at 25°C)

252 A

280 A

Magnetic release I_m

3..5x I_n

3..5x I_n

Circuit-breaker, 1ph.

Number of poles (optional)

3

4

Thermal release I_t (thermal release is higher at 25°C)

280 A

280 A

Magnetic release I_m

3..5x I_n

3..5x I_n

Fault current protection

Residual current release I_{Dn}

0.030-30 A

0.030-30 A

Insulation resistance (optional)

10-100 kOhm

10-100 kOhm

Outlet sockets (optional)

Following three socket configuration is possible:

1. i + ii + iii + iv

i) domestic
2p + PE
16 A/230 V

2. i + ii + iii + iv (2x)

ii) CEE form
3p + N + PE
16 A/400 V

3. i + ii + iii + iv + v

iii) CEE form
3p + N + PE
32 A/400 V

iv) CEE form
3p + N + PE
63 A/400 V

Unit

	v) CEE form	
	3p + N + PE	
	125 A/400 V	
Dimensions without undercarriage (LxWxH)	2850 x 1100 x 1635 mm	2850 x 1100 x 1635 mm
Dimensions without undercarriage, with optional 24h fuel tank (LxWxH)	2850 x 1100 x 1751 mm	2850 x 1100 x 1751 mm
Dimensions with undercarriage (adj. towbar, DIN eye) (LxWxH)	5019 x 1665 x 2201 mm	5019 x 1665 x 2201 mm
Dimensions with undercarriage (fixed towbar, DIN eye) (LxWxH)	4780 x 1665 x 2201 mm	4780 x 1665 x 2201 mm
Weight net mass - without undercarriage	1796 kg	1796 kg
Weight wet mass - without undercarriage	2010 kg	2010 kg
Weight net mass - without undercarriage, with optional 24h fuel tank	1862 kg	1862 kg
Weight wet mass - without undercarriage, with optional 24h fuel tank	2382 kg	2382 kg
Weight net mass - with undercarriage	2180 kg	2180 kg
Weight wet mass - with undercarriage	2394 kg	2394 kg

Notes

- 1) Reference conditions for engine performance to ISO 3046-1.
- 2) See derating diagram below or consult the factory for other conditions.
- 3) At reference conditions unless otherwise stated.
- 4) Rating definition (ISO 8528-1):
LTP: Limited Time Power is the maximum electrical power which a generating set is capable of delivering (at variable load), in the event of a utility power failure (for up to 500 hours per year of which a maximum of 300 hours is continuous running). No overload is permitted on these ratings. The alternator is peak continuous rated (as defined in ISO 8528-3) at 25°C.
PRP: Prime Power is the maximum power available during a variable power sequence, which may be run for an unlimited number of hours per year, between stated maintenance intervals and under the stated ambient conditions. A 10% overload is permitted for 1 hour in 12 hours. The permissible average power output during a 24h period shall not exceed the stated load factor as indicated in the 'Technical specifications' above.
- 5) Specific mass fuel used: 0.86 kg/l.

Derating factor (%)
- 50 Hz

Height (m)	Temperature (°C)										
	0	5	10	15	20	25	30	35	40	45	50
0	100	100	100	100	100	100	100	100	100	95	85
500	100	100	100	100	100	100	95	95	95	90	85
1000	95	95	90	90	90	90	90	85	85	85	80
1500	90	90	90	90	90	90	85	85	85	80	80
2000	90	90	90	90	90	90	90	90	90	80	80
2500	90	90	90	90	90	80	80	85	85	NA	NA
3000	80	80	80	75	75	75	75	75	75	NA	NA
3500	80	80	75	75	75	75	75	NA	NA	NA	NA
4000	70	70	70	70	70	65	65	NA	NA	NA	NA

Derating factor (%)
- 60 Hz

Height (m)	Temperature (°C)										
	0	5	10	15	20	25	30	35	40	45	50
0	100	100	100	100	100	100	100	100	100	95	90
500	100	100	100	100	100	100	95	95	95	95	90
1000	100	100	100	100	100	95	95	95	95	95	85
1500	100	100	100	100	95	95	95	95	95	85	85
2000	100	100	95	95	95	95	95	90	90	80	80
2500	100	100	95	95	95	95	95	90	90	NA	NA
3000	95	95	95	90	90	90	90	90	90	NA	NA
3500	85	85	85	85	85	80	80	NA	NA	NA	NA
4000	80	80	80	75	75	75	75	NA	NA	NA	NA

For use of generator outside these conditions, please contact Atlas Copco.

10.3 Conversion list of SI units into British units

1 bar	=	14.504 psi
1 g	=	0.035 oz
1 kg	=	2.205 lbs
1 km/h	=	0.621 mile/h
1 kW	=	1.341 hp (UK and US)
1 l	=	0.264 US gal
1 l	=	0.220 imp gal (UK)
1 l	=	0.035 cu.ft
1 m	=	3.281 ft
1 mm	=	0.039 in
1 m ³ /min	=	35.315 cfm
1 mbar	=	0.401 in wc
1 N	=	0.225 lbf
1 Nm	=	0.738 lbf.ft
$t_{°F}$	=	$32 + (1.8 \times t_{°C})$
$t_{°C}$	=	$(t_{°F} - 32)/1.8$

A temperature difference of 1°C = a temperature difference of 1.8°F.

10.4 Data plate

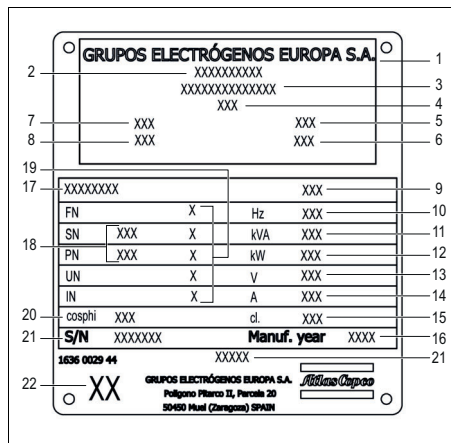

1. Name of manufacturer
2. EEC or national type approved number
3. Vehicle identification number
4. Maximum permitted total weight of the vehicle
5. Maximum permitted load on towing eye (fixed towbar)
6. Maximum permitted axle load (fixed towbar)
7. Maximum permitted load on towing eye (articulated towbar)
8. Maximum permitted axle load (articulated towbar)
9. Model number
10. Frequency
11. Apparent power - PRP
12. Active power - PRP
13. Nominal rated voltage
14. Nominal rated current
15. Generator class
16. Manufacturing year
17. Machine type
18. Mode of operation
19. Winding connections
20. Power factor
21. Serial number
22. EEC mark in accordance with Machine Directive 89/392E

Circuit diagrams

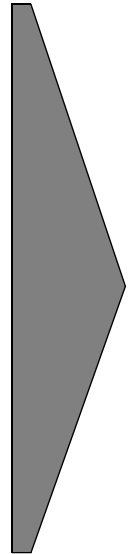

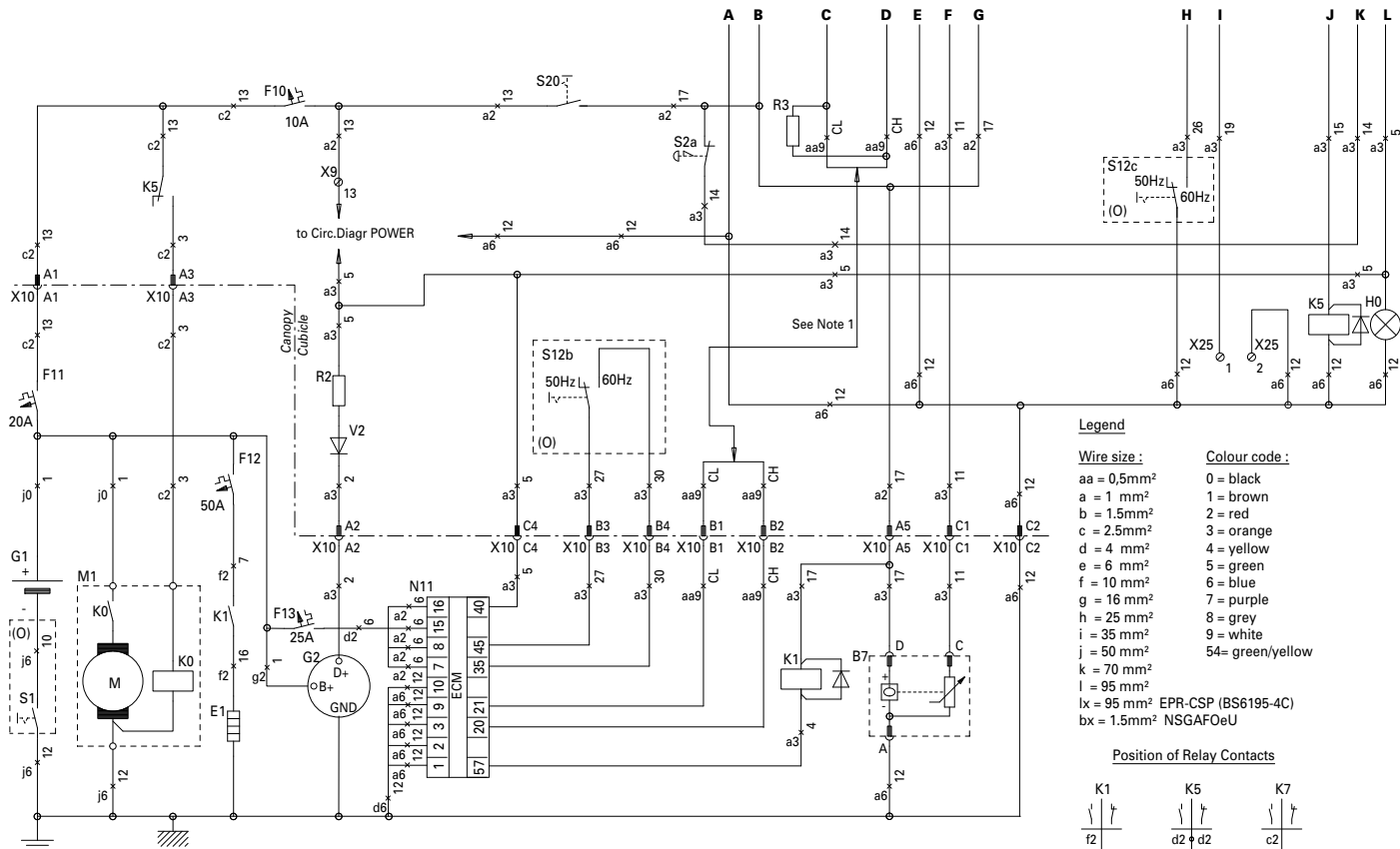

A1	Generator control unit (set A1 in UNIT-type X)	(O)	Optional equipment
B7	Fuel level sensor		
E1	Preheat resistor		
F10	Circuit breaker 10A		
F11	Fuse 20 A DC		
F12	Fuse 50 A DC		
F13	Fuse 25 A DC		
G1	Battery 12 Vdc		
G2	Charging alternator		
H0	Panel light		
K0	Starter solenoid		
K1	Preheat relay		
K5	Starter relay		
K7	Auxiliary relay for Y7 (O)		
M1	Starter motor		
N11	ECM		
P1-P3	A-meter		
P4	V-meter		
R2	Excitation resistor 47ohm		
R3	Resistor 120 ohm CAN-bus		
S1	Battery switch (O)		
S2a	Emergency stop (S2b: see Power circuit)		
S4	V-meter change-over switch		
S12b,c	Dual frequency switch (O) (S12a see Power Circuit)		
S20	ON/OFF switch		
V2	Excitation diode		
V7	Free-wheeling diode Y7 (O)		
X9	Terminal strip (O)		
X10	Connector wire harness		
X25	Customer's terminal strip		
Y7	Air inlet shutdown valve (O)		

9822 0996 16/02

Applicable for QAS 80-100 Pd - Engine Circuit Qc2002™

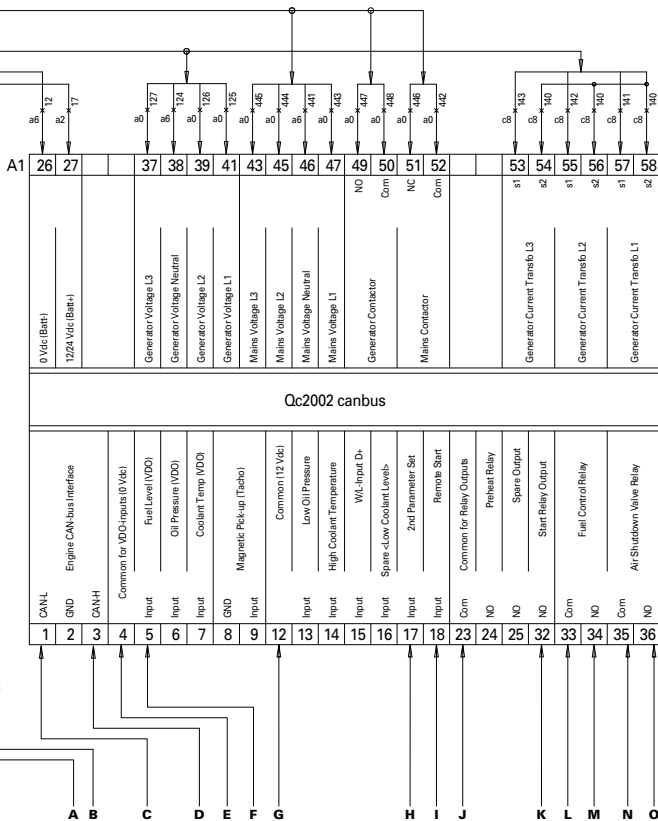
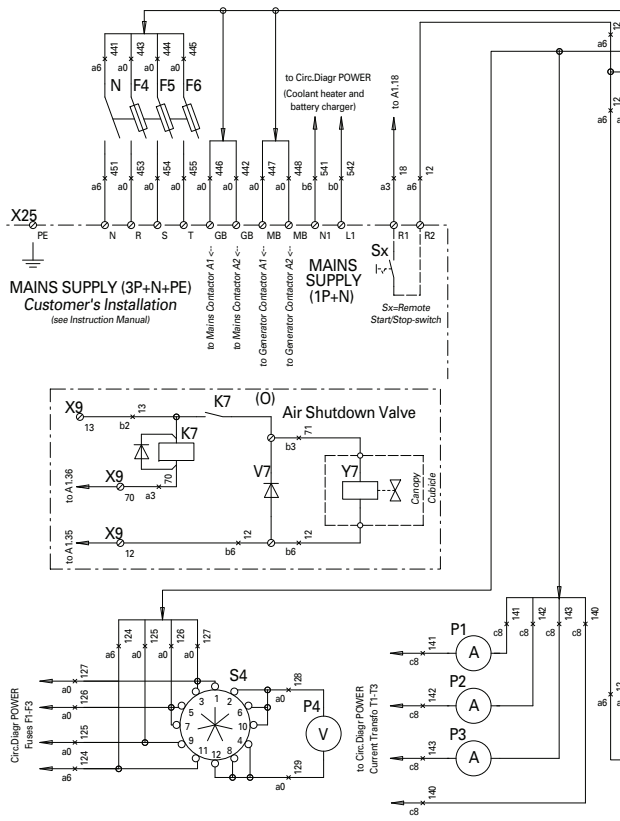

A1	Generator control unit	X25	Customer's terminal strip
B7	Fuel level sensor	Y7	Air inlet shutdown valve (O)
E1	Preheat resistor	(O)	Optional equipment
F4-6	Fuses 0.25A		
F10	Circuit breaker 10A		
F11	Fuse 20 A DC		
F12	Fuse 50 A DC		
F13	Fuse 25 A DC		
G1	Battery 12 Vdc		
G2	Charging alternator		
H0	Panel light		
K0	Starter solenoid		
K1	Preheat relay		
K5	Starter relay		
K7	Auxiliary relay for Y7 (O)		
M1	Starter motor		
N11	ECM		
P1-P3	A-meter		
P4	V-meter		
R2	Excitation resistor 47ohm		
R3	Resistor 120 ohm CAN-bus		
S1	Battery switch (O)		
S2a	Emergency stop		
	(S2b: see Power circuit)		
S4	V-meter change-over switch		
S12b,c	Dual frequency switch (O)		
	(S12a see Power Circuit)		
S20	ON/OFF switch		
V2	Excitation diode		
V7	Free-wheeling diode Y7 (O)		
X9	Terminal strip (O)		
X10	Connector wire harness		

1636 0037 70/00

Applicable for QAS 80-100 Pd - Engine Circuit Qc1103™

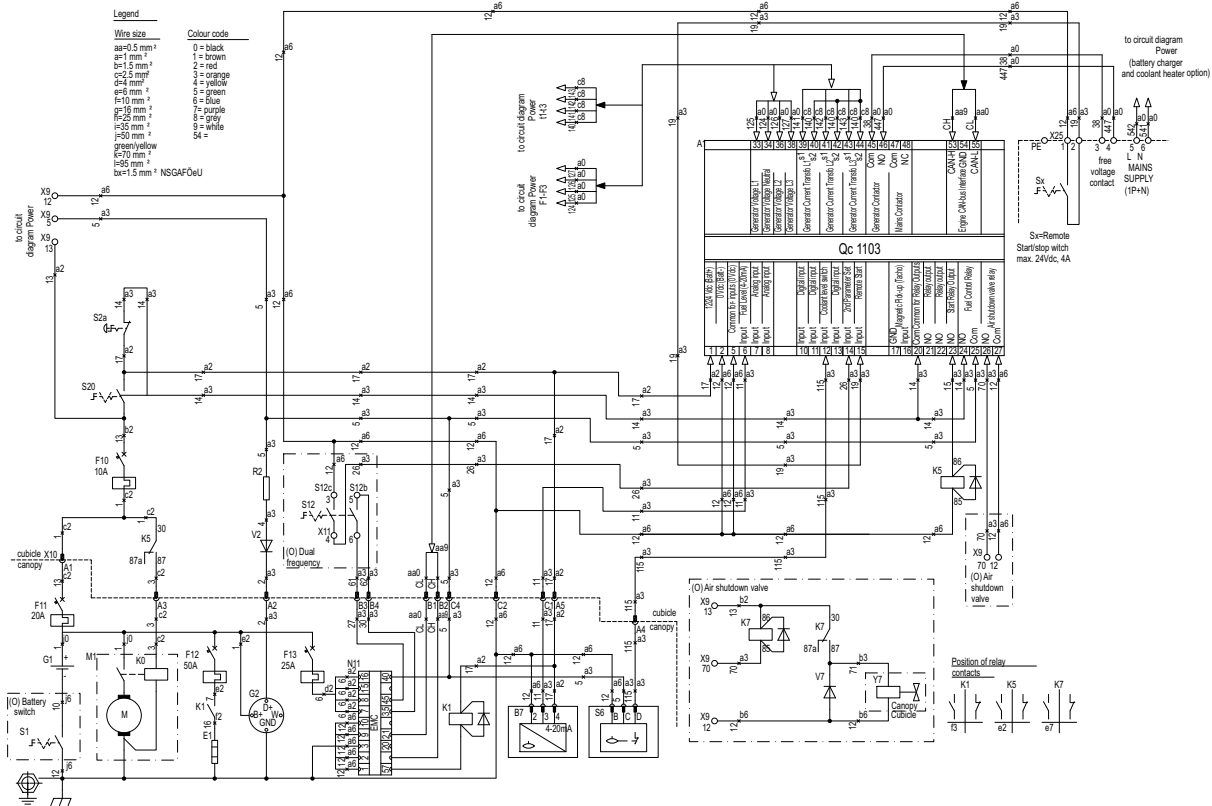

A1	Control module
B7	Fuel level sensor
E1	Preheat resistor
F10	Thermal circuit breaker 10A
F11	Fuse 20 A DC
F12	Fuse 50 A DC
F13	Fuse 25 A DC
G1	Battery 12 V
G2	Charging alternator
K0	Starter solenoid
K1	Preheat relay
K5	Starter relay
K7	Auxiliary relay for Y7 (O)
M1	Starter motor
N11	EMC
R2	Excitation resistor 47ohm
S1	Battery switch
S2a	Emergency stop button (S2b: see Power circuit)
S6	Coolant heater switch
S12b,c	Selector switch 50/60 Hz (S12a see Power Circuit)
S20	ON/OFF switch
V2	Excitation diode
V7	Free-wheeling diode Y7 (O)
X9	Terminal strip (see Power Circuit)
X10	15-pole connector
X11	Terminal strip (see Power Circuit)
X25	Terminal strip
Y7	Air shutdown valve (O)
(O)	Optional equipment

1636 0040 48/00

Applicable for QAS 80-100 Pd, dual voltage, Norwegian variant, multiple voltage - Engine Circuit Qc1103™

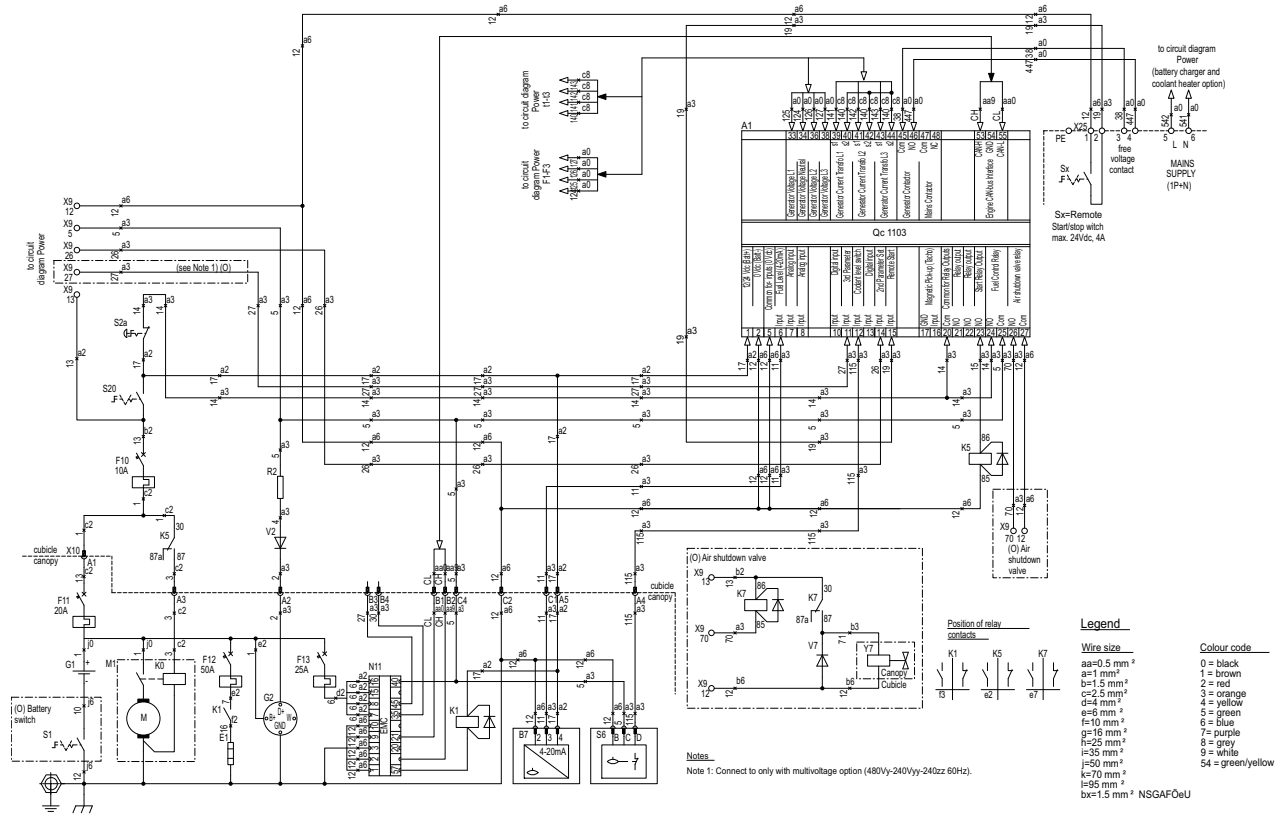

A1	Control module
B7	Fuel level sensor
E1	Preheat resistor
F10	Thermal circuit breaker 10A
F11	Fuse 20 A DC
F12	Fuse 50 A DC
F13	Fuse 25 A DC
G1	Battery 12 V
G2	Charging alternator
K0	Starter solenoid
K1	Preheat relay
K5	Starter relay
K7	Auxiliary relay for Y7 (O)
M1	Starter motor
N11	EMC
R2	Excitation resistor 47ohm
S1	Battery switch
S2a	Emergency stop button (S2b: see Power circuit)
S6	Coolant heater switch
S20	ON/OFF switch
V2	Excitation diode
V7	Free-wheeling diode Y7 (O)
X9	Terminal strip (see Power Circuit)
X10	15-pole connector
X11	Terminal strip (see Power Circuit)
X25	Terminal strip
Y7	Air shutdown valve (O)
(O)	Optional equipment

A1	Control module
B7	Fuel level sensor
E1	Preheat resistor
F4-6	Fuses 0.25A
F10	Thermal circuit breaker 10A
F11	Fuse 20 A DC
F12	Fuse 50 A DC
F13	Fuse 25 A DC
G1	Battery 12 V
G2	Charging alternator
K0	Starter solenoid
K1	Preheat relay
K5	Starter relay
K7	Auxiliary relay for Y7 (O)
M1	Starter motor
N11	EMC
R2	Excitation resistor 47ohm
S1	Battery switch
S2a	Emergency stop button (S2b: see Power circuit)
S6	Coolant heater switch
S12b,c	Selector switch 50/60 Hz (S12a see Power Circuit)
S20	ON/OFF switch
V2	Excitation diode
V7	Free-wheeling diode Y7 (O)
X9	Terminal strip (O) (see Power Circuit)
X10	15-pole connector
X11	Terminal strip (see Power Circuit)
X25	Terminal strip
Y7	Air shutdown valve (O)
(O)	Optional equipment

1636 0038 55/00_A

Applicable for QAS 80-100 Pd - Power Circuit

	Q1	T1-T3	Wire size	Wire size
QAS80	115A	150/5	X	Y
QAS100	144A	150/5	J	J

Settings N14
 response value $\frac{1}{2}$ (alarm $\frac{1}{2}$)
 100Chm
 fault memory M. On
 operating mode K1/K2: NO
 starting delay: t=1s
 response delay ton=6s
 password: off

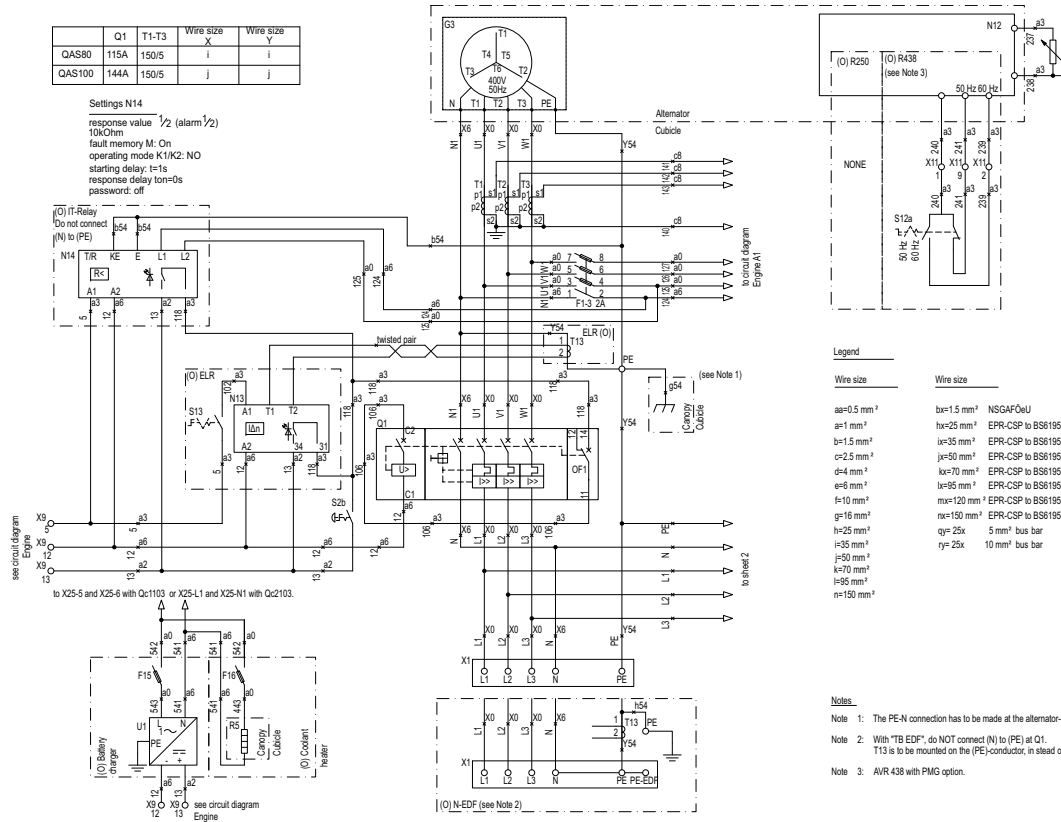

Legend

Wire size	Wire size	Colour code
aa=0.5 mm ²	bx=1.5 mm ² NSGAFoU	0 = black
a=1 mm ²	hx=25 mm ² EPR-CSP to BS61954C	1 = brown
a=1.5 mm ²	ix=35 mm ² EPR-CSP to BS61954C	2 = red
p=2.5 mm ²	jx=50 mm ² EPR-CSP to BS61954C	3 = orange
d=4 mm ²	kx=70 mm ² EPR-CSP to BS61954C	4 = yellow
e=6 mm ²	lx=95 mm ² EPR-CSP to BS61954C	5 = green
f=10 mm ²	mx=120 mm ² EPR-CSP to BS61954C	6 = blue
g=16 mm ²	nx=150 mm ² EPR-CSP to BS61954C	7= purple
h=25 mm ²	qy=25x 5 mm ² bus bar	8 = grey
i=35 mm ²	ry=25x 10 mm ² bus bar	9 = white
j=50 mm ²		54 = green/yellow
k=70 mm ²		
l=95 mm ²		
n=150 mm ²		

- Notes
- The PE-N connection has to be made at the alternator-side of main circuit breaker Q1.
 - With 'TB EDV', do NOT connect (N) to (PE) at Q1. T13 is to be mounted on the (PE) conductor, in stead of on PE-N connection in the cubicle.
 - AVR 438 with PMG option.

F1-3	Fuses 2A
F15	Fuse 6A (O)
F16	Fuse 6A (O)
G3	Alternator
N12	Automatic voltage regulator
N13	Earth leakage relay (O)
N14	Earth leakage relay (O)
Q1	Main circuit breaker
R5	Coolant heater
R12	Voltage adjustment potmeter
S2b	Emergency stop (S2a see engine circuit)
S12a	Selector switch 50/60Hz (O) (S12c, d see engine circuit)
S13	Earth relay lock-out switch (O)
T1-3	Current transformer
T13	Torus earth relay (O)
U1	Battery charger (O)
X1	Terminal board
X9	Terminal strip (see engine circuit)
X11	Terminal strip (see engine circuit)
(O)	Optional equipment

1636 0038 55/00_B

Applicable for QAS 80-100 Pd - Power Circuit

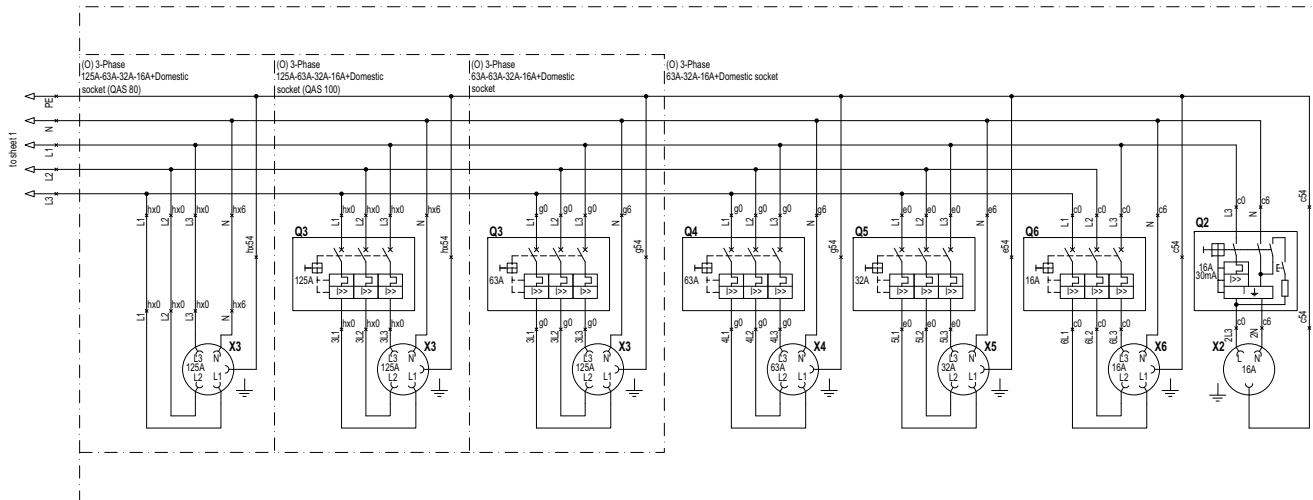

Legend

Wire size

- aa=0.5 mm² NSGAFOeU
- a=1 mm² EPR-CSP to BS61954C
- b=1.5 mm² EPR-CSP to BS61954C
- c=2.5 mm² EPR-CSP to BS61954C
- d=4 mm² EPR-CSP to BS61954C
- e=6 mm² EPR-CSP to BS61954C
- f=10 mm² EPR-CSP to BS61954C
- g=16 mm² EPR-CSP to BS61954C
- h=25 mm² bar
- i=35 mm² bar
- j=50 mm²
- k=70 mm²
- l=95 mm²
- n=150 mm²

Wire size

- bv=1.5 mm²
- hw=25 mm²
- ix=35 mm²
- ix=50 mm²
- kx=70 mm²
- lx=95 mm²
- mx=120 mm²
- nx=150 mm²
- qy=25x 5 mm² bus
- ry=25x 10 mm² bus

Colour code

- 0 = black
- 1 = brown
- 2 = red
- 3 = orange
- 4 = yellow
- 5 = green
- 6 = blue
- 7 = purple
- 8 = grey
- 9 = white
- 54 = green/yellow

Q2	Circuit Breaker 16A/30mA
Q3	Circuit Breaker 63A or 125A
Q4	Circuit Breaker 63A
Q5	Circuit Breaker 32A
Q6	Circuit Breaker 16A
X2	Outlet Socket 16A 1ph
X3	Outlet Socket 63A or 125A
X4	Outlet Socket 63A
X5	Outlet Socket 32A
X6	Outlet Socket 16A
(O)	Optional equipment

1636 0040 29/00

Applicable for QAS 80-100 Pd - Power Circuit, dual voltage

Settings N14
 response value $\sqrt{2}$ (alarm) $\sqrt{2}$
 10kOhm
 fault memory M: On
 operating mode K1/K2: NO
 starting delay: t=fs
 response delay ton=ts
 password: off

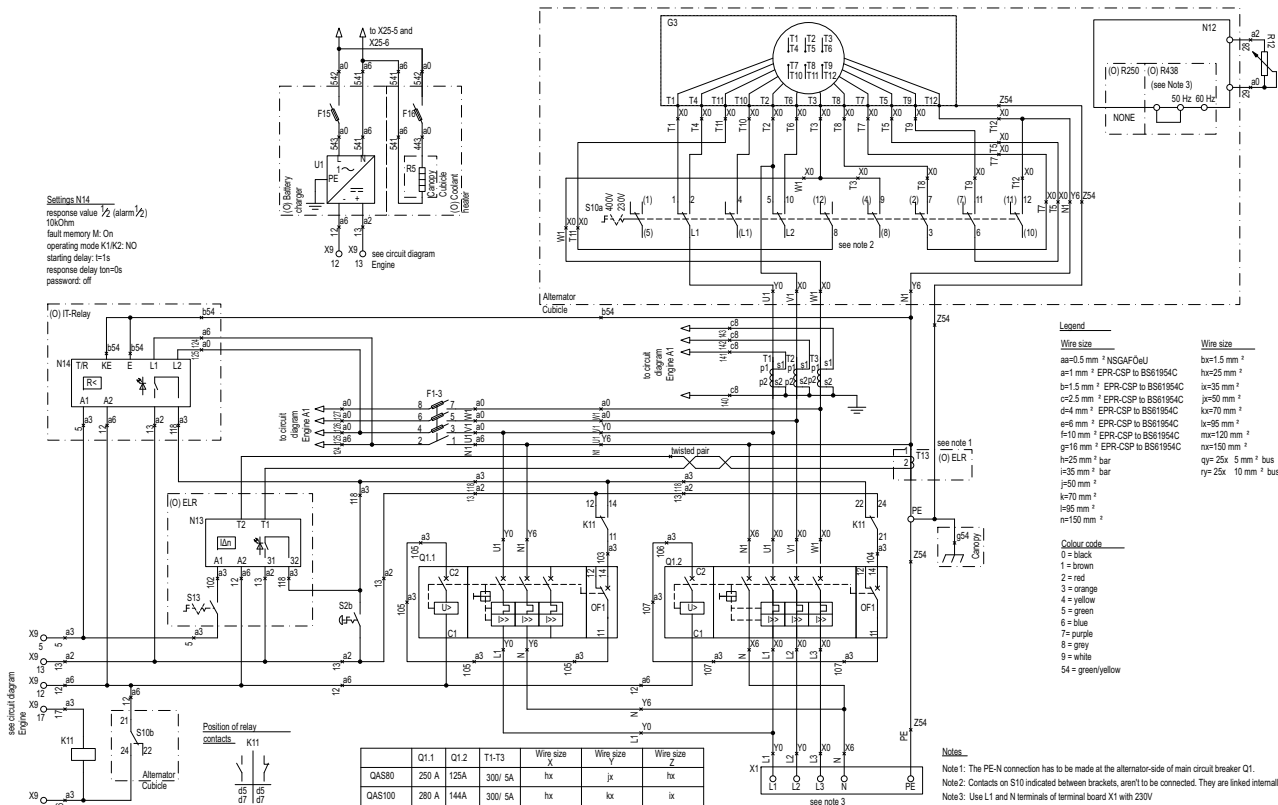

	Q1.1	Q1.2	T1-T3	Wire size X	Wire size Y	Wire size Z
QAS80	250 A	125A	300/ 5A	hx	jk	hx
QAS100	280 A	144A	300/ 5A	hx	kx	ix

Legend

Wire size

- aa=3.0 mm² NS/CAC DeU
- aa=1 mm² EPR-CSP to BS61954C
- b=1.5 mm² EPR-CSP to BS61954C
- c=2.5 mm² EPR-CSP to BS61954C
- d=4 mm² EPR-CSP to BS61954C
- e=6 mm² EPR-CSP to BS61954C
- f=10 mm² EPR-CSP to BS61954C
- g=16 mm² EPR-CSP to BS61954C
- h=25 mm² bar
- i=35 mm² bar
- j=50 mm² bar
- k=70 mm²
- l=95 mm²
- m=120 mm²
- n=150 mm²
- o=250 mm² bar
- p=25x 5 mm² bus
- q=25x 10 mm² bus

Colour code

- 0 = black
- 1 = brown
- 2 = red
- 3 = orange
- 4 = yellow
- 5 = green
- 6 = blue
- 7 = purple
- 8 = grey
- 9 = white
- 54 = green/yellow

Notes

- Note 1: The PE-N connection has to be made at the alternator-side of main circuit breaker Q1.
- Note 2: Contacts on S10 indicated between brackets, aren't to be connected. They are linked internally.
- Note 3: Use L1 and N terminals of terminal board X1 with 230V

F1-F3	Fuses 2A
F15	Fuse 6A (O)
F16	Fuse 6A (O)
G3	Alternator
K11	Auxiliary relay (voltage selection)
N12	Automatic voltage regulator
N13	Earth leakage relay (O)
N14	Insulation monitoring relay (O)
Q1.1	Circuit breaker 230 Vzz (LV)
Q1.2	Circuit breaker 400 Vd (HV)
R5	Coolant heater
R12	Voltage adjustment potmeter
S2b	Emergency stop (S2a: see Engine circuit)
S10	Voltage selector switch
S13	Earth relay lock-out switch (O)
T1-T3	Current transformer
T13	Torus earth relay (O)
U1	Battery charger (O)
X1	Terminal board
X9	Terminal strip (see Engine circuit)
(O)	Optional equipment

1636 0040 36/00

Applicable for QAS 80-100 Pd - Power Circuit, Norwegian variant

	Q1.1	Q1.2	T1-T3	Wire size X	Wire size Y	Wire size Z
QAS80	200 A	125A	300/5A	hx	lx	hx
QAS100	250 A	144A	300/5A	hx	lx	hx

Settings N13

response value overcurrent I1 (alarm): 50% of I2
 response value overcurrent I2 (alarm): 60mA
 hysteresis: 15%
 fault memory M: on
 operating mode K1/K2: NO
 starting delay: 1=1s
 response delay: ton1=0s, ton2=0s
 delay of release: toff=1s
 password: 0; off

Settings N14

response value $\frac{1}{2}$ (alarm) $\frac{1}{2}$
 10kOhm
 fault memory M: On
 operating mode K1/K2: NO
 starting delay: 1=1s
 response delay ton=0s
 password: off

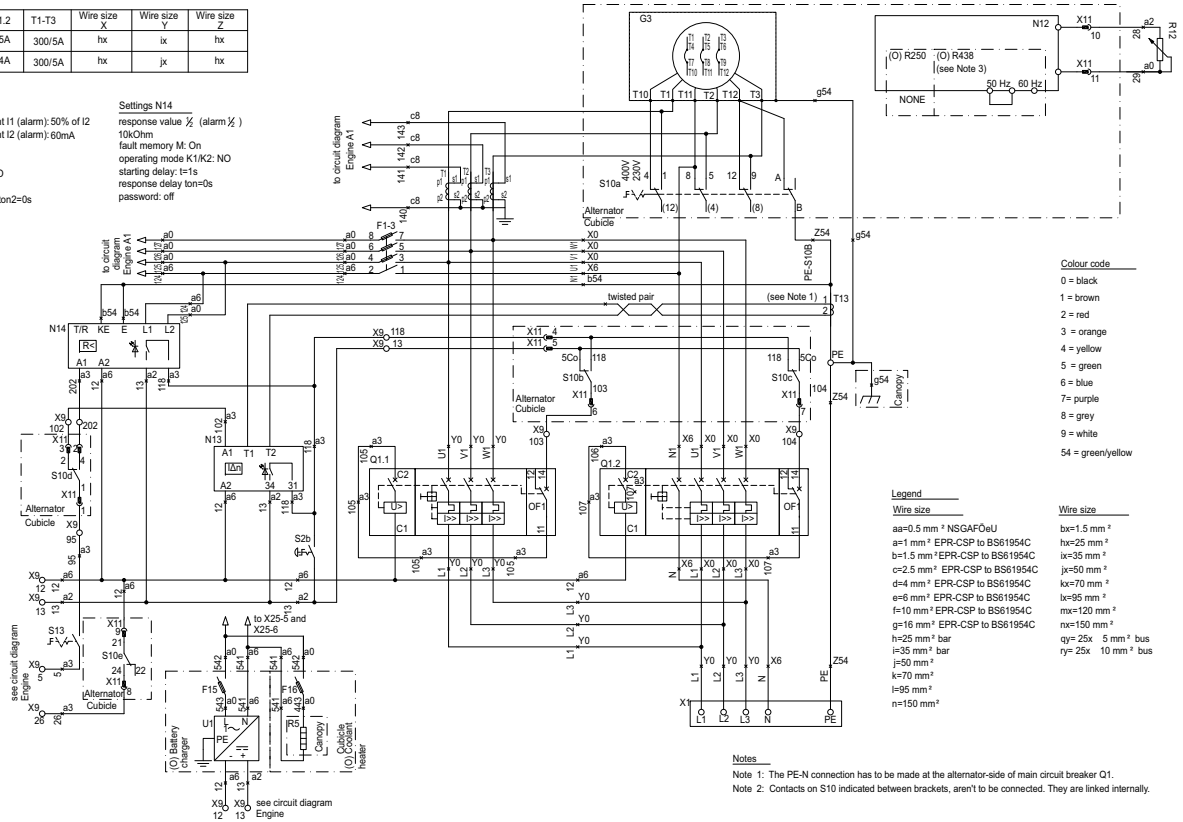

- Colour code**
- 0 = black
 - 1 = brown
 - 2 = red
 - 3 = orange
 - 4 = yellow
 - 5 = green
 - 6 = blue
 - 7 = purple
 - 8 = grey
 - 9 = white
 - 54 = green/yellow

- Legend**
- Wire size**
- aa=0.5 mm² NSGAFOeU
 - a=1 mm² EPR-CSP to BS61954C
 - b=1.5 mm² EPR-CSP to BS61954C
 - c=2.5 mm² EPR-CSP to BS61954C
 - d=4 mm² EPR-CSP to BS61954C
 - e=6 mm² EPR-CSP to BS61954C
 - f=10 mm² EPR-CSP to BS61954C
 - g=16 mm² EPR-CSP to BS61954C
 - h=25 mm² bar
 - i=35 mm² bar
 - j=50 mm²
 - k=70 mm²
 - l=95 mm²
 - n=150 mm²
- Wire size**
- bx=1.5 mm²
 - hx=25 mm²
 - lx=35 mm²
 - kx=70 mm²
 - lx=95 mm²
 - mx=120 mm²
 - nx=150 mm²
 - qx=25x 5 mm² bus
 - ry=25x 10 mm² bus

Notes

Note 1: The PE-N connection has to be made at the alternator-side of main circuit breaker Q1.
 Note 2: Contacts on S10 indicated between brackets, aren't to be connected. They are linked internally.



F1-F3	Fuses 2A
F15	Fuse 6A (O)
F16	Fuse 6A (O)
G3	Alternator
N12	Automatic voltage regulator
N13	Earth leakage relay
N14	Insulation monitoring relay
Q1.1	Circuit breaker 230 Vd (LV)
Q1.2	Circuit breaker 400 Vd (HV)
R5	Coolant heater
R12	Voltage adjustment potmeter
S2b	Emergency stop (S2a: see Engine circuit)
S10	Selector switch 50/60 Hz (O)
S13	Earth relay lock-out switch (O)
T1-T3	Current transformer
T13	Torus earth relay (O)
U1	Battery charger (O)
X1	Terminal board
X9	Terminal strip (see Engine circuit)
X11	Connector 11 pole
(O)	Optional equipment

1636 0040 41/00

Applicable for QAS 80-100 Pd - Power Circuit, multiple voltage

Settings N14

response value $\frac{1}{2}$ (alarm $\frac{1}{2}$)
 11kOhm
 fault memory M. On operating mode K1/K2: NO
 starting delay: 1=1s
 response delay ton=0s
 password: off

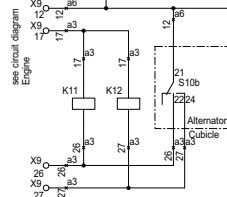
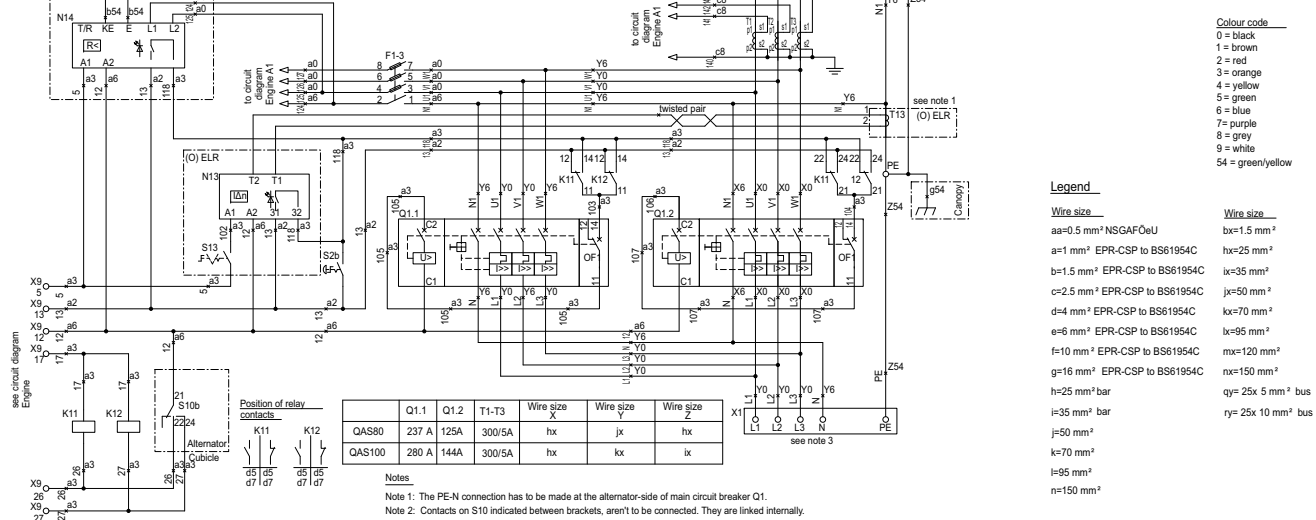
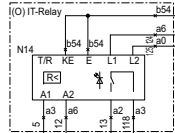
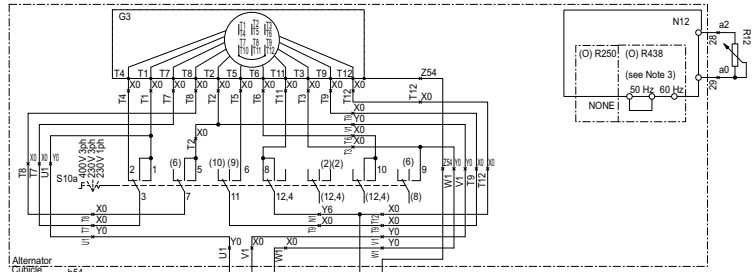
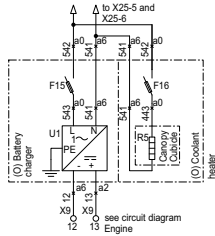

	Q1.1	Q1.2	T1-T3	Wire size X	Wire size Y	Wire size Z
QAS80	237 A	125A	300/5A	hx	jx	lx
QAS100	280 A	144A	300/5A	hx	kx	ix

Notes
 Note 1: The PE-N connection has to be made at the alternator-side of main circuit breaker Q1.
 Note 2: Contacts on S10 indicated between brackets, aren't to be connected. They are linked internally.

- Colour code
 0 = black
 1 = brown
 2 = red
 3 = orange
 4 = yellow
 5 = green
 6 = blue
 7 = purple
 8 = grey
 9 = white
 54 = green/yellow

- Legend
Wire size
 aa=0.5 mm² NSGAFOeU
 a=1 mm² EPR-CSP to BS61954C
 b=1.5 mm² EPR-CSP to BS61954C
 c=2.5 mm² EPR-CSP to BS61954C
 d=4 mm² EPR-CSP to BS61954C
 e=6 mm² EPR-CSP to BS61954C
 f=10 mm² EPR-CSP to BS61954C
 g=16 mm² EPR-CSP to BS61954C
 h=25 mm² bar
 i=35 mm² bar
 j=50 mm²
 k=70 mm²
 l=95 mm²
 n=150 mm²
Wire size
 bx=1.5 mm²
 hx=25 mm²
 ix=35 mm²
 jx=50 mm²
 kx=70 mm²
 lx=95 mm²
 mx=120 mm²
 nx=150 mm²
 qx= 25x 5 mm² bus
 rx= 25x 10 mm² bus

F1-F3	Fuses 2A
F15	Fuse 6A (O)
F16	Fuse 6A (O)
G3	Alternator
K11	Auxiliary relay (voltage selection)
K12	Auxiliary relay (voltage selection)
N12	Automatic voltage regulator
N13	Earth leakage relay (O)
N14	Insulation monitoring relay (O)
Q1.1	Circuit breaker 230 Vzz (LV)
Q1.2	Circuit breaker 400 Vd (HV)
R5	Coolant heater
R12	Voltage adjustment potmeter
S2b	Emergency stop (S2a: see Engine circuit)
S10	Voltage selector switch
S13	Earth relay lock-out switch (O)
T1-T3	Current transformer
T13	Torus earth relay (O)
U1	Battery charger (O)
X1	Terminal board
X9	Terminal strip (see Engine circuit)
(O)	Optional equipment

1636 0040 25/00

Applicable for QAS 80-100 Pd - Power Circuit Qc4002™ MkII

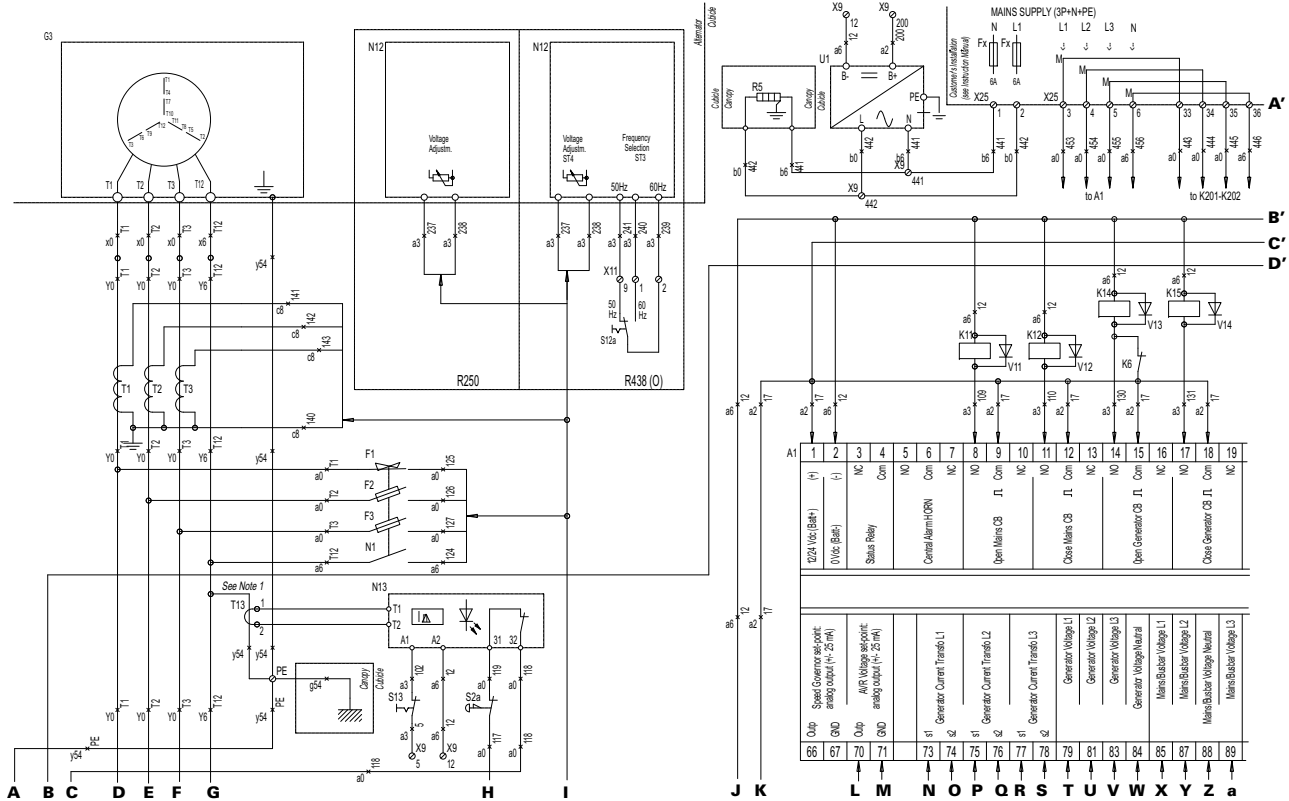

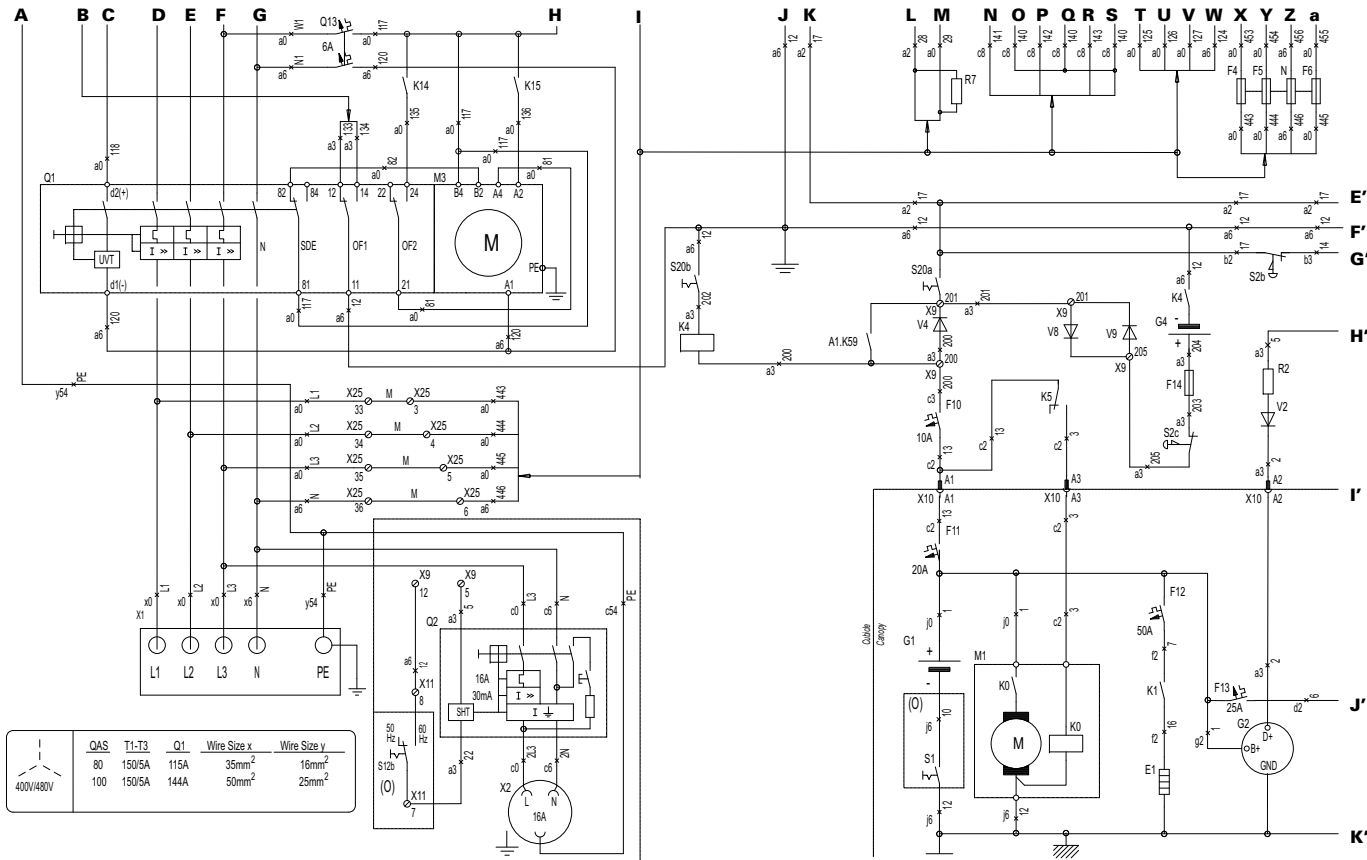

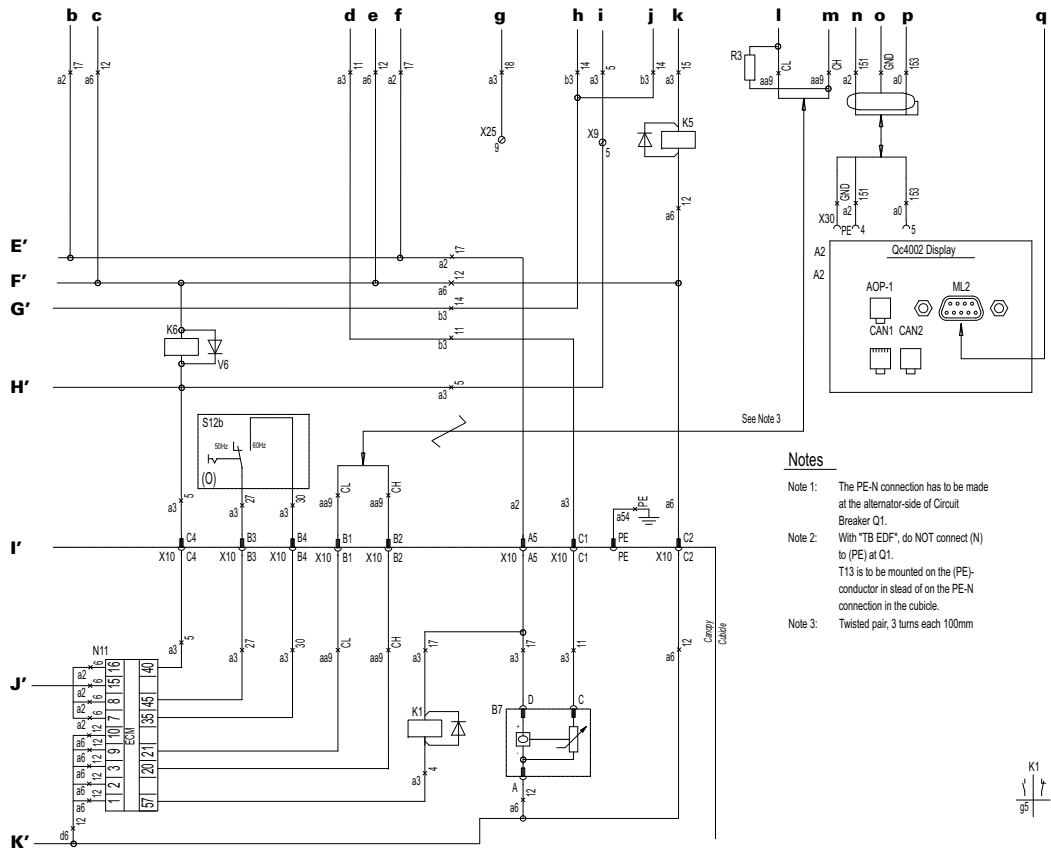

Legend

Wire size :	Colour code :
aa = 0.5mm ²	0 = black
a = 1 mm ²	1 = brown
b = 1.5mm ²	2 = red
c = 2.5mm ²	3 = orange
d = 4 mm ²	4 = yellow
e = 6 mm ²	5 = green
f = 10 mm ²	6 = blue
g = 16 mm ²	7 = purple
h = 25 mm ²	8 = grey
i = 35 mm ²	9 = white
j = 50 mm ²	54 = green/yellow
k = 70 mm ²	
l = 95 mm ²	
lx = 95 mm ² EPR-CSP (BS6195-4C)	
bx = 1.5mm NSGAF0eU	

Notes

- Note 1: The PE-N connection has to be made at the alternator-side of Circuit Breaker Q1.
- Note 2: With "TB EDF" do NOT connect (N) to (PE) at Q1. T13 is to be mounted on the (PE)-conductor in stead of on the PE-N connection in the cubicle.
- Note 3: Twisted pair, 3 turns each 100mm

Position of Relay Contacts

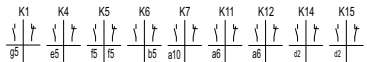

A1	Generator control unit	K15	Aux. relay open GCB	V7	Free-wheeling diode Y7 (O)
A2	LCD display	M1	Starter motor	V8	Charging current limiting diode
A3	PMS CAN-communication	M3	Motor drive for Q1	V9	Feed forward diode
B7	Fuel level sensor	N11	ECM	V11,V12	Free-wheeling diode K11,K12
E1	Preheat resistor	N12	Automatic voltage regulator	X1	Terminal board
F1-6	Fuse 250mA	N13	Earth leakage relay	X2	1phase socket (16 A)
F10	Circuit breaker 10A	Q1	Circuit breaker	X9	Terminal strip
F11	Fuse 20A DC	Q2	Circuit breaker 16 A	X10	Connector wire harness
F12	Fuse 50A DC	Q13	Circuit breaker 6 A	X25	Customer's terminal strip
F13	Fuse 25A DC	R2	Excitation resistor 47 ohm	X30	PMS/ALS interface connector
F14	Fuse 5A DC	R3	Resistor 120 ohm engine CAN-bus	Y7	Air inlet shutdown valve (O)
G1	Battery 12Vdc	R5	Coolant heater (O)	(O)	Optional equipment
G2	Charging alternator	R7	Resistor 47 Ohm Volt. adj.		
G3	Alternator	S1	Battery switch (O)		
G4	Aux. battery	S2a,b,c	Emergency stop		
K0	Starter solenoid	S12	Dual frequency switch (O)		
K1	Prehaet relay	S13	Earth leak. disable switch		
K4	Decoupling relay for G4	S20a,b	ON/OFF switch		
K5	Starter relay	T1-T3	Current transformers		
K6	Fuel solenoid relay	T13	Torus earth leakage		
K7	Aux. relay for Y7 (O)	U1	Battery charger		
K11	Aux. relay open MCB	V2	Excitation diode		
K12	Aux. relay close MCB	V4	Polarisation diode		
K14	Aux. relay close GCB	V6	Free-wheeling diode K6		

Following documents are provided with this unit:

- Test Certificate
- EC Declaration of Conformity:

EC DECLARATION OF CONFORMITY

1 We, Grupos Electrógenos Europa S.A., declare under our sole responsibility, that the product

2 Machine name : **Power Generator**

3 Commercial name :

4 Serial number :

5 Which falls under the provisions of the article 12.2 of the EC Directive 2006/42/EC on the approximation of the laws of the Member States relating to machinery, is in conformity with the relevant Essential Health and Safety Requirements of this directive.

The machinery complies also with the requirements of the following directives and their amendments as indicated.

Directive on the approximation of laws of the Member States relating to	Harmonized and/or Technical Standards used	Att'mnt.
Machinery safety	2006/42/EC EN ISO 12100-1 EN ISO 12100-2 UNE EN 12501	
Electromagnetic compatibility	2004/108/EC EN 61000-6-2 EN 61000-6-4	
Low voltage equipment	2006/95/EC EN 60334 EN 60204-1 EN 60439	
Outdoor noise emission	2000/14/EC ISO 3744	

6 The harmonized and the technical standards used are identified in the attachments hereafter

7 Grupos Electrógenos Europa, S.A. is authorized to compile the technical file

Conformity of the specification to the Directives	Conformity of the product to the specification and by implication to the directives
8 Issued by	9 Product Engineering
10 Name	11 Manufacturing
12 Signature	

13 Place, Date *Muel (Zaragoza), Spain*

Grupos Electrógenos Europa, S.A. A company within the Atlas Copco Group

Postal address: Phone: +34 902 110 318
 Polígono Pizarro II, Parcela 20 V.A.T A65224880
 50450 Muel ZARAGOZA Fax: +34 902 110 318
 Spain For info, please contact your local Atlas Copco representative
 www.atlas-copco.com

Form 160 0000387
ed. 01/2014 12/09 p. 1/10

- Outdoor Noise Emission
Directive 2000/14/EC:

Outdoor Noise Emission Directive 2000/14/EC

1. Conformity assessment procedure followed : Full Quality Assurance

2. Name and address of the notified body : Notified body number 0499
SNCH, Societat Nacional de Certificacion
et d'Homologation
L-5201 Sandweiler

3. Measured sound power level : dB(A)

4. Guaranteed sound power level : dB(A)

5. Electric power : kW

Grupos Electrificados Europa, S.A. A company within the Atlas Copco Group

Postal address Phone: +34 902 110 316 V.A.T. A05324680
Poligono Pitarco II, Parcela 20 Fax: +34 902 110 318
50450 Muel ZARAGOZA
Spain
www.atlas-copco.com For info, please contact your local Atlas Copco representative

Form 1000/0002
Rev. 15/01/02/02

p.2/10

