

















# HR17 4x4



- (A) 17.2m  
56ft 6in 
- (B) 15.2m  
50ft 
- (C) 9.4m  
31ft 
- 225kg  
500lbs 
- 1.8m x 0.85m  
5ft 11in x 2ft 9in 
- 150° 
- 180° 
- (D) 2.1m  
6ft 11in 
- (F) 2m  
6ft 7in 
- (H) 4.8m  
15ft 9in 
- (J) 6.35m  
20ft 10in 
- 6km/h  
3.7mph 
- 3.7m  
12ft 2in 
- 45°  
24° 
- 5000kg  
11020lbs 
-  

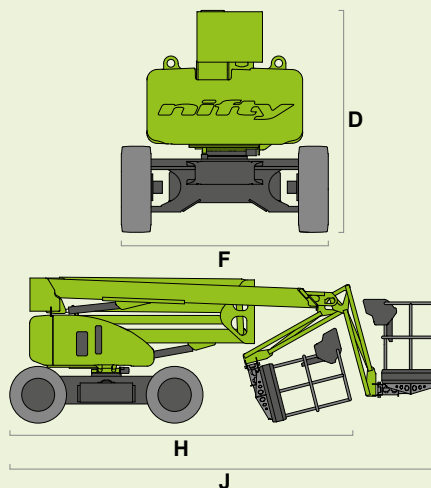
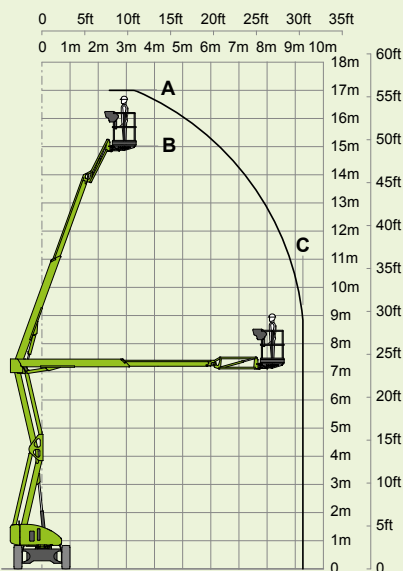

**SiOPS®** **Niftylift®**  
**toughcage** **Gen² Hybrid**

[niftylift.com.au](http://niftylift.com.au)

11 Kennington Drive Tomago NSW 2322

02 4964 9765 or 1300 4 NIFTY

sales@niftylift.com.au



 Hybrid²

