



Atlas Copco



Complete submersible pumping solutions

The WEDA range (60 Hz) US market

WEDA submersible pumps

WEDA electric submersible pumps and accessories are designed for an extensive range of dewatering applications, across multiple industries. They provide the performance, reliability and ease of use you need. WEDA pumps feature a built-in starter and motor protection system or a terminal board connection to connect to an external control box along with optional automatic level control. Adjustable wear-resistant rubber diffusers and hardened high-chrome impellers ensure durability in tough environments.

At Atlas Copco, we understand pumps, their applications and, most importantly, the people using them. We have a complete range of high-quality and lightweight electric submersible pumps designed specifically for drainage, sludge and slurry pumping applications and available in global voltages.

WEDA pumps are made for durability. The unique sealing system and modular design make them among the most flexible pumps on the market. Easy to use and maintain, WEDA pumps promise optimal performance. The WEDA seal system is designed to provide the optimum maintenance solution and can be easily fitted at the job site.

WATER
DENSITY →  →
UP TO **87.40** lb/ft³

SOLIDS
HANDLING
UP TO **2** inch 

UP TO
40% 
LIGHTER
IN WEIGHT













HIGH WEAR
RESISTANCE 



There is a WEDA pump for any dewatering application

We understand the dewatering needs of our customers, which vary with location and application. Accordingly our submersible range is developed for drainage (D), sludge (S) and slurry (L) applications.

These applications call for pumps designed specifically for handling corrosive and abrasive media and their solid contents.

Drainage pumps (WEDA D)	Sludge pumps (WEDA S)	Slurry pumps (WEDA L)
		
 <p>WATER DENSITY UP TO 68 lb/ft³</p>	 <p>WATER DENSITY UP TO 87 lb/ft³</p>	 <p>WATER DENSITY UP TO 106 lb/ft³</p>
 <p>DESIGN TOP DISCHARGE</p>	 <p>DESIGN BOTTOM SIDE DISCHARGE</p>	 <p>DESIGN BOTTOM SIDE AND TOP DISCHARGE</p>
<p>SOLIDS HANDLING UP TO 0.5 inch</p>	<p>SOLIDS HANDLING UP TO 2 inch</p>	<p>SOLIDS HANDLING UP TO 2.5 inch</p>
 <p>pH VALUES FROM 5 TO 8</p>	 <p>pH VALUES FROM 5 TO 8</p>	 <p>pH VALUES FROM 2 TO 10</p>
<ul style="list-style-type: none"> • General dewatering • Ground water • Raw water • Construction sites 	<ul style="list-style-type: none"> • Water containing mud • Sludge or light slurry • Tank clean-out • Trench and pond cleaning • Mining 	<ul style="list-style-type: none"> • Abrasive media with high solids content • Quarries • Dredging • Settling ponds

Drainage pumps WEDA D

The WEDA drainage pumps handle either clean or dirty water, even with small solids with the best performance and efficiency.

WEDA+ *

1. Rotation control
2. Phase failure protection
3. Thermal switches

* or with terminal board motor connection.

FLEXIBILITY

Discharges can be mounted vertically or sideways as required

MOTOR PROTECTION

Class F motors, with thermal switches in each winding

EXTENDED PERFORMANCE

Pump design ensures all-round motor cooling for better performance

IMPROVED CABLE SEALING

Ensures protection against water leakage from cable entry

HIGH CORROSION RESISTANCE

Unique aluminum alloy offers the perfect combination of strength, light weight and corrosion resistance

MODULAR SEALING SOLUTION

Based on pump size, the sealing system is adapted to provide the best solution

IMPROVED WEAR RESISTANCE

High-chrome (560HB or 55HRC) impellers provide higher wear resistance

560 
HB

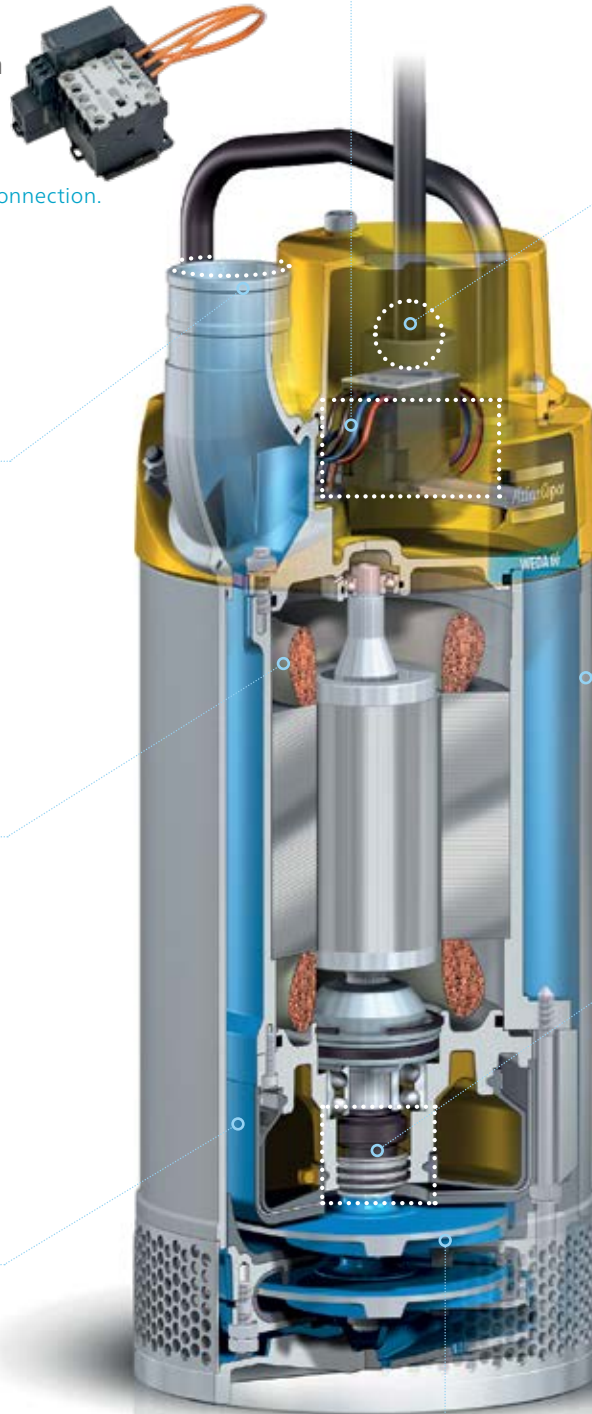

Sludge pumps WEDA S

The WEDA sludge pumps can handle thick, soft, wet mud or other similarly viscous mixtures of liquids and solids, especially the product of an industrial or refining process.

IMPROVED CABLE SEALING

Ensures protection against water leakage from cable entry

DRY RUNNING CAPABILITIES

Improved rib design offers external cooling to motor for extended running time

MOTOR PROTECTION

Class F motors, with thermal switches in each winding

HIGHER SOLIDS HANDLING

Sludge pumps can handle solids up to 2 inch

**SOLIDS
HANDLING**
UP TO **2** inch

ROBUST DESIGN

Base of the pump ensures stability while enabling passage of large solids

WEDA+ *

1. Rotation control
2. Phase failure protection
3. Thermal switches

* or with terminal board motor connection.



EASY INSPECTION

External oil inspection plug for quick inspection of oil

MODULAR SEALING SOLUTION

Based on pump size, the sealing system is adapted to provide the best solution

SUSTAINABLE PERFORMANCE

High-chrome (560HB or 55HRC) impellers provide higher wear resistance

560 
HB

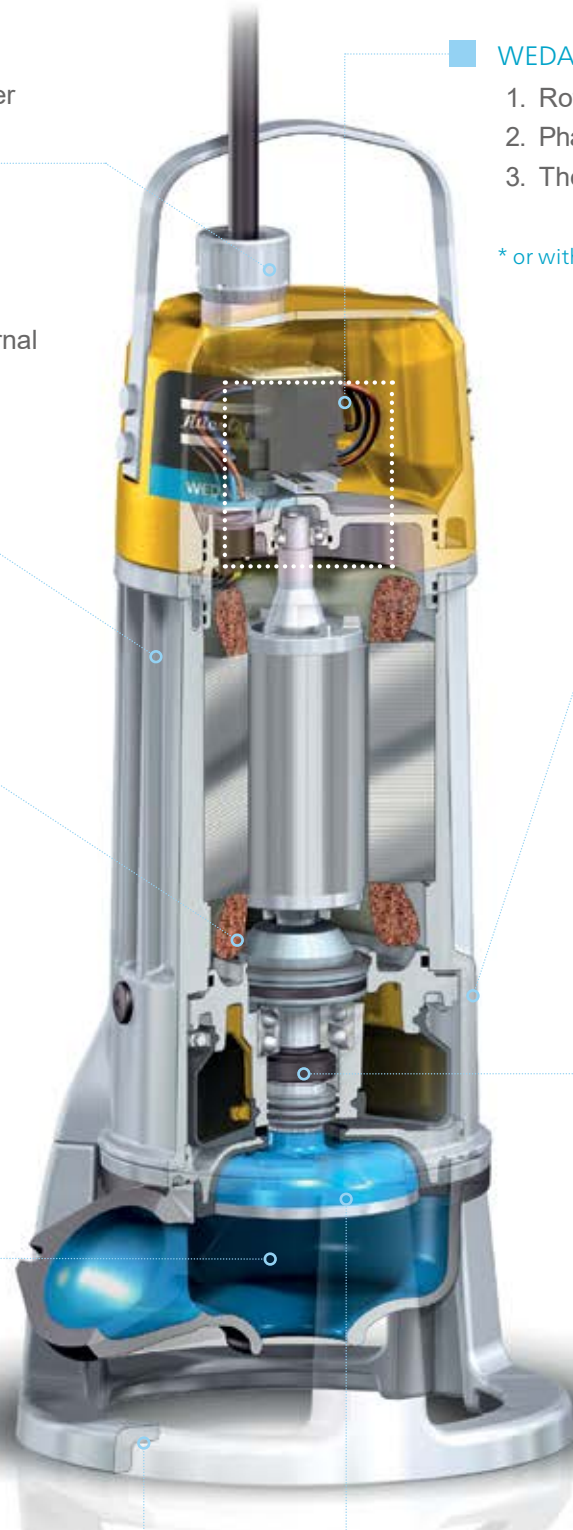

Slurry pumps WEDA L

The WEDA slurry pumps are the toughest, and have the largest apertures to facilitate handling of slurry with the most challenging solids.

EFFICIENT MOTOR

Electric motor insulation class H with PTC and Clicson thermal protection and service factor S1

ROBUST DESIGN

Heavy duty bearings to withstand shocks and overloads

REINFORCED SEALING

A double silicon carbide mechanical seal for duty application

SUSTAINABLE PERFORMANCE

High efficiency high chrome agitator to lift settled solids

EASY ACCESS

Efficient motor cooling with top discharge and side flow

HIGH ABRASION RESISTANCE

Thanks to the high-chrome wear parts

HIGHER SOLIDS HANDLING

Slurry pumps can handle solids up to 2.5 in

SOLIDS HANDLING
UP TO **2.5** inch



We have all the accessories you need for your WEDA pump

Control panel

For easy control of pumps, different options available.



Discharge connections

It can be mounted in either a vertical or horizontal position.



• NPT

Slim Adapter

For lowering pumps in narrow pipes and manholes D50H, D60H, D70H, D90H only



Raft

For easy floatation of pump with fluctuating water levels. Strainer option available



Level regulators

For easy control of water level by automatic pump switch-on/-off:



• Float switch

Zinc anodes

Specifically required for pumping water with a high concentration of salts such as sea water, brine, etc.



Hoses and Couplings

All connections and hoses available to complete the pump installation.



Service kits

Seal kit

The seal kit is the proper selection of high quality components for a mechanical seal change to ensure trouble-free operation after servicing.

- O-ring kit
- Mechanical shaft seal



Instant service pack

The instant service pack is a preassembled, tested and ready-to-use seal system containing the mechanical shaft seals, bearings, gaskets and oil to ensure trouble-free operation. It offers a quick onsite repair option due to ease of installation and therefore reduces the machine downtime cost.



Wear part kit

The wear part kit is a typical selection of components to bring the pump performance back to factory standard. The ideal solution for a machine overhaul or refurbishment.

- Impeller
- Wear plate
- Diffuser
- Impeller nut

WEDA D range

Technical data



		WEDA D04N	WEDA D04BN	WEDA D08N	WEDA D10N		WEDA D30L		WEDA D30N		WEDA D40N
Specifications		1ph	1ph	1ph	1ph	3ph	1ph	3ph	1ph	3ph	3ph
Max. head	ft	39	39	50	52	52	62	58	90	85	66
Max. flow	gpm	60	42	70	130	130	380	370	210	200	400
	m ³ /h	14	9.5	16	30	30	86	84	48	45	90
Shaft speed	r.p.m.	3500	3500	3500	3500	3500	3500	3500	3500	3500	3500
Rated output	HP	0.5	0.5	1	1.5	1.5	3.0	3.0	3.0	3.0	4.3
Max. power input	kW	0.65	0.65	1.2	1.6	1.2	3.1	2.8	3.1	2.8	3.8
Discharge connection	inch	2"	1"	2"	2"	2"	3"	3"	3"	3"	3"
Max. solids handling size	inch	0.3"	0.18"	0.3"	0.16"	0.16"	0.27"	0.27"	0.27"	0.27"	0.27"
Weight and dimensions											
Weight	lbs	20	21	28	28	28	45	45	45	45	56
Height	inch	13.4	16.4	14.1	18.5	18.5	20.6	20.6	20.6	20.6	20.6
Width	inch	7.2	8.7	7.3	8.8	8.8	11.4	11.4	11.4	11.4	11.4
Diameter	inch	7.2	8.7	7.3	7.3	7.3	8.7	8.7	8.7	8.7	8.7

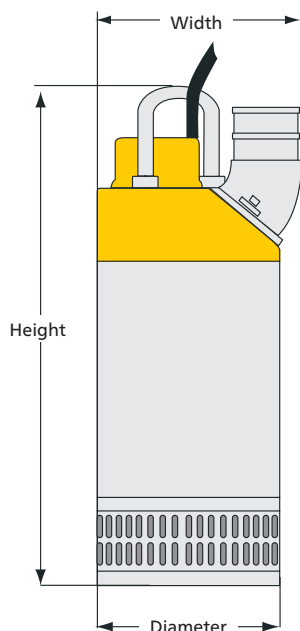

Typical applications

- General dewatering
- Ground water
- Raw water
- Construction sites



Performance curves

WEDA D04N

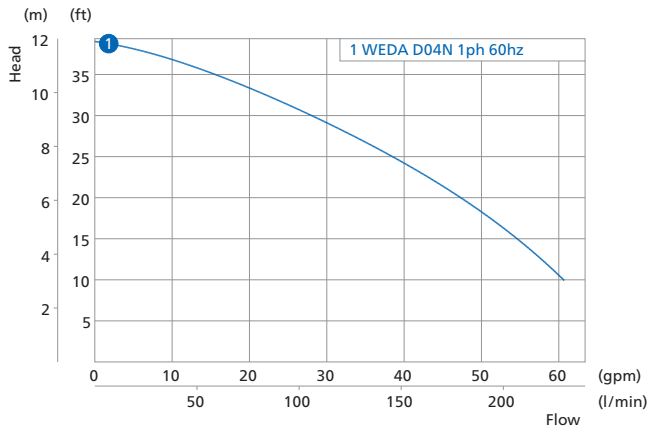

WEDA D04BN

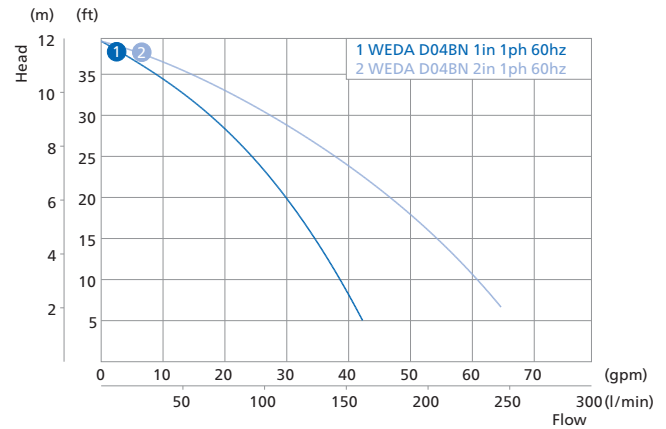

WEDA D08N

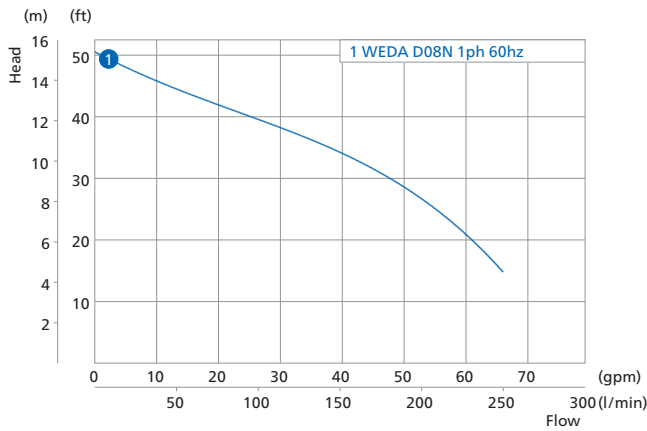

WEDA D10N

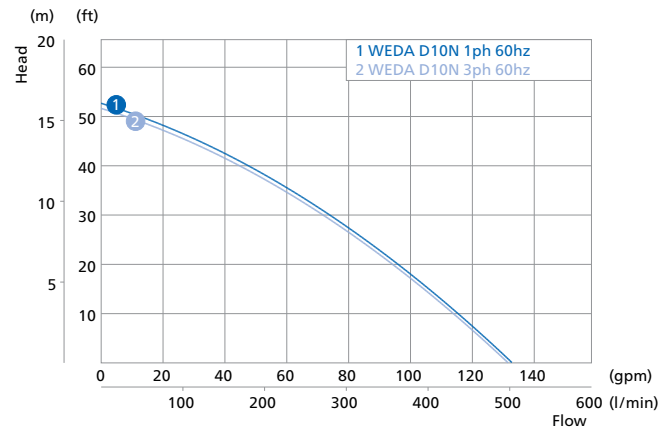

WEDA D30L, D30N

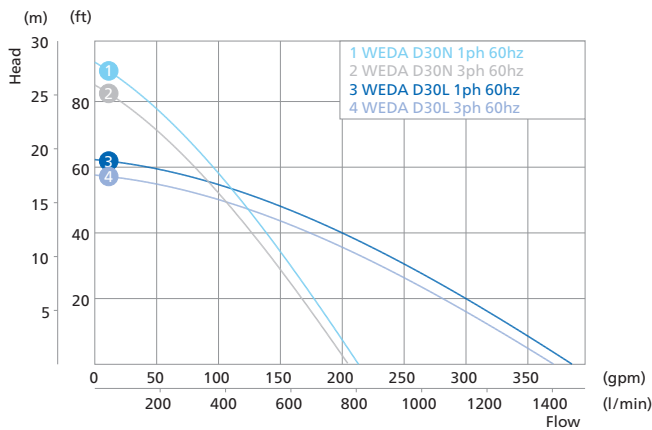

WEDA D40N

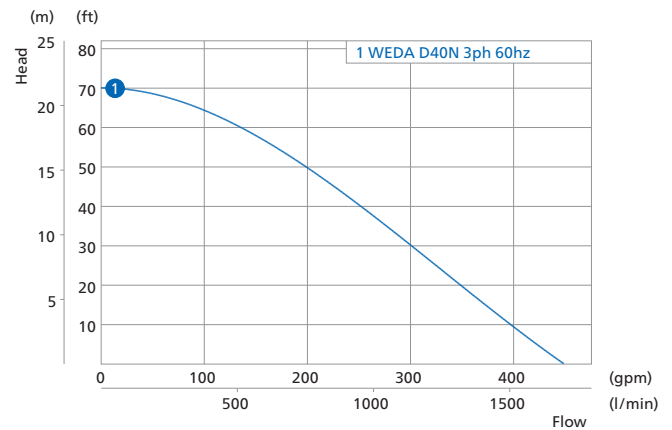

WEDA D range

Technical data



		WEDA D50N	WEDA D50H	WEDA D60N	WEDA D60H	WEDA D60SH	WEDA D70L	WEDA D70H	WEDA D80N	WEDA D80H	WEDA D90L	WEDA D90H	WEDA D100N
Specifications		3ph	3ph	3ph	3ph	3ph	3ph	3ph	3ph	3ph	3ph	3ph	3ph
Max. head	ft	83	135	100	170	250	130	205	145	240	140	325	115
Max. flow	gpm	620	310	700	340	260	1200	650	1600	750	1700	600	6000
	m ³ /h	141	70	159	77	59	273	148	363	170	386	136	1363
Shaft speed	r.p.m.	3500	3500	3500	3500	3500	3500	3500	3500	3500	3500	3500	1750
Rated output	HP	8.5	8.5	11.5	11.5	11.5	18	18	31	31	40	40	90
Max. power input	kW	8.3	8.3	9.9	9.9	9.9	17	17	26	26	33	33	80
Discharge connection	inch	4"	3"	4"	3"	3"	6"	4"	6"	4"	6"	4"	10"
Max. solids handling size	inch	0.31"	0.31"	0.31"	0.31"	0.31"	0.39"	0.39"	0.47"	0.47"	0.27"	0.27"	0.47"
Weight and dimensions													
Weight	lbs	122	122	136	136	138	244	244	390	390	400	400	1133
Height	inch	28.3	28.3	29.9	29.9	29.9	37.1	37.1	38.6	38.6	43.3	43.3	55.5
Width	inch	13	11.9	13	11.9	11.9	16.4	15.5	27.2	26.2	18.9	18.9	25.5
Diameter	inch	10.9	10.9	10.9	10.9	10.9	14.6	14.6	20.9	20.9	15.8	15.8	23.6

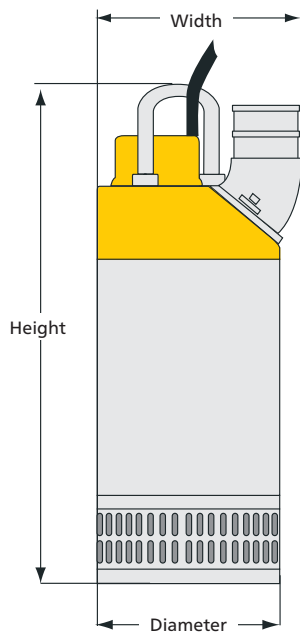

Typical applications

- General dewatering
- Ground water
- Raw water
- Construction sites



Performance curves

WEDA D50N, D50H

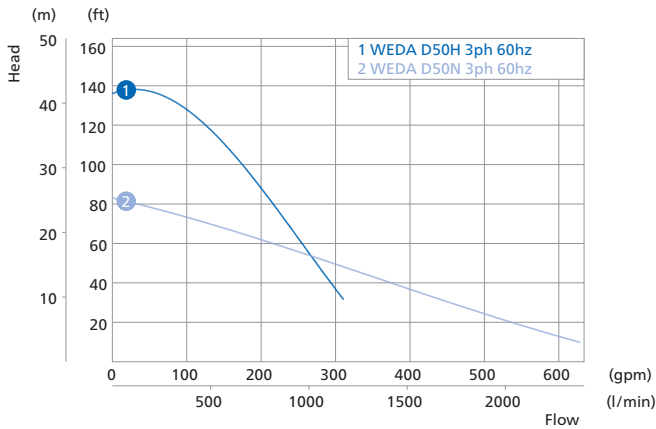

WEDA D60N, D60H, D60SH

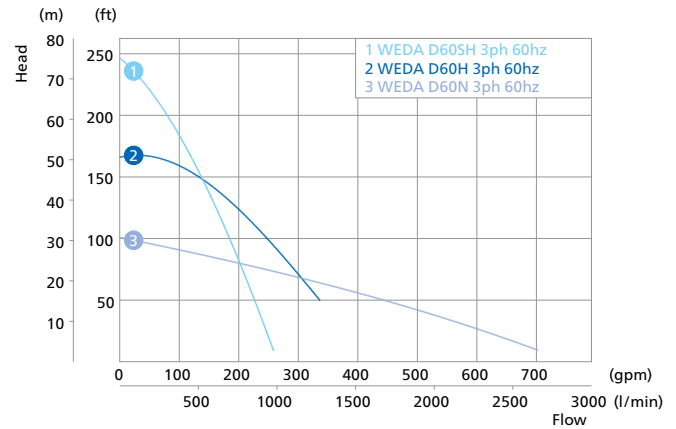

WEDA D70L, D70H

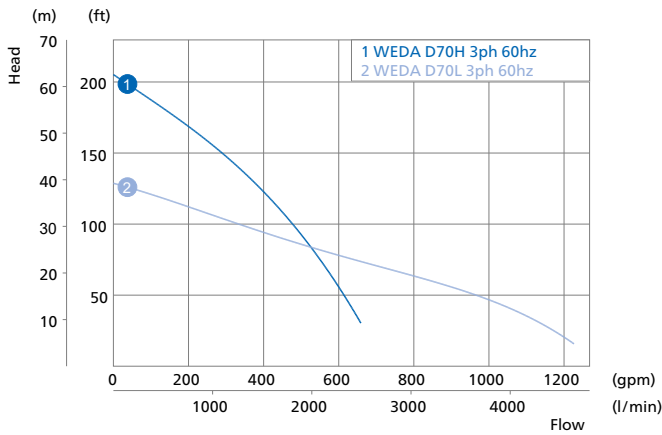

WEDA D80N, D80H

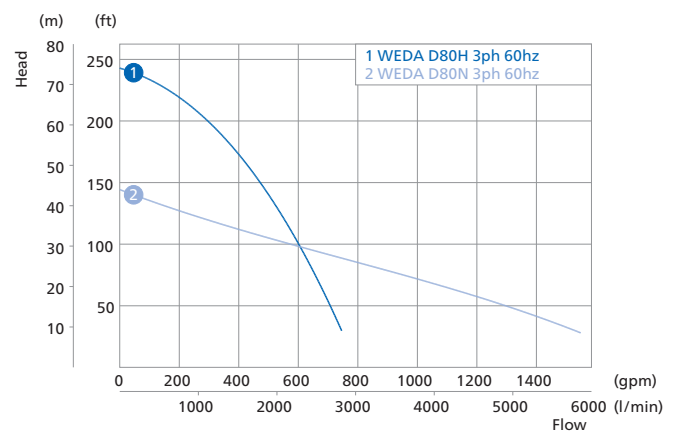

WEDA D90L, D90H

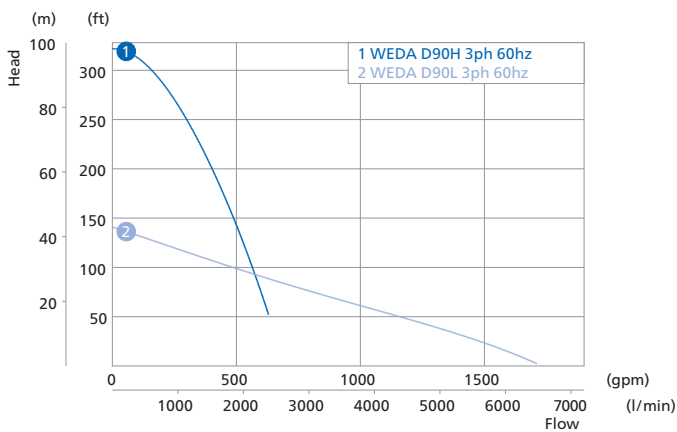

WEDA D100N

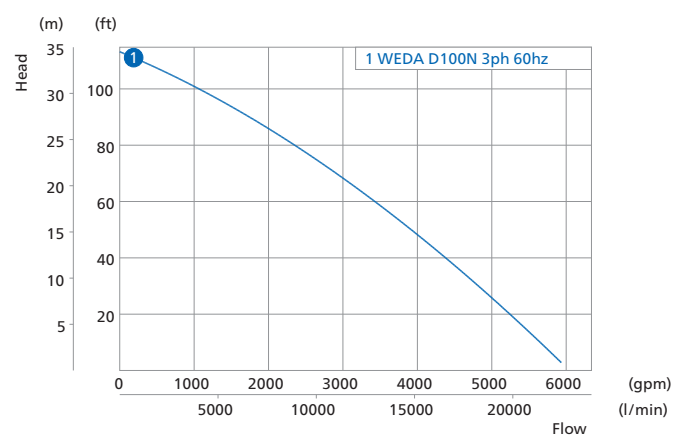

WEDA S range

Technical data



		WEDA S04N	WEDA S08N	WEDA S30N		WEDA S50N	WEDA S60N
Specifications		1ph	1ph	1ph	3ph	3ph	3ph
Max. head	ft	33	48	52	58	90	100
Max. flow	gpm	60	70	225	250	370	420
	m ³ /h	14	16	51	57	84	95
Shaft speed	r.p.m.	3500	3500	3500	3500	3500	3500
Rated output	HP	0.5	1.0	3.0	4.0	7.0	9.3
Max. power input	kW	0.65	1.2	2.9	3.3	5.6	8.2
Discharge connection	inch	2"	2"	3"	3"	4"	4"
Max. solids handling size	inch	1"	1"	2"	2"	2"	2"
Weight and dimensions							
Weight	lbs	22	29	55	55	132	144
Height	inch	14.7	16.4	24.3	24.3	31.9	34.2
Width	inch	10.9	10.9	12.8	12.8	17.7	17.7
Diameter	inch	9.5	9.5	9.8	9.8	13.8	13.8

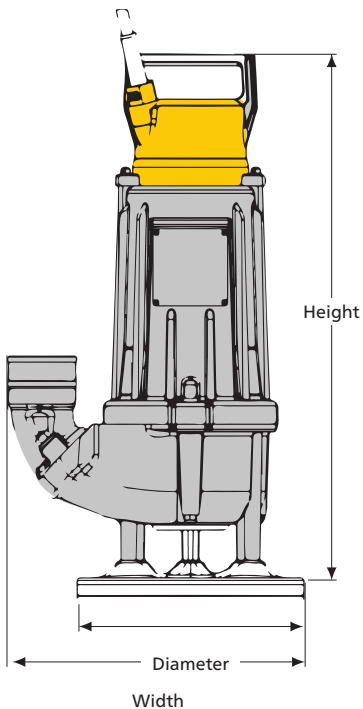

Typical applications

- Water containing mud
- Sludge or light slurry
- Tank clean-out
- Trench and pond cleaning
- Mining



Performance curves

WEDA S04N

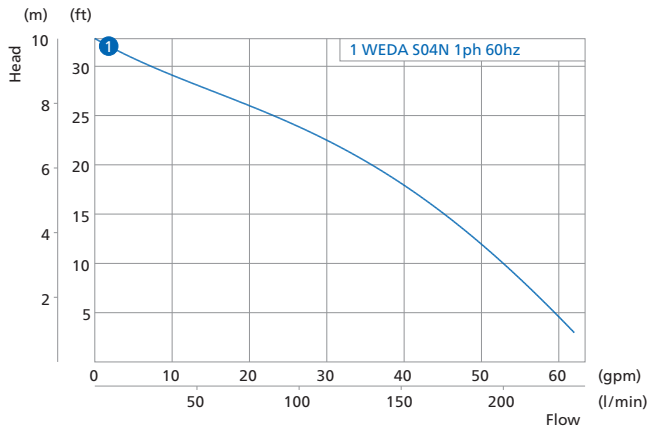

WEDA S08N

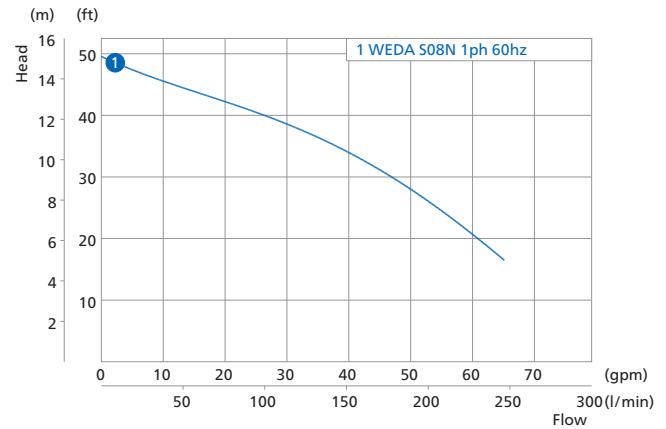

WEDA S30N

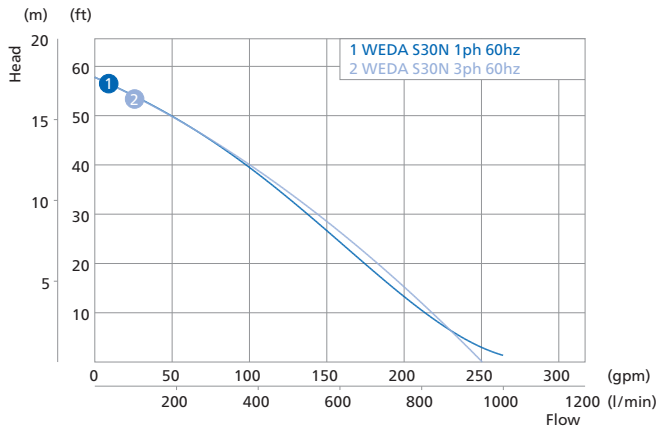

WEDA S50N

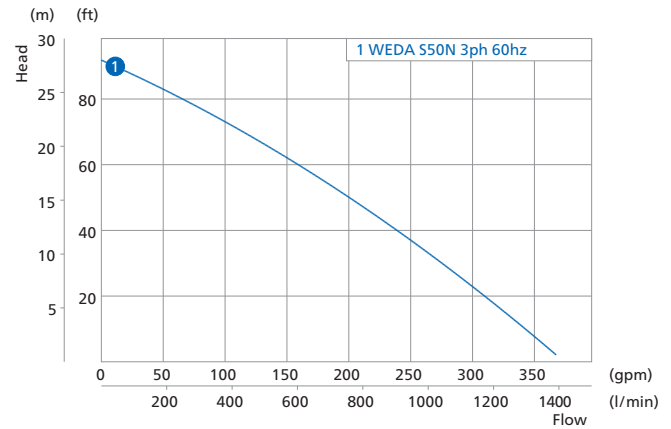

WEDA S60N

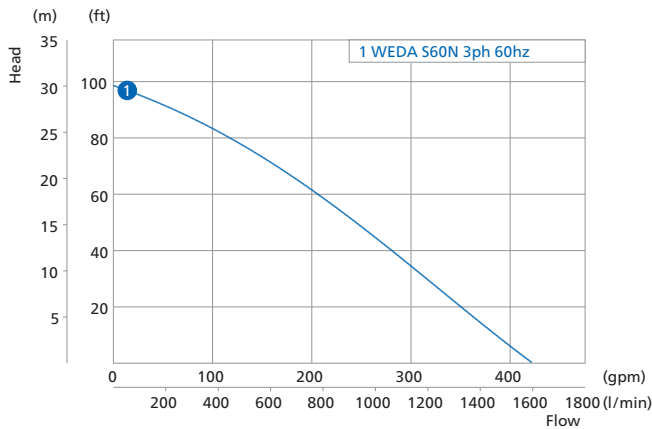

WEDA L range

Technical data



		WEDA L40N	WEDA L50N	WEDA L60N	WEDA L70N	WEDA L80N	WEDA L95N	WEDA L100N	WEDA L110N
Specifications		3ph	3ph	3ph	3ph	3ph	3ph	3ph	3ph
Max. head	ft	47	60	75	80	100	170	115	130
Max. flow	gpm	220	350	480	530	800	1200	2500	2200
	m ³ /h	50	79	109	120	182	273	568	500
Shaft speed	r.p.m.	1750	1750	1750	1750	1750	1750	1150	1750
Rated output	HP	5.0	7.4	12.0	14.8	20	50	60	100
Max. power input	kW	4.5	6.8	10.4	12.8	16.1	40	49	80
Discharge connection	inch	3"	4"	4"	4"	4"	4"	6"	6"
Max. solids handling size	inch	0.8"	1"	1"	1"	1"	1.4"	2.4"	2.4"
Weight and dimensions									
Weight	lbs	411	573	573	595	689	1667	2233	2378
Height	in	31	36	36	36	42.5	63.2	63.2	63.2
Width	in	15	17	17	17	22.8	36.8	36.8	36.8
Diameter	in	13	16	16	16	19.5	21.5	21.5	21.5

Typical applications

- Abrasive media with high solids content
- Quarries
- Dredging
- Settling ponds

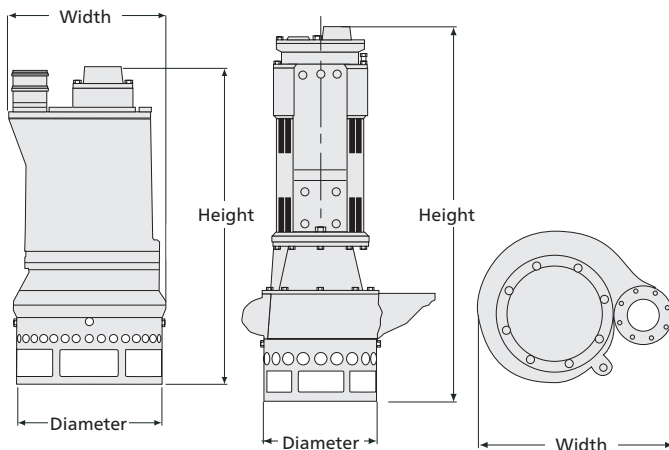

Performance curves

WEDA L40N

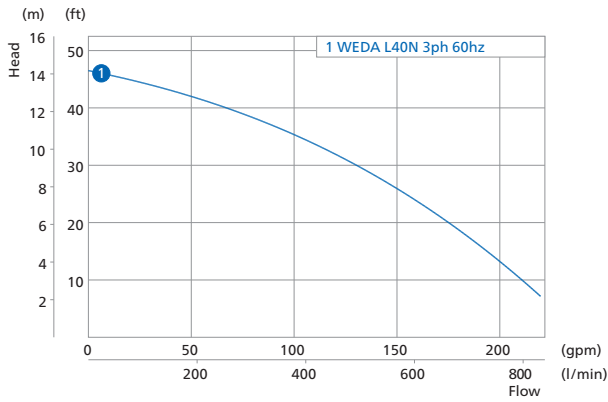

WEDA L50N

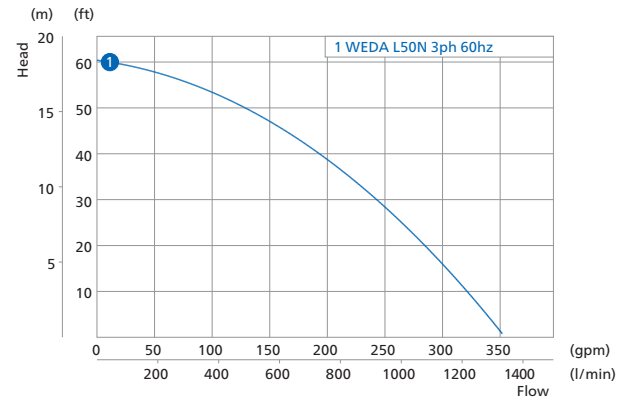

WEDA L60N

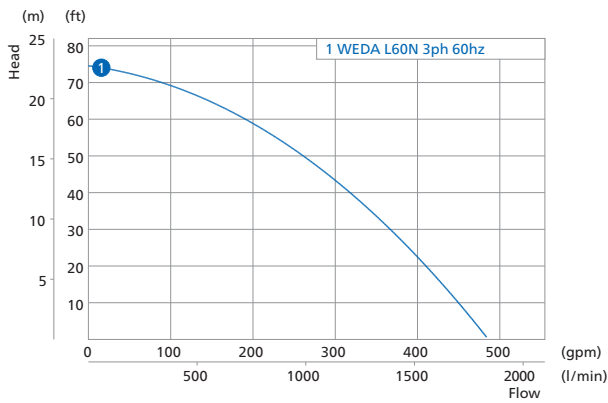

WEDA L70N

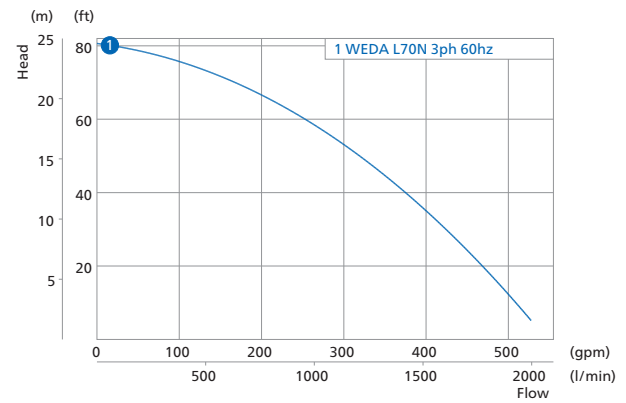

WEDA L80N

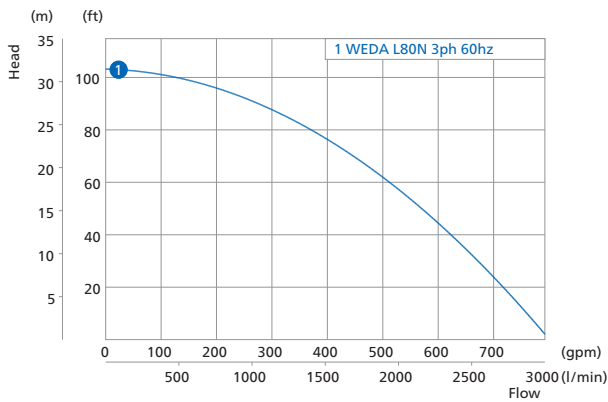

WEDA L95N

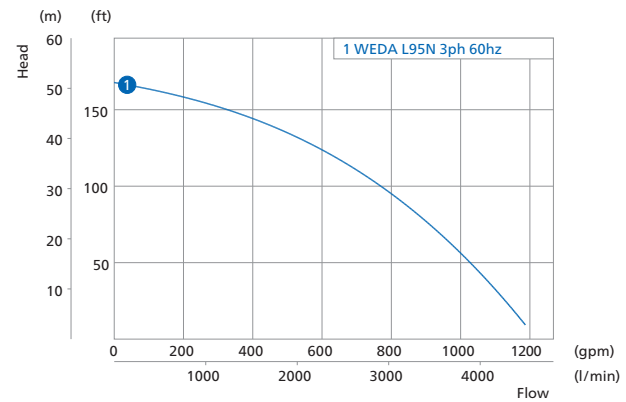

WEDA L100N

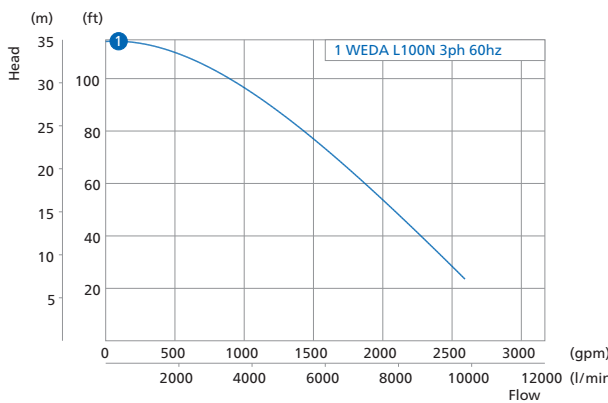

WEDA L110N

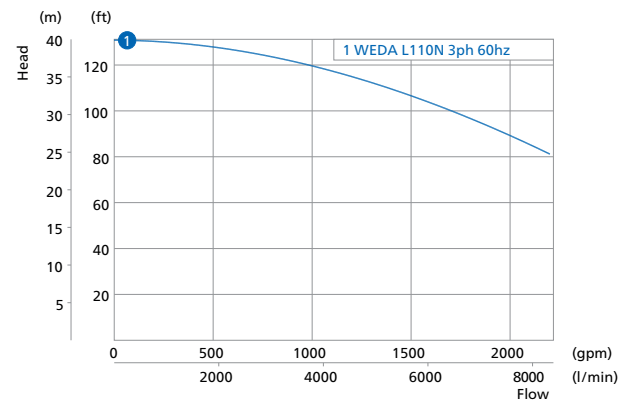

Product portfolio

GENERATORS

PORTABLE
1,6-12 kVA



MOBILE
25-1,200* kVA



*Multiple configurations available to produce power for any size application

DEWATERING PUMPS

ELECTRIC SUBMERSIBLE
up to 6,100 US gpm



SURFACE PUMPS
up to 8,500 US gpm



Diesel and electric options available

LIGHT TOWERS

METAL HALIDE



**DIESEL LED
ELECTRIC LED**



AIR COMPRESSORS AND HANDHELD TOOLS

AIR COMPRESSORS
110-1,800 cfm
58-508 psi



HANDHELD TOOLS
Pneumatic
Hydraulic
Petrol engine driven



ONLINE SOLUTIONS

SHOP ONLINE PARTS ONLINE

Find and order the spare parts for power equipment. We handle your orders 24 hours a day.



POWER CONNECT

Scan the QR code on your machine, and go to the QR Connect Portal to find all the information about your machine.



LIGHT THE POWER YOUR SIZING TOOL

A useful calculator to help you choose the best solution for your power and light needs



FLEETLINK

Intelligent telematics system that helps optimize fleet usage, reduce maintenance costs, ultimately saving time and cost.



Atlas Copco

Atlas Copco AB
atlascopco.com