

I-GUIDE

VERTI BEAM 1000

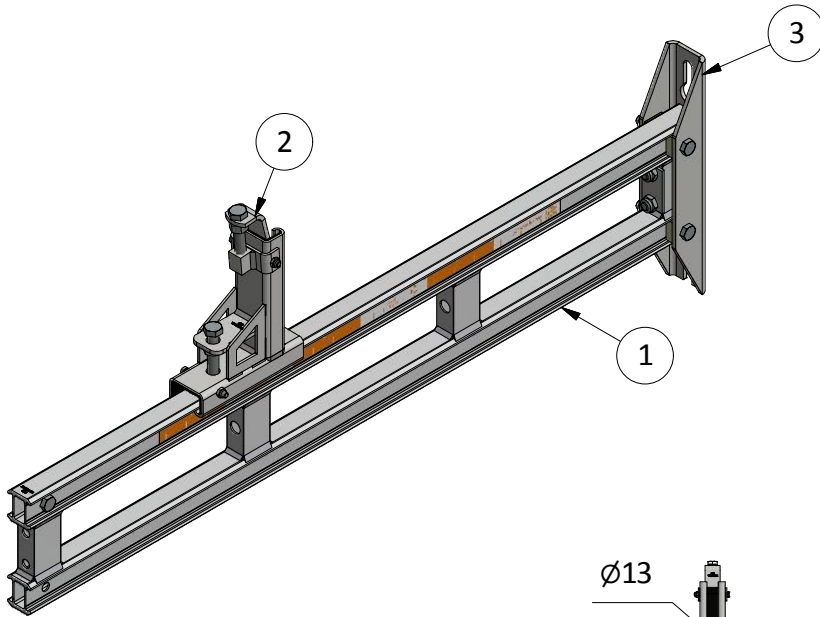

Art nr 9-720-04-015
 5,9 kg
 EN 13374-A
 Max c/c 2,4 m

[mm]

ITEM	QTY	ART. NO
1	1	9-70-000032
2	1	9-720-10-030
3	1	9-720-04-012

