

# PUMPEX P 401 - 3001, PX 12 - 30, PC 1001 - 3001



## SUBMERSIBLE DRAINAGE PUMPS

ENG 50 HZ

POMP DIRECT

**PUMPEX**

Tel. 0294-457712 Fax 0294-457713

### No suction lift limitations

Pumpex drainage pumps are submersible to 20 m depth and have no suction lift limitations. This is superior to any self-priming system due to the fact that the pump is installed submerged in the pit. The pump does not need to be moved with varying water levels and it is designed to run dry in case the water level drops too low. There are no suction hoses, and no vacuum priming issues.

### High reliability

Double mechanical shaft seal in oil bath (silicon carbide on silicon carbide in the primary seal) for long life. Rigid stainless steel shaft with lower double angular contact ball bearings for vibration-free operation. Large strainer area minimizes the risk of clogging.

### Trouble free and safe handling

Pumpex drainage pumps are equipped for immediate use. The low weight, encapsulated motor and no external moving parts makes installation and operation easy and safe.

### High wear resistance

Impeller in high chrome alloy steel with a hardness of 60 Rc. Adjustable wear parts covered with oil resistant nitrile rubber to secure a long lifetime with high efficiency. For extreme conditions choose Pumpex exclusive Enduro Lining™ polyurethane coated wear parts.

### Plug-in start with motor protection

Built-in contactor, capacitor (Single Phase) and thermal protectors in the stator windings protects the motor and features an automatic restart function.

### High flexibility

The pump can operate in every position, vertical, horizontal or even upside down. The pump can easily be converted between standard, high head or high volume versions.

### Corrosion resistant

Outer casing, rotor shaft and hardware are made of stainless steel. Casted parts are made in lightweight aluminium alloy, externally with a protective coating.

### Can run dry

Double outer casing and good heat convection make it possible to run the pump dry or in a snore condition.

### Easy service and maintenance

Common philosophy through the complete range with modular design and interchangeable spare parts. (For example identical shaft seals for P 601-P 801, P 1001-P 3001, PX 12-PX 22.)

- Easy access to separate sealed electrical junction box.
- Easy to adjust or replace hydraulic wear parts.

### Environmentally safe

The oil housing is filled with environmentally safe white oil. Non toxic coatings are used.

### Environmental Product Declaration EPD®

Certified Environmental Product Declaration, EPD®, is a new system to present a products environmental impact during its entire life cycle. All the environmental product declarations are based on product specific life cycle analyses, conducted in accordance with the ISO14040-series.



Reduce the Environmental Impact (LCA):

- 1) Select the right size pump for the application.
- 2) Use at optimum efficiency.
- 3) Keep a high degree of efficiency by replacing wear parts.



**PUMPEX P 401**

**P 401 W**      **1-phase**  
 Motor rating  $P_2$     0.48 kW  
 Max. power input  $P_1$  0.59 kW  
 Electric cable        10 m type H07RN-F  
 Discharge spigots    2"  
                               G 2" BSP-thread  
 Weight (excl. cable) 9.5 kg

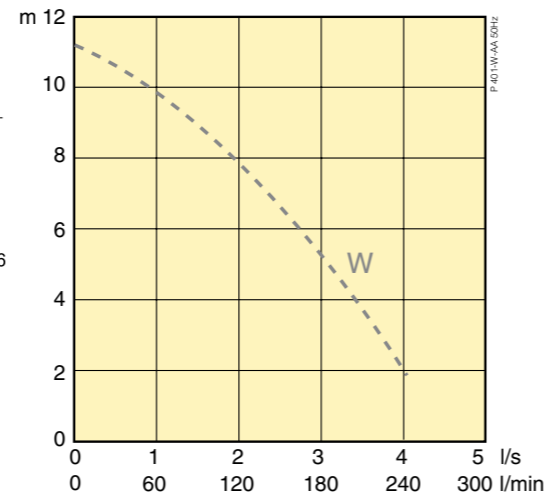
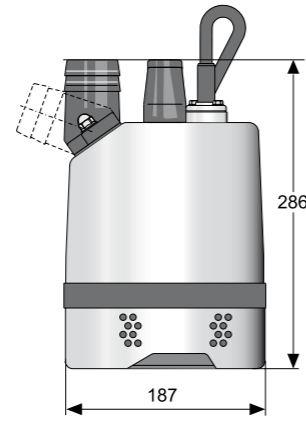
**PUMPEX P 601**

**P 601 W \***      **1-phase**  
**P 601 N \***      **Medium head, 3-phase**  
 Motor rating  $P_2$     1.0 kW (3-phase)  
                               0.9 kW (1-phase)  
 Max. power input  $P_1$  1.3 kW (3-phase)  
                               1.2 kW (1-phase)  
 Electric cable        20 m type H07RN-F  
 Discharge spigots    1½", 2", 2½", 3"  
                               G 2", 2½", 3" BSP-thread  
 Weight (excl. cable) 16 kg

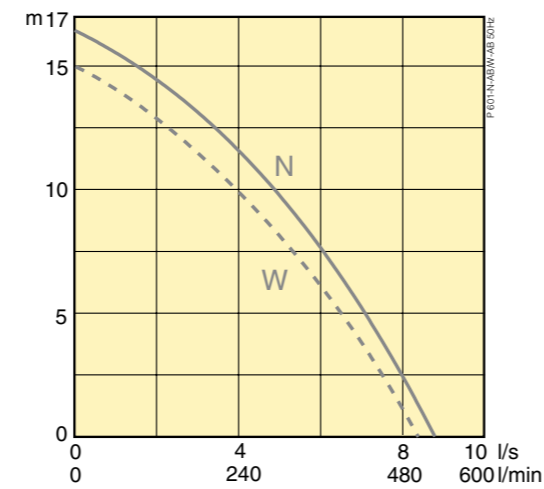
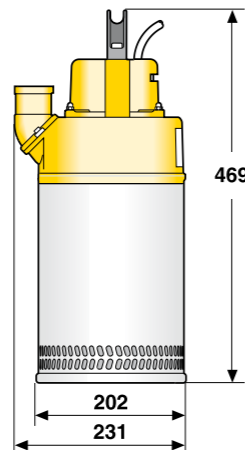

*\*) Built in float switch available as option.*

**PUMPEX P 801**

**P 801 W \***      **1-phase**  
**P 801 N \***      **Medium head, 3-phase**  
 Motor rating  $P_2$     1.4 kW  
 Max. power input  $P_1$  1.8 kW  
 Electric cable        20 m type H07RN-F  
 Discharge spigots    1½", 2", 2½", 3"  
                               G 2", 2½", 3" BSP-thread  
 Weight (excl. cable) 16.5 kg (N)  
                               18 kg (W)

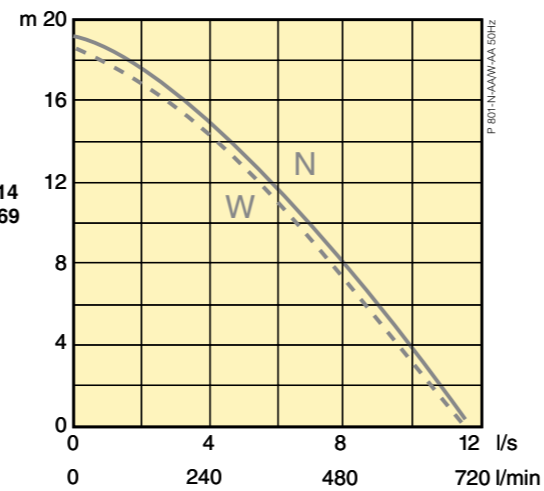
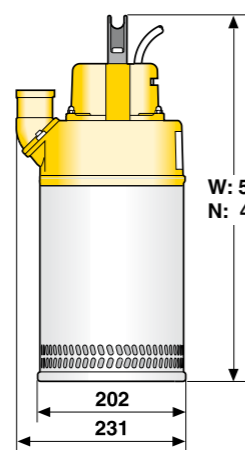

*\*) Built in float switch available as option.*

**PUMPEX P 1001**

**P 1001 N**        **Medium head, 3-phase**  
**P 1001 H**        **High head, 3-phase**  
 Motor rating  $P_2$     2.2 kW  
 Max. power input  $P_1$  3.0 kW  
 Electric cable        20 m type H07RN-F  
 Discharge spigots    2½", 3", 4"  
                               G 2½", 3", 4" BSP-thread  
 Weight (excl. cable) 27 kg

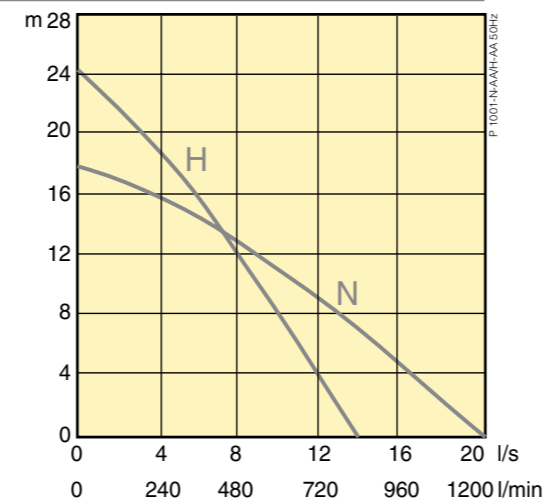
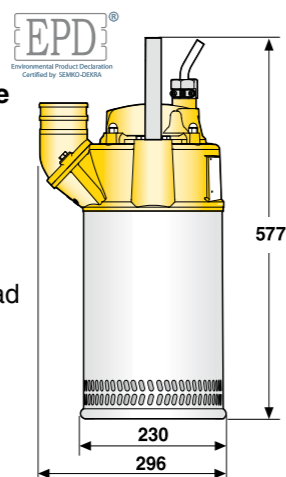

*\*) Enduro Lining™ available as option.*

**PUMPEX P 1501**

**P 1501 N**        **Medium head, 3-phase**  
 Motor rating  $P_2$     4.2 kW  
 Max. power input  $P_1$  5.0 kW  
 Electric cable        20 m type H07RN-F  
 Discharge spigots    2½", 3", 4"  
                               G 2½", 3", 4" BSP-thread  
 Weight (excl. cable) 36 kg

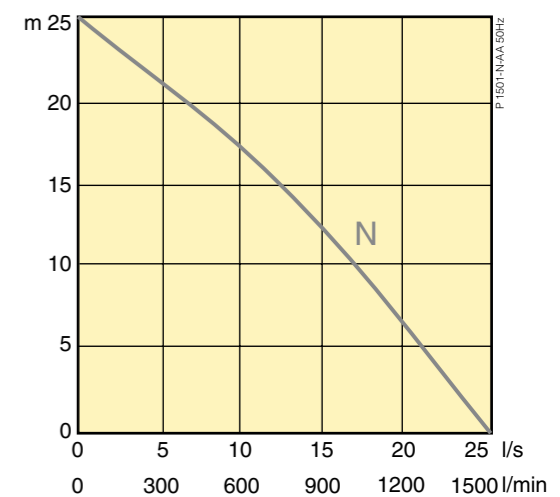
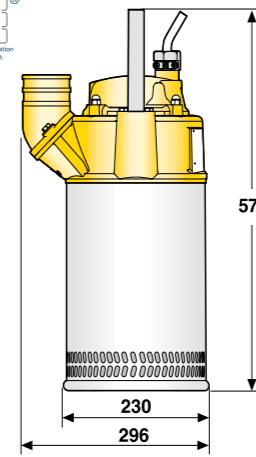

*\*) Enduro Lining™ available as option (N).*

**PUMPEX P 2001**

**P 2001 N**        **Medium head, 3-phase**  
**P 2001 H**        **High head, 3-phase**  
**P 2001 V**        **High flow, 3-phase**  
 Motor rating  $P_2$     5.8 kW  
 Max. power input  $P_1$  6.8 kW  
 Starting                D.O.L. or Star-delta  
 Electric cable        20 m type H07RN-F  
 Discharge spigots    3", 4", 6"  
                               G 3", 4", 6" BSP-thread  
 Weight (excl. cable) 50 kg

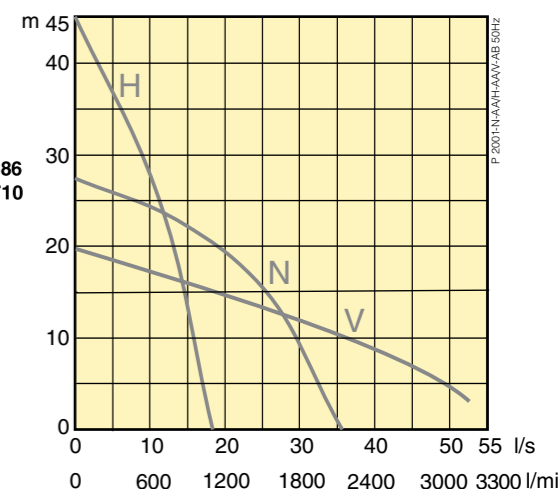
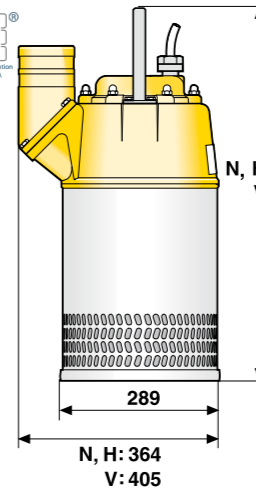

Bottom plate P 2001V:

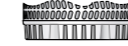

*\*) Enduro Lining™ available as option (N+H).*

**PUMPEX P 3001**

**P 3001 N**        **Medium head, 3-phase**  
**P 3001 H**        **High head, 3-phase**  
**P 3001 V**        **High flow, 3-phase**  
 Motor rating  $P_2$     9.4 kW  
 Max. power input  $P_1$  10.8 kW  
 Starting                D.O.L. or Star-delta  
 Electric cable        20 m type H07RN-F  
 Discharge spigots    3", 4", 6"  
                               G 3", 4", 6" BSP-thread  
 Weight (excl. cable) 70 kg (N, V), 75 kg (H)

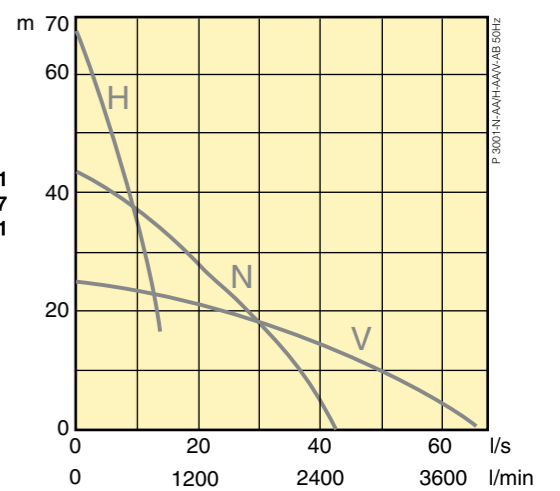
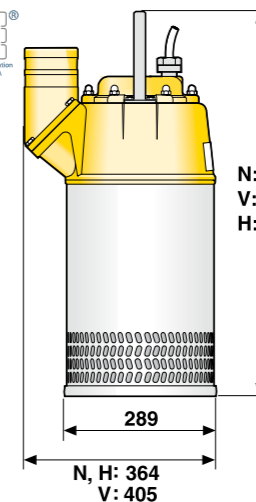

Bottom plate P 3001V:



*\*) Enduro Lining™ available as option (N).*

**PUMPEX PX 12**

**PX 12 N**        **Medium head, 3-phase**  
**PX 12 H**        **High head, 3-phase**  
 Motor rating  $P_2$     21 kW  
 Max. power input  $P_1$  24 kW  
 Starting                D.O.L. or Star-delta  
 Electric cable        20 m type H07RN-F  
 Discharge spigots    4", 6", 8"  
                               G 4", 6", 8" BSP-thread  
 Weight (excl. cable) 155 kg

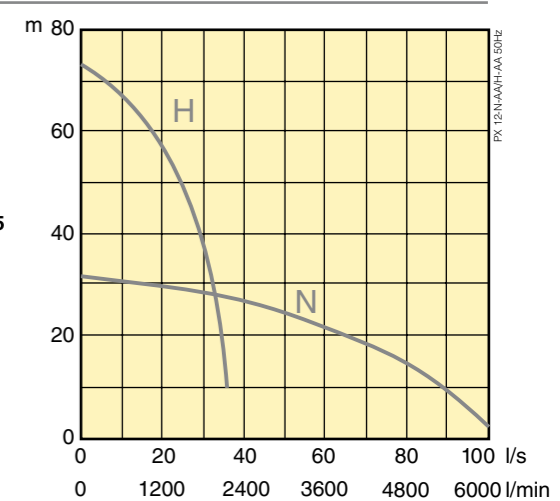
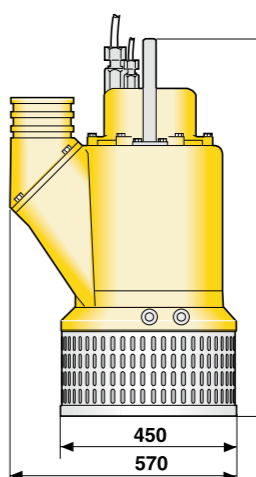

*\*) Enduro Lining™ available as option (H).*

## PUMPEX PX 22 ENDURO LINING \*)

**PX 22 N** Medium head, 3-phase  
**PX 22 H** High head, 3-phase  
 Motor rating  $P_2$  35 kW  
 Max. power input  $P_1$  39.5 kW  
 Starting D.O.L. or Star-delta  
 Electric cable 20 m type H07RN-F  
 Discharge spigots 4", 6", 8"  
 G 4", 6", 8" BSP-thread  
 Weight (excl. cable) 270 kg

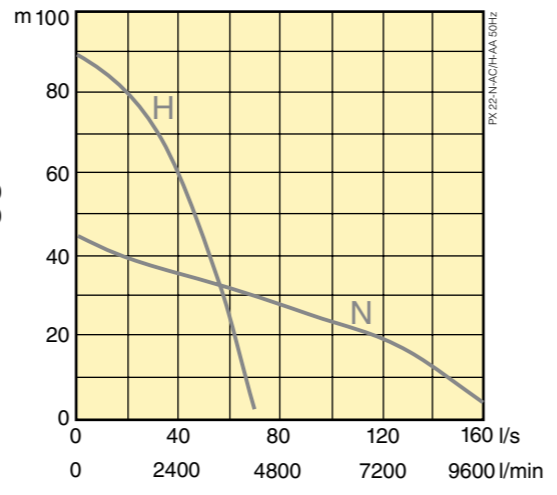
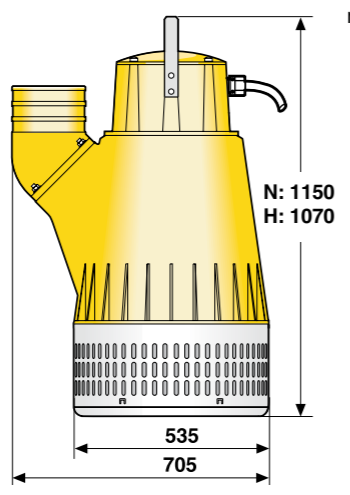

\*) Enduro Lining™ available as option.

## PUMPEX PX 30 ENDURO LINING \*)

**PX 30 N** Medium head, 3-phase  
**PX 30 H** High head, 3-phase  
 Motor rating  $P_2$  56 kW  
 Max. power input  $P_1$  61 kW  
 Starting D.O.L. or Star-delta  
 Electric cable 20 m type H07RN-F  
 Discharge spigots 6", 8", 10"  
 G 6", 8" BSP-thread  
 Weight (excl. cable) 525 kg

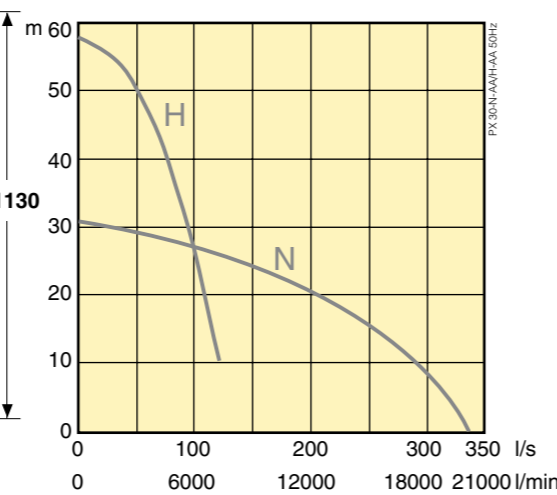
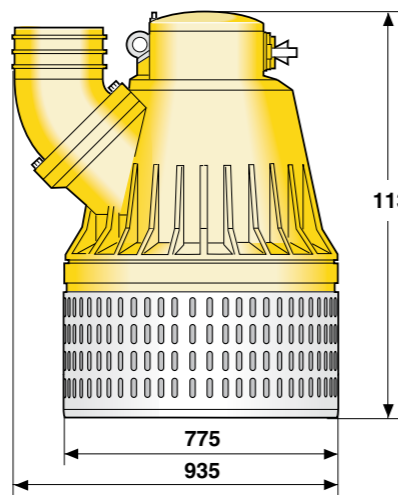

\*) Enduro Lining™ available as option.

## PUMPEX PC 1501 ENDURO LINING \*)

**PC 1501 N** Medium head, 3-phase  
 Motor rating  $P_2$  4.2 kW  
 Max. power input  $P_1$  5.0 kW  
 Electric cable 20 m type H07RN-F  
 Discharge spigots G 3" BSP-thread  
 Weight (excl. cable) 36 kg

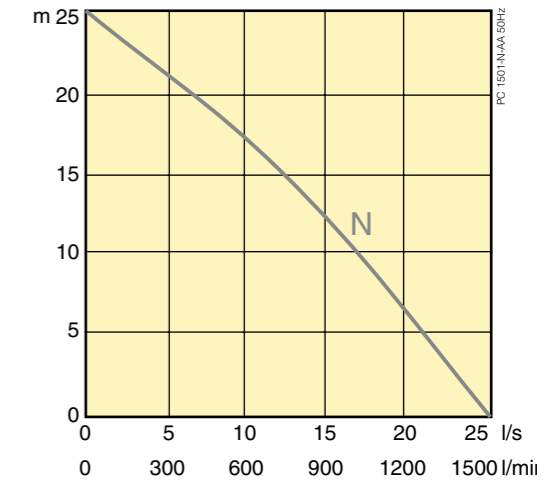
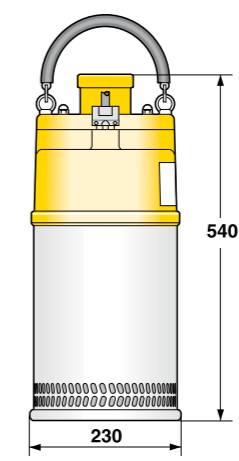

\*) Enduro Lining™ available as option (N).

## PUMPEX PC 2001 ENDURO LINING \*)

**PC 2001 N** Medium head, 3-phase  
**PC 2001 H** High head, 3-phase  
**PC 2001 V** High flow, 3-phase  
 Motor rating  $P_2$  5.8 kW  
 Max. power input  $P_1$  6.8 kW  
 Starting D.O.L. or Star-delta  
 Electric cable 20 m type H07RN-F  
 Discharge spigots G 3", 4" BSP-thread  
 Weight (excl. cable) 50 kg

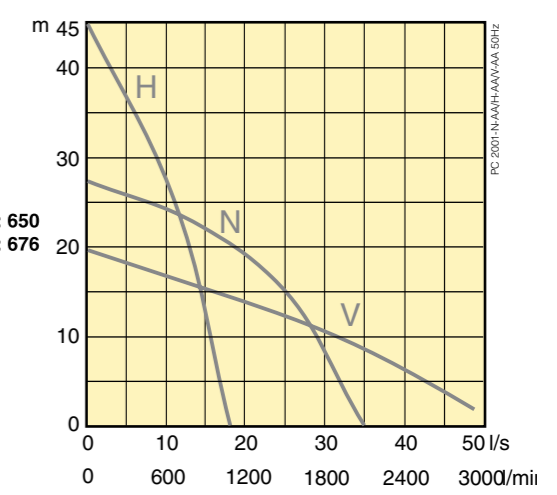
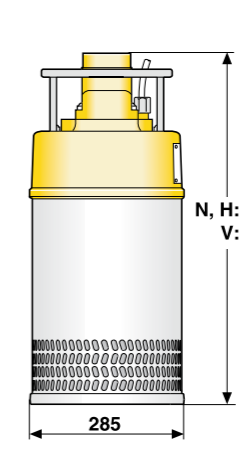

Bottom plate PC 2001V:

\*) Enduro Lining™ available as option (N+H).

Slimline

## PUMPEX PC 1001 ENDURO LINING \*)

**PC 1001 N** Medium head, 3-phase  
**PC 1001 H** High head, 3-phase  
 Motor rating  $P_2$  2.2 kW  
 Max. power input  $P_1$  3.0 kW  
 Electric cable 20 m type H07RN-F  
 Discharge spigots G 3" BSP-thread  
 Weight (excl. cable) 27 kg

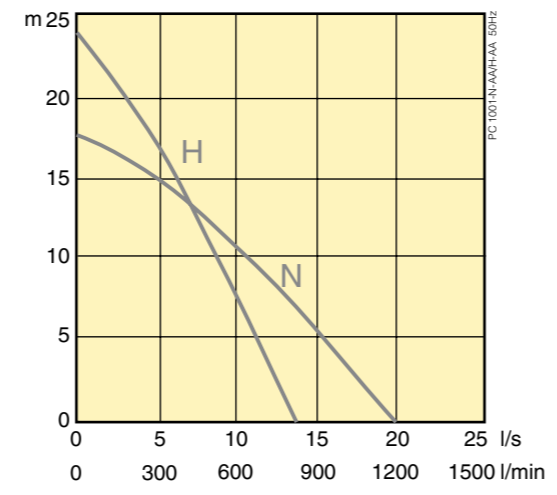
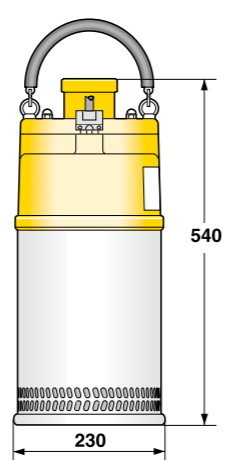

\*) Enduro Lining™ available as option (N+H).

## PUMPEX PC 3001 ENDURO LINING \*)

**PC 3001 N** Medium head, 3-phase  
**PC 3001 V** High flow, 3-phase  
 Motor rating  $P_2$  9.4 kW  
 Max. power input  $P_1$  10.8 kW  
 Starting D.O.L. or Star-delta  
 Electric cable 20 m type H07RN-F  
 Discharge spigots G 3", 4" BSP-thread  
 Weight (excl. cable) 70 kg

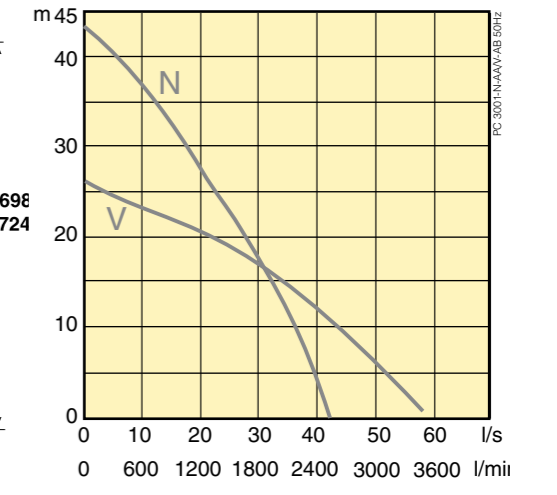
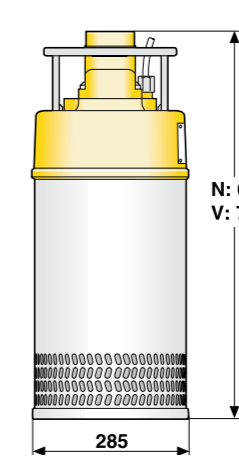

Bottom plate PC 3001V:

\*) Enduro Lining™ available as option (N).

## PUMPEX PC 1301

**PC 1301 N** Medium head, 3-phase  
**PC 1301 H** High head, 3-phase  
 Motor rating  $P_2$  3.0 kW  
 Max. power input  $P_1$  3.8 kW  
 Electric cable 20 m type H07RN-F  
 Discharge spigots 2", 3"  
 G 2", 3" BSP-thread  
 Weight (excl. cable) 31 kg

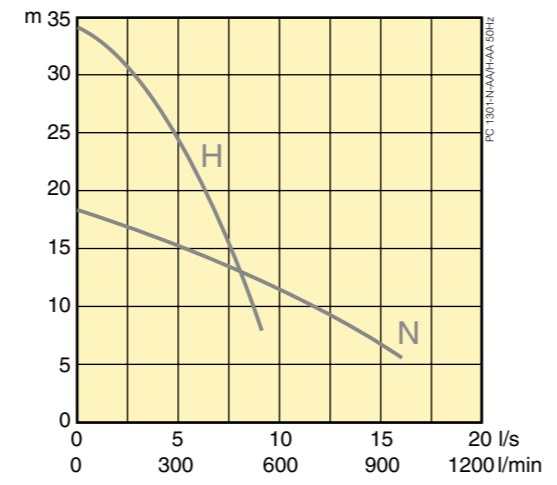
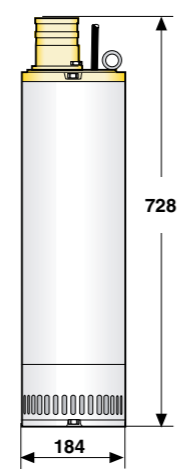

Light duty pump

## PUMPEX GA 200

**GA 200** 1-phase  
 Max. power input  $P_1$  0.46 kW  
 Electric cable 10 m type H07RN-F  
 Discharge spigots 3/4", 1"  
 G 3/4", 1 1/4" BSP-thread  
 Weight (excl. cable) 3.3 kg

