

OPERATOR'S MANUAL



EVOTORQUE®



CONTENTS

Part Numbers Covered by This Manual	2
Description Options	2
Serial Number	2
Safety – General Power Tool Safety Warnings	3
Work Area Safety	3
Electrical Safety	3
Personal Safety	4
Power Tool Use and Care	4
Service	4
Safety – EvoTorque® Specific Safety Warning	5
Markings on Tool	5
EvoTorque® Tools without Reaction Bar	5
Introduction	6
Parts Included	6
Accessories	7
Features and Functions	8
Set Up Instructions	9
Top Handle	9
Torque Reaction	10
Connecting Supply	14
Turn On	15
Menu	16
Set Torque / Angle	17
Set Direction	17
Operating Instructions	18
Tightening	18
Releasing	19
Maintenance	20
Daily Checks	20
Calibration	20
Portable Appliance Testing	20
Gearbox	21
Drive Square	21
Product Disposal	21
Specifications	22
Declaration of Conformity	24
Trouble Shooting	25
Glossary of Terms	26

PART NUMBERS COVERED BY THIS MANUAL

This manual covers the set up and use of Norbar EvoTorque® tools.

Part Number	Model	Torque Range
18165.B06	ET-72-1000-110	200 - 1000 N·m
18151.B06	ET-72-1000-230	200 - 1000 N·m
18166.B06	ET-72-1350-110	270 - 1350 N·m
18152.B06	ET-72-1350-230	270 - 1350 N·m
18167.B08	ET-72-2000-110	400 - 2000 N·m
18153.B08	ET-72-2000-230	400 - 2000 N·m
18169.B08	ET-92-4000-110	800 - 4000 N·m
18155.B08	ET-92-4000-230	800 - 4000 N·m
18171.B12	ET-119-6000-110	1200 - 6000 N·m
18157.B12	ET-119-6000-230	1200 - 6000 N·m

NOTE: The main EvoTorque® models are listed above; other tools with minor variances are also covered.

Description Options

Part Number Option	Description	Options
****.B**	B = Bi-directional	None
****.XX	Drive square size	06 = ¾" A/F. 08 = 1" A/F. 12 = 1½" A/F.

Model Option	Description	Options
ET-***_****_***	ET = EvoTorque®	None
ET-XXX-****_***	Gearbox diameter	72 / 92 / 119
ET-***-XXXX-***	Maximum torque in N·m	1000 / 1350 / 2000 / 4000 / 6000
ET-***_****-XXX	Mains supply voltage	110=110 V a.c. / 230=230 V a.c.



Serial Number

The serial number is in the following format: **YYYYAXXXXX**

Serial Number Code	Description	Options
YYYY*****	Year of manufacture	
****A*****	Month of manufacture	A=January B= February C= March D= April E= May F=June G=July H=August J=September K=October L=November M=December
****XXXXX	Serial number	

NOTE: Due to the manufacturing process, the calibration date may be after the month of manufacture.

SAFETY – GENERAL POWER TOOL SAFETY WARNINGS

Symbol	Meaning
	The lightning flash is intended to alert the user to the presence of uninsulated “dangerous voltage” within the products enclosure that may be of sufficient magnitude to constitute a risk of electric shock to persons.
	The exclamation mark is intended to alert the user to the presence of important operating and maintenance (servicing) instructions in the manual.



WARNING: READ ALL SAFETY WARNINGS AND ALL INSTRUCTIONS. FAILURE TO FOLLOW THE WARNINGS AND INSTRUCTIONS MAY RESULT IN ELECTRIC SHOCK, FIRE AND/OR SERIOUS INJURY.

Save all warnings and instructions for future reference.

The term “power tool” in the warnings refers to your mains-operated (corded) power tool or battery operated (cordless) power tool.

Work Area Safety

- Keep work area clean and well lit. Cluttered or dark areas invite accidents.
- Do not operate power tools in explosive atmospheres, such as in the presence of flammable liquids, gases or dust. Power tools create sparks which may ignite the dust or fumes.
- Keep children and bystanders away while operating a power tool. Distractions can cause you to lose control.

Electrical Safety

- Power tool plugs must match the outlet. Never modify the plug in any way. Do not use any adaptor plugs with earthed (grounded) power tools. Unmodified plugs and matching outlets will reduce risk of electric shock.
- Avoid body contact with earthed or grounded surfaces, such as pipes, radiators, ranges and refrigerators. There is an increased risk of electric shock if your body is earthed or grounded.
- Do not expose power tools to rain or wet conditions. Water entering a power tool will increase the risk of electric shock.
- Do not abuse the cord. Never use the cord for carrying, pulling or unplugging the power tool. Keep cord away from heat, oil, sharp edges and moving parts. Damaged or entangled cords increase the risk of electric shock.
- When operating a power tool outdoors, use an extension cord suitable for outdoor use. Use of a cord suitable for outdoor use reduces the risk of electric shock.
- If operating a power tool in a damp location is unavoidable, use a residual current device (RCD) protected power supply. Use of an RCD reduces the risk of electric shock.
- When performing an operation where the fastener may contact hidden wiring or its own cord, hold power tool by insulated gripping surface (e.g. insulating gloves). Fasteners containing a “live” wire may make exposed metal parts of the power tool “live” and could give the operator an electric shock.

Personal Safety

- Stay alert, watch what you are doing and use common sense when operating a power tool. Do not use a power tool while you are tired or under the influence of drugs, alcohol or medication. A moment of inattention while operating power tools may result in serious personal injury.
- Use personal protective equipment. Always wear eye protection. Protective equipment such as dust mask, non-skid safety shoes, hard hat or hearing protection used for appropriate conditions will reduce personal injuries.
- Prevent unintentional starting. Ensure the switch is in the off-position before connecting to power source and/or battery pack, picking up or carrying the tool. Carrying power tools with your finger on the switch or energising power tools that have the switch on invites accidents.
- Remove any adjusting key or wrench before turning the power tool on. A wrench or a key left attached to a rotating part of the power tool may result in personal injury.
- Do not overreach. Keep proper footing and balance at all times. This enables better control of the power tool in unexpected situations.
- Dress properly. Do not wear loose clothing or jewellery. Keep your hair, clothing and gloves away from moving parts. Loose clothes, jewellery or long hair can be caught in moving parts.
- If devices are provided for the connection of dust extraction and collection facilities, ensure these are connected and properly used. Use of dust collection can reduce dust related hazards.

Power Tool Use and Care

- Do not force the power tool. Use the correct power tool for your application, this will do the job better and safer at the rate for which it was designed.
- Do not use the power tool if the switch does not turn it on or off. Any power tool that cannot be controlled with the switch is dangerous and must be repaired.
- Disconnect the plug from the power source and/or the battery pack from the power tool before making any adjustments, changing accessories or storing power tools. Such preventative measures reduce the risk of starting the power tool accidentally.
- Store idle power tools out of reach of children and do not allow persons unfamiliar with the power tool or these instructions to operate the power tool. Power tools are dangerous in the hands of untrained users.
- Maintain power tools. Check for misalignment or binding of moving parts, breakage of parts and any other condition that may affect operation. If damaged, have the power tool repaired before use. Many accidents are caused by poorly maintained power tools.
- Keep cutting tools sharp and clean. Properly maintained cutting tools with sharp edges are less likely to bind and are easier to control.
- Use the power tool, accessories and tool bits etc. in accordance with these instructions, taking into account the working conditions and the work to be performed. Use of the power tool for operations from those intended could result in a hazardous situation.

Service

- Have your power tool serviced by a qualified repair person using only identical replacement parts. This will ensure that the safety of the power tool is maintained.

SAFETY – EVOTORQUE® SPECIFIC SAFETY WARNING

This tool is intended for use with threaded fasteners.



WARNING: IF NOT USED PROPERLY THIS PRODUCT CAN BE DANGEROUS! THIS PRODUCT CAN CAUSE SERIOUS INJURY TO THE OPERATOR AND OTHERS, THE WARNINGS AND SAFETY INSTRUCTIONS MUST BE FOLLOWED TO ENSURE REASONABLE SAFETY AND EFFICIENCY IN USING THIS PRODUCT. THE OPERATOR IS RESPONSIBLE FOR FOLLOWING THE WARNING AND SAFETY INSTRUCTIONS IN THIS MANUAL AND ON THE PRODUCT.

- Understand the operation of both the TORQUE mode and the ANGLE mode, especially when applied to pre-tightened fasteners. Incorrect tool use can easily apply excessive torque.
- Do not block cooling air entry and exit points.
- Do not pull the mains cable to disconnect from AC outlet, grasp the plug.
- Store tool in carry case after use.
- Isolate the tool from all energy sources before changing or adjusting the drive square socket.
- Always use impact or high quality sockets.
- Use only sockets and adaptors which are in good condition.
- Use only sockets and adaptors which are intended for use with power tools.
- Always operate with a reaction bar that is free to move. Do not fix reaction bar to reaction point.
- For very low torque rate joints (e.g. heat exchangers with long rundown threads) the tool will get warm. In extreme cases the tool safety temperature control will stop the tool.
- It is recommended that Portable Appliance Testing (PAT Testing), officially known as “In-Service Inspection & Testing of Electrical Equipment” is completed at regular intervals, see MAINTENANCE section for more information

Markings on Tool

Pictograms on Tool	Meaning
	WARNING: LIVE PARTS INSIDE. DO NOT REMOVE COVER. NO USER SERVICEABLE PARTS INSIDE.
	Unexpected tool movement due to reaction forces or breakage of drive square or reaction bar may cause injuries. There is a risk of crushing between the reaction bar and work piece. Keep hands away from reaction bar. Keep hand away from tool output.
	Read and understand Operator’s Manual.



EvoTorque® Tools without a Reaction Bar

Upon customer request some EvoTorque® tools are supplied without a reaction bar. These tools MUST NOT be used until a suitable reaction bar has been fitted. Norbar define the reaction bar as ‘interchangeable equipment’ under the European directive 2006/42/EC on Machinery Safety. If applicable a new reaction bar will need to comply with this directive.

INTRODUCTION

The EvoTorque® is an electronic torque tool designed for applying torque to threaded fasteners. There are models to cover torque capacities of 1000 N·m to 6000 N·m. The unique ‘Intelligent Joint Sensing’ technology will accurately tighten to the correct torque without the risk of excess overshoot or undershoot that is common in other electric tools. For fasteners specified in angle, there is an angle mode. Positive confirmation of correct joint tightening is shown on the tool.



Parts Included

Description	Model		
	ET-72	ET-92	ET-119
Maximum Torque	1000 N·m 1350 N·m 2000 N·m	4000 N·m	6000 N·m
Visual Difference			
Cranked Reaction Bar	18494	18936	18961
Reaction Bar Retaining Circlip	26486	26486	26482
Spare Drive Square	18779 (1000 N·m) 19779 (1350 N·m) 18492 (2000 N·m)	18934	-
4mm Hex Key for Drive Square	24953	24953	-
Infill for Top Handle (2 off)	19128	19128	19128
5mm Hex Key for Top Handle	24952	24952	24952
Mains Adaptor (where required)	See table below	See table below	See table below
Operators Manual (with language CD [where required])	34373	34373	34373

Mains Adaptor Part Number									
Mains Voltage	Socket (IEC 60309)	Plug							
		USA	UK	Euro	Italian	Swiss	Danish	Australian	No Plug
110 V	Yellow	39618	-	-	-	-	-	-	39623
230 V	Blue	-	39616	39617	39619	39621	39647	39620	39624

NOTE: The mains adaptors are NOT IP44 rated.

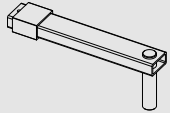
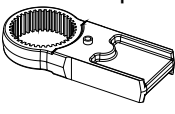
Accessories

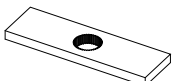
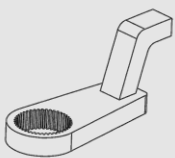
Description	Part Number		
	ET-72	ET-92	ET-119
¾" Drive Square (Fixing Screw)	18779 (25325.45)	-	-
1" Drive Square (Fixing Screw)	18492 (25352.45)	18934 (25352.60)	-
1 ½" Drive Square (Fixing Screw)	-	18935 (25352.60)	18959 (25352.80)
Reaction Bar (NOTE) 	18298	-	-
Reaction Bar Adaptor (NOTE) 	18290	-	-
Single-Sided Reaction Plate 	18292	18979	16687
Double-Sided Reaction Plate 	18293	18980	18981
Splined Reaction 	19289	19291	19293
6" Blade Nose Extension	(1") 18755.006	-	-
9" Blade Nose Extension	(1") 18755.009	-	-
12" Blade Nose Extension	(1") 18755.012	-	-
9" Nose Extension for Truck and Bus Wheels	(¾") 19087.009 (1") 19089.009	-	-
12" Nose Extension for Truck and Bus Wheels	(¾") 19087.012 (1") 19089.012	-	-
Peli Case	26969	26971	26971

NOTE: Requires both "Reaction Bar" and "Reaction Bar Adaptor" to be used together.

Reactions to suit specific applications can be supplied, contact Norbar or a Norbar distributor for details.

FEATURES AND FUNCTIONS

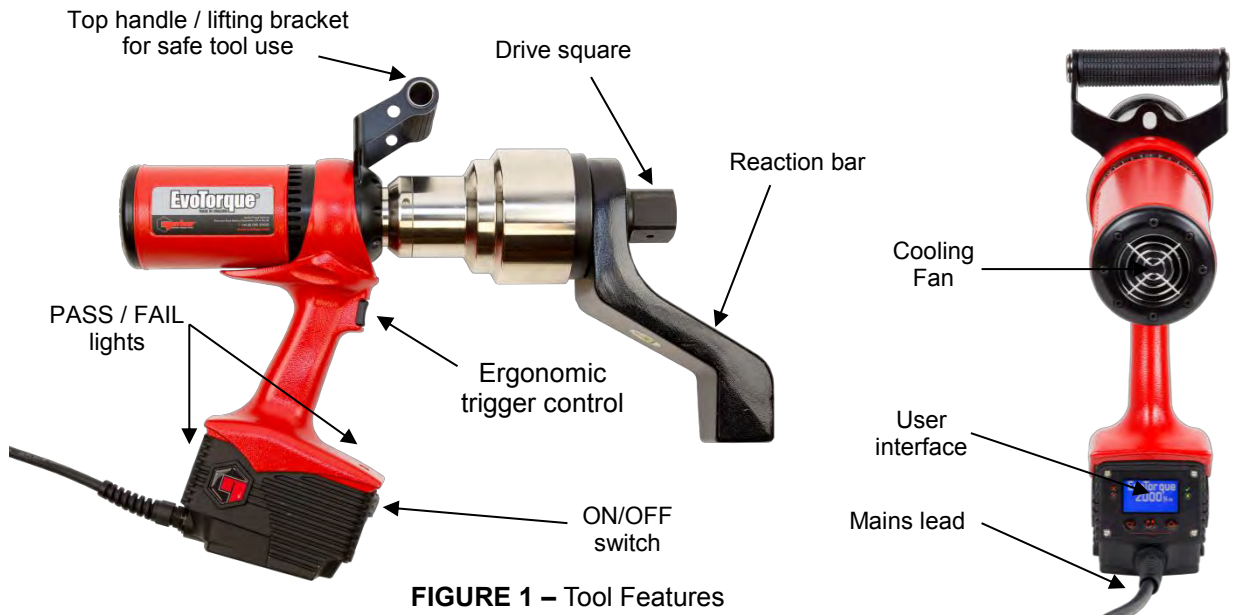

FIGURE 1 – Tool Features

- Factory calibrated to $\pm 3\%$.
- Using patent pending “Intelligent Joint Sensing” technology to continually measure the joint during tightening. As the fastener is tightened the tool will sense the joint type (hard / soft) and act accordingly. As the fastener is tightened dynamic braking is used to ensure the target torque is correctly reached and eliminate the potential for a large over torque due to tool inertia.
- Models covering 5 torque ranges up to 6000 N·m.
- Very quiet operation.
- Very low vibration levels using a non-impacting mechanism; this leads to comfortable and safe use with less damage to the tool, socket and threaded assembly.
- IP44 environmental rating (protection against 1mm solid objects & splashing water).
- Versions for 110 V a.c. or 230 V a.c.
- Reaction forces are contained by the reaction bar, so forces are not passed back to the operator.
- Several reaction bar styles available, including versions for restricted applications.
- Torque mode & Angle mode.
- Tool calibrated from 20% to 100% of rated torque capacity.
- Brushless motor for low maintenance.

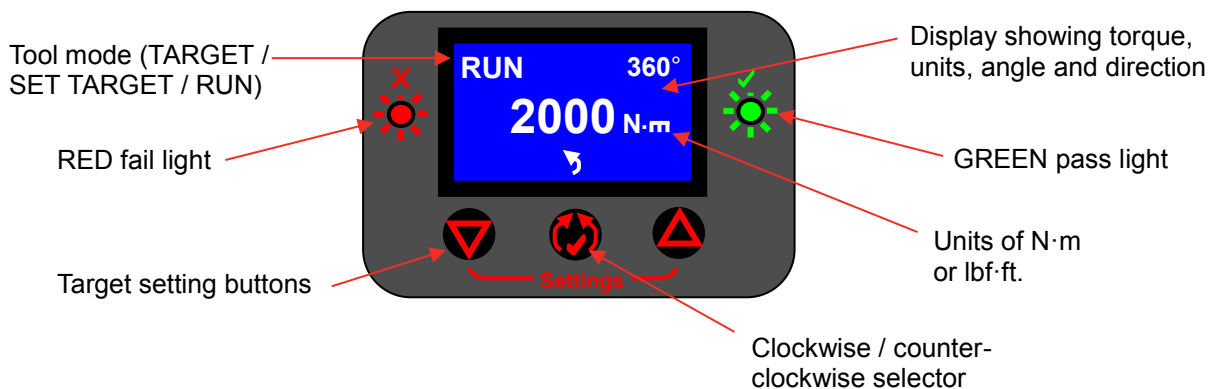

FIGURE 2 – User Interface Features

SET UP INSTRUCTIONS

NOTE: If the equipment is used in a manner not specified by the manufacturer, the protection provided by the equipment may be impaired.



WARNING: ALLOW THE TOOL TO EQUALISE TO THE AMBIENT TEMPERATURE / HUMIDITY BEFORE SWITCHING ON. WIPE OFF ANY MOISTURE BEFORE USE.

Please complete the set up in the order shown.

Top Handle

The tool is supplied with a top handle attached to the tool. For hand held use it is recommended to always use the top handle as loss of tool control can cause personal injury. If a hangar (balancer) is required, attach to top handle.

Should the top handle not be required it can be removed as follows:

1. Use 5mm hex key (supplied) to remove fixing bolts, see figure 3, then remove handle

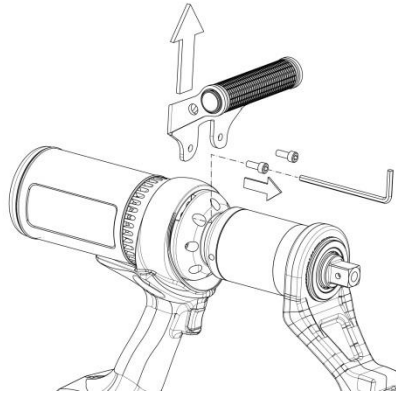

FIGURE 3 – Removal of Top Handle

2. Install two infills (supplied) then re-fit bolts; see figure 4.
The infills must be fitted to maintain the tool's environmental rating.

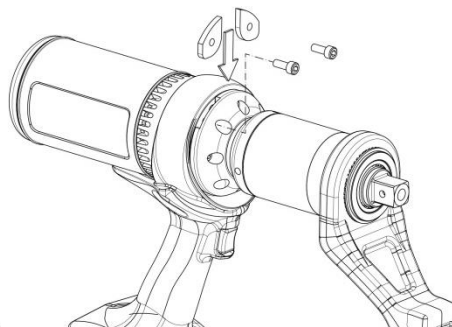



FIGURE 4 – Install infills

Torque Reaction

The reaction bar ensures all reaction forces are contained, so torque reaction is not passed back to the operator. Several reaction bar styles are available.

Fit reaction bar as detailed below.

Reaction Bar Type	Fitting Instructions
Cranked Reaction Bar (Standard) Single Sided Reaction Plate (Option) Double Sided Reaction Plate (Option)	Fit reaction bar / plate over the drive square to engage reaction splines. Secure with circlip supplied.
Nose Extension (Option)	Fit as instructions supplied with nose extension. <div style="text-align: center;">  <p>FIGURE 5 – Nose Extension</p> </div>

It is essential the reaction bar rests squarely against a solid object or surface adjacent to the fastener to be tightened.

DO NOT react on the surface circled in red on figure 6.

React on the end of the reaction bar, circled in green on figure 6, using the maximum area possible.



FIGURE 6 – Reaction Bar Surface

The ideal reaction arrangement has the centre of the reaction bar and the centre of the nut on a perpendicular line to the centre line of the tool, see figure 7.

The supplied reaction bar has been designed to give an ideal reaction point when used with a standard length socket.

To allow for a small difference in socket length the reaction bar may contact any point within the shaded area of figure 7.

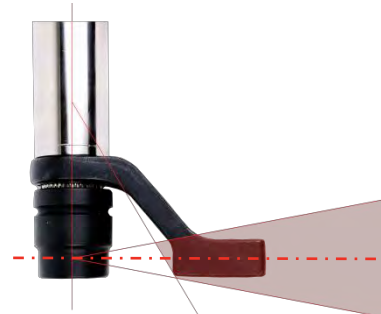

FIGURE 7 – Standard Length Socket Safe Reaction Window



WARNING: IF THE REACTION POINT IS OUTSIDE THE SHADED AREA EXCESSIVE LOADS MAY BE PLACED ON THE TOOL LEADING TO POTENTIAL OPERATOR INJURY AND DAMAGE TO THE TOOL.

If an extra long socket is used it may move the reaction bar outside the safe reaction window, as seen in figure 8.

The standard reaction bar may need to be extended to ensure it remains within the shaded area.

For alternative reaction bars see ACCESSORIES list.



FIGURE 8 – Extra Long Socket Safe Reaction Window



WARNING: IF MODIFYING THE STANDARD REACTION BAR ENSURE IT IS CAPABLE OF TAKING THE MAXIMUM LOAD OF THE TOOL. FAILURE OF THE REACTION BAR CAN ENDANGER OPERATOR SAFETY AND DAMAGE THE TOOL.

Standard drive square extensions, see figure 9, **MUST NOT** be used as these will cause serious damage to the tool output drive.

A range of nose extensions is available for applications where access is restricted. These are designed to support the final drive correctly.



FIGURE 9 – Drive Square Extension

The dimensions of the standard reaction bars are shown in the following table:

Cranked Reaction Bar (Supplied)	Tool	'L'	'A'	'B'	'W'	'SQ'
	ET-72	75	165	91	48	3/4" or 1"
	ET-92	98.5	205	115	50	1"
	ET-119	127	199	65	55	1 1/2"

FIGURE 10 – Reaction Bar

Blade Nose Extension (Optional Accessory)	Tool	'L'	'A'	'B'	'W'	'SQ'
	ET-72 (1000 N·m)	80.5	110	63	12	3/4"
	ET-92 (2000 N·m)	51.5	110	62	16	1"

FIGURE 11 – Blade Nose Extension



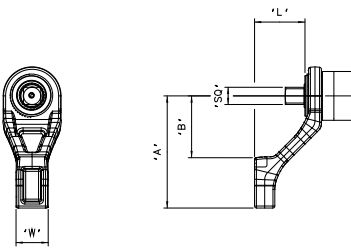

Nose Extension for Truck and Bus Wheels (Optional Accessory)	L	A	B	C	ØD	ØE	SQ
	98	47	132.5	29	52	38	3/4" or 1"

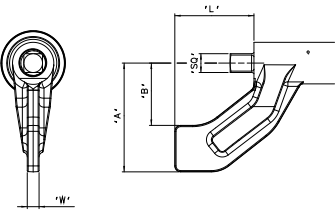
FIGURE 12 – Nose Extension for Truck and Bus Wheels

When the EvoTorque[®] is in operation the reaction bar rotates in the opposite direction to the output drive square and must be allowed to rest squarely against a solid object or surface adjacent to the fastener to be tightened. (See figure 13 - 16).

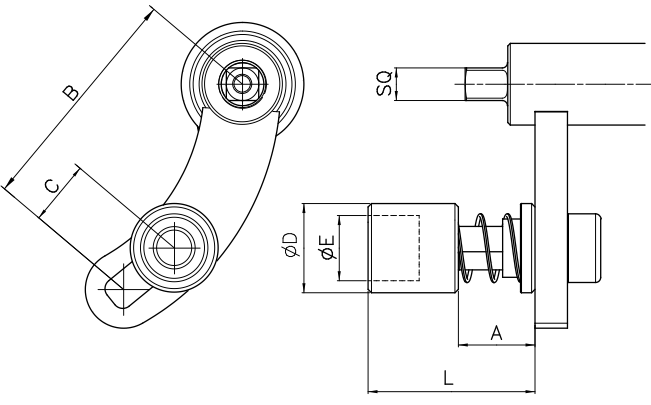
EvoTorque [®] Type	Torque Reaction	
	Clockwise	Counter – Clockwise
Example of EvoTorque [®] Tool	 <p>FIGURE 13</p>	 <p>FIGURE 14</p>
Example of EvoTorque [®] tool with nose extension option	 <p>FIGURE 15</p>	 <p>FIGURE 16</p>



WARNING: ALWAYS KEEP HANDS CLEAR OF THE REACTION BAR WHEN THE TOOL IS IN USE OR SERIOUS INJURY MAY RESULT.



Connecting Supply



WARNING: THE TOOL HAS BEEN DESIGNED FOR ONE VOLTAGE ONLY. CHECK THAT THE POWER SUPPLY CORRESPONDS TO THE VOLTAGE ON THE TOOL RATING PLATE.



WARNING: THE TOOL MUST BE EARTHED ENSURE POWER SUPPLY HAS AN EARTH DO NOT OPERATE WITHOUT AN EARTH



WARNING: FOR OPERATOR SAFETY ENSURE THE MAINS SUPPLY HAS A RESIDUAL CURRENT DEVICE (RCD). TEST THE RCD REGULARLY.

Connect plug to local mains supply.

TIP: Supply Circuit Breaker:

If the mains supply is fitted with a circuit breaker ensure it is TYPE C (as defined in IEC / EN 60898-1) or above to eliminate false trips.

To maintain the environmental rating the tool has been factory fitted with a suitable plug to IEC 60309.

The plug will either be coloured blue (for 230 V a.c. models) or yellow (for 110 V a.c. models).

It is important to connect directly to a local supply socket outlet of the same type.

TIP: Use of a Different Local Supply Socket:

The tool is supplied with a plug rated to IEC 60309 for industrial locations.

An adaptor (where supplied) can be used to convert to a non-industrial plug; see INTRODUCTION for plug options.

Should a different plug be required, the mains cable colours are:

BROWN-LIVE

BLUE-NEUTRAL

GREEN/YELLOW-EARTH

The new plug must have a ground (**EARTH**) connection.

Ensure the plug is rated for voltage/current of tool.

If in doubt consult a qualified electrician.

TIP: Using an Extension Cable:

If an extension cable is required, use an approved extension cable suitable for the power input of this tool. The minimum conductor size is 1.5 mm². When using the cable reel, always unwind the cable completely.

Turn On

Turn on mains supply.

Change ON/OFF switch from 0 to I.

The logo is shown for 2 seconds:

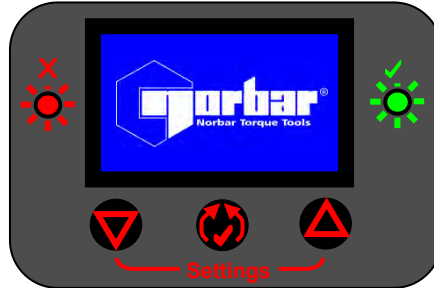

FIGURE 17 – Norbar Logo

The capacity is shown for 2 seconds:



FIGURE 18 – Tool Capacity

TIP: Fan operation:
During the logo & capacity screens the fan will run to give confirmation it is working.

The target screen is shown:



FIGURE 19 – Target Torque



FIGURE 20 – Target Angle

The tool mode, target torque, target angle and direction are remembered from the last use.

TIP: The tool operation is shown in the top left corner:



TARGET – Tool ready to use.

SET – Tool target is being set.

RUN – Tool is running.

Menu

This menu is used to set or view the mode, units, lock, fan, contrast, temperature and software.

To enter the menu press  (DOWN) and  (UP) buttons at the same time.

If  appears enter PIN code.

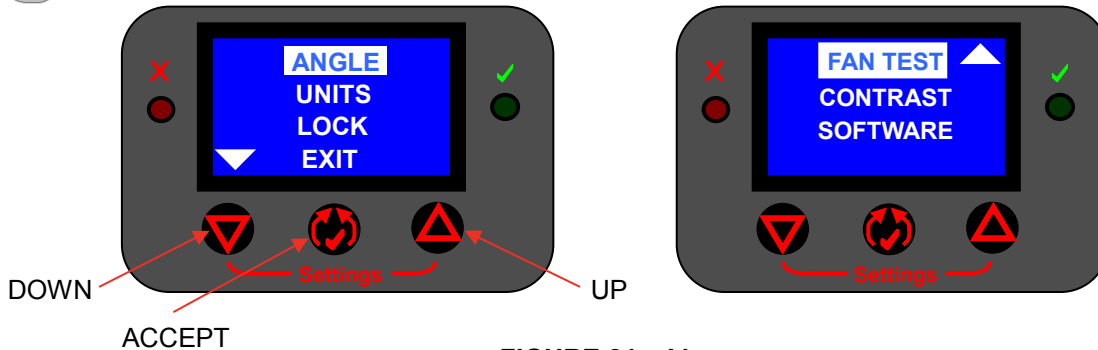











FIGURE 21 – Menu

Use  &  to select. Use  to accept.

Menu Option	Details
ANGLE	Select <input type="checkbox"/> for torque mode (no angle). Select <input checked="" type="checkbox"/> for angle mode.
UNITS	Select N·m or lbf·ft.
LOCK	Select unlock  or lock  The existing code is shown “PIN = 5000”, set 0000 to 9999. TIP: Keep a note of the pin code in a safe place In use a wrong PIN shows  & correct PIN shows 
EXIT	Exit from menu.
FAN TEST	Press and hold  or  to test fan.
CONTRAST	Adjust as required.
SOFTWARE	“M=30.xxx” = Motor software version and “D=31.xxx” = Display software version.

NOTE: If the ANGLE mode has been changed, on exit the display will be in “SET” to confirm the target.

Set Torque / Angle

Set Torque (Angle mode =)

Press  to decrease torque.

Press  to increase torque.

“SET” is shown on the display.
The torque value is shown in INVERSE colour.

When set press  to accept.

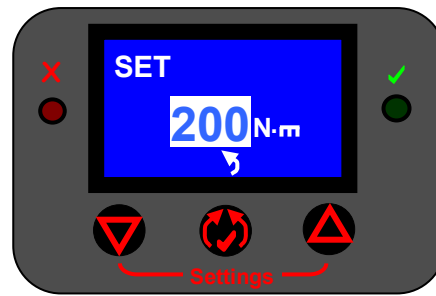



FIGURE 22 – Set Torque

Set Torque & Angle (Angle mode =)

Press  to decrease torque.

Press  to increase torque.

“SET” is shown on the display.
The torque value is shown in INVERSE colour.

When set press  to accept.

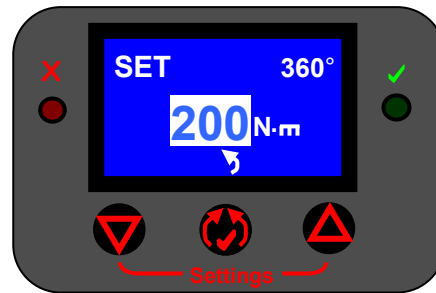



FIGURE 23.a – Set TORQUE & ANGLE

Press  to decrease angle.

Press  to increase angle.

“SET” is shown on the display.
The angle value is shown in INVERSE colour.

When set press  to accept.



FIGURE 23.b – Set TORQUE & ANGLE

TIP: Keep button pressed to increase rate of target change.
When close to target, release button then press again to slow rate of change.

Set Direction

Press  to set direction.

The tool is now ready to use.

OPERATING INSTRUCTIONS



WARNING: KEEP HANDS CLEAR OF THE REACTION BAR.



WARNING: WHEN USING THIS TOOL IT MUST BE SUPPORTED AT ALL TIMES IN ORDER TO PREVENT UNEXPECTED RELEASE IN THE EVENT OF FASTENER OR COMPONENT FAILURE.

Tightening

1. Fit the tool with the correct size impact or high quality socket to suit fastener.

TIP: For added safety it is recommended to secure the socket to the drive square. This is often achieved using a pin and O ring, see socket manufacturer for guidance.

2. Ensure the Clockwise/Counter-clockwise display arrow is correct.

Press  to set direction.

3. Ensure mode (Torque or Angle) is correct.
4. Ensure target torque / angle shown is correct.

In Torque mode the tool applies torque until the target torque is achieved.

Angle mode is achieved in 2 steps, see figure 24:

- 4.1. The tool applies a torque.
Ensure fastener has been pre-torqued above this value.
- 4.2. The tool applies the target angle.

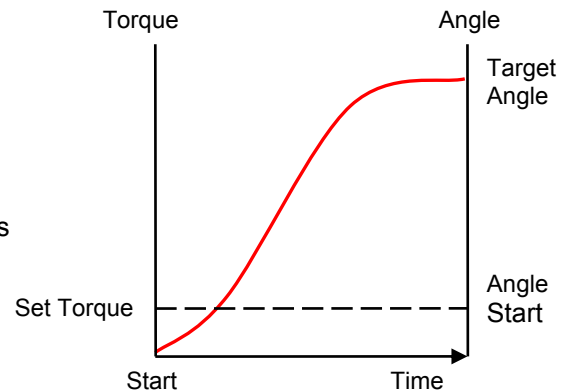

FIGURE 24 – Angle Mode

5. Rotate the handle into a convenient position relative to the reaction bar. Fit the tool onto the fastener to be tightened with the reaction bar adjacent to the reaction point. See figure 25.
6. Adopt a posture to counteract normal or unexpected movement of the tool due to reaction forces.
7. Press and release trigger to slowly bring reaction bar into contact with the reaction point.

NOTE: Bringing into contact at speed can lead to increased operator danger, fastener damage, reaction point damage and torque inaccuracies especially on high torque rate joints.



FIGURE 25 – Clockwise Operation

8. Fully press the trigger and keep fully pressed until tool stops, then release trigger.

- Joint complete. See lights on display & front of tool for pass / fail status. If in Angle mode the angle achieved is shown.

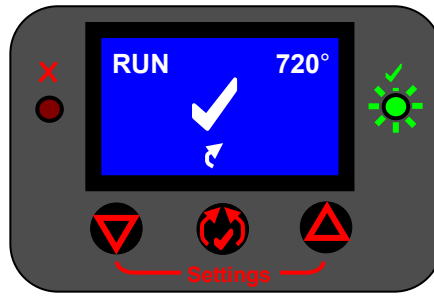

FIGURE 26 – Successful joint. Tick and green led shown.

LED Status	Meaning	Delay To Next Run	Action
✓	Fastener tightened to specification.	2 seconds	None
✗	Fastener NOT tightened to specification.	2 seconds	Release fastener and re-tighten

- Remove the tool from the fastener.

TIP: When tightening multiple fasteners on a flange it is recommended to mark each fastener when tight.

This is even more important when using the TORQUE & ANGLE mode as applying additional angle to a tightened fastener will increase the risk of operator danger, fastener damage and flange damage.

Releasing

- Fit the EvoTorque® with the correct size impact or high quality socket to suit the fastener to be released.

TIP: For added safety it is recommended to secure the socket to the drive square. This is often achieved using a pin and O ring, see socket manufacturer for guidance.

- Ensure the clockwise/counter-clockwise display arrow is correct.

Press to set direction.

- Rotate the handle into a convenient position relative to the reaction bar. Fit the tool onto the fastener to be released with the reaction bar adjacent to the reaction point. See figure 27.

- Adopt a posture to counteract normal or unexpected movement of the tool due to reaction forces.
- Press and release trigger to slowly bring reaction bar into contact with the reaction point.
- Fully press the trigger and keep fully pressed until the threaded fastener releases.



FIGURE 27 – Anti-Clockwise Operation

TIP: If unable to release the fastener, increase the target torque. The tool will automatically limit itself to the maximum tool output torque.

MAINTENANCE



WARNING: ENSURE THE TOOL IS DISCONNECTED FROM MAINS SUPPLY BEFORE MAINTENANCE.

For optimum performance and safety, regular tool maintenance is required. The user maintenance is limited to that stipulated in this section. Any other maintenance or repairs should be carried out by Norbar or a Norbar distributor. Maintenance intervals will depend on the tool usage and the environment in which it is being used. The maximum recommended maintenance and recalibration interval is 12 months.

TIP: Steps the user can take to reduce the amount of maintenance required include:

- 1. Use the tool in a clean environment**
- 2. Maintain the correct torque reaction**
- 3. Carry out daily checks**

Daily Checks

It is recommended to check the overall condition of the tool every day.

Check power cord for damage – if faulty contact Norbar or Norbar distributor.

Ensure PAT test on tool is within date.

Test the external RCD in the mains supply (if fitted).

Ensure tool is clean - DO NOT use abrasives or solvent based cleaners.

Ensure fan and ventilation slots are clean and dust free. If cleaned with compressed air wear eye protection.

Free run tool to ensure motor and gearbox are smooth and quiet.

Calibration

Your tool has been supplied with a certificate of calibration.

To maintain the specified accuracy it is recommended that the tool is recalibrated at least once per year.

Recalibration should be carried out at Norbar or by a Norbar distributor, where all the facilities to ensure the instrument is functioning at maximum accuracy are available.

Do not remove tool casing; there are no calibration settings inside.

Portable Appliance Testing

Portable Appliance Testing (PAT testing) is officially known as “In-service Inspection & Testing of Electrical Equipment”.

This is often a mandatory requirement in local regulations or factory procedures.

The tests are to ensure that the equipment has not suffered damage or faults in the electrical connections that could cause potential danger to the operator.

A competent person should inspect then test the tool for earth continuity (Earth Bond) and Insulation resistance (Electric Strength); other tests may apply.

The frequency of test will depend on many factors including the tool application and environment.

Gearbox

Under normal operating conditions it is not necessary to re-grease the gearbox. The gearbox contains Lubcon Turmogrease Li 802 EP.

Drive Square

If the tool output drive is subject to torque overload there is potential for catastrophic tool damage. To reduce this risk the output drive square has been designed, like a fuse, so it will shear first. The output drive square is easy and quick to replace, for part numbers see ACCESSORIES listed in the INTRODUCTION. The drive square is NOT covered by the standard product warranty.



FIGURE 28 – Drive Square Replacement

To replace the drive square:

1. Unplug tool from mains supply.
2. Support tool in a horizontal position
3. Use 4mm hex key (supplied) to remove the screw and then remove drive square.
If the square has sheared it may be necessary to use pliers to remove the broken parts.
4. Fit new drive square.
5. Fit new screw. Tighten to 9 N·m (M5).

TIP: If the drive square fails continually then seek advice from Norbar or a Norbar distributor.

Product Disposal



This symbol on the product indicates that it must not be disposed of in the general waste.

Please dispose of according to your local recycling laws and regulations. Contact your distributor or see the Norbar website (www.norbar.com) for further recycling information.

SPECIFICATIONS

Part Number	Torque		Tool Speed* (Free Running)	Tool Weight (kg)	Reaction Weight (kg)	Case & Ancillaries (kg)
	Minimum	Maximum				
18165.B06 18151.B06	200 N·m	1000 N·m	21 rpm	10.4	0.7	6.0
18166.B06 18152.B06	270 N·m	1350 N·m	17 rpm	10.4	0.7	6.0
18167.B08 18153.B08	400 N·m	2000 N·m	11 rpm	10.8	0.7	6.0
18169.B08 18155.B08	800 N·m	4000 N·m	6 rpm	12.85	1.35	6.0
18171.B12 18157.B12	1200 N·m	6000 N·m	3.3 rpm	16.8	2.1	6.0

* = Tool speed is reduced for Angle mode and for lower capacity targets.

Part Number	Dimensions (mm)					
	B	C	D	E	F	G
18165.B06 18151.B06	390	435	75	72	100	135.5
18166.B08 18152.B06	390	435	75	72	100	135.5
18167.B08 18153.B08	425	435	75	72	100	135.5
18169.B08 18155.B08	450	435	98.5	92	100	135.5
18171.B12 18157.B12	480	435	127	119	115	135.5

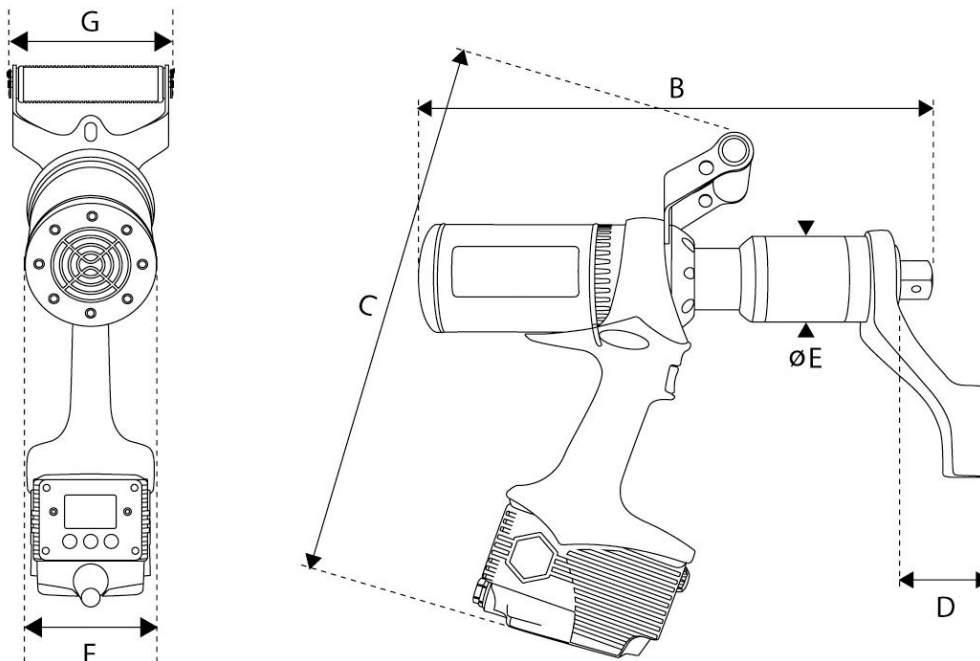

FIGURE 29 – Tool Dimensions

Torque Accuracy:	±3% of target torque on 100° joint (see calibration certificate).
Torque Setting:	20% to 100% of tool capacity.
Angle Accuracy:	±2°.
Angle Setting:	10° to 720°.
Angle Start Threshold:	10% to 100% of tool capacity.
Vibration:	The vibration total value does not exceed 2.5m/s ² . Highest measured tool vibration $a_h = 0.304 \text{ m/s}^2$. The declared vibration total value has been measured in accordance with a standard test method and may be used for comparing one tool with another. The declared vibration total value may also be used in a preliminary assessment of exposure.



WARNING: THE VIBRATION EMISSION DURING ACTUAL USE OF THE POWER TOOL CAN DIFFER FROM THE DECLARED TOTAL VALUE DEPENDING ON THE WAYS IN WHICH THE TOOL IS USED.



WARNING: IDENTIFY SAFETY MEASURES TO PROTECT THE OPERATOR THAT ARE BASED ON AN ESTIMATION OF THE EXPOSURE IN THE ACTUAL CONDITIONS OF USE (TAKING ACCOUNT OF ALL PARTS OF THE OPERATING CYCLE SUCH AS THE TIMES WHEN THE TOOL IS SWITCHED OFF AND WHEN IT IS RUNNING IDLE IN ADDITION TO THE TRIGGER TIME).

Sound Pressure Level:	L_{pA} does not exceed 70 dB(A).
Ingress Protection:	IP44 (Protection against 1mm solid objects & splashing water) see EN 60529.
Environment:	Industrial. Store in a clean and dry environment.
Temperature Range:	-20°C to +50°C (operating). -20°C to +60°C (storage).
Operating Humidity:	85% Relative Humidity @ 30°C maximum.
Voltage Requirement:	110 V a.c. (99-132 V a.c.) or 230 V a.c. (198-264 V a.c.) at 50-60Hz, see Tool Rating Plate.
Current Requirement:	10A (for 110 V a.c. tools) or 5A (for 230 V a.c. tools).
Fuse fitted:	15A (for 110 V a.c. tools) or 12A (for 230 V a.c. tools).

Due to continuous improvement all specifications are subject to change without prior notice.

NOTE: If equipment is used in a manner not specified by the manufacturer, the protection provided by the equipment could be impaired.



Norbar Torque Tools Ltd
 Beaumont Road | Banbury | Oxfordshire OX16 1XJ | UK
 T +44 (0)1295 270333 | F +44 (0)1295 753643
 E enquiry@norbar.com | www.norbar.com

Declaration of Conformity

The following products:

EvoTorque®

Model Name (Part Number):	ET-72-1000-110 (18165.B06)	ET-72-1000-230 (18151.B06)
	ET-72-1350-110 (18166.B06)	ET-72-1350-230 (18152.B06)
	ET-72-2000-110 (18167.B08)	ET-72-2000-230 (18153.B08)
	ET-92-4000-110 (18169.B08)	ET-92-4000-230 (18155.B08)
	ET-119-6000-110 (18171.B12)	ET-119-6000-230 (18157.B12)

Are in compliance with the protection requirements of the following directives:

Machinery Directive 2006/42/EC.
 EMC (Electromagnetic compatibility) 2004/108/EC.

The following standards have been applied:

BS EN 60745-1:2009 + A11: 2010	Hand-held motor-operated electric tools. Safety. General requirements.
BS EN 60745-2-2:2010	Hand-held motor-operated electric tools. Safety. Part 2: Particular requirements for screwdrivers and impact wrenches.
BS EN 61000-3-2:2006 + A2: 2009	Electromagnetic compatibility (EMC). Limits. Limits for harmonic current emissions (equipment input current ≤16 A per phase).
BS EN 61000-3-3: 2008	Electromagnetic compatibility (EMC). Limits. Limitation of voltage changes, voltage fluctuations and flicker in public low-voltage supply systems, for equipment with rated current ≤ 16 A per phase and not subject to conditional connection.
BS EN 61000-6-2: 2005	Electromagnetic compatibility (EMC). Generic standards. Immunity standard for industrial environments.
BS EN 61000-6-4: 2007 + A1: 2011	Electromagnetic compatibility (EMC). Generic standards. Emission standard for industrial environments.

The basis on which conformity is being declared:

This declaration of conformity is issued under the sole responsibility of the manufacturer. The technical documentation required to demonstrate that the products meet the requirements of the above Directives has been compiled by the signatory below and is available for inspection by the relevant enforcement authorities.

The object of the declaration described above is in conformity with Directive 2011/65/EU of the European Parliament and of the Council of 8 June 2011 on the restriction of the use of certain hazardous substances in electrical and electronic equipment.

The CE mark was first applied in: 2013.

Signed: *T.M. Lester* **Full Name:** Trevor Mark Lester B.Eng.
Date: 9th October 2013 **Authority:** Compliance Engineer
Place: Norbar Torque Tools Ltd., Beaumont Road, Banbury, Oxfordshire. OX16 1XJ





United Kingdom | Australia | United States of America
 New Zealand | Singapore | China | India



Registered in England No 380480 | VAT No GB 110 1000 05

TROUBLE SHOOTING

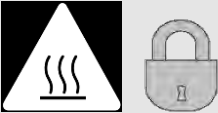
The following is only a guide, for more complex fault diagnoses please contact Norbar or a Norbar distributor.

Problem	Likely Reason	Likely Solutions
No Display	No mains power	Check electrical mains power is working
	External fuse or circuit breaker has operated	Check fuse or circuit breaker
	External RCD has operated	Check for faults then reset the RCD
Tool output does not rotate when trigger is pressed	Tool is on tight fastener	Remove from fastener Check correct setting of tool direction
	Tool is off	Ensure tool is ON (display lit)
	Tool is in set up mode	Exit set up to return to operate mode
	Output drive square sheared	See MAINTENANCE section to replace drive square
	Gear train or motor is damaged	Contact Norbar
Torque adjustment has no effect	Trigger is pressed	Release trigger
	In menu mode	Select exit
Red 'X' LED shown	Bolt has not made correct torque or angle	Trigger released early Fastener sheared or thread stripped
	Tool error	Contact Norbar
E21 or E16 (error codes)	Tool slammed into fastener. 230 V tool used on 110 V supply	Bring reaction bar slowly into position. Use correct mains voltage.
Measured angle is less than EvoTorque® applied	Flex in reaction bar or reaction point.	Ensure reaction bar & reaction point are rigid.
 "M=xx°C" Motor too hot.	Overuse at high torque	Rest tool until  is shown.
	Cooling fan blocked / broken.	Turn tool off. Unblock / fix fan.
 "D=xx°C" Display too hot.	Overuse at high torque	Rest tool until  is shown.
	Click sound from motor when not running.	Temperature measurement. Normal operation.
E>1000 N·m E>1350 N·m E>2000 N·m E>4000 N·m E>6000 N·m	Demand for torque greater than tool capacity.	Use larger capacity tool.
Display flashes	Cooling fan is blocked / broken	Turn tool off. Unblock / fix fan.

GLOSSARY OF TERMS

Word or Term	Meaning
A	Amps
a.c.	Alternating Current
A/F	Across Flats
Bi-directional	Clockwise and Counter Clockwise
ET	EvoTorque®
EvoTorque®	Product Name
Fastener	Bolt or stud to be tightened
Nose Extension	A reaction type used where tool access is restricted, a typical example is on wheel nuts on heavy vehicles
RCD	Residual Current Device, for disconnecting the electrical supply in the case of a fault; so protecting the operator. A device with a trip value of 30mA or less is recommended.
Torque Rate	The increase in torque with angular displacement while advancing a fastener in a threaded joint (as defined in ISO 5393 Rotary Tools for Threaded Fasteners – Performance Test Method.) A LOW torque rate is often referred to as a SOFT joint. A HIGH torque rate is often referred to as a HARD joint.
Reaction Bar	Item to counteract applied torque. Also called Reaction Plate
V	Volts

**NORBAR TORQUE TOOLS LTD**

Wildmere Road, Banbury,
Oxfordshire, OX16 3JU
UNITED KINGDOM
Tel + 44 (0)1295 270333
Email enquiry@norbar.com

**NORBAR TORQUE TOOLS PTE LTD**

194 Pandan Loop
#07-20 Pantech Business Hub
SINGAPORE 128383
Tel + 65 6841 1371
Email enquires@norbar.sg

**NORBAR TORQUE TOOLS**

45–47 Raglan Avenue, Edwardstown,
SA 5039
AUSTRALIA
Tel + 61 (0)8 8292 9777
Email enquiry@norbar.com.au

**NORBAR TORQUE TOOLS (SHANGHAI) LTD**

E Building–5F, no. 1618 Yishan Road,
Minhang District, Shanghai
CHINA 201103
Tel + 86 21 6145 0368
Email sales@norbar.com.cn

**NORBAR TORQUE TOOLS INC**

36400 Biltmore Place, Willoughby,
Ohio, 44094
USA
Tel + 1 866 667 2279
Email inquiry@norbar.us

**NORBAR TORQUE TOOLS INDIA PVT. LTD**

Plot No A-168, Khairne Industrial Area,
Thane Belapur Road, Mahape,
Navi Mumbai – 400 709
INDIA
Tel + 91 22 2778 8480
Email enquiry@norbar.in

www.norbar.com



www.norbar.com/HowToUseAnEvoTorque