

Operation instruction • english
Gebrauchsanweisung • deutsch
Gebruiksaanwijzing • nederlands
Manuel d'utilisation • français

1923412E
0612

PROMIG

530



CONTENTS

1. PREFACE	3
1.1. INTRODUCTION.....	3
1.2. PRODUCT INTRODUCTION.....	3
1.2.1. OPERATION CONTROL AND CONNECTORS.....	4
1.2.2. PARTS OF WIRE FEED MECHANISM.....	6
1.2.3. QUICK GUIDE FOR OPERATION OF MC PANEL.....	7
1.2.4. QUICK GUIDE FOR OPERATION OF ML PANEL.....	8
1.3. OPERATION SAFETY.....	10
2. INSTALLATION	11
2.1. ASSEMBLY OF MIG SYSTEM.....	11
2.2. ACCESSORIES CORRESPONDING TO WIRE DIAMETER.....	12
2.3. MOUNTING OF MIG WELDING GUN.....	12
2.4. MOUNTING AND LOCKING OF WIRE REEL.....	13
2.5. AUTOMATIC WIRE FEED TO GUN.....	13
2.6. ADJUSTMENT OF PRESSURE.....	14
2.7. ADJUSTMENT OF TIGHTNESS OF REEL BRAKE.....	14
2.8. BURN BACK TIME.....	14
2.9. GROUND CABLE.....	14
2.10. SHIELD GAS.....	15
2.10.1. INSTALLING GAS BOTTLE.....	15
2.11. MAIN SWITCH I/O.....	16
2.12. OPERATION OF COOLING UNIT (PROCOOL 10, PROCOOL 30).....	16
3. CONTROL PANELS OPERATIONS	16
3.1. MC CONTROL PANEL 6263501.....	16
3.1.1. WELD DATA / GAS TEST.....	19
3.1.2. SELECTO OPERATIONS, MC PANEL.....	19
3.2. ML CONTROL PANEL 6263502.....	20
3.2.1. WELD DATA.....	24
3.2.2. SYNERGIC OPERATIONS, ML PANEL.....	24
5. PROMIG 530 A001 JUMPER BLOCK FUNCTIONS	28
6. ERROR CODES OF PANELS	30
7. SERVICE, OPERATION DISTURBANCES	31
7.1. DISPOSAL OF THE MACHINE.....	31
8. ORDERING NUMBERS	32
9. TECHNICAL DATA	34
10. TERMS OF GUARANTEE	35

1. PREFACE

1.1. INTRODUCTION

Congratulations on having purchased this product. Properly installed Kemppi products should prove to be productive machines requiring maintenance at only regular intervals. This manual is arranged to give you a good understanding of the equipment and its safe operation. It also contains maintenance information and technical specifications. Read this manual from front to back before installing, operating or maintaining the equipment for the first time. For further information on Kemppi products please contact us or your nearest Kemppi distributor.

The specifications and designs presented in this manual are subject to change without prior notice.

In this document, for danger to life or injury the following symbol is used: 

Read the warning texts carefully and follow the instructions. Please also study the Operation safety instructions and respect them when installing, operating and servicing the machine.

1.2. PRODUCT INTRODUCTION

Promig 530 is wire feeder designed for demanding professional use.

Versatile and easy to use operation functions of PROMIG units have been realized with interchangeable control panels which point out different characteristics:

MC: basic controls and displays for MIG/MMA welding, Selecto memories

ML: basic controls and displays for MIG/MMA welding, Synergic MIG/PULSED MIG

MXE: versatile adjustments for synergic MIG/Pulsmig and MIG/MMA welding

Operations of wire feed unit are controlled and adjusted with microprocessor. Tacho generator of wire feed motor enables accurate and even adjustment of wire feed speed.

These operation instructions handle Promig 530 wire feed unit, assembly and installation of MIG system as well as operation functions of panels.



This equipment's electromagnetic compatibility (EMC) is designed for use in an industrial environment. Class A equipment is not intended for use in residential location where the electrical power is provided by the public low-voltage supply system.

1.2.1. Operation control and connectors

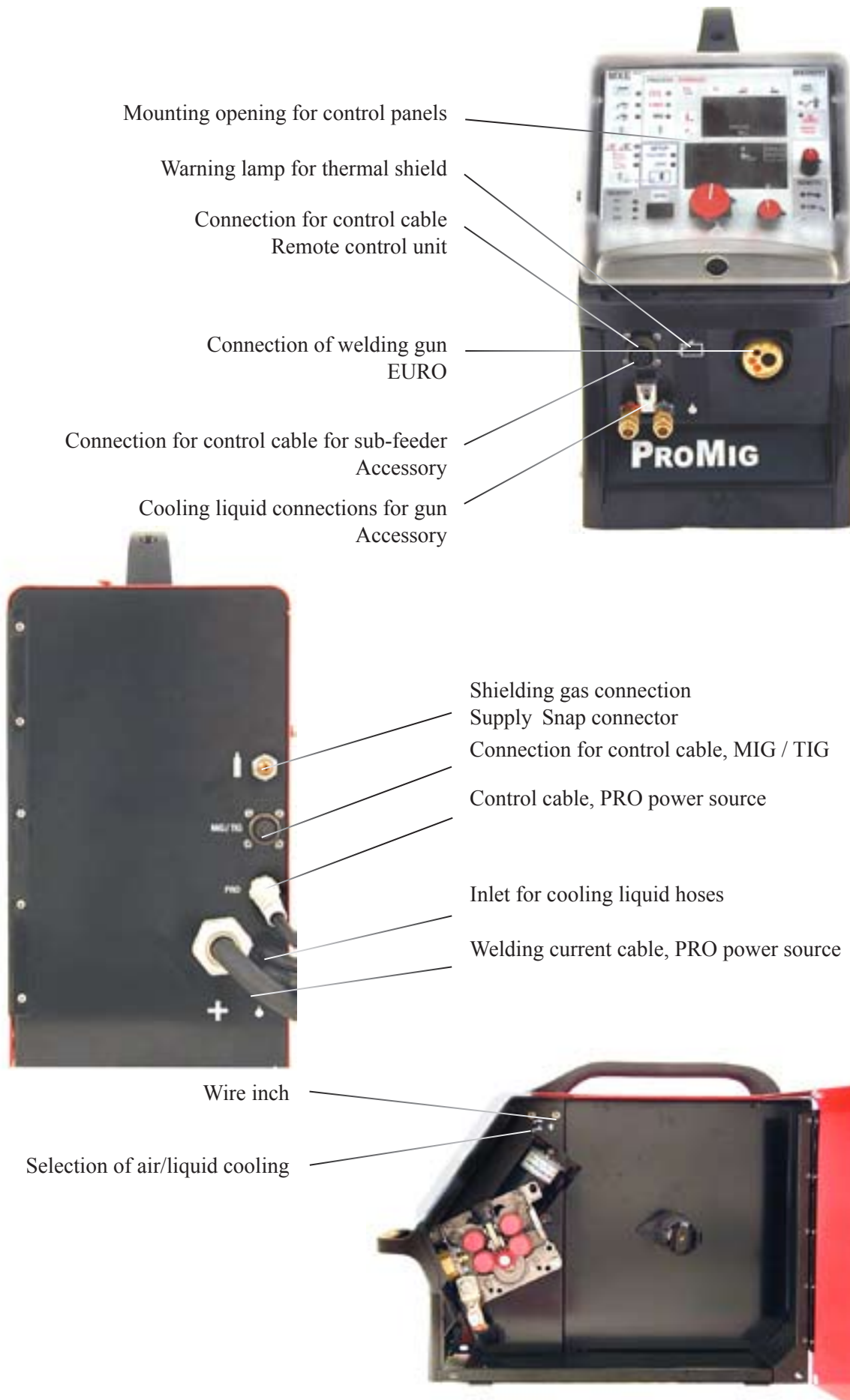

PROMIG 530

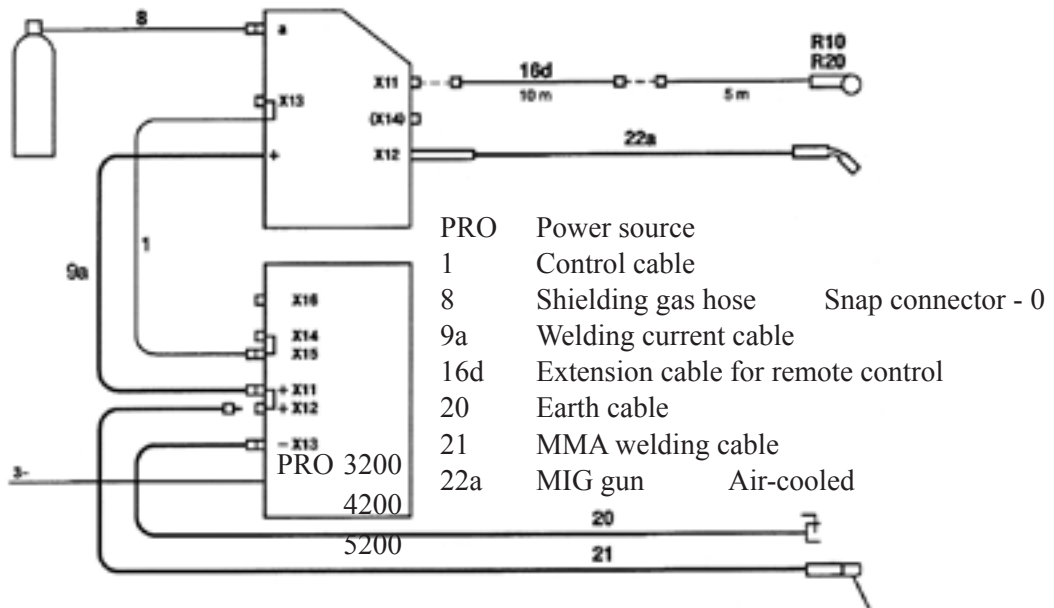

PROMIG 530

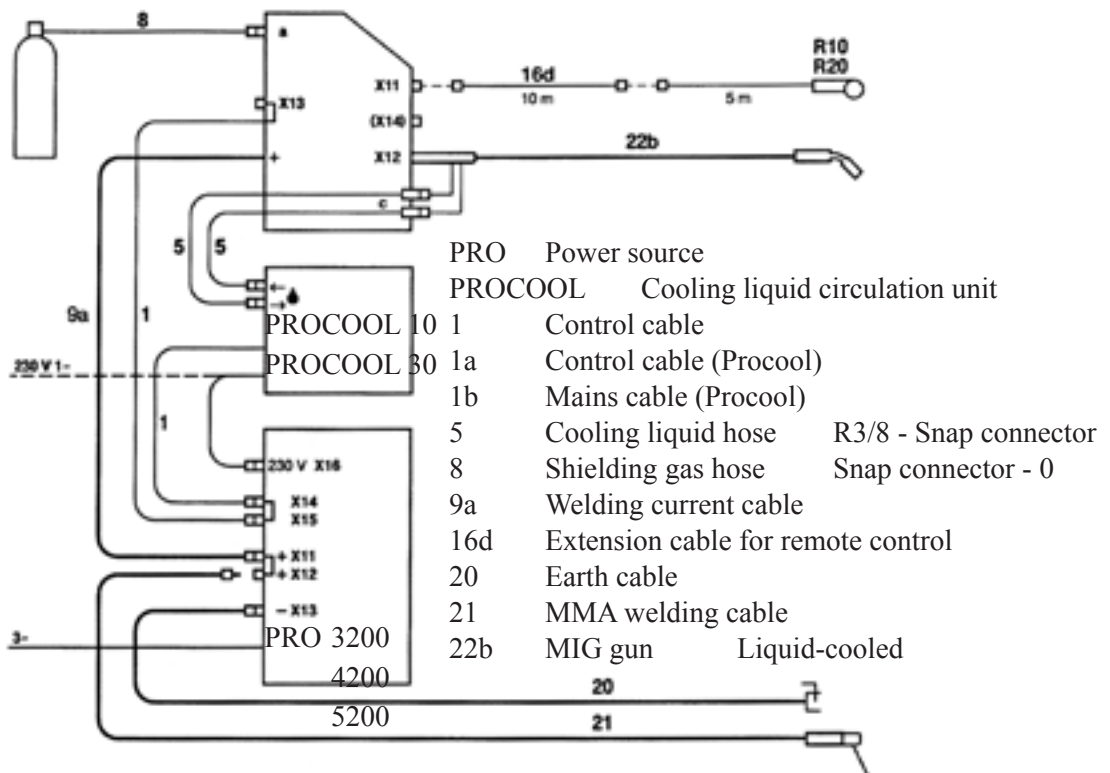

1.2.2. Parts of wire feed mechanism

Promig 530

Wire guide tubes									
Fe	ϕ 0,6...0,8 mm	ϕ 1,0 mm	3134140	ϕ 2,0 mm	3134120	ϕ 2,0 mm	4267220	ϕ 2,4 mm	4268210
		white	orange			plastic	yellow		
Mc	ϕ 0,9...1,6 mm	ϕ 2,0 mm	3133700	ϕ 4,0 mm	3134110	ϕ 2,0 mm	4266970	ϕ 4,0 mm	4270180
Fc		orange	blue			plastic	brass		
Ss	ϕ 1,6...2,4 mm	ϕ 4,0 mm	3134130	ϕ 2,5 mm	3134300	ϕ 2,0 mm	4267220	ϕ 3,0 mm	4268560
		blue	silver			plastic	yellow		
Al	ϕ 0,8...1,6 mm	ϕ 3,0 mm	3134710	ϕ 3,0 mm	3134720	ϕ 4,0 mm	4270180		
		yellow	yellow	yellow	yellow	plastic			

Promig 511

pressure adjustment

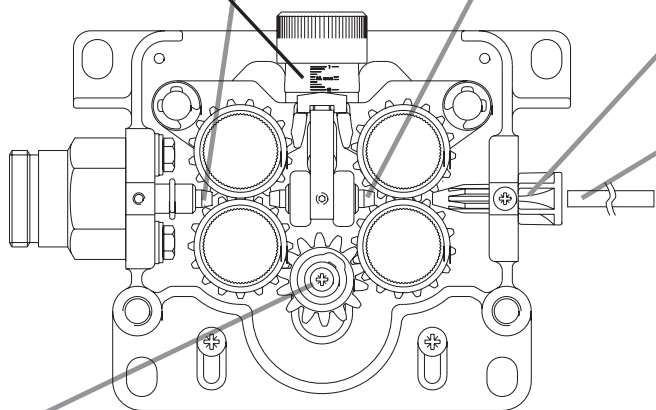

Syöttöpyörän uran valinta, val av matarhjulspår, valg av matehjul spor, valg af spor i trådhjul, selection of feed wheel groove, Auswahl der Transportrollennut, selectie van de draaddiameter groef, sélection de la gorge du galet

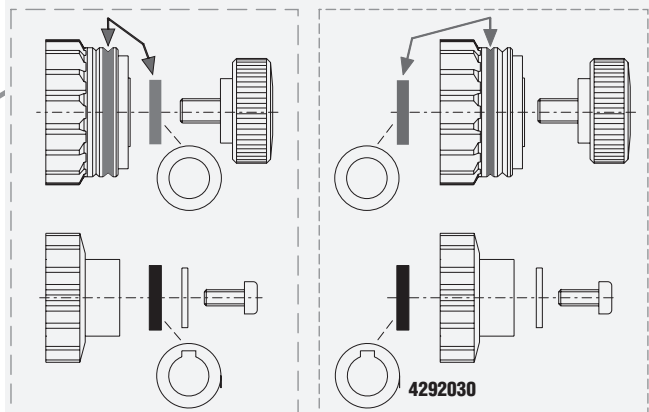

Vetoratas, drivhjul, trekkstannhjul, drivhjul, gearwheel, Aufziehrad, aandrijfrol, galet d'entrainement

ϕ 28 mm (0 - 18 m/min) 4265240, ϕ 40 mm (0 - 25 m/min) 4265250

Muovi, plast, plast, plastic, plastic, Kunststoff, plastic, plastique

ϕ 28 mm (0 - 18 m/min) 4287860, ϕ 40 mm (0 - 25 m/min) 4297270

Teräs, stål, stål, steel, Stahl, staal, acier

Vetorattaan valintalevyn siirto, flytning av distansbricka, flytting av avstandsskive for matehjul, hvordan flytter man justerskiven, relocation of selection plate, Versetzen der Wahlschalterplatte, verplaatsing van selectie plaat, remise en place de la rondelle de sélection

Feed rolls



Fe	Plain	ϕ 0,6/0,8	3133810	ϕ 1,0/1,2	3133210	ϕ 1,4-1,6/2,0	3133820	ϕ 2,4	3133880
		ϕ 0,8/0,8 (L)	3143180	ϕ 1,0/1,0 (L)	3138650	ϕ 1,6/1,6 (L)	3141120	black	
Ss		white		red		yellow		ϕ 3,2	3133910
Al				orange	ϕ 1,2/1,2 (L)	3137390		blue	
Fe	Knurled			red	ϕ 1,0/1,2	3133940	ϕ 1,4-1,6/2,0	ϕ 2,4	3134030
Fc				orange	ϕ 1,2/1,2 (L)	3137380	ϕ 1,6/1,6 (L)	3141130	black
Mc								blue	3134060
Fe	Trapezoid			orange	ϕ 1,2/1,2 (L)	3142210	ϕ 1,4/1,4 (L)	ϕ 2,0/2,0 (L)	3142230
Fc							brown	grey	
Mc								ϕ 2,4 (L)	3142240
Ss								black	
Al									

(L) = Ball race

W000574

1.2.3. Quick guide for operation of MC panel

MIG welding with independent adjustments for wire feed and voltage

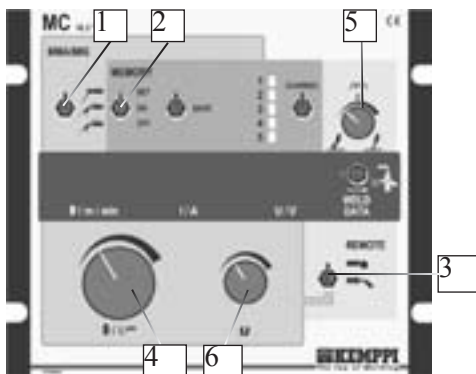

1. Select with selecting switch for method MIG two sequence procedure or MIG four-sequence procedure
2. Select with SELECTO mode switch the position OFF
3. Select the control mode: local control, remote control or gun control
4. Adjust required set values for wire feed speed and voltage. Values are shown in displays
5. Set welding dynamics at zero position or at required position
6. Weld and adjust wire feed speed and voltage when needed

MIG welding with welding values stored in SELECTO memories

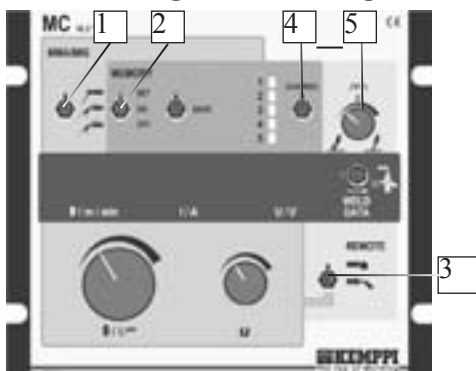

1. Select with selecting switch for method MIG two-sequence procedure or MIG four-sequence procedure
2. Select with SELECTO mode switch the position ON
3. Select the channel selection mode: local control, remote control or gun control
4. Select required channel 1...5. Welding values stored on channel are shown in displays
5. Weld and select another channel when needed. You can change the channel also during welding

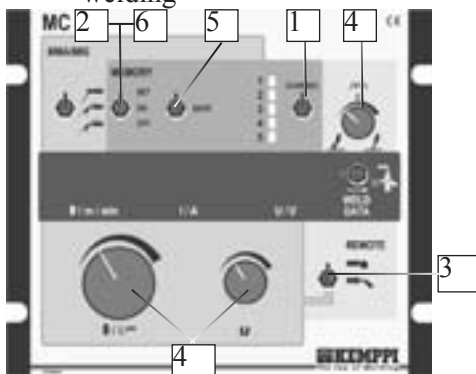

Programming of SELECTO memories

1. Select required channel 1...5
2. Select with SELECTO mode switch the position SET
3. Select the control mode: local control, remote control or gun control
4. Search by welding correct values for wire feed speed, voltage and welding dynamics

5. Store them into memory by turning the SAVE switch. Note! When necessary you can check the values stored on the memory channel by turning the SELECTO mode switch on position ON, then the displays show values which are in memory of the channel in question.
6. Turn the SELECTO mode switch on position ON, then channels are ready for welding. Note! You cannot store into memory MMA welding values and MIG two-sequence/four-sequence selection

MMA welding

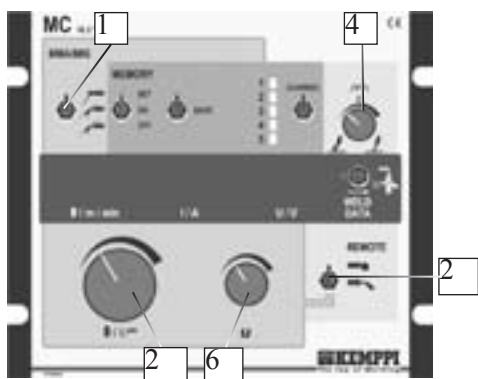

1. Select MMA welding with selecting switch for method
2. Select the control mode: local control, remote control or gun control
3. Adjust required MMA current. Values are shown in displays
4. Set welding dynamics on position zero or on required position
5. Weld and adjust MMA current when needed

1.2.4. Quick guide for operation of ML panel

MIG welding with independent adjustments for wire feed and voltage

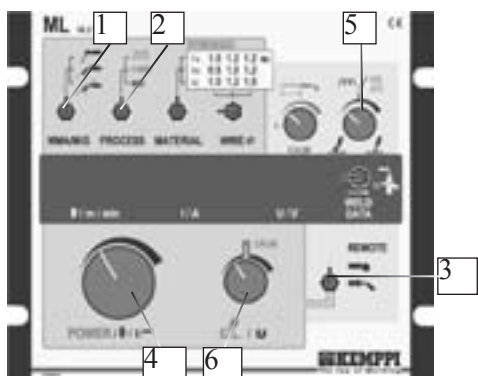

1. Select with selecting switch for method MIG two-sequence procedure or MIG four-sequence procedure
2. Select with SYNERGIC mode switch the position MIG
3. Select the control mode: local control, remote control or gun control
4. Adjust required set values for wire feed speed and voltage. Values are shown in displays
5. Set welding dynamics at zero position or at required position
6. Weld and adjust wire feed speed and voltage when needed

SYNERGIC MIG welding

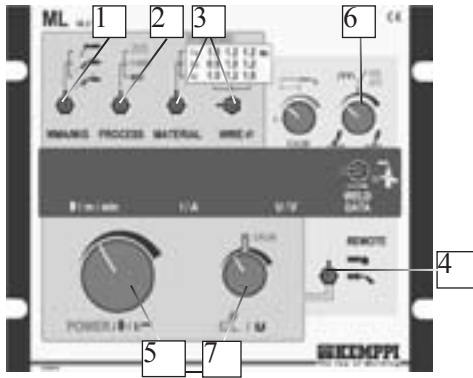

1. Select with selecting switch for method MIG two-sequence procedure or MIG four-sequence procedure
2. Select with SYNERGIC mode switch the position 1-MIG
3. Set selecting switches for material and diameter corresponding to filler wire used by you
4. Select the control mode: local control, remote control or gun control
5. Adjust the required power with the potentiometer and the arc length with the potentiometer. Values are shown in displays
6. Set welding dynamics on zero or required position
7. Weld and adjust welding power and arc length when needed.

SYNERGIC PULSED MIG welding

1. Select with selecting switch for method MIG two-sequence procedure or MIG four-sequence procedure

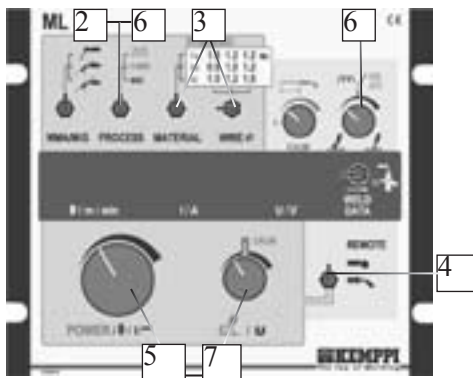

2. Select with SYNERGIC mode switch the position
3. Set selecting switches for material and diameter corresponding to filler wire used by you
4. Select the control mode: local control, remote control or gun control
5. Adjust the required power with the -potentiometer and the arc length with the potentiometer. Values are shown in displays
6. Set welding dynamics on zero or required position
7. Weld and adjust welding power and arc length when needed.

MMA welding

1. Select MMA welding with selecting switch for method
2. Select the control mode: local control, remote control or gun control
3. Adjust required MMA current. Values are shown in displays
4. Set welding dynamics on position zero or on required position
5. Weld and adjust MMA current when needed

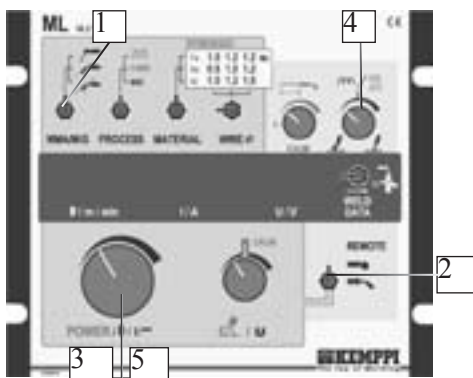

1.3. OPERATION SAFETY

Please study these Operation safety instructions and respect them when installing, operating and servicing the machine.

Welding arc and spatters

Welding arc hurts unprotected eyes. Be careful also with reflecting arc flash. Welding arc and spatter burn unprotected skin. Use safety gloves and protective clothing.

Danger for fire or explosion

Pay attention to fire safety regulations. Remove flammable or explosive materials from welding place. Always reserve sufficient fire-fighting equipment on welding place. Be prepared for hazards in special welding jobs, eg. for the danger of fire or explosion when welding container type work pieces. Note! Fire can break out from sparks even several hours after the welding work has been finished!

Mains voltage

Never take welding machine inside a work piece (eg. container or truck). Do not place welding machine on a wet surface. Always check cables before operating the machine. Change defect cables without delay. Defect cables may cause an injury or set out a fire. Connection cable must not be compressed, it must not touch sharp edges or hot work pieces.

Welding power circuit

Isolate yourself by using proper protective clothing, do not wear wet clothing. Never work on a wet surface or use defect cables. Do not put MIG-gun or welding cables on welding machine or on other electric equipment. Do not press MIG-gun switch, if the gun is not directed towards a work piece.

Welding fumes

Take care that there is sufficient ventilation during welding. Take special safety precautions when welding metals which contain lead, cadmium, zinc, mercury or beryllium.

2. INSTALLATION

2.1. ASSEMBLY OF MIG SYSTEM

Assemble the units in below-mentioned order and follow mounting and operation instructions which are delivered in packages.

1. Installation of power source

Read paragraph: "Installation" in operation instructions 1913170 for Kemppi Pro Evolution power sources and carry out the installation according to that.

2. Mounting of PRO power source to transport wagon

P40 6185261, air-cooled MIG system mounting / assembly instructions 4270450

P30W 6185262, liquid-cooled MIG system mounting / assembly instructions 4270460

3. Put the PROMIG onto the power source and lock it with bolts to handles of power source

4. Mounting of PROMIG control panel

MC 6263501, mounting instructions 4270950

ML 6263502, mounting instructions 4270950

5. Connecting cables

Connect cables according to figures on pages 6...7.

Air-cooled system on page 6. Liquid-cooled system on page 7.

You can change polarity of filler wire by interchanging the PROMIG welding current cable and earth cable with welding cable connectors of PRO power source.

6. Max. wire feed speed

When the unit is delivered the max. wire feed speed is 18 m/min, which is enough for most welding works. If you need a higher speed, you can increase the max. wire feed speed to 25 m/min by replacing the gear wheel on motor shaft to a bigger one. The big gear wheel D40 is delivered with the feed unit in accessory drawer.

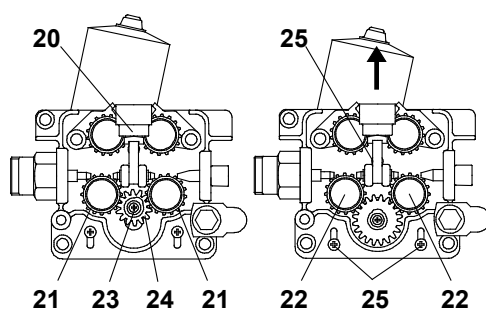
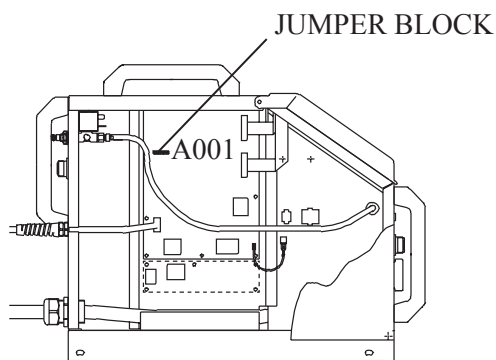
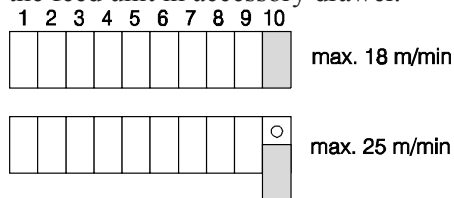

When necessary speed is changed according to following:

- Open side plate and move JUMPER BLOCK's 10th coding piece on control card A001 to point 25 m/min.
- Open tightening lever (20). Remove lower feed rolls (21). Release screw (23) and its washer. Remove gear wheel D28 (24) from motor shaft.
- Loosen screws (25) (3 pc) 1 twist. Mount the D40 gear wheel onto motor shaft. Screw the screw (23) with its washer back.
- Put feed rolls (21) back to their axles, however don't fasten yet fastening screws of feed rolls (22).
- Lift the motor so that the tooth gap between gear wheel and both lower feed rolls is approx. 0,2 mm.
- Tighten screws (25). Check gear teeth gaps, when necessary put the motor into a better position. Screw on the mounting screws of feed rolls (22).



Too small gap between gear wheel and feed rolls will overload motor. Too big gap for its part might cause too rapid wearing for teeth of feed rolls and gear wheel.

7. Mounting of Promig 530 to boom



Wire feed unit must be mounted to boom in such a way that its chassis is galvanic separated both from swing arm and boom.

Suspension angle of wire feed unit can be changed by moving fixing point in handle.

2.2. ACCESSORIES CORRESPONDING TO WIRE DIAMETER

PROMIG wire feed rolls are available with plain groove, knurled groove and with U groove for different purposes.

Feed rolls with plain groove: Universal feed roll for welding of all kinds of wires.

Feed rolls with knurled groove: Special feed roll for cored wires and steel wires.

Feed rolls with U groove: Special feed roll for aluminium wires.

Trapezoid slotted, pivoted feed wheels: For heavy welding

PROMIG wire feed rolls have two grooves for different filler wire diameters. Correct wire groove is selected by moving selecting washer (28) from one side to another in feed roll.

Feed rolls and wire guide tubes of wire feed unit have colour codes in order to make identification easier (see table on page 8).

Feed rolls		
colour	filler wire \varnothing mm	inch
white	0.6 and 0.8	0.030
red	0.9/1.0 and 1.2	0.035, 0.045 and 0.052
yellow	1.4, 1.6 and 2.0	1/16 and 5/64
black	2.4	3/32
Guide tubes		
colour	filler wire \varnothing mm	inch
orange	0.6-1.6	0.024-1/16
blue	over 1.6	over 1/16

In delivery Promig 530 are equipped with red feed rolls with plain groove and with orange wire guide tubes for welding filler wires of 0.9-1.2 mm (0.035", 0.045" and 0.052").

2.3. MOUNTING OF MIG WELDING GUN

In order to ensure trouble-free welding check in operation instructions of gun used by you that wire guide tube and contact tip of gun are according to manufacturer's recommendation suitable to be used for wire feed diameter and type in question. Too tight a wire guide tube might cause for wire feed unit a bigger stress than normally as well as disturbances in wire feed.

Screw snap connector of gun tight that there won't come any voltage losses on connecting surface.

A loose connection will heat gun and wire feed unit.

When you are using liquid-cooled gun, mount water hoses according to figure on page 7.

Error signal lamp H11 of Promig 530 unit have operations for overheating of liquid-cooled PMT or WS gun and for overload of wire feed motor. Operation of signal lamp is as follows (also see error codes on page 23):

1. Thermal release of the KEMPPI PMT or WS gun is operating. Then the equipment stops the welding, yellow signal lamp H11 starts to blink and at the same time on (wire feed) display of panel appears the text Err 8.
2. The wire feed motor is slightly overloaded e.g. due to a blocked gun. Then the error signal lamp H11 starts to blink. If overload of motor is big, welding is stopped and on (wire feed) display of panel appears the text Err 9.

Blinking of the H11 signal lamp followed by the error codes Err 8 and Err 9 is stopped by the following start, if the reason of the error code has been abolished or if the gun has cooled down or the motor is no more overloaded.

2.4. MOUNTING AND LOCKING OF WIRE REEL

- Release locking nails of wire reel hub by turning locking knob a quarter round.
- Mount the reel at its place. Note rotating direction of reel!
- Lock the reel with locking knob, locking nails of hub remain to outside position and will lock the reel.

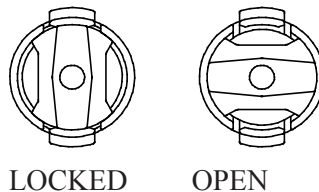

⚠ Check that in filler wire reel there are no parts sticking out, which could e.g. chafe against chassis or door of wire feed unit. Dragging parts might expose chassis of wire feed unit under voltage.

2.5. AUTOMATIC WIRE FEED TO GUN

Automatic wire feed in PROMIG wire feed units makes change of wire reel more rapid. In reel change the pressure of feed rolls need not to be released and filler wire goes automatically to correct wire line.

- Make sure that groove of feed roll match the diameter of welding wire used. Feed roll groove is selected by moving the groove selecting washer (28).

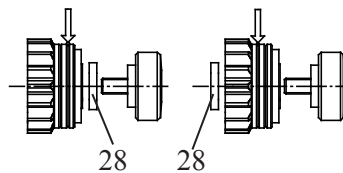

- Release the wire end from reel and cut off the bent length. Be careful that the wire does not spill from the reel to sides!
- Straighten about 20 cm of the wire and see that the end of it has no sharp edges (file off if necessary). A sharp edge may damage the wire guide tube and contact tip of the welding gun.

Promig 530:

- Draw a bit of loose wire from wire reel. Feed wire through back liner to feed rolls. Do not release pressure of feed rolls!
- Press the gun switch and feed a bit wire until wire goes through feed rolls to gun. See that wire is in grooves of both feed roll pairs!
- Press still the gun switch until wire has come through contact tip.

Automatic feed may sometimes fail with thin wires (Fe, Fc, Ss: 0,6...0,8 mm, Al: 0,8...1,0 mm). In that case you might have to open feed rolls and feed wire manually through feed rolls.

2.6. ADJUSTMENT OF PRESSURE

Adjust the pressure of feed rolls with the control screw (20) so that the wire is fed into the wire guide tube evenly and allows a little braking when coming out from the contact tip without slipping at the feed rolls.



Excessive pressure causes flattening of the filler wire and damage to the coating. It also causes undue wear of the feed rolls as well as friction.

2.7. ADJUSTMENT OF TIGHTNESS OF REEL BRAKE

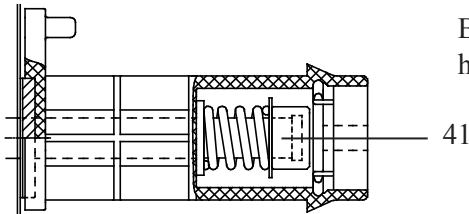

Brake force is adjusted through hole in locking device of reel hub by screwing the control screw (41) with screwdriver.

Adjust brake force as so big that the wire is not allowed to become too loose on the reel so that it would spill from the reel when the rotation of the reel stops. Need for brake force is increased with increase of wire feed speed.

Since the brake loads for its part the motor, you shouldn't keep it unnecessarily tight.

2.8. BURN BACK TIME

Electronics of feed unit controls stopping of welding automatically so that the wire end doesn't melt fastened to the contact tip or the work piece. Automatics work regardless of the wire feed speed.

2.9. GROUND CABLE

Fasten earthing press of ground cable carefully, preferably direct to welding piece. Contact surface of press always should be as large as possible.

Clean the fastening surface from paint and rust!

Use in your MIG equipment at least 70 mm². Thinner cross-sectional areas might cause overheating of connectors and insulations.

Make sure that the welding gun in your use is designed for max. welding current needed by you!
Never use a damaged welding gun!

2.10. SHIELD GAS

⚠ Handle gas bottle with care. There is a risk for injury if gas bottle or bottle valve is damaged!

For welding stainless steels, mixed gases are normally used. Check that the gas bottle valve is suitable for the gas. The flow rate is set according to the welding power used in the job. A suitable flow rate is normally 8 - 10 l/min. If the gas flow is not suitable, the welded joint will be sporous. Contact your local Kemppi-dealer for choosing gas and equipment.

2.10.1. Installing gas bottle

⚠ Always fasten gas bottle properly in vertical position in a special holder on the wall or on a carriage. ReSAVEber to close gas bottle valve after having finished welding.

Parts of gas flow regulator

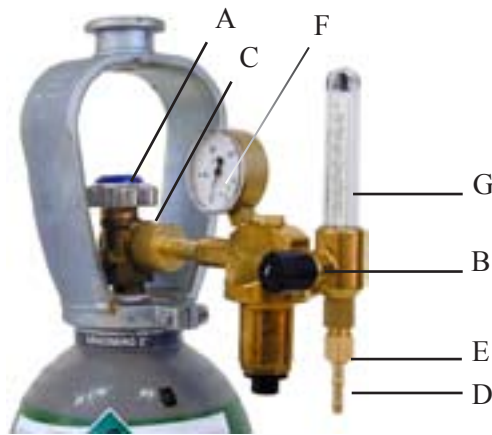

- A Gas bottle valve
- B Press regulation screw
- C Connecting nut
- D Hose spindle
- E Jacket nut
- F Gas bottle pressure meter
- G Gas hose pressure meter

The following installing instructions are valid for most of the gas flow regulator types:

1. Step aside and open the bottle valve (A) for a while to blow out possible impurities from the bottle valve.
2. Turn the press regulation screw (B) of the regulator until no spring pressure can be felt.
3. Close needle valve, if there is one in the regulator.
4. Install the regulator on bottle valve and tighten connecting nut (C) with a wrench.
5. Install hose spindle (D) and jacket nut (E) into gas hose and tighten with hose clamp.
6. Connect the hose with the regulator and the other end with the wire feed unit. Tighten the jacket nut.
7. Open bottle valve slowly. Gas bottle pressure meter (F) shows the bottle pressure. Note! Do not use the whole contents of the bottle. The bottle should be filled when the bottle pressure is 2 bar.
8. Open needle valve if there is one in the regulator.
9. Turn regulation screw (B) until hose pressure meter (G) shows the required flow (or pressure).
When regulating flow amount, the power source should be in switched on and the gun switch pressed simultaneously.

Close bottle valve after having finished welding. If the machine will be out of use for a long time, unscrew the pressure regulation screw.

2.11. MAIN SWITCH I/O

When you turn the main switch of the Kemppi Pro Evolution power source into I-position, pilot lamp close to it is lighted and the equipment is ready for welding. The equipment is returned to that welding method with which the welding was last carried out before the main switch was turned to zero position.



Always start and switch off the machine with the main switch, never use the mains plug as a switch.

2.12. OPERATION OF COOLING UNIT (PROCOOL 10, PROCOOL 30)

Operation of cooling unit is controlled in such a way that pump is started when welding is started. After welding stop pump is rotating for approx. 5 min cooling the liquid to ambient temperature. Read in operation instructions for the PROCOOL 10 / 30 unit the trouble situations of the liquid circulation system and protection against torch etc. damage.

3. CONTROL PANELS OPERATIONS

3.1. MC CONTROL PANEL 6263501

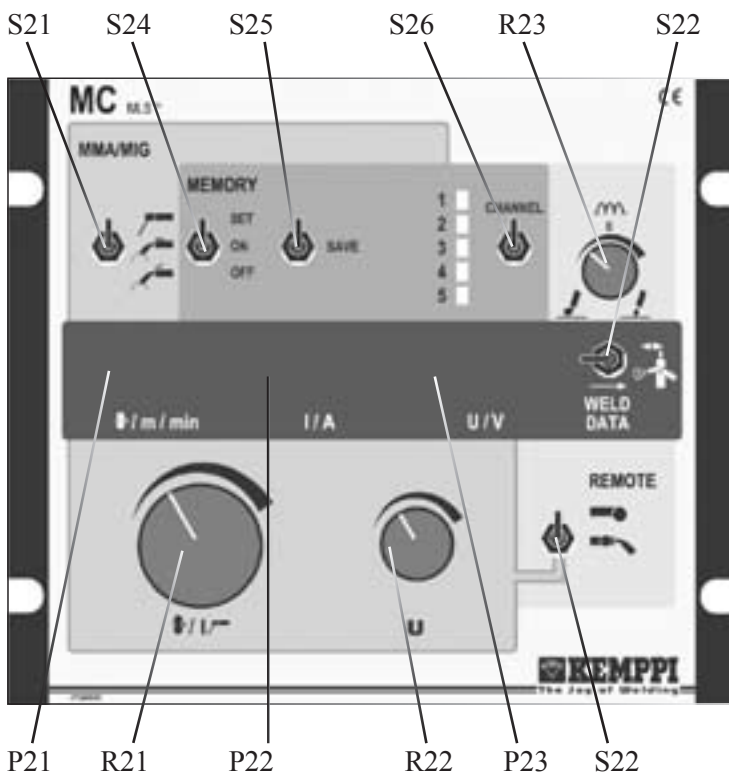

MIG basic operations

Welding method selection (S21): MIG two-sequence procedure, MIG four-sequence procedure, MMA

Control mode selection (S22): local, remote, gun

Local controls: wire feed speed/MMA current (R21), welding voltage (R22)

Controls for MIG and MMA welding dynamics (R23)

Digital displays: wire feed speed (P21), current (P22), voltage (P23)

Retrieval of last used welding values (S23)

SELECTO operations

SELECTO mode switch S24

OFF: Normal MIG/MAG welding

ON: Welding with memory stored values (5 channels)

SET: Welding parameters selection and storage SAVE (S25), for selected channel CH 1...5 (S26).

Welding method selecting switch S21

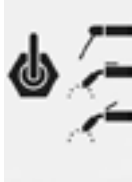

MMA: MMA welding with stepless welding current control

MIG two-sequence procedure

MIG/MAG welding with two-sequence procedure of welding gun start switch

1. switch pressed: welding starts

2. switch open: welding stops

MIG four-sequence procedure

MIG/MAG welding with four-sequence procedure of welding gun start switch

1. switch pressed: shielding gas flow starts

2. switch open: welding starts

3. switch pressed: welding stops

4. switch open: shielding gas flow stops

Control mode selecting switch S22

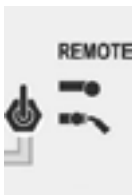

Local control:

Control potentiometers R21 and R22 on panel are used.

Remote control:

Adjustments are carried out from remote control unit R20 which is connected to remote control connector X11 of wire feed unit.

If you use the remote control unit R10, adjust wire feed speed or MMA welding current with potentiometer of the R10 and voltage with potentiometer U on panel.

Gun control:

Wire feed speed is adjusted with control module RMT 10 which is connected to KEMPPI PMT or WS welding gun and welding voltage is adjusted with potentiometer.

Note! If the remote control unit or the gun control unit is not connected to the PROMIG and you have selected remote control or gun control, then controls operate with local control potentiometers like in local control position.

Local controls R21, R22



 potentiometer

SELECTO OFF: Local control for wire feed speed 0...18 m/min or 0...25 m/min

SELECTO ON: No operation

SELECTO SET: Local control for wire feed speed 0...18 m/min or 0...25 m/min

MMA welding: Welding current control, 10 A...max. current of power source

 potentiometer

SELECTO OFF: local control for voltage of PRO power source, 10 V...max. MIG voltage of power source

SELECTO ON: No operation

SELECTO SET: local control for voltage of PRO power source, 10 V...max. MIG voltage of power source

MMA welding: No operation

Control of welding dynamics R23



MIG and MMA welding dynamics are adjusted with the same potentiometer. When you adjust welding dynamics the adjustment value -9...0...9 is shown in display V, which otherwise shows set value/welding voltage. Value of dynamics is shown in display still for approx. 3 s after stopping the adjustments.

Control of MIG welding dynamics:

With control of MIG welding dynamics you can influence on how stable the arc is and how much spatter there is. With this control you can also optimize the welding result for wire type and shielding gas mixture you are using.

-9...-1 Softer arc. Object: minimizing spatter

0 Recommendable basic setting for all wires

1...9 Harder arc. Object: e.g. maximizing stability of the arc on short circuit and welding of steel with 100 % CO₂ shielding gas (settings 7...9).

Control of MMA dynamics:

With control of MMA dynamics you can influence on arc in different situations.

When you make the arc harder, blow and at the same time spatter is increased.

-9...-1 Softer arc. Object: Minimizing spatter in welding at upper end of recommended currents for electrode.

0 Factory setup. Normal setting for all electrode types.

1...9 Harder arc. Object: e.g. cellulose covered electrodes (9) and thin stainless electrodes in welding at lowerend of recommended currents for electrode.

Digital display for wire feed speed, current and voltage P21, P22, P23



m/min display

MIG welding:

Display shows set value for wire feed speed and true value 0.0...18.0 m/min or 0.0...25.0 m/min during welding depending on selection of wire feed speed range.

MMA welding:

Display is blank at MMA welding.

A display

MIG welding:

Display shows in setting state 0 A and true value for welding current during welding.

MMA welding:

Display shows set value for MMA welding current 10 A ...max. current of power source and true value during welding.

V display

MIG welding:

Display shows set value for welding voltage and true value during welding.

MMA welding:

Display shows in setting state open circuit voltage of power source and true value during welding for MMA welding voltage.

Note! Display shows terminal voltage of power source. Depending on length and copper cross-section of welding cables as well as on that of MIG guns real arc voltage and display might differ many volts from each other, see table below.

Cable	50 mm ²	70 mm ²	95 mm ²
Voltage loss / 10 m	0,35 V / 100 A	0,25 V / 100 A	0,18 V / 100 A

When you adjust welding dynamics, display shows adjustment value for welding dynamics -9...0...9 and value is kept on display still for approx. 3 s after end of adjustment. After that display returns to show voltage.

3.1.1. WELD DATA / GAS TEST

Retrieval of welding parameters to displays,



Use of WELD DATA switch retrieves to displays welding parameters, wire feed speed, welding current, welding voltage which were used when welding was stopped last. Welding values are indicated in display for so long as you are using the WELD DATA switch and are kept in memory until you press again the start switch for gun.

Testing the gas flow

A short press on the switch starts the flow of the shielding gas. The shielding gas flows for approximately 20 seconds, or until the switch is pressed again.

3.1.2. SELECTO operations, MC panel



SELECTO is the name for the operation in which you can store welding parameters for memory channels for reutilization. You can store to memory five sets of MIG/MAG welding values. Parameters which can be stored are wire feed speed, welding voltage and welding dynamics. Stored values are kept in memory though power is switched off from unit.

Note! You cannot store MMA welding values and MIG 2-sequence/4-sequence selection.

In SELECTO operations are three different operating modes:

SELECTO OFF:

Normal MIG/MAG welding with independent adjustments for wire feed speed and voltage, SELECTO functions are not in use.

SELECTO ON:

Welding with stored welding values, wire feed speed, welding voltage and welding dynamics. Only channel selection, channels 1...5 from panel is operating. Channel is selected, depending on position of control mode, either with CH switch on panel, remote control unit or with regulating module RMT 10 of PMT or WS gun. You can change the channel also during welding.

Digital displays indicate values for wire feed speed and voltage which are stored on the channel in question. Stored value for welding dynamics can be brought to display by turning a little the adjustment potentiometer for welding dynamics.

SELECTO SET:

Search of welding data for storage. Welding data are stored for wished channel by using the SAVE switch. Those values for wire feed speed, voltage and welding dynamics are stored, which were set before using the SAVE switch.

Programming of memory channel:

1. Select channel 1...5
2. Set SELECTO mode switch on position SET.
3. Find by welding correct values for wire feed speed, voltage and welding dynamics.
4. Store them by using the SAVE switch.

Note! If you want you can check data which you have stored on memory channel by setting SELECTO mode switch on position ON, when displays show values which are in memory of the channel in question.

5. Set SELECTO mode switch on position ON and channels are in welding use.

From SELECTO operations go to normal MIG/MAG welding by setting the SELECTO mode switch on position OFF.

3.2. ML CONTROL PANEL 6263502

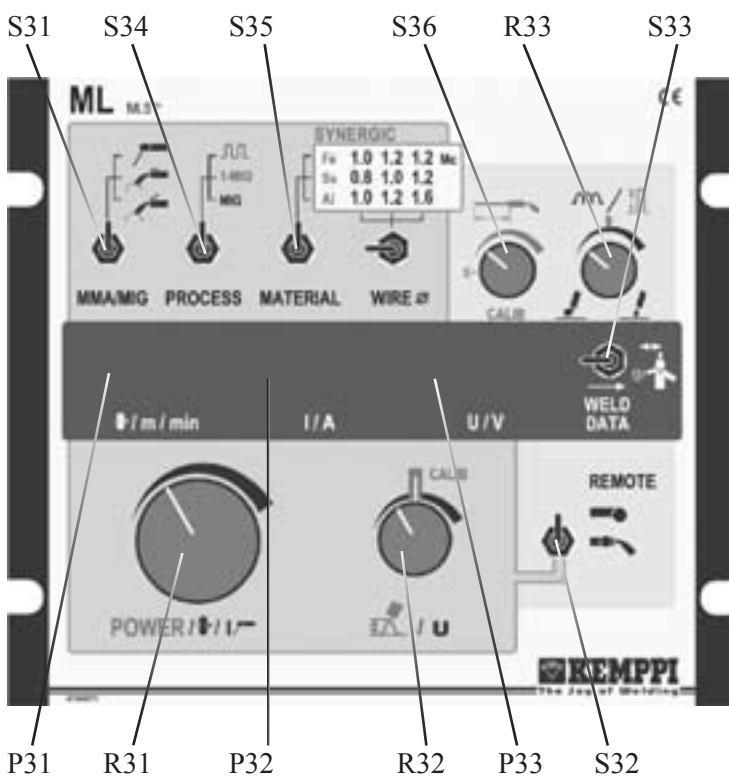

MIG basic operations

Welding method selection (S31): MIG two-sequence procedure, MIG four-sequence procedure, MMA

Control mode selection (S32): local, remote, gun

Local controls: wire feed speed/welding power/MMA current (R31), welding voltage (R32)

Controls for MIG and MMA welding dynamics (R33)

Digital displays: wire feed speed (P31), current (P32), voltage (P33)

Retrieval of last used welding values (S33)

SYNERGIC operations

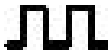
MIG	SYNERGIC mode switch S34 Normal MIG/MAG welding with independent adjustments for wire feed speed (R31) and voltage (R32).
1-MIG	SYNERGIC MIG, MIG welding with parameters which are optimized according to filler wires (S35, S36). Welding parameters are adjusted with adjustment potentiometers for welding power (R31) and arc length (R32).
	SYNERGIC PULSMIG, pulsed MIG welding with parameters which are optimized according to filler wires (S35, S36). Welding parameters are adjusted with adjustment potentiometers for welding power (R31) and arc length (R32). Compensating cable length (R34)

Welding method selecting switch S31

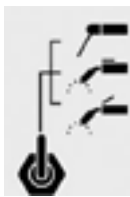

MMA

MMA welding with stepless welding current control

MIG two-sequence procedure

MIG welding with two-sequence procedure of welding gun start switch

1. switch pressed: welding starts

2. switch open: welding stops

MIG four-sequence procedure

MIG welding with four-sequence procedure of welding gun start switch

1. switch pressed: shielding gas flow starts

2. switch open: welding starts

3. switch pressed: welding stops

4. switch open: shielding gas flow stops

Control mode selecting switch S32



Local control:

Control potentiometers R31 and R32 on panel are used

Remote control:

Adjustments are carried out from remote control unit R20 which is connected to remote control connector X11 of wire feed unit. If you use the remote control unit R10, adjust wire feed speed/welding power or MMA welding current with potentiometer of the R10 and voltage/arc length with potentiometer U on panel.

Gun control:

Wire feed speed/welding power is adjusted with control module RMT 10 which is connected to KEMPPI PMT or WS welding gun and welding voltage/arc length is adjusted with potentiometer U on panel.

Note! If the remote control unit or the gun control unit is not connected to the PROMIG and you have selected remote control or gun control, then controls operate with local control potentiometers like in local control positions.

Local controls R31, R32



 potentiometer
MIG/MAG: Local control for wire feed speed 0...18 m/min or 0...25 m/min
SYNERGIC MIG: Power control, min. and max. powers according to filler wires
SYNERGIC PULSED MIG: Power control, min. and max. powers according to filler wires
MMA welding: Welding current control, 10 A...max. current of power source

 potentiometer
MIG/MAG: local control for voltage of PRO power source, 10 V...max. MIG voltage of power source
SYNERGIC MIG: Fine control for arc length -9...0...9
SYNERGIC PULSED MIG: Fine control for arc length -9...0...9
MMA welding: No operation



Control of welding dynamics R33

MIG and MMA welding dynamics are adjusted with the same potentiometer. When you adjust welding dynamics the adjustment value -9...0...9 is shown in display V, which otherwise shows set value/welding voltage. Value of dynamics is shown in display still for approx. 3 s after stopping the adjustments.

Control of MIG/MAG welding dynamics:

With control of MIG/MAG welding dynamics you can influence on how stable the arc is and how much spatter there is. With this control you can also optimize the welding result for wire type and shielding gas mixture you are using.

- 9...-1 Softer arc. Object: minimizing spatter
- 0 Recommendable basic setting for all wires
- 1...9 Harder arc. Object: e.g. maximizing stability of the arc on short circuit and welding of steel with 100 % CO₂ shielding gas (settings 7...9).

Control of SYNERGIC MIG welding dynamics:

In SYNERGIC MIG the control of welding dynamics is optimized for wire type you are using. With this control you can influence on stability of arc and how much spatter there is.

- 9...-1 Softer arc. Object: Minimizing spatter
- 0 Recommendable basic setting
- 1...9 Harder arc. Object: e.g. maximizing stability of the arc on short circuit

NOTE! Control range for MIG welding dynamics -9...0...9 is a relative range according to wire and is different from control range -9...0...9 for dynamics of normal MIG/MAG welding.

Shape of arc in SYNERGIC PULSMIG:

In SYNERGIC PULSMIG the control for welding dynamics has an influence on shape of pulsed MIG arc.

- 9...-1 Wider pulsed MIG arc. Object: e.g. welding of square butt preparation
- 0 Recommendable basic setting
- 1...9 More narrow and better directed arc. Object: e.g. fillet weld seams of thin basic materials

Control of MMA dynamics:

With control of MMA dynamics you can influence on arc in different situations.

When you make the arc harder, blow and at the same time spatter is increased.

- 9...-1 Softer arc. Object: Minimizing spatter in welding at upper end of recommended currents for electrode.
- 0 Factory setup. Normal setting for all electrode types.
- 1...9 Harder arc. Object: e.g. cellulose covered electrodes (9) and thin stainless electrodes in welding at lower end of recommended currents for electrode.

Digital display for wire feed speed, current and voltage P31, P32, P33



v/m/min display

MIG/MAG with independent controls for wire feed speed and voltage: Display shows set value for wire feed speed and true value 0.0...18.0 m/min or 0.0...25.0 m/min during welding depending on selection of wire feed speed range.

SYNERGIC MIG welding:

Display shows set value for wire feed speed and true value during welding.

Wire feed speed range is a wire type min. and max. speed.

SYNERGIC PULSED MIG welding:

Display shows set value for wire feed speed and true value during welding.

Wire feed speed range is a wire type min. and max. speed.

MMA welding: Display is blank at MMA welding.

I/A display

MIG/MAG welding with independent controls for wire feed speed and voltage: Display shows in setting state 0 A and true value during welding.

SYNERGIC MIG welding:

Display shows in setting state 0 A and true value during welding.

SYNERGIC PULSED MIG welding:

Display shows in setting state the reference mean current value and true value for welding current during welding.

MMA welding:

Display shows set value for MMA welding current 10 A...max. current of power source and true value during welding.

U/V display

MIG/MAG welding with independent adjustments for wire feed speed and voltage: Display shows set value for welding voltage and true value during welding.

SYNERGIC MIG welding:

Display shows set value for welding voltage and true value during welding.

By adjustment of arc length in display is shown adjustment value -9...0...9 for arc length, which is kept in display still for 3 s after end of adjustment.

SYNERGIC PULSMIG welding:

Display shows in setting state value -9...0...9 for arc length and during welding true value of welding voltage.

MMA welding:

Display shows in setting state open circuit voltage of power source and true value for MMA welding voltage during welding.

Note! Display shows terminal voltage of power source. Depending on length and copper cross-section of welding cables as well as on that of MIG guns real arc voltage and display might differ many volts from each other, see table below.

Cable	50 mm ²	70 mm ²	95 mm ²
Voltage loss / 10 m	0,35 V / 100 A	0,25 V / 100 A	0,18 V / 100 A

When you adjust welding dynamics, display shows adjustment value for welding dynamics -9...0...9 and value is kept on display still for approx. 3 s after end of adjustment. After that display is retrieved to show voltage in SYNERGIC MIG and MMA welding and arc length in SYNERGIC PULSED MIG welding.

3.2.1. WELD DATA

Retrieval of welding parameters to displays,

Use of WELD DATA switch retrieves to displays those welding parameters, wire feed speed, welding current, welding voltage which were used when welding was stopped last. Welding values are indicated in display for so long as you are using the WELD DATA switch and are kept in memory until you press again the start switch for gun.

Testing the gas flow

A short press on the switch starts the flow of the shielding gas. The shielding gas flows for approximately 20 seconds, or until the switch is pressed again.

3.2.2. SYNERGIC operations, ML panel

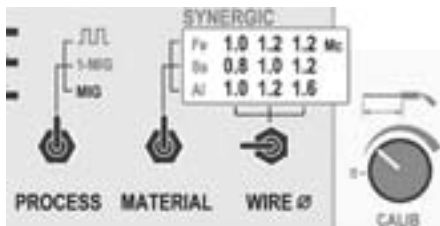

In SYNERGIC operation the operator tells the equipment the filler wire type and diameter which are used and the equipment generates on basis of these data optimal welding characteristics for wire in question. In SYNERGIC state adjustment for wire feed changes as adjustment for welding power and adjustment for voltage changes as adjustment for arc length (so called "one knob adjustment").

In SYNERGIC operation there are three operation modes:

MIG

Normal MIG/MAG welding with independent adjustments for wire feed speed and voltage. SYNERGIC operation is not in use.

1-MIG

SYNERGIC MIG welding with parameters which are optimized according to filler wire parameters. Nine SYNERGIC MIG programs for different filler wires are stored:

Filler wire	Shielding gas
Welding of steel	
∅ 1,0 mm, solid wire	75...82 % Ar + 25...18 % CO ₂
∅ 1,2 mm, solid wire	75...82 % Ar + 25...18 % CO ₂
∅ 1,2 mm, cored wire	75...82 % Ar + 25...18 % CO ₂
Note! 100 % CO ₂ is welded by setting welding dynamics to positions 8...9	
Welding of stainless steel	
∅ 0,8 mm, 307, 308, 309, 316	97,5...98 % Ar + 2,5...2 % CO ₂ /O ₂
∅ 1,0 mm, 307, 308, 309, 316	97,5...98 % Ar + 2,5...2 % CO ₂ /O ₂
∅ 1,2 mm, 307, 308, 309, 316	97,5...98 % Ar + 2,5...2 % CO ₂ /O ₂
Welding of aluminium	
∅ 1,0 mm, AlMg5, AlSi5	100 % Ar
∅ 1,2 mm, AlMg5, AlSi5, Al99,5	100 % Ar
∅ 1,6 mm, AlMg5, AlSi5, Al99,5	100 % Ar

In SYNERGIC MIG welding the welding values are adjusted with power potentiometer (normally potentiometer for wire feed speed), arc length potentiometers (normally voltage potentiometer) and welding dynamics potentiometer. Min. and max. power optimized for each wire correspond to min. and max. setting of power adjustment potentiometer. Set values connected with these min. and max. powers are shown in set value displays.

Compensating cable length

By compensation of cable length the voltage losses which arise in long interconnecting cables and different welding guns are taken into account. Cable compensation is adjusted as follows:

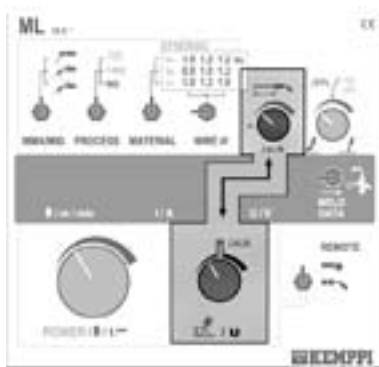

If interconnecting cables between wire feed unit and power source are not used, set cable compensation at position zero.

If the zero position doesn't operate as you want to, make adjustment check as described in following.

When using interconnecting cables, make as follows:

1. Adjust arc length at = CAL, which corresponds to normal arc length
2. Weld at power level wanted by you
3. Adjust with potentiometer for cable compensation a suitable arc length
4. Check adjustment range for arc length by adjusting arc length -9...0...9
5. When needed repeat points 2...4

Cable compensation is adjusted for each cable / MIG welding gun combination only once.



SYNERGIC PULSED MIG, pulsed MIG welding with parameters which are optimized according to filler wire parameters. Nine SYNERGIC PULSED MIG programs for different filler wires are stored:

Filler wire	Shielding gas
Pulsed MIG welding of steel	
∅ 1,0 mm, solid wire	75...82 % Ar + 25...18 % CO ₂
∅ 1,2 mm, solid wire	75...82 % Ar + 25...18 % CO ₂
∅ 1,2 mm, metal cored wire	75...82 % Ar + 25...18 % CO ₂
Note!	
CO ₂ -per cent: with PRO 3000 power source max. 2 % with PRO 4000, max. 10 %	
Pulsed MIG welding of stainless steel	
∅ 0,8 mm, 316, 308	97,5...98 % Ar + 2,5...2 % CO ₂ /O ₂
∅ 1,0 mm, 316, 308	97,5...98 % Ar + 2,5...2 % CO ₂ /O ₂
∅ 1,2 mm, 316, 308	97,5...98 % Ar + 2,5...2 % CO ₂ /O ₂
Pulsed MIG welding of aluminium	
∅ 1,0 mm, AlMg5, AlSi5	100 % Ar
∅ 1,2 mm, AlMg5, AlSi5, Al99,5	100 % Ar
∅ 1,6 mm, AlMg5, AlSi5, Al99,5	100 % Ar

In SYNERGIC PULSED MIG welding the welding values are adjusted with power potentiometer (normally potentiometer for wire feed speed), arc length potentiometers (normally voltage potentiometer) and welding dynamics potentiometer. Min. and max. power optimized for each wire correspond to min. and max. setting of power adjustment potentiometer. Set values connected with these min. and max. powers are shown in set value displays.

Compensating cable length

See the paragraph: "SYNERGIC MIG welding".

4. OPERATIONS OF REMOTE CONTROL UNITS IN PROMIG 530 WIRE FEED UNIT

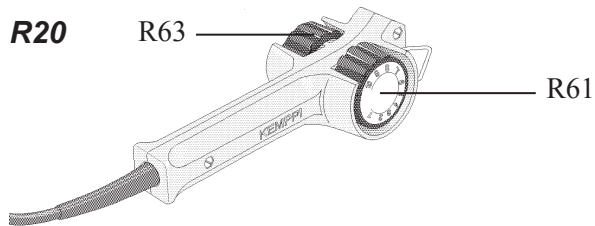

	R63	R61
MIG	Setting for wire feed: I 1...18 m/min II 1...25 m/min	Setting for voltage: 10 V...max. voltage of power source (35...46 V)
SELECTO	Channel selection: 1...5 corresponding to settings 1, 4, 6, 8, 10 of knob	Fine adjustment for arc length: 1...10
SYNERGIC MIG	Setting for power (wire feed speed): according to wire min. ... max.	Fine adjustment for arc length: 1...10
SYNERGIC PULSED MIG	Setting for power (wire feed speed): according to wire min. ... max.	Fine adjustment for arc length: 1...10
MMA	Setting for power: 10 A...max. power of power source	NO OPERATION

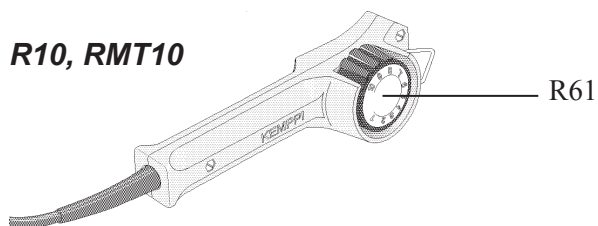

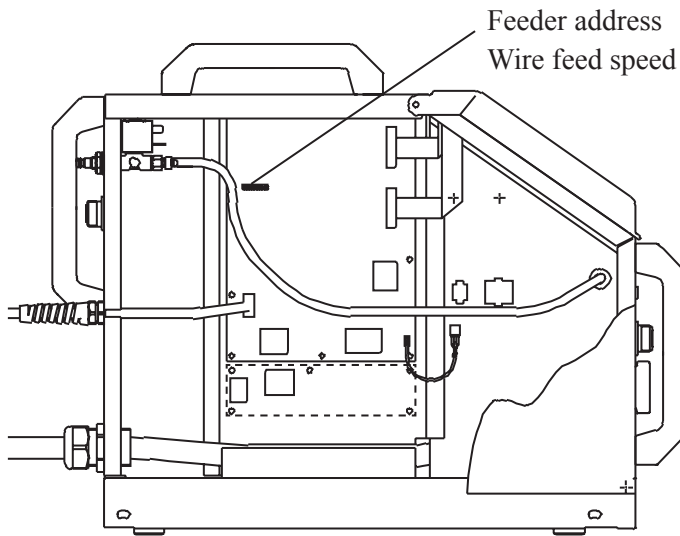

	R61	
MIG	Setting for wire feed: I 1...18 m/min II 1...25 m/min	
SELECTO	Channel selection: 1...5 corresponds in the R10 settings 1, 4, 6, 8, 10 of knob	
SYNERGIC MIG	Setting for power (wire feed speed): according to wire min. ... max.	
SYNERGIC PULSED MIG	Setting for power (wire feed speed): according to wire min. ... max.	
MMA	Setting for power: 10 A...max.power of power source	NOTE ! RMT10 NO OPERATION

5. PROMIG 530 A001 JUMPER BLOCK FUNCTIONS

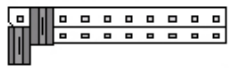

1. Selection of wire feeder address

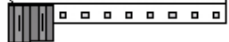
	Feeder 1, address 102
	Feeder 2, address 105
	Feeder 3, address 150
	Feeder 4, address 153

3. Welding with PROCool an air cooled MIG gun

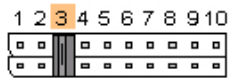
 COOLER is on, air/water cooling selection is air → welding stops after 1 s welding, Err 7 on display, on delivery

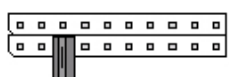
 COOLER is on, air/water cooling selection is air → welding is allowed (use e.g. with TIG/MIG sets)

4. Linearize output, wfs and voltage, as a function of control voltage

 Output is linear according to potentiometer turning angle, on delivery

 Output is linear according to control voltage: wfs: 0-5 V → 0-18,25 m/min, U2: 0-5 V → 0-50 V

5. Disable PMT and WS MIG guns

 PMT, WS and RMT10 functions enabled

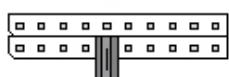
 PMT, WS and RMT10 functions disabler (Err11), only normal guns possible to use

6. Automatic remote -> local switching with MC, ML and MX panel

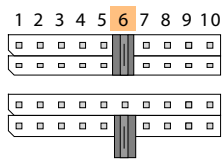

Remote -> local switching works, when remote controller is taken away
Remote -> local switching is off

7. Hot start function with MC and ML panel

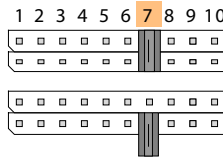

No hot start, on delivery
Hot start selected

8A. Crater filling in 4T with synergic MIG / PULSMIG, ML-panel only

8B. Selection of 2T or 4T with "no panel"

8C. Selection of crater filling with MC panel

8D. MX-panel selecto restores U-pot. value

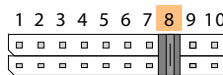

ML/MC-panel: No crater filling, on delivery
MX-panel selecto does not restore U-pot. value (fine control active)
2T MIG without panel

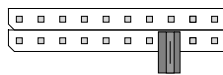

ML-panel: Crater filling in 4T with synergic PULSMIG/MIG
MC-panel: Crater filling in 4T
MX-panel selecto restores U-pot. value (no fine control)
4T MIG without panel

9A. Selection of synergic MIG / pulsed MIG, ML-panel

9B. Selection of plate thickness / amperage display, MX-panel

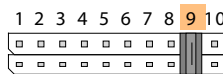

Fe synergic PULSMIG / MIG in ML panel, on delivery
Plate thickness display is on with MX-panel

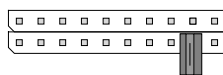

AlSi synergic PULSMIG / MIG in ML panel instead of Fe.
Extra label needed to change Fe text to AlSi text
Amperage display is on with MX-panel

10. Selection of max wire feed speed

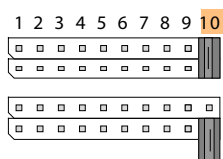

Max. speed 18 m/min, on delivery
Max. speed 25 m/min

6. ERROR CODES OF PANELS

By Promig 530 unit check by each start, if there are error states in the equipment; in case error states are observed, the error state in question is shown by means of Err textes appearing on (wire feed) display of panels (see enclosed figure).

Error codes are among others the following:

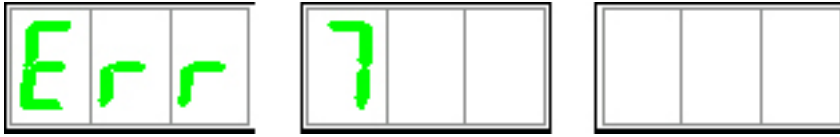

- Err 1: PROMIG has gone over to MMA welding, though you have already selected MMA welding on power source panel.
- Err 2: You are pressing on start switch of gun, when data transmission between PROMIG and PRO is broken (defect in control cable or in connector), or you are pressing on gun switch, when MMA welding has been selected on control panel of power source.
- Err 4: You are pressing on start switch of gun and selecting switch S12 for cooling mode of gun is in liquid position and you have forgotten to switch-on the PROCOOL cooling unit or you have forgotten to connect it to equipment.
- Err 5: PROCOOL cooling unit has stopped welding. Reason can be break of supply voltage from PROCOOL, pressure of liquid circulation doesn't arise or temperature of cooling liquid has arisen too high.
- Err 6: Wire feed unit has stopped welding in liquid position of selecting switch S12 of air/liquid-cooled gun for PROMIG, because data communication to cooling unit is broken (defect in intermediate cable or in connection).
- Err 7: Selecting switch S12 of air/liquid-cooled gun for PROMIG is in air position, PROCOOL is switched-on and start switch is pressed down. Purpose of operation is to prevent the liquid-cooled gun from being destroyed, if the selecting switch S12 for air/liquid-cooling is in wrong position.
- Err 8: Liquid-cooled PMT or WS gun is overheated.
- Err 9: Overload of wire feed motor, which can be caused e.g. by blocked wire guide of gun or by gun cable, which is too much curved.
- Err 10: Operation of thermal release of PRO power source has stopped welding.
- Err 11: You try to use the PMT or WS gun, when their use is prevented with the 5. jumper operation.
- Err 12: Welding has been stopped, because so colled door switch or gas guard has operated (operations need extra mountings to standard unit).

Eliminate the error codes as follows:

Error code Err 1 is eliminated when PROMIG wire feed system is set into MIG state.

Blinking of error codes Err 2-4 ends automatically within 5 s, if the trigger is not pressed down.

Eliminate the reason of error before next start.

Blinking of error codes Err 5-12 ends by next start, if the reason of error code has been eliminated.

7. SERVICE, OPERATION DISTURBANCES

The amount of use and the working environment should be taken into consideration when planning the frequency of maintenance of PROMIG. Careful use and preventive maintenance will help to ensure trouble-free operation.

The following maintenance operations should be carried out at least every six months:

Check:

- The wear of the grooves of the feed rolls. Excessive wear of grooves causes problems in wire feed.
- The wear of the wire guide tubes of wire feed. Badly worn feed rolls and wire guide tubes should be discarded.
- The wire guide tube in the gun should be set as near the feed rolls as possible, but not touching them and the wire must follow a straight line from the end of the tube to the groove of the feed roll.
- Reel brake adjustment.
- Electric connections
 - * Oxidized couplings must be cleaned
 - * Loose couplings must be tightened

Clean dust and dirt from the equipment.

 **When using compressed air, always protect your eyes with proper eye protection.**

In case of problems contact your KEMPPI dealer.

7.1. DISPOSAL OF THE MACHINE



Do not dispose of electrical equipment together with normal waste!

In observance of European Directive 2002/96/EC on Waste Electrical and Electronic Equipment and its implementation in accordance with national law, electrical equipment that has reached the end of its life must be collected separately and returned to an environmentally compatible recycling facility. As the owner of the equipment, you should get information on approved collection systems from our local representative.

By applying this European Directive you will improve the environment and human health!

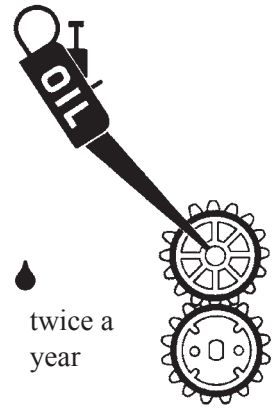

8. ORDERING NUMBERS

PROMIG 530		6232530
PRO Evolution 3200		6131320
PRO Evolution 4200		6131420
PRO Evolution 5200		6131520
P40		6185264
R10		6185409
R20		6185419
Shielding gas hose	1,5 m	4269030
Remote controlled interconnecting cable	10 m	6185481
Return current cable	5 m - 50 mm ²	6184511
Return current cable	5 m - 70 mm ²	6184711
Welding current cable	5 m - 50 mm ²	6184501
Welding current cable	5 m - 70 mm ²	6184701
Interconnecting cable set	10 m - 70 mm ²	6260313
Interconnecting cable set, liquid cooling	10 m - 70 mm ²	6260314
Cooling hose	0,95 m	4269340
Cooling hose	1,5 m	4269330
Cooling hose	2 m	4296990
Lift hook		4298180
Lock to cover		4299110
Hub for wire reel		4289880
Prosync 50		6263121
RMP 10		6185430
GH 10		6256010
GH 20		6256020
GH 30		6256030

MIG guns

Air-cooled:

PMT 32	3 m	6253213
PMT 32	4,5 m	6253214
PMT 35	3 m	6253513
PMT 35	4,5 m	6253514
PMT 42	3 m	6254213
PMT 42	4,5 m	6254214
MMT 32	3 m	6253213MMT
MMT 32	4,5 m	6253214MMT
MMT 35	3 m	6253513MMT
MMT 35	4,5 m	6253514MMT
MMT 42	3 m	6254213MMT
MMT 42	4,5 m	6254214MMT
KMP 300	6 m	6257306
KMP 300	10 m	6257310

Liquid-cooled:

PMT 30W	3 m	6253043
PMT 30W	4,5 m	6253044
PMT 42W	3 m	6254203
PMT 42W	4,5 m	6254204
PMT 52W	3 m	6255203
PMT 52W	4,5 m	6255204
MMT 30W	3 m	6253043MMT
MMT 30W	4,5 m	6253044MMT
MMT 42W	3 m	6254203MMT
MMT 42W	4,5 m	6254204MMT
MMT 52W	3 m	6255203MMT
MMT 52W	4,5 m	6255204MMT
KMP 400W	6 m	6257406
KMP 400W	10 m	6257410
WS 30W (Al 1.2-1.6)	6 m	6253046A12
WS 30W (SS 1.0)	6 m	6253046S10
WS 30W (SS 1.2)	6 m	6253046S12
WS 30W (Al 1.2-1.6)	8 m	6253048A12
WS 30W (SS 1.0)	8 m	6253048S10
WS 30W (SS 1.2)	8 m	6253048S12
WS 42W (Al 1.2-1.6)	6 m	6254206A12
WS 42W (SS 1.0)	6 m	6254206S10
WS 42W (SS 1.2)	6 m	6254206S12
WS 42W (Al 1.2-1.6)	8 m	6254208A12
WS 42W (SS 1.0)	8 m	6254208S10
WS 42W (SS 1.2)	8 m	6254208S12

9. TECHNICAL DATA

Promig 530		
Working voltage (safety voltage)		50 VDC
Max. load (nominal values)		100 W
Kuormitettavuus (nimellisarvot)		
	60 % ED	520 A
	100 % ED	440 A
Operation principle		4 roll feed
Diameter of feed roll		32 mm
Wire feed speed I		0...18 m/min
Wire feed speed II 1)		0...25 m/min
Filler wires	∅ Fe, Ss	0,6...2,4
	∅ Cored wire	0,8...2,4
	∅ Al	1,0...2,4
Wire reel	max. weight	20 kg
	max. size	∅ 300 mm
Gun connector		Euro
Operation temperature range		-20...+40 °C
Storage temperature range		-40...+60 °C
Degree of protection		IP 23 C
Dimensions without handles	length	640 mm
	width	230 mm
	height	430 mm
Weight		21 kg
1) Changes of speed are carried out by changing gear wheel and jumber block selection on circuit card A001.		

Control panels		
	MC 6263501	ML 6263502
Adjustment for welding current, voltage and wire feed speed	Potentiometers	Potentiometers
Welding current, voltage and wire feed speed displays	LED displays	LED displays
Measuring recording to memory, recall of welding parameters (WPS)	yes	yes
MIG/MMA dynamics control	Potentiometer	Potentiometer
Selecto memory channels	5 pc	
Synergic MIG	-	9 programs
Synergic PULSED MIG	-	9 programs

The products meet conformity requirements for CE marking.

10. TERMS OF GUARANTEE

Kemppi Oy provides a guarantee for products manufactured and sold by them if defects in manufacture and materials occur. Guarantee repairs must be carried out only by an Authorised Kemppi Service Agent. Packing, freight and insurance costs to be paid by orderer. The guarantee is effected on the date of purchase. Verbal promises which do not comply with the terms of guarantee are not binding on guarantor.

Limitations on guarantee

The following conditions are not covered under the terms of guarantee: defects due to natural wear and tear, non-compliance with operating and maintenance instructions, connection to incorrect or faulty supply voltage (including voltage surges outside equipment spec.), incorrect gas pressure, overloading, transport or storage damage, fire or damage due to natural causes i.e. lightning or flooding.

This guarantee does not cover direct or indirect travelling costs, daily allowances or accommodation.

Note: Under the terms of guarantee, welding torches and their consumables, feeder drive rolls and feeder guide tubes are not covered. Direct or indirect damage due to a defective product is not covered under the guarantee. The guarantee is void if changes are made to the product without approval of the manufacturer, or if repairs are carried out using non-approved spare parts.

The guarantee is also void if repairs are carried out by non-authorised agents.

Undertaking guarantee repairs

Guarantee defects must be informed to Kemppi or authorised Kemppi Service Agents within the guarantee period. Before any guarantee work is undertaken, the customer must provide proof of guarantee or proof of purchase, and serial number of the equipment in order to validate the guarantee. The parts replaced under the terms of guarantee remain the property of Kemppi.

Following the guarantee repair, the guarantee of the machine or equipment, repaired or replaced, will be continued to the end of the original guarantee period.

KEMPPi OY
PL 13
FIN – 15801 LAHTI
FINLAND
Tel (03) 899 11
Telefax (03) 899 428
www.kemppi.com

KEMPPiKONEET OY
PL 13
FIN – 15801 LAHTI
FINLAND
Tel (03) 899 11
Telefax (03) 7348 398
e-mail: myynti.fi@kemppi.com

KEMPPi SVERIGE AB
Box 717
S – 194 27 UPPLANDS VÄSBY
SVERIGE
Tel (08) 590 783 00
Telefax (08) 590 823 94
e-mail: sales.se@kemppi.com

KEMPPi NORGE A/S
Postboks 2151, Postterminalen
N – 3103 TØNSBERG
NORGE
Tel 33 34 60 00
Telefax 33 34 60 10
e-mail: sales.no@kemppi.com

KEMPPi DANMARK A/S
Literbuen 11
DK – 2740 SKOVLUNDE
DANMARK
Tel 44 941 677
Telefax 44 941 536
e-mail:sales.dk@kemppi.com

KEMPPi BENELUX B.V.
Postbus 5603
NL – 4801 EA BREDA
NEDERLAND
Tel +31 (0)76-5717750
Telefax +31 (0)76-5716345
e-mail: sales.nl@kemppi.com

KEMPPi (UK) Ltd
Martti Kemppi Building
Fraser Road
Priory Business Park
BEDFORD, MK443WH
ENGLAND
Tel 0845 6444201
Fax 0845 6444202
e-mail: sales.uk@kemppi.com

KEMPPi FRANCE S.A.
65 Avenue de la Couronne des Prés
78681 EPONE CEDEX
FRANCE
Tel (01) 30 90 04 40
Telefax (01) 30 90 04 45
e-mail: sales.fr@kemppi.com

KEMPPi GmbH
Otto – Hahn – Straße 14
D – 35510 BUTZBACH
DEUTSCHLAND
Tel (06033) 88 020
Telefax (06033) 72 528
e-mail:sales.de@kemppi.com

KEMPPi SP. z o.o.
Ul. Piłsudskiego 2
05-091 ZĄBKI
Poland
Tel +48 22 781 6162
Telefax +48 22 781 6505
e-mail: info.pl@kemppi.com

KEMPPi WELDING
MACHINES AUSTRALIA PTY LTD
P.O. Box 404 (2/58 Lancaster Street)
Ingleburn NSW 2565, Australia
Tel. +61-2-9605 9500
Telefax +61-2-9605 5999
e-mail: info.au@kemppi.com